

Automation for a Changing World

Delta AC Servo Drive & Motor ASDA-B2 Series



www.deltaww.com

 **DELTA**
Smarter. Greener. Together.

High Precision. High Response. Cost Effective.

The high-performance, cost-effective ASDA-B2 Series servo motors and drives meet the requirements for general-purpose machine control applications in the industrial automation market and enhance the competitive advantage of servo systems.

The power rating of the ASDA-B2 Series ranges from 0.1kW to 3kW. The superior features of this series emphasize built-in motion control functions for general purpose applications and saving the cost of mechatronics integration. Delta's ASDA-B2 makes setting assembly, wiring, and operation convenient. In switching from other brands to Delta's ASDA-B2, the outstanding quality and features, and complete product lineup makes replacement simple and scalable. Customers that choose this value-based product gain noticeable competitive advantages in their market space. All of Delta's ASDA-B2 Series meet UL, cUL, CE, and RoHS standards.

Transporting and Conveying Equipment



Electric Discharge Machines (EDM)



Cutting Machines

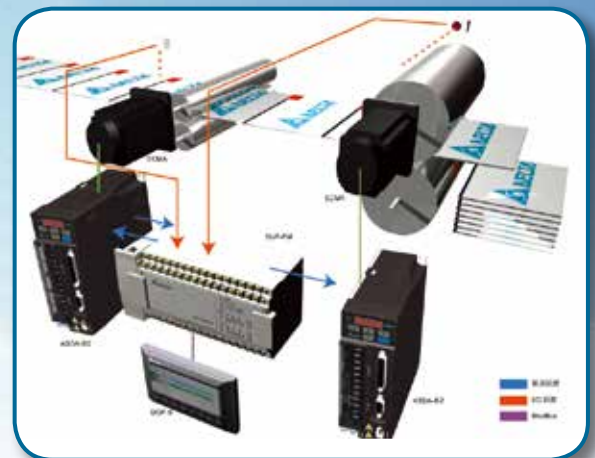

Product Features

Implements High Precision Positioning Control

- ▶ ASDA-B2 Series servo drive supports 20-bit and 17-bit encoders. It satisfies the demand for high-precision positioning control and stable operation with lower speed.
- ▶ Applying the encoder with a higher resolution can reduce the cogging torque and improve the motor's precision.

2500ppr of Torque Ripple

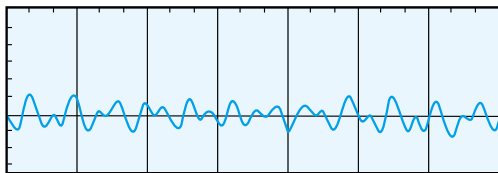

17-bit of Torque Ripple

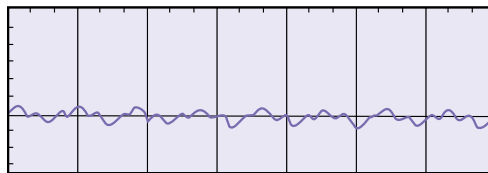

- ▶ Outstanding performance with higher speed: Up to 550Hz frequency response and settling time is below 1ms.
- ▶ 10ms acceleration time from -3000r/min to 3000r/min when running without a load.

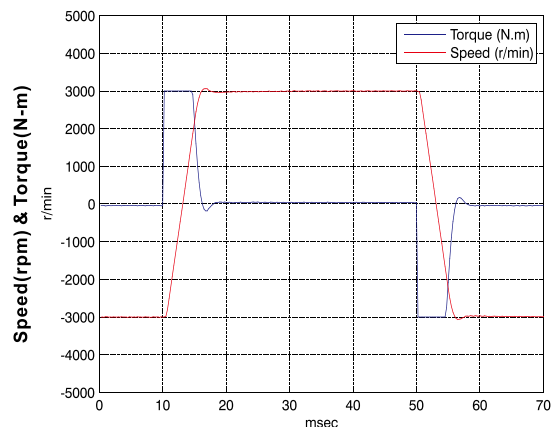
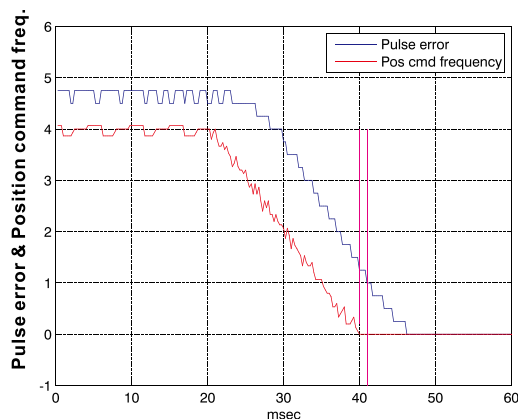

Example: Frame size 60mm and 400W servo motor.

Satisfies a Variety of Industry Requirements

- ▶ Three control modes available: Built-in position, Speed, and Torque. (Speed and Torque mode can be controlled by internal parameters or analog voltage.)
- ▶ High-speed differential command (up to 4Mpps) for high precision positioning control.
- ▶ Three notch filters are provided to suppress the mechanical resonance efficiently and make the system operate more smoothly.
- ▶ Lead friction compensation parameter is specified for the application of circular interpolation, Z-axis motion and ball screw, and others to reduce the loading of the controller.
- ▶ For bar feeders and other equipment requiring high torque output, motor protection parameters are offered to protect the mechanical system.

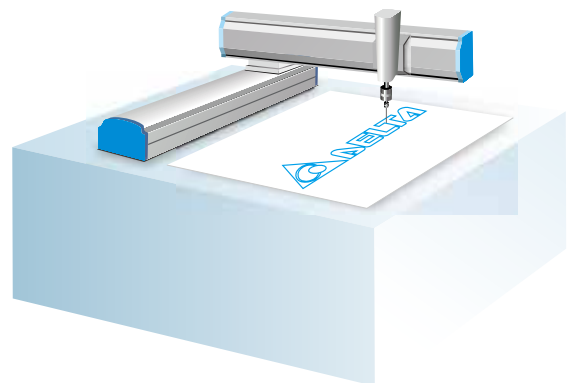

Offers Easy-To-Install Solution For Simple Start-Up

Separated power supply for main circuit and control circuit



- ▶ ASDA-B Series share the same power cables and encoder cables for easy installation and setup without extra accessories.
- ▶ Servo motor provides brake, oil seal, and other optional configurations for different applications.
- ▶ Separated power supply for main circuit and control circuit makes it easier to maintain the mechanism.
- ▶ 400W or above servo drives have built-in regenerative resistors, which simplify wiring and reduce the installation cost.
- ▶ Individual connectors (2 sets) for analog signal output, also simplifies the wiring.

MON1
MON2

Supports two analog outputs

Fulfills Easy-To-Use Requirements For Versatile Operation

- ▶ User-friendly motor sizing software allows users to select the motor.
- ▶ ASDA-Soft configuration software (tuning software) is provided to meet performance requirements quickly.
- ▶ Easy-to-use digital keypad is ideal for setting parameters and enables users to directly monitor the servo drive and servo motor.
- ▶ Specific software communication cable ASD-CNUS0A08 (Optional) can improve communication quality and convenience of operation. (please refer to optional accessories on page 28)

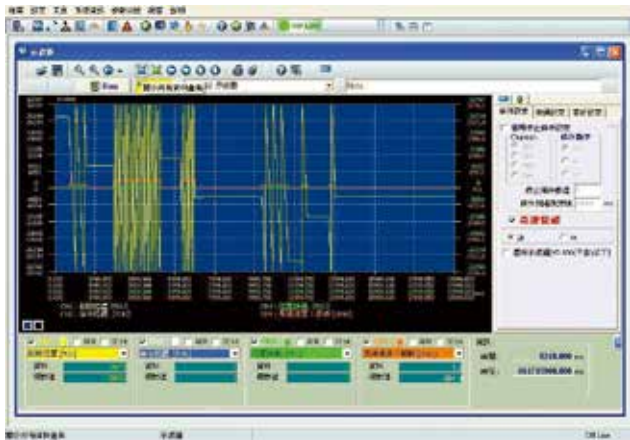
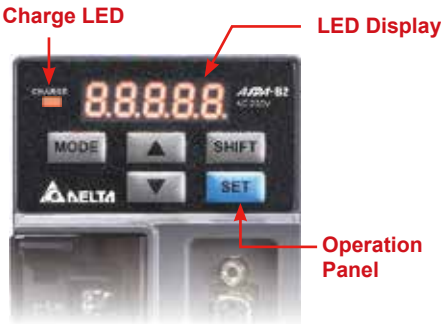

参数号	名称	数据类型	范围	分辨率	默认值	备注
PA_01	频率	频率	0~1000	1	50	最高频率
PA_02	速度	速度	0~10000	1	1000	最高速度
PA_03	位置	位置	0~1000000	1	0	最高位置
PA_04	速度反馈增益	速度反馈增益	0~10000	1	1000	速度反馈增益
PA_05	速度反馈常数	速度反馈常数	0~10000	1	1000	速度反馈常数
PA_06	速度反馈常数	速度反馈常数	0~10000	1	1000	速度反馈常数
PA_07	速度反馈常数	速度反馈常数	0~10000	1	1000	速度反馈常数
PA_08	速度反馈常数	速度反馈常数	0~10000	1	1000	速度反馈常数
PA_09	速度反馈常数	速度反馈常数	0~10000	1	1000	速度反馈常数
PA_10	速度反馈常数	速度反馈常数	0~10000	1	1000	速度反馈常数
PA_11	速度反馈常数	速度反馈常数	0~10000	1	1000	速度反馈常数
PA_12	速度反馈常数	速度反馈常数	0~10000	1	1000	速度反馈常数
PA_13	速度反馈常数	速度反馈常数	0~10000	1	1000	速度反馈常数
PA_14	速度反馈常数	速度反馈常数	0~10000	1	1000	速度反馈常数
PA_15	速度反馈常数	速度反馈常数	0~10000	1	1000	速度反馈常数
PA_16	速度反馈常数	速度反馈常数	0~10000	1	1000	速度反馈常数
PA_17	速度反馈常数	速度反馈常数	0~10000	1	1000	速度反馈常数
PA_18	速度反馈常数	速度反馈常数	0~10000	1	1000	速度反馈常数
PA_19	速度反馈常数	速度反馈常数	0~10000	1	1000	速度反馈常数
PA_20	速度反馈常数	速度反馈常数	0~10000	1	1000	速度反馈常数

- ▶ On-line monitoring function for 4 channels (similar to a digital oscilloscope) is available. The monitoring data can be 16-bit (4 channels) and 32-bit (2 channels).

- ▶ Multi-functional parameter editor enables users to edit, modify, upload/download and print desired parameters in real time.



Model Name Explanation

ASDA-B2 Series Servo Drives

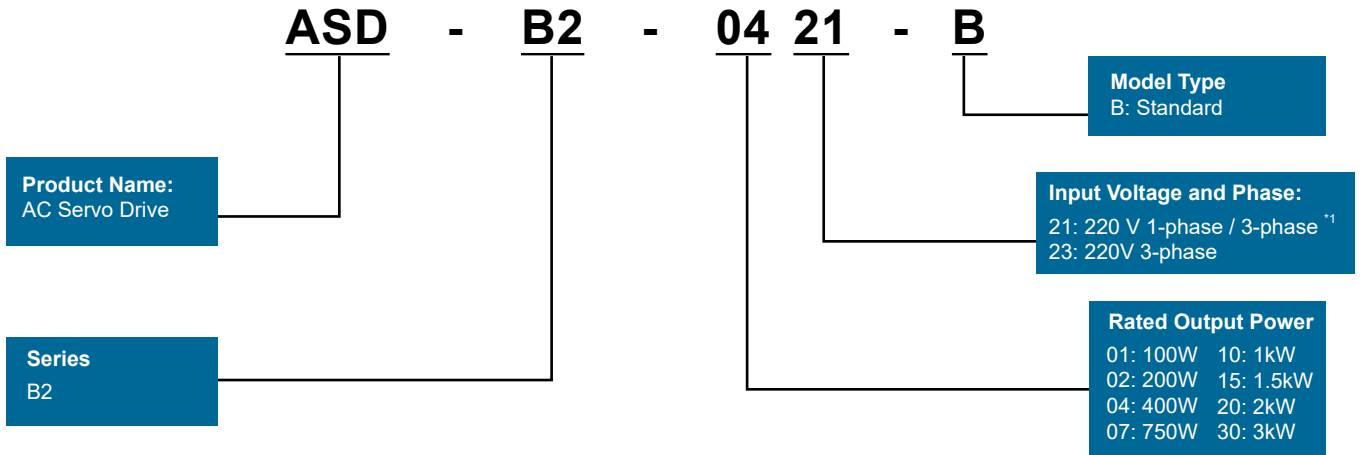

NOTE 1. Rated power of 100W to 1.5kW are marked number 21 with 220V, single-phase and three-phase connections

ECMA Series Servo Motors

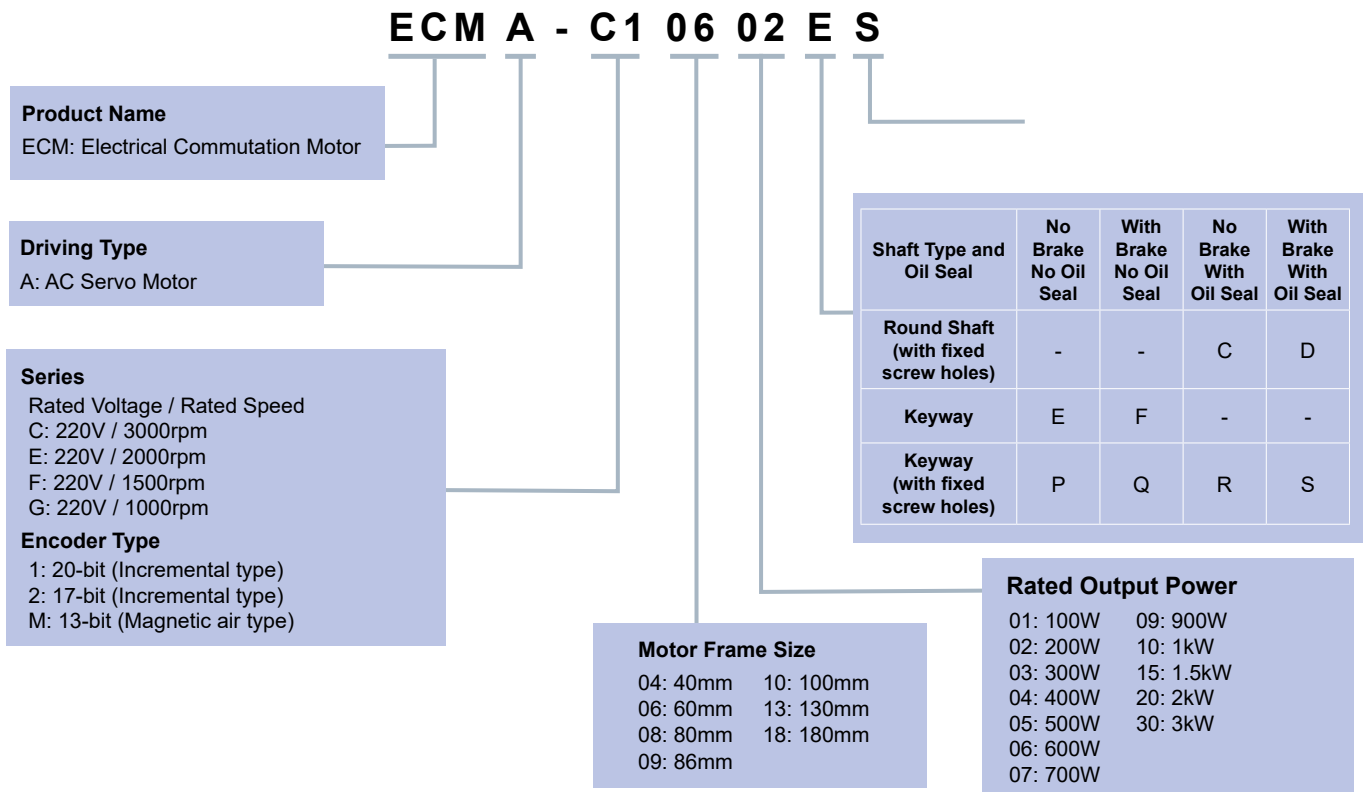

Product Line-up

Servo Drive								
	0.1kW	200W	400W	750W	1.0kW	1.5kW	2kW	3kW
	ASD-B2-0121- B	ASD-B2-0221- B	ASD-B2-0421- B	ASD-B2-0721-B	ASD-B2-1021-B	ASD-B2-1521-B	ASD-B2-2023-B	ASD-B2-3023- B

Servo Motor																
	ECMA-C-0401□S	ECMA-C-0602□S	ECMA-C-0604□S ECMA-C-0604□H ECMA-C-0804□7 ECMA-E-1305□S ECMA-G-1303□S	ECMA-C-0807□S ECMA-C-0807□H ECMA-G-1306□S ECMA-GM1306PS ECMA-C-0907□S	ECMA-C-1010□S ECMA-E-1310□S ECMA-G-1309□S ECMA-GM1309PS ECMA-C-0910□S ECMA-F-1308□S	ECMA-E-1315□S	ECMA-C-1020□S ECMA-F-1313□S ECMA-E-1320□S ECMA-E-1820□S ECMA-F-1318□S	ECMA-E-1830□S ECMA-F-1830□S ECMA-E-1835□S ECMA-C-1330□4								

Note:
 1. (□) in the model names represent shaft end/brake or the number of oil seals.
 2. (Δ) in the model names represent encoder types (Δ =1: Incremental encoder, 20-bit; Δ =2: Incremental encoder, 17-bit).

Part Names and Functions

LED Display

- The 5-digit, 7-segment LED displays the servo status or fault codes.

Charge LED

- A lit LED indicates that either power is connected to the servo drive or a residual charge is present in the drive's internal power components.

Operation Panel

- Function keys used to perform status display, monitor and diagnostic, function and parameter setting.

Function Keys:

MODE: Mode selection

SHIFT: For shifting the cursor to the left

▲ : For increasing values

▼ : For decreasing values

SET: For storing data

Control Circuit Terminal (L1c, L2c)

- Used to connect 200~230 V_{AC}, 50/60Hz single-phase or three-phase V_{AC} supply.

Main Circuit Terminal (R, S, T)

- Used to connect 200~230 V_{AC}, 50/60Hz commercial power supply.

Servo Motor Output (U, V, W)

- Used to connect the servo motor. Never connect the output terminal to the main circuit power as the AC servo drive may be damaged beyond repair if incorrect cables are connected to the output terminals.

Regenerative Resistor

1. When using an external resistor, connect it to P ⊕ and C, and ensure an open circuit between P ⊕ and D.
2. When using an internal resistor, ensure the circuit is closed between P ⊕ and D, and the circuit is open between P ⊕ and C
3. When using external braking unit, connect braking unit to P ⊕ and ⊖, and ensure an open circuit between P ⊕ and D, and P ⊕ and C.

Ground Terminal



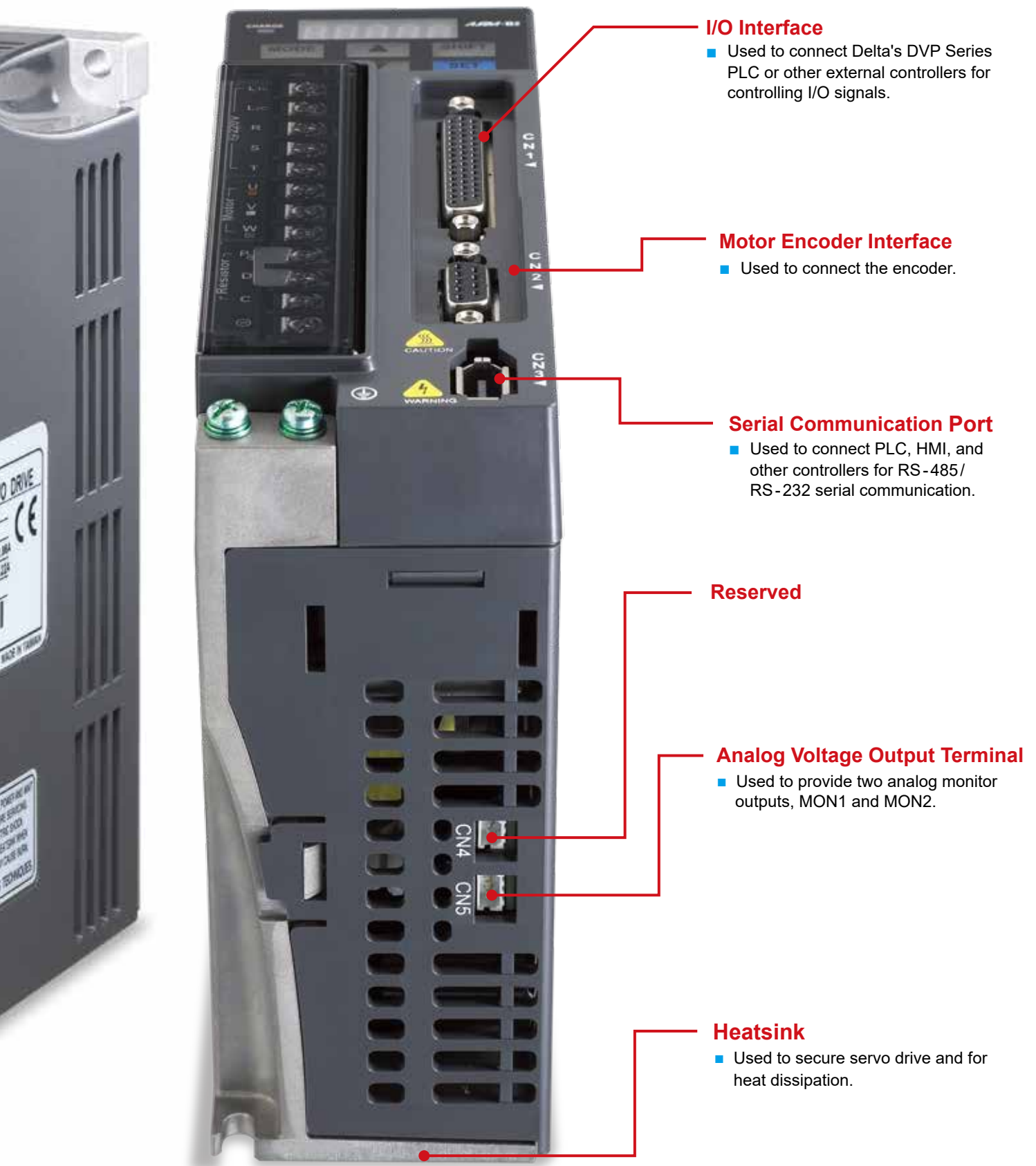

I/O Interface

- Used to connect Delta's DVP Series PLC or other external controllers for controlling I/O signals.

Motor Encoder Interface

- Used to connect the encoder.

Serial Communication Port

- Used to connect PLC, HMI, and other controllers for RS-485/RS-232 serial communication.

Reserved

Analog Voltage Output Terminal

- Used to provide two analog monitor outputs, MON1 and MON2.

Heatsink

- Used to secure servo drive and for heat dissipation.



NOTE

Please note that this only introduces a servo drive's basic functions. Specific models may have different functions.

Wiring

Position (Pt) Control Mode (for Pulse Command Input)

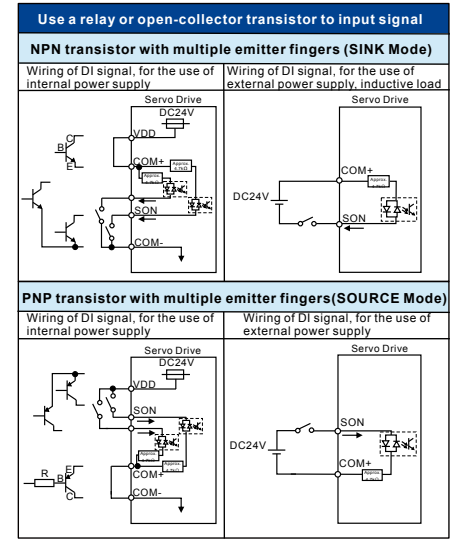
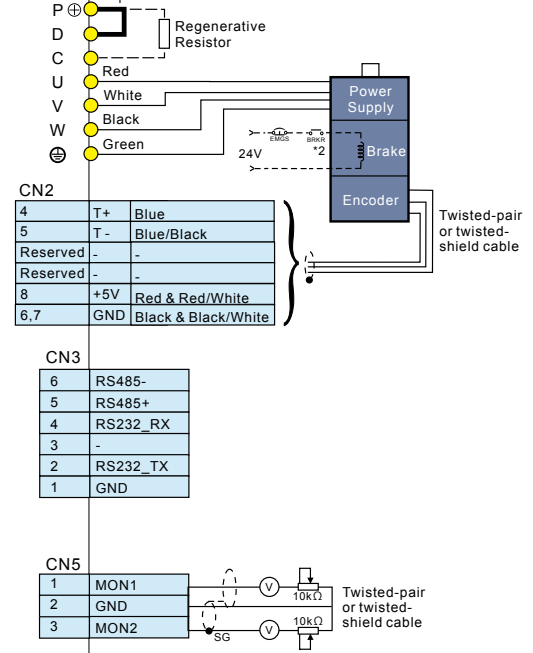
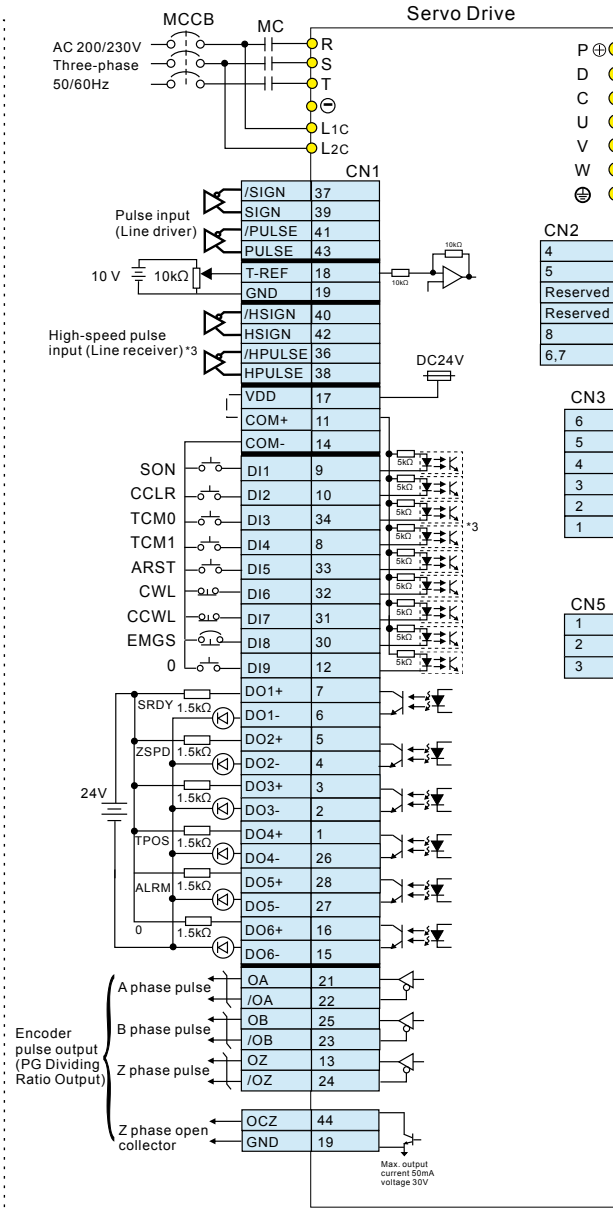
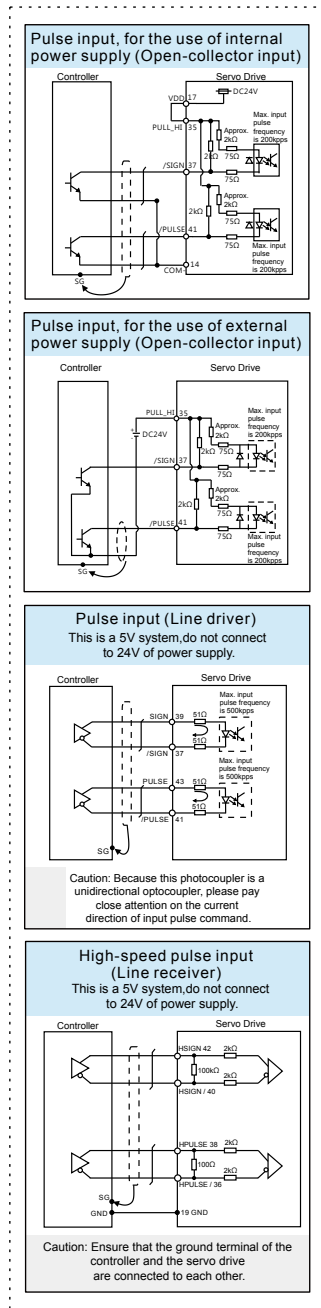

NOTE:
 *1. 200W and below drives do not provide built-in regenerative resistor.
 *2. The brake coil has no polarity.
 *3. Please refer to SINK / SOURCE modes

WARNING Caution: Do not use dual power supply. Failure to observe this caution may damage the servo drive.

Speed (S) Control Mode

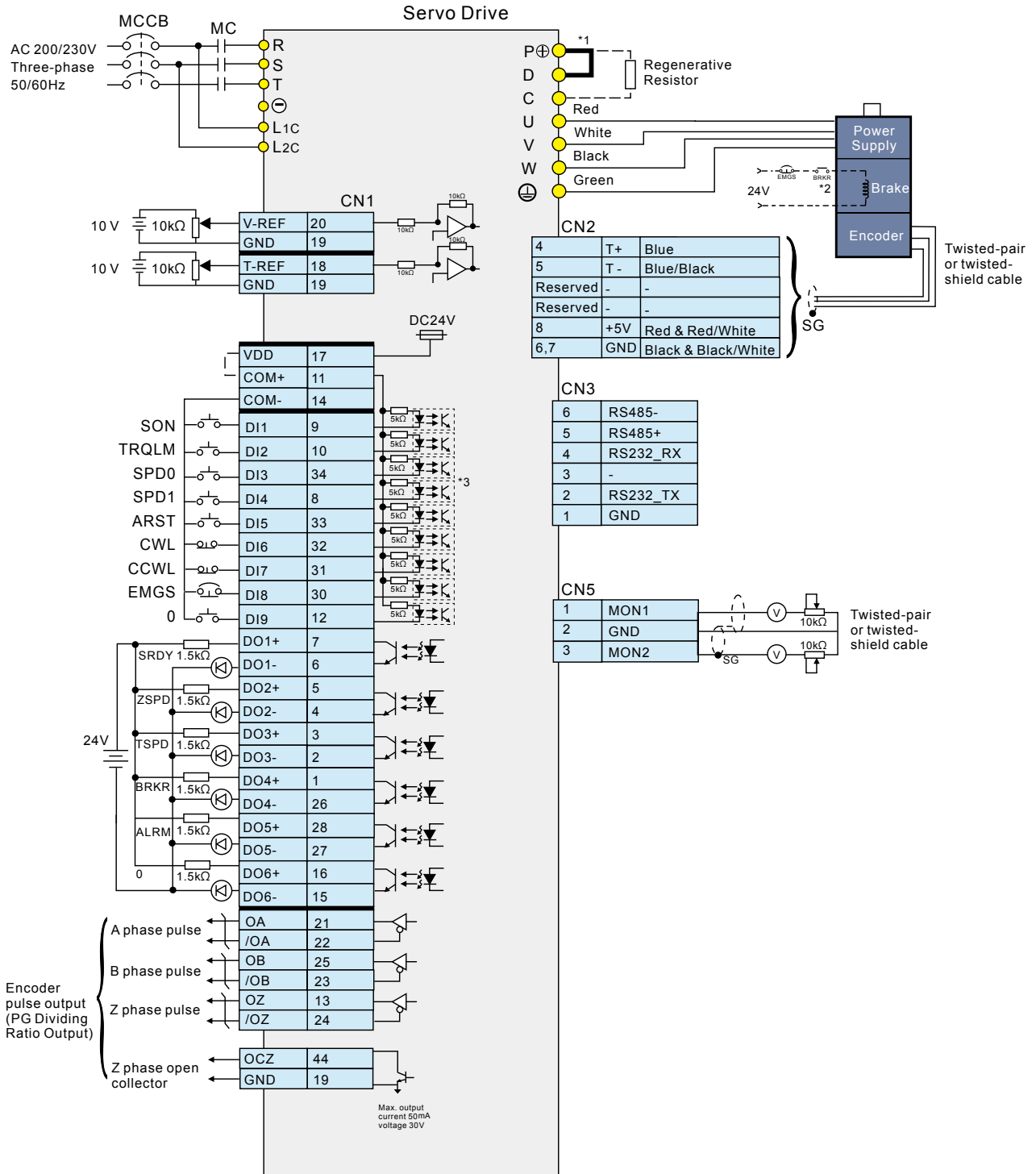

NOTE:
 *1. 200W and below drives do not provide built-in regenerative resistor.
 *2. The brake coil has no polarity.
 *3. Please refer to SINK / SOURCE modes

Wiring

Torque (T) Control Mode

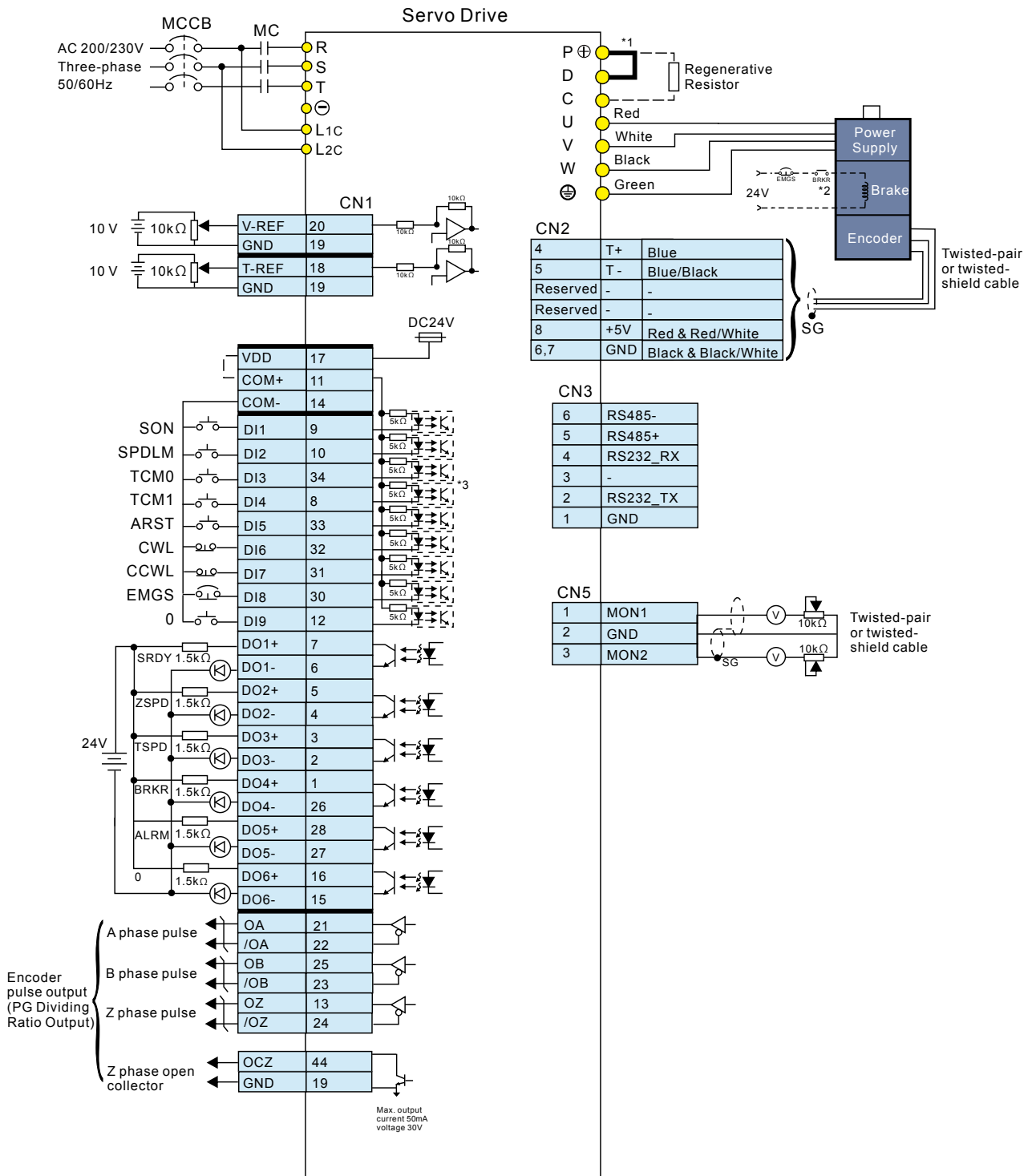

NOTE:
 *1. 200W and below drives do not provide built-in regenerative resistor.
 *2. The brake coil has no polarity.
 *3. Please refer to SINK / SOURCE modes

Selection of Regenerative Resistor

Servo Drive (kW)	Recommended Specifications for Built-in Regenerative Resistor		The capacity of built-in regenerative resistor (Watt)	Min. Allowable Resistance (Ohm)
	Resistance (Ohm) (parameter P1-52)	Capacity (Watt) (parameter P1-53)		
0.1	--	--	--	60Ω
0.2	--	--	--	60Ω
0.4	100Ω	60W	30W	60Ω
0.75	100Ω	60W	30W	60Ω
1.0	40Ω	60W	30W	30Ω
1.5	40Ω	60W	30W	30Ω
2.0	20Ω	100W	50W	15Ω
3.0	20Ω	100W	50W	15Ω





Note:

- 1) 100W ~ 200W of B2 servo drives have no built-in regenerative resistor.
- 2) When the fault, ALE05 (Regeneration Error) occurs, please increase the regenerative resistor capacity or decrease the regenerative resistor resistance (the regenerative resistor resistance should not be less than the minimum allowable resistance listed in the above table.)
- 3) If the issue persists, please purchase a regenerative resistor module.
- 4) When connecting to a regenerative resistor in parallel, make sure that the total resistance value of the regenerative resistors is not less than the minimum allowable resistance listed in the above table.

Specifications

ASDA-B2 Series		100 W	200 W	400 W	750 W	1 kW	1.5 kW	2 kW	3 kW
		01	02	04	07	10	15	20	30
Power Supply	Phase / Voltage	Three-phase 170 ~ 255 V _{AC} , 50/60 Hz ±5%						Three - phase 170 ~ 255 V _{AC} , 50/60 Hz ±5%	
		Single-phase 200 ~ 255 V _{AC} , 50/60 Hz ±5%							
	Input Current (3PH) (Units: Arms)	0.39	1.11	1.86	3.66	4.68	5.9	8.76	9.83
	Input Current (1PH) (Units: Arms)	0.69	1.92	4.5	6.78	8.88	10.3	-	-
	Continuous Output Current (Units: Arms)	0.9	1.55	2.6	5.1	7.3	8.3	13.4	19.4
Cooling System		Natural Air Circulation				Fan Cooling			
Encoder Resolution		17-bit (160,000 p/rev)							
Main Circuit Control		SVPWM (Space Vector Pulse Width Modulation) Control							
Control Mode		Auto / Manual							
Regenerative Resistor		None			Built-in				
Position Control Mode	Max. Input Pulse Frequency	Transmitted by differential: 500 K (low speed) / 4 Mpps (high-speed) Transmitted by open-collector: 200 Kpps							
	Pulse Type	Pulse + Direction, A phase + B phase, CCW pulse + CW pulse							
	Command Source	External pulse							
	Smoothing Strategy	Low-pass filter							
	E-gear Ratio	Electronic gear N/M multiple N: 1 ~ (2 ²⁶ -1) / M: 1 ~ (2 ³¹ -1) (1/50 < N/M < 25600)							
	Torque Limit Operation	Set by parameters							
	Feed Forward Compensation	Set by parameters							
Speed Control Mode	Analog Input Command	Voltage Range	0 ~ ±10 V _{DC}						
		Input Resistance	10 KΩ						
		Time Constant	2.2 μs						
	Speed Control Range ^{*1}	1:5000							
	Command Source	External analog signal / Internal parameters							
	Smoothing Strategy	Low-pass and S-curve filter							
	Torque Limit	Set by parameters or via analog input							
	Bandwidth	Maximum 550 Hz							
Speed Accuracy ^{*2}	±0.01% at 0 to 100% load fluctuation								
	±0.01% at ±10% power fluctuation								
	±0.01% at 0 °C to 50 °C ambient temperature fluctuation								

Specifications

ASDA-B2 Series		100 W	200 W	400 W	750 W	1 kW	1.5 kW	2 kW	3 kW
		01	02	04	07	10	15	20	30
Torque Control Mode	Analog Input Command	Voltage Range	0 ~ ±10 V _{DC}						
		Input Resistance	10 KΩ						
		Time Constant	2.2 μs						
	Command Source	External analog signal / Internal parameters							
	Smoothing Strategy	Low-pass filter							
	Speed Limit	Set by parameters or via analog input							
Analog Monitor Output		Monitor signal can set by parameters (Output voltage range: ±8 V)							
Digital Input / Output	Input	Servo on, Fault reset, Gain switch, Pulse clear, Zero clamp, Command input reverse control, Torque limit, Speed limit, Speed command selection, Speed/position mode switching, Speed/torque mode switching, Torque/position mode switching, Emergency stop, Positive/negative limit, Forward/reverse operation torque limit, Forward/reverse JOG input, E-gear N selection, Pulse input prohibition							
	Output	Encoder signal output (A, B, Z Line Driver / Z Open collector) Servo on, Servo ready, Zero speed, Target speed reached, Target position reached, Torque limiting, Servo alarm, Brake control, Early warning for overload, Servo warning							
Protective Functions		Over current, Overvoltage, Under voltage, Overheat, Excessive speed deviation, Excessive position deviation, Encoder error, Emergency stop, Communication error, Short-circuit protection of terminal U, V, W and CN1, CN2, CN3							
Communication Interface		RS-232 / RS-485							
Environment	Installation Site	Indoor location (avoid direct sunlight), no corrosive liquid and gas (avoid oil mist, flammable gas, dust)							
	Altitude	Altitude 2000 m or lower above sea level							
	Atmospheric Pressure	86 kPa ~ 106 kPa							
	Operating Temperature	0°C ~ 55°C (If operating temperature is above 45°C, forced cooling will be required)							
	Storage Temperature	-20°C ~ 65°C (-4°F to 149°F)							
	Humidity	0 to 90% (non-condensing)							
	Vibration	Under 20 Hz, 9.80665 m/s ² (1G), 20 ~ 50 Hz 5.88 m/s ² (0.6 G)							
	IP Rating	IP20							
	Power System	TN System ³							
	Certifications	IEC/EN 61800-5-1    							

Footnote:

*1. When it is in rated load, the speed ratio is: the minimum speed (smooth operation) / rated speed.

*2. When the command is the rated speed, the velocity correction ratio is: (rotational speed with no load - rotational speed with full load) / rated speed.

*3. TN system: The neutral point of the power system connects to the ground directly. The exposed metal components connect to the ground via the protective earth conductor.



Dimensions

ASD-B2-0121
ASD-B2-0221
ASD-B2-0421
(100 W / 200 W / 400 W)

Weight
 1.07 (2.36)

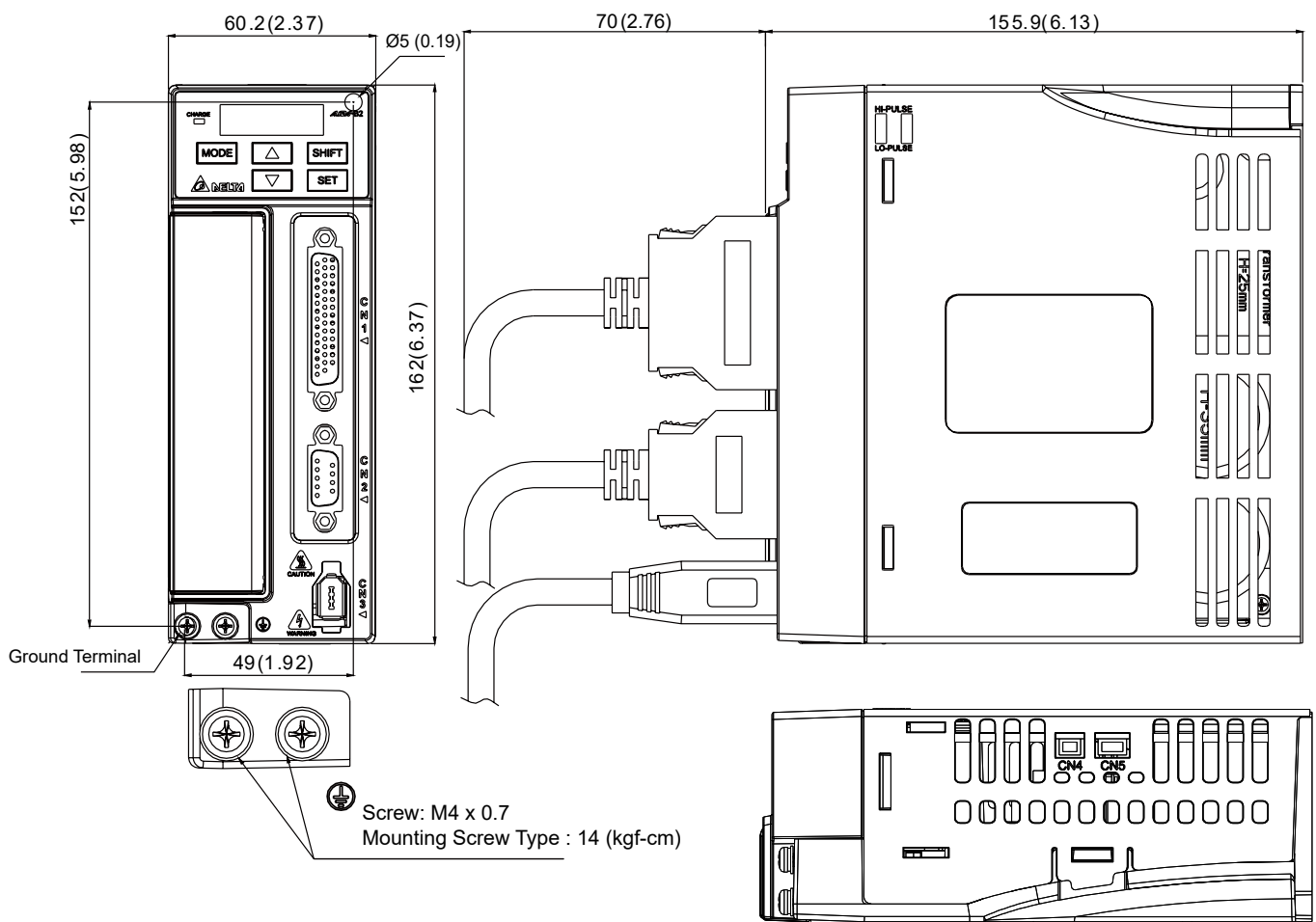

NOTE

- 1) Dimensions are in millimeters (inches); Weights are in kilograms (kg) and pounds (lbs).
- 2) Dimensions and weights of the servo drive may be updated without prior notice.

ASD-B2-0721 (750W)

Weight
1.54 (3.40)

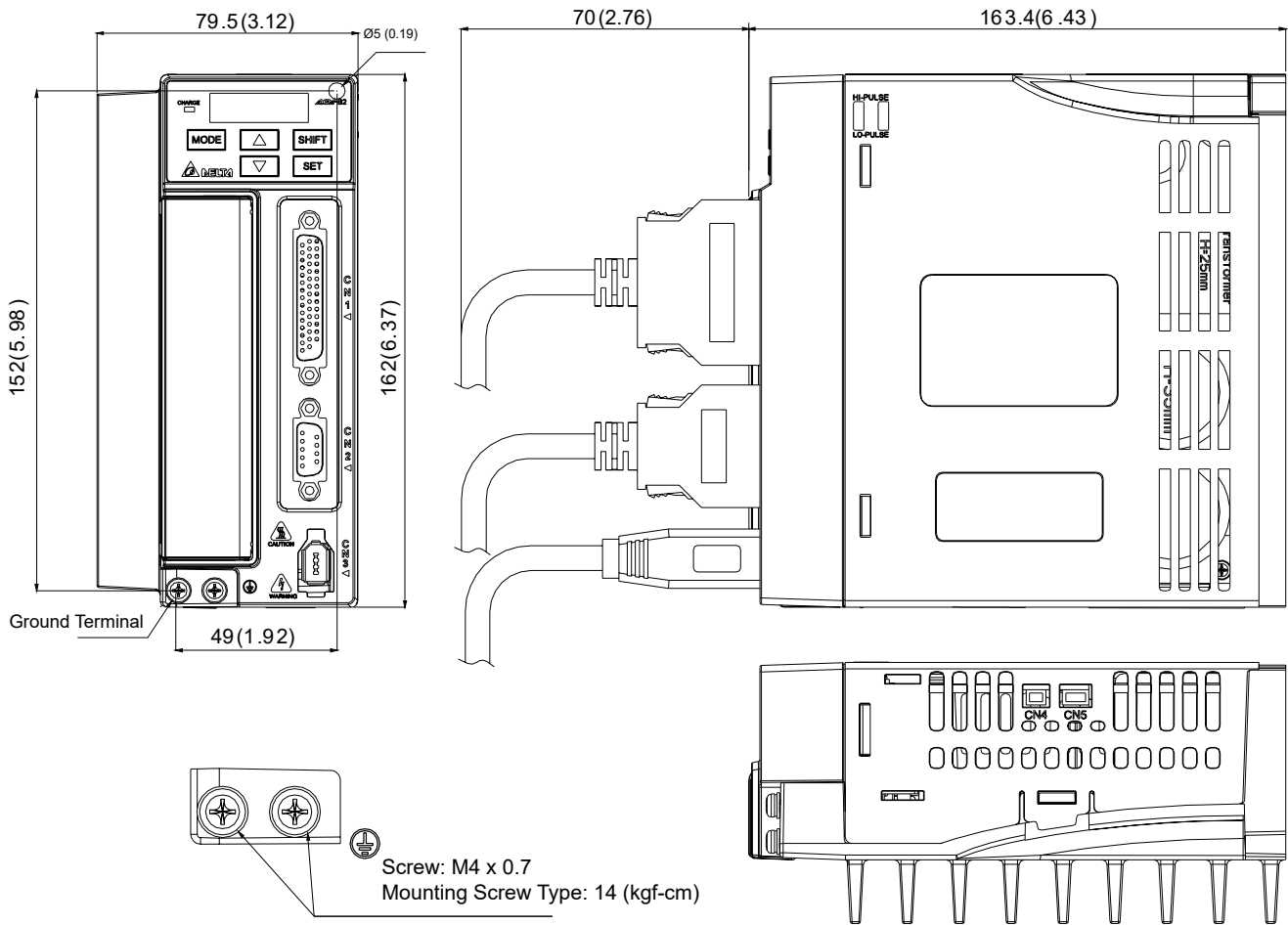

NOTE

- 1) Dimensions are in millimeters (inches); Weights are in kilograms (kg) and pounds (lbs).
- 2) Dimensions and weights of the servo drive may be updated without prior notice.

Dimensions

ASD-B2-1021

ASD-B2-1521

(1kW / 1.5kW)

Weight

1.72 (3.79)

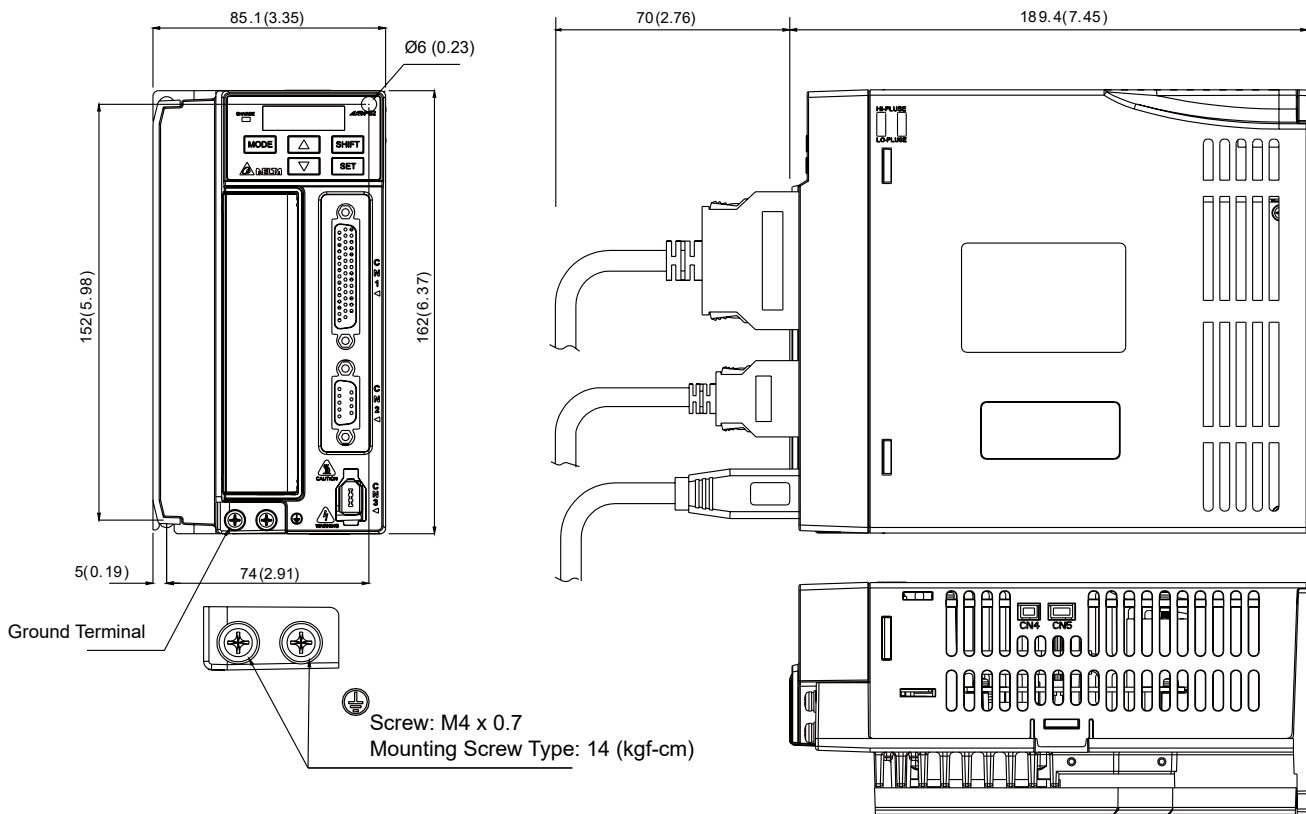

NOTE

- 1) Dimensions are in millimeters (inches); Weights are in kilograms (kg) and pounds (lbs).
- 2) Dimensions and weights of the servo drive may be updated without prior notice.

**ASD-B2-2023
ASD-B2-3023
(2kW / 3kW)**

Weight
2.67 (5.88)

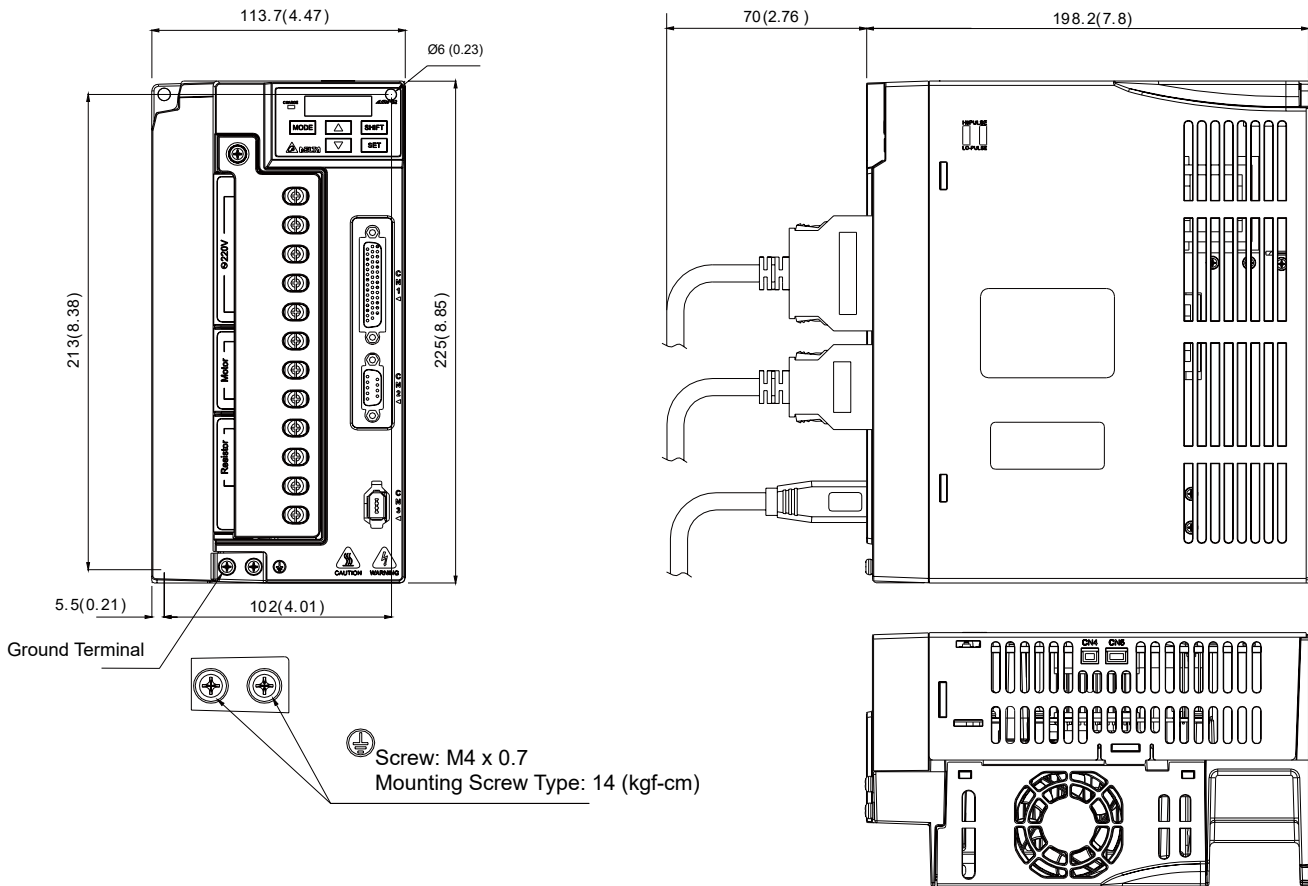

NOTE

- 1) Dimensions are in millimeters (inches); Weights are in kilograms (kg) and pounds (lbs).
- 2) Dimensions and weights of the servo drive may be updated without prior notice.

Servo Motor Specifications

Low Inertia Series

Model: ECMA Series	C△04			C△06			C△08		C△09		C△10		C△13
	01	02	04□S	04	07	07	10	10	20	30			
Rated power (kW)	0.1	0.2	0.4	0.4	0.75	0.75	1.0	1.0	2.0	3.0			
Rated torque (N-m) ¹	0.32	0.64	1.27	1.27	2.39	2.39	3.18	3.18	6.37	9.55			
Maximum torque (N-m)	0.96	1.92	3.82	3.82	7.16	7.14	8.78	9.54	19.11	28.65			
Rated speed (r/min)	3000			3000		3000		3000		3000			
Maximum speed (r/min)	5000			3000		5000		4500					
Rated current (A)	0.90	1.55	2.6	2.6	5.1	3.66	4.25	7.3	12.05	17.2			
Maximum current (A)	2.70	4.65	7.8	7.8	15.3	11	12.37	21.9	36.15	47.5			
Power rating (kW/s)	27.7	22.4	57.6	24.0	50.4	29.6	38.6	38.1	90.6	71.8			
Rotor inertia (x10 ⁻⁴ kg-m ²)(without brake)	0.037	0.177	0.277	0.68	1.13	1.93	2.62	2.65	4.45	12.7			
Mechanical constant (ms)	0.75	0.80	0.53	0.74	0.63	1.72	1.20	0.74	0.61	1.11			
Torque constant-KT (N-m/A)	0.36	0.41	0.49	0.49	0.47	0.65	0.75	0.44	0.53	0.557			
Voltage constant-KE(mV/(r/min))	13.6	16	17.4	18.5	17.2	24.2	27.5	16.8	19.2	20.98			
Armature resistance (Ohm)	9.30	2.79	1.55	0.93	0.42	1.34	0.897	0.20	0.13	0.0976			
Armature inductance (mH)	24.0	12.07	6.71	7.39	3.53	7.55	5.7	1.81	1.50	1.21			
Electric constant (ms)	2.58	4.3	4.3	7.96	8.36	5.66	6.35	9.3	11.4	12.4			
Insulation class	Class A (UL), Class B (CE)												
Insulation resistance	>100MΩ, 500V _{DC}												
Insulation strength	1.8kV _{AC} , 1sec												
Weight (kg) (without brake)	0.5	1.2	1.6	2.1	3.0	2.9	3.8	4.3	6.2	7.8			
Weight (kg) (with brake)	0.8	1.5	2.0	2.9	3.8	3.69	5.5	4.7	7.2	9.2			
Max. radial shaft load (N)	78.4	196	196	245	245	245	245	490	490	490			
Max. thrust shaft load (N)	39.2	68	68	98	98	98	98	98	98	98			
Power rating (kW/s) (with brake)	25.6	21.3	53.8	22.1	48.4	29.3	37.9	30.4	82	65.1			
Rotor inertia (x10 ⁻⁴ kg-m ²) (with brake)	0.04	0.192	0.30	0.73	1.18	1.95	2.67	3.33	4.95	14.0			
Mechanical constant (ms) (with brake)	0.81	0.85	0.57	0.78	0.65	1.74	1.22	0.93	0.66	1.22			
Brake holding torque [Nt·m (min)] ²	0.3	1.3	1.3	2.5	2.5	2.5	2.5	8	8	10.0			
Brake power consumption (at 20°C) [W]	7.3	6.5	6.5	8.2	8.2	8.2	8.2	18.7	18.7	19.0			
Brake release time [ms (Max)]	5	10	10	10	10	10	10	10	10	10			
Brake pull-in time [ms (Max)]	25	70	70	70	70	70	70	70	70	70			
Vibration grade (μm)	15												
Operating temperature (°C)	0°C to 40°C (32°F to 104°F)												
Storage temperature (°C)	-10°C to 80°C (-14°F to 176°F)												
Operating humidity	20 to 90% RH (non-condensing)												
Storage humidity	20 to 90% RH (non-condensing)												
Vibration capacity	2.5 G												
IP Rating	IP65 (when waterproof connectors are used, or when an oil seal is used to be fitted to the rotating shaft (an oil seal model is used))												
Certifications													

Footnote:

* 1 Rate torque values are continuous permissible values at 0-40°C ambient temperature when attaching with the sizes of heatsinks listed below:

ECMA-__04 / 06 / 08 : 250mm x 250mm x 6mm

ECMA-__10 : 300mm x 300mm x 12mm

ECMA-__13 : 400mm x 400mm x 20mm

ECMA-__18 : 550mm x 550mm x 30mm

ECMA-__22 : 650mm x 650mm x 30mm

Material type : Aluminum F40, F60, F80, F100, F130, F180, F220

*2 The holding brake is used to hold the motor shaft, not for braking the rotation. Never use it for decelerating or stopping the machine.

Servo Motor Specifications

Medium / High Inertia Series

Model: ECMA Series	E△13				E△18			G△13		
	05	10	15	20	20	30	35	03	06	09
Rated power (kW)	0.5	1.0	1.5	2.0	2.0	3.0	3.5	0.3	0.6	0.9
Rated torque (N-m) ^{*1}	2.39	4.77	7.16	9.55	9.55	14.32	16.71	2.86	5.73	8.59
Maximum torque (N-m)	7.16	14.3	21.48	28.65	28.65	42.97	50.13	8.59	17.19	21.48
Rated speed (r/min)	2000							1000		
Maximum speed (r/min)	3000							2000		
Rated current (A)	2.9	5.6	8.3	11.01	11.22	16.1	19.2	2.5	4.8	7.5
Maximum current (A)	8.7	16.8	24.9	33.03	33.66	48.3	57.6	7.5	14.4	22.5
Power rating (kW/s)	7.0	27.1	45.9	62.5	26.3	37.3	50.8	10.0	39.0	66.0
Rotor inertia (x10-4kg-m ²)(without brake)	8.17	8.41	11.18	14.59	34.68	54.95	54.95	8.17	8.41	11.18
Mechanical constant (ms)	1.91	1.51	1.10	0.96	1.62	1.06	1.08	1.84	1.40	1.06
Torque constant-KT (N-m/A)	0.83	0.85	0.87	0.87	0.85	0.89	0.87	1.15	1.19	1.15
Voltage constant-KE(mV/(r/min))	30.9	31.9	31.8	31.8	31.4	32.0	32	42.5	43.8	41.6
Armature resistance (Ohm)	0.57	0.47	0.26	0.174	0.119	0.052	0.052	1.06	0.82	0.43
Armature inductance (mH)	7.39	5.99	4.01	2.76	2.84	1.38	1.38	14.29	11.12	6.97
Electric constant (ms)	12.96	12.88	15.31	15.86	23.87	26.39	26.39	13.55	13.50	16.06
Insulation class	Class A (UL), Class B (CE)									
Insulation resistance	>100MΩ, 500V _{DC}									
Insulation strength	1.8kV _{AC} , 1sec									
Weight (kg) (without brake)	6.8	7.0	7.5	7.8	13.5	18.5	18.5	6.8	7.0	7.5
Weight (kg) (with brake)	8.2	8.4	8.9	9.2	17.5	22.5	22.5	8.2	8.4	8.9
Max. radial shaft load (N)	490	490	490	490	1176	1470	490	490	490	490
Max. thrust shaft load (N)	98	98	98	98	490	490	98	98	98	98
Power rating (kW/s) (with brake)	6.4	24.9	43.1	57.4	24.1	35.9	48.9	9.2	35.9	62.1
Rotor inertia (x10-4kg-m ²) (with brake)	8.94	9.14	11.90	15.88	37.86	57.06	57.06	8.94	9.14	11.9
Mechanical constant (ms) (with brake)	2.07	1.64	1.19	1.05	1.77	1.10	1.12	2.0	1.51	1.13
Brake holding torque [Nt-m (min)] ^{*2}	10.0	10.0	10.0	10.0	25.0	25.0	25.0	10.0	10.0	10.0
Brake power consumption (at 20°C) [W]	19.0	19.0	19.0	19.0	20.4	20.4	20.4	19.0	19.0	19.0
Brake release time [ms (Max)]	10	10	10	10	10	10	10	10	10	10
Brake pull-in time [ms (Max)]	70	70	70	70	70	70	70	70	70	70
Vibration grade (μm)	15									
Operating temperature (°C)	0°C to 40°C (32°F to 104°F)									
Storage temperature (°C)	-10°C to 80°C (-14°F to 176°F)									
Operating humidity	20 to 90% RH (non-condensing)									
Storage humidity	20 to 90% RH (non-condensing)									
Vibration capacity	2.5G									
IP Rating	IP65 (when waterproof connectors are used, or when an oil seal is used to be fitted to the rotating shaft (an oil seal model is used))									
Certifications										

Footnote:

* 1 Rate torque values are continuous permissible values at 0-40°C ambient temperature when attaching with the sizes of heatsinks listed below:

ECMA-__04 / 06 / 08 : 250mm × 250mm × 6mm

ECMA-__10 : 300mm × 300mm × 12mm

ECMA-__13 : 400mm × 400mm × 20mm

ECMA-__18 : 550mm × 550mm × 30mm

ECMA-__22 : 650mm × 650mm × 30mm

Material type : Aluminum F40, F60, F80, F100, F130, F180, F220

* 2 The holding brake is used to hold the motor shaft, not for braking the rotation. Never use it for decelerating or stopping the machine.

Servo Motor Specifications

Medium high / High Inertia Series

Model: ECMA Series	FΔ13			FΔ18
	08	13	18	30
Rated power (kW)	0.85	1.3	1.8	3.0
Rated torque (N-m) ¹	5.41	8.34	11.48	19.10
Maximum torque (N-m)	13.8	23.3	28.7	57.29
Rated speed (r/min)	1500			
Maximum speed (r/min)	3000			
Rated current (A)	7.1	12.6	13	19.4
Maximum current (A)	19.4	38.6	36	58.2
Power rating (kW/s)	21.52	34.78	52.93	66.4
Rotor inertia (x10 ⁻⁴ kg-m ²)(without brake)	13.6	20	24.9	54.95
Mechanical constant (ms)	2.43	1.62	1.7	1.28
Torque constant-KT (N-m/A)	0.76	0.66	0.88	0.98
Voltage constant-KE(mV/(r/min))	29.2	24.2	32.2	35.0
Armature resistance (Ohm)	0.38	0.124	0.185	0.077
Armature inductance (mH)	4.77	1.7	2.6	1.27
Electric constant (ms)	12.55	13.71	14.05	16.5
Insulation class	Class A (UL), Class B (CE)			
Insulation resistance	>100MΩ, 500 V _{DC}			
Insulation strength	1.8kV _{AC} , 1 sec			
Weight (kg) (without brake)	8.6	9.4	10.5	18.5
Weight (kg) (with brake)	10.0	10.8	11.9	22.5
Max. radial shaft load (N)	490	490	490	1470
Max. thrust shaft load (N)	98	98	98	490
Power rating (kW/s) (with brake)	19.78	32.66	50.3	63.9
Rotor inertia (x10 ⁻⁴ kg-m ²) (with brake)	14.8	21.3	26.2	57.06
Mechanical constant (ms) (with brake)	2.65	1.73	1.79	1.33
Brake holding torque [Nt-m (min)] ²	10.0	10.0	10.0	25.0
Brake power consumption (at 20°C) [W]	19.0	19.0	19.0	20.4
Brake release time [ms (Max)]	10	10	10	10
Brake pull-in time [ms (Max)]	70	70	70	70
Vibration grade (μm)	15			
Operating temperature (°C)	0°C~ 40°C			
Storage temperature (°C)	-10°C to 80°C (-14°F to 176°F)			
Operating humidity	20 to 90% RH (non-condensing)			
Storage humidity	20 to 90% RH (non-condensing)			
Vibration capacity	2.5G			
IP Rating	IP65 (when waterproof connectors are used, or when an oil seal is used to be fitted to the rotating shaft (an oil seal model is used))			
Certifications				

Footnote:

*1 Rate torque values are continuous permissible values at 0 ~ 40° C ambient temperature when attaching with the sizes of heatsinks listed below:

ECMA-__04 / 06 / 08 : 250mm x 250mm x 6mm

ECMA-__10 : 300mm x 300mm x 12mm

ECMA-__13 : 400mm x 400mm x 20mm

ECMA-__18 : 550mm x 550mm x 30mm

ECMA-__22 : 650mm x 650mm x 35mm

Material type : Aluminum – F40, F60, F80, F100, F130, F180

*2 The holding brake is used to hold the motor shaft, not for braking the rotation. Never use it for decelerating or stopping the machine.

Servo Motor Specifications

High Inertia Series

Model: ECMA Series	CΔ06	CΔ08
	04 □ H	07 □ H
Rated power (kW)	0.4	0.75
Rated torque (N-m) ¹	1.27	2.39
Maximum torque (N-m)	3.82	7.16
Rated speed (r/min)	3000	
Maximum speed (r/min)	5000	
Rated current (A)	2.6	5.1
Maximum current (A)	7.8	15.3
Power rating (kW/s)	21.7	19.63
Rotor inertia (x10 ⁻⁴ kg-m ²)(without brake)	0.743	2.91
Mechanical constant (ms)	1.42	1.6
Torque constant-KT (N-m/A)	0.49	0.47
Voltage constant-KE(mV/(r/min))	17.4	17.2
Armature resistance (Ohm)	1.55	0.42
Armature inductance (mH)	6.71	3.53
Electric constant (ms)	4.3	8.36
Insulation class	Class A (UL), Class B (CE)	
Insulation resistance	>100MΩ, 500V _{DC}	
Insulation strength	1.8kV _{AC} , 1 sec	
Weight (kg) (without brake)	1.8	3.4
Weight (kg) (with brake)	2.2	3.9
Max. radial shaft load (N)	196	245
Max. thrust shaft load (N)	68	98
Power rating (kW/s) (with brake)	21.48	19.3
Rotor inertia (x10 ⁻⁴ kg-m ²) (with brake)	0.751	2.96
Mechanical constant (ms) (with brake)	1.43	1.62
Brake holding torque [Nt-m (min)] ²	1.3	2.5
Brake power consumption (at 20 °C) [W]	6.5	8.2
Brake release time [ms (Max)]	10	10
Brake pull-in time [ms (Max)]	70	70
Vibration grade (μm)	15	
Operating temperature (°C)	0°C~ 40°C	
Storage temperature (°C)	-10°C to 80°C (-14°F to 176°F)	
Operating humidity	20 to 90% RH (non-condensing)	
Storage humidity	20 to 90% RH (non-condensing)	
Vibration capacity	2.5G	
IP Rating	IP65 (when waterproof connectors are used, or when an oil seal is used to be fitted to the rotating shaft (an oil seal model is used))	
Certifications		

Footnote:

*1 Rate torque values are continuous permissible values at 0 ~ 40° C ambient temperature when attaching with the sizes of heatsinks listed below:

- ECMA- 04 / 06 / 08 : 250mm x 250mm x 6mm
- ECMA- 10 : 300mm x 300mm x 12mm
- ECMA- 13 : 400mm x 400mm x 20mm
- ECMA- 18 : 550mm x 550mm x 30mm
- ECMA- 22 : 650mm x 650mm x 35mm

Material type : Aluminum – F40, F60, F80, F100, F130, F180

*2 The holding brake is used to hold the motor shaft, not for braking the rotation. Never use it for decelerating or stopping the machine.

Servo Motor Dimensions

Motors - Frame Size 86mm and below

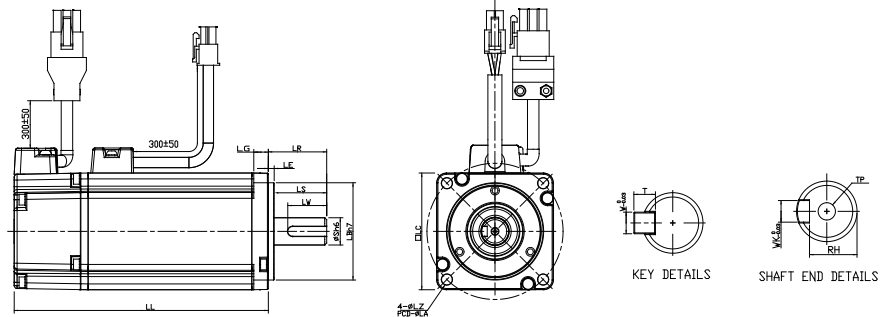

Units: mm

Model	C Δ 0401 \square S	C Δ 0602 \square S	C Δ 0604 \square S	C Δ 0604 \square H	C Δ 0804 \square 7	C Δ 0807 \square S	C Δ 0807 \square H	C Δ 0907 \square S	C Δ 0910 \square S
LC	40	60	60	60	80	80	80	86	86
LZ	4.5	5.5	5.5	5.5	6.6	6.6	6.6	6.6	6.6
LA	46	70	70	70	90	90	90	100	100
S	8 (+0/-0.009)	14 (+0/-0.011)	14 (+0/-0.011)	14 (+0/-0.011)	14 (+0/-0.011)	19 (+0/-0.013)	19 (+0/-0.013)	16 (+0/-0.011)	16 (+0/-0.011)
LB	30 (+0/-0.021)	50 (+0/-0.025)	50 (+0/-0.025)	50 (+0/-0.025)	70 (+0/-0.030)	70 (+0/-0.030)	70 (+0/-0.030)	80 (+0/-0.030)	80 (+0/-0.030)
LL (without brake)	100.6	105.5	130.7	145.8	112.3	138.3	154.8	130.2	153.2
LL (with brake)	136.8	141.6	166.8	176.37	152.8	178	187.8	161.3	184.3
LS	20	27	27	27	27	32	32	30	30
LR	25	30	30	30	30	35	35	35	35
LE	2.5	3	3	3	3	3	3	3	3
LG	5	7.5	7.5	7.5	8	8	8	8	8
LW	16	20	20	20	20	25	25	20	20
RH	6.2	11	11	11	11	15.5	15.5	13	13
WK	3	5	5	5	5	6	6	5	5
W	3	5	5	5	5	6	6	5	5
T	3	5	5	5	5	6	6	5	5
TP	M3 Depth 8	M4 Depth 15	M4 Depth 15	M4 Depth 15	M4 Depth 15	M6 Depth 20	M6 Depth 20	M5 Depth 15	M5 Depth 15



- 1) Dimensions are in millimeters. Actual measured values are in metric units.
- 2) Dimensions of the servo motor may be updated without prior notice.
- 3) The boxes (\square) in the model names represent shaft end/brake or the number of oil seal.
- 4) The boxes (Δ) in the model names represent encoder types (Δ =1: Incremental encoder, 20-bit; Δ =2: Incremental encoder, 17-bit).

Speed-Torque Curves (T-N Curves)

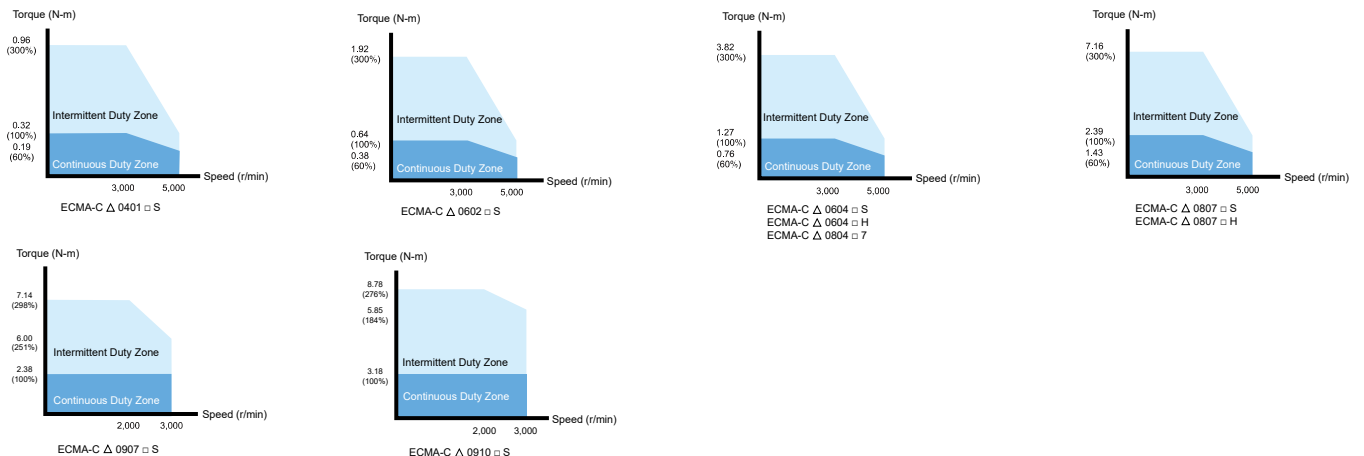

Motors - Frame Size 100mm ~ 130mm

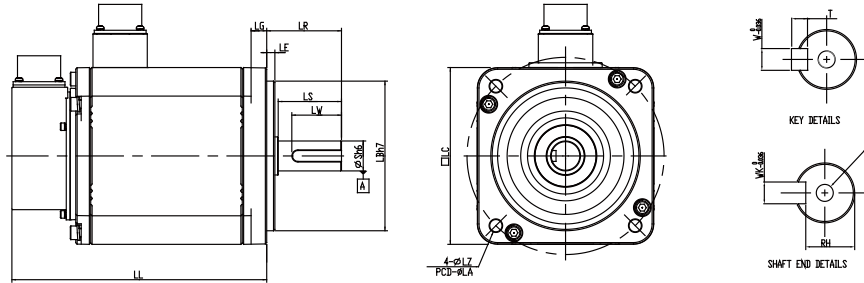

Units: mm

Model	C Δ 1010 \square S	C Δ 1020 \square S	C Δ 1330 \square 4	E Δ 1305 \square S	E Δ 1310 \square S	E Δ 1315 \square S
LC	100	100	130	130	130	130
LZ	9	9	9	9	9	9
LA	115	115	145	145	145	145
S	22 ($^{+0}_{-0.013}$)	22 ($^{+0}_{-0.013}$)	24 ($^{+0}_{-0.013}$)	22 ($^{+0}_{-0.013}$)	22 ($^{+0}_{-0.013}$)	22 ($^{+0}_{-0.013}$)
LB	95 ($^{+0}_{-0.035}$)	95 ($^{+0}_{-0.035}$)	110 ($^{+0}_{-0.035}$)	110 ($^{+0}_{-0.035}$)	110 ($^{+0}_{-0.035}$)	110 ($^{+0}_{-0.035}$)
LL (不帶煞車)	153.3	199	187.5	147.5	147.5	167.5
LL (帶煞車)	192.5	226	216	183.5	183.5	202
LS	37	37	47	47	47	47
LR	45	45	55	55	55	55
LE	5	5	6	6	6	6
LG	12	12	11.5	11.5	11.5	11.5
LW	32	32	36	36	36	36
RH	18	18	20	18	18	18
WK	8	8	8	8	8	8
W	8	8	8	8	8	8
T	7	7	7	7	7	7
TP	M6 Depth 20	M6 Depth 20	M6 Depth 20	M6 Depth 20	M6 Depth 20	M6 Depth 20



- 1) Dimensions are in millimeters. Actual measured values are in metric units.
- 2) Dimensions of the servo motor may be updated without prior notice.
- 3) The boxes (\square) in the model names represent shaft end/brake or the number of oil seal.
- 4) The boxes (Δ) in the model names represent encoder types ($\Delta=1$: Incremental encoder, 20-bit; $\Delta=2$: Incremental encoder, 17-bit).

Speed-Torque Curves (T-N Curves)

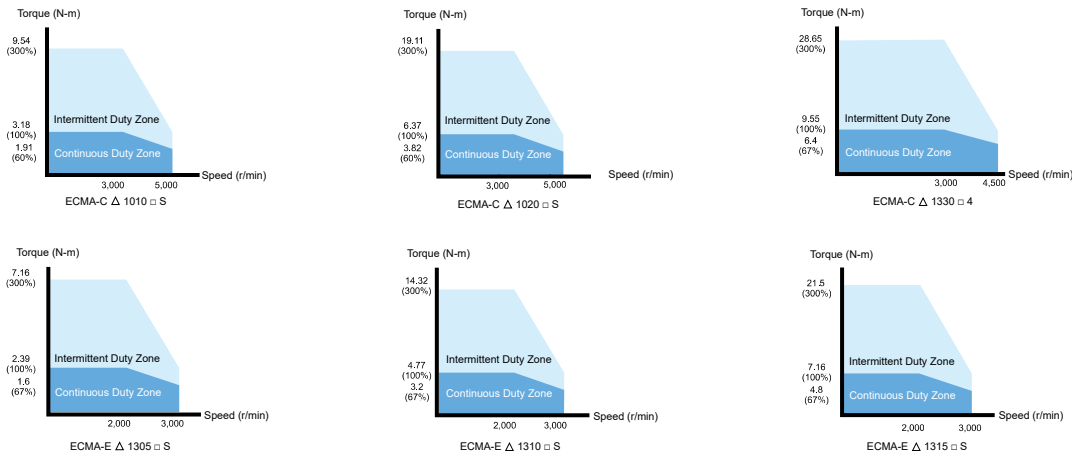

Servo Motor Dimensions

Motors - Frame Size 100mm ~ 130mm

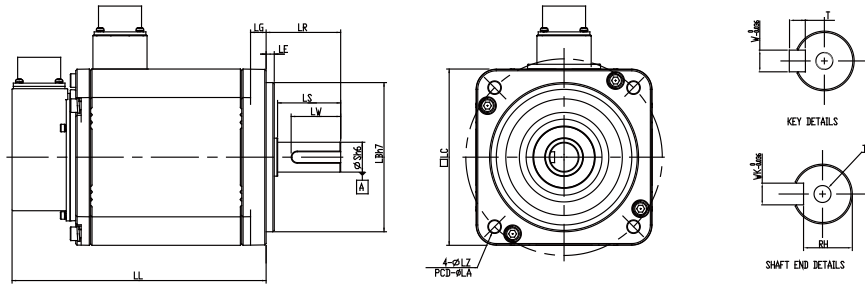

Units: mm

Model	E Δ 1320 \square S	F Δ 1308 \square S	F Δ 1313 \square S	F Δ 1318 \square S	G Δ 1303 \square S	G Δ 1306 \square S	G Δ 1309 \square S
LC	130	130	130	130	130	130	130
LZ	9	9	9	9	9	9	9
LA	145	145	145	145	145	145	145
S	22 (+0 / -0.013)	22 (+0 / -0.013)	22 (+0 / -0.013)	22 (+0 / -0.013)	22 (+0 / -0.013)	22 (+0 / -0.013)	22 (+0 / -0.013)
LB	110 (+0 / -0.035)	110 (+0 / -0.035)	110 (+0 / -0.035)	110 (+0 / -0.035)	110 (+0 / -0.035)	110 (+0 / -0.035)	110 (+0 / -0.035)
LL (without brake)	187.5	152.5	187.5	202	147.5	147.5	163.5
LL (with brake)	216	181	216	230.7	183.5	183.5	198
LS	47	47	47	47	47	47	47
LR	55	55	55	55	55	55	55
LE	6	6	6	6	6	6	6
LG	11.5	11.5	11.5	11.5	11.5	11.5	11.5
LW	36	36	36	36	36	36	36
RH	18	18	18	18	18	18	18
WK	8	8	8	8	8	8	8
W	8	8	8	8	8	8	8
T	7	7	7	7	7	7	7
TP	M6 Depth 20	M6 Depth 20	M6 Depth 20	M6 Depth 20	M6 Depth 20	M6 Depth 20	M6 Depth 20



- 1) Dimensions are in millimeters. Actual measured values are in metric units.
- 2) Dimensions of the servo motor may be updated without prior notice.
- 3) The boxes (\square) in the model names represent shaft end/brake or the number of oil seal.
- 4) The boxes (Δ) in the model names represent encoder types (Δ =1: Incremental encoder, 20-bit; Δ =2: Incremental encoder, 17-bit).

Speed-Torque Curves (T-N Curves)

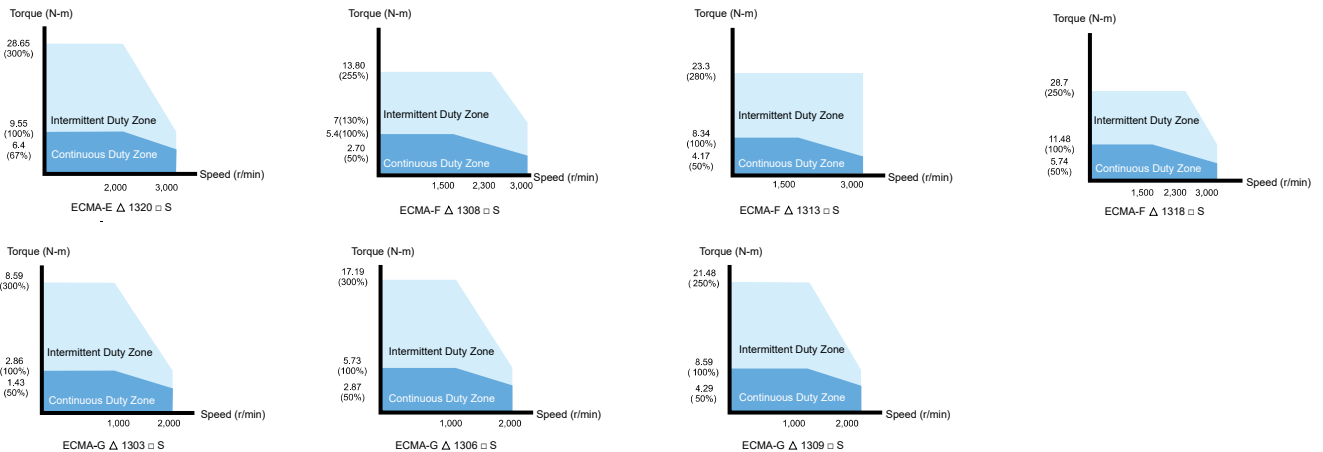

Motors - Frame Size 180mm

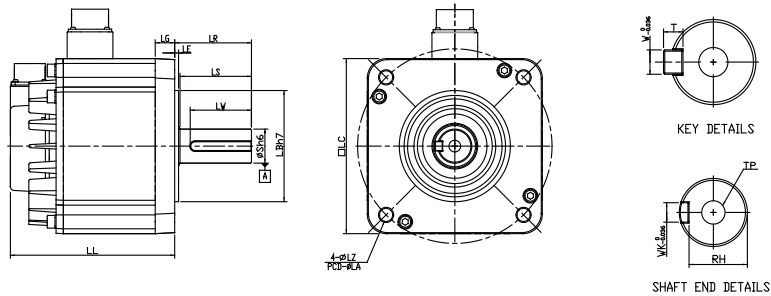

Units: mm

Model	E Δ 1820 □ S	E Δ 1830 □ S	F Δ 1830 □ S	E Δ 1835 □ S
LC	180	180	180	180
LZ	13.5	13.5	13.5	13.5
LA	200	200	200	200
S	35 (+0 / -0.016)	35 (+0 / -0.016)	35 (+0 / -0.016)	35 (+0 / -0.016)
LB	114.3 (+0 / -0.035)	114.3 (+0 / -0.035)	114.3 (+0 / -0.035)	114.3 (+0 / -0.035)
LL (without brake)	169	202.1	202.1	202.1
LL (with brake)	203.1	235.3	235.3	235.3
LS	73	73	73	73
LR	79	79	79	79
LE	4	4	4	4
LG	20	20	20	20
LW	63	63	63	63
RH	30	30	30	30
WK	10	10	10	10
W	10	10	10	10
T	8	8	8	8
TP	M12 Depth 25	M12 Depth 25	M12 Depth 25	M12 Depth 25



NOTE

- 1) Dimensions are in millimeters. Actual measured values are in metric units.
- 2) Dimensions of the servo motor may be updated without prior notice.
- 3) The boxes (□) in the model names represent shaft end/brake or the number of oil seal.
- 4) The boxes (Δ) in the model names represent encoder types (Δ=1: Incremental encoder, 20-bit; Δ=2: Incremental encoder, 17-bit).

Speed-Torque Curves (T-N Curves)

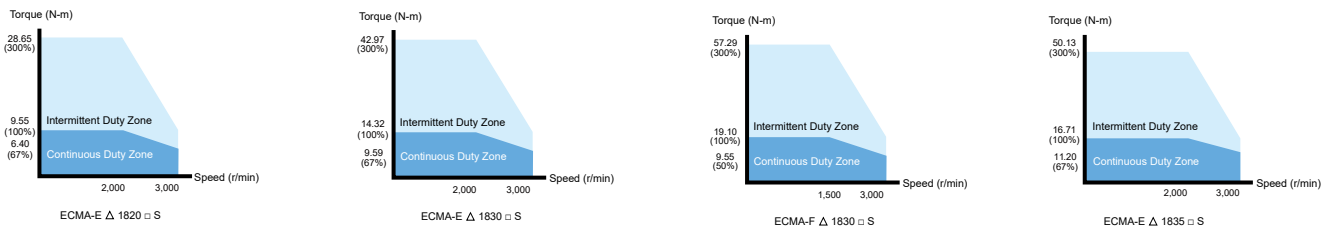

Optional Accessories

Power Cables

- 3m and 5m standard cables are available.
- Individual connectors are also provided for different demands.
- Two types are selectable: with brake and without brake.

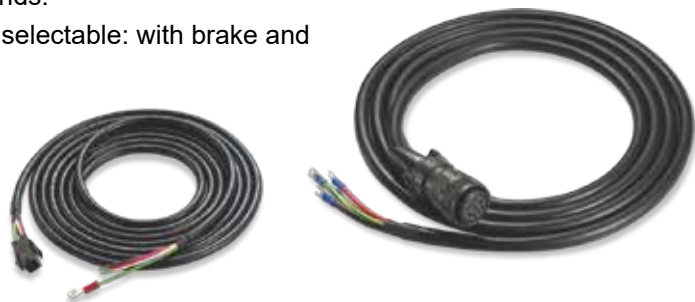

CN1 I/O Connectors

- Used to connect to external (host) controller
- Delta Part Number: ASDBCNDS0044



CN1 Convenient Connector

- Delta Part Number: ASD-IF-DS4444



Encoder Cables

- 3m and 5m standard cables are available.
- Individual connectors are also provided for different demands.





Regenerative Resistors

- Two kinds of regenerative resistors are available, 400W / 40Ω and 1kW / 20Ω.



Terminal Block Modules

- 0.5m connection cable is provided for saving on installation space.
- Delta Part Number: ASD-MDDS4444



RS-485 Connectors

- Used to connect multiple ASDA Series products by RS-485 interface through Modbus serial communication.
- Delta Part Number: ASD-CNIE0B06



ASD-Soft Software Communication Cables (for PC)

- Delta Part Number: ASD-CNUS0A08



The figures are for illustration purposes only. Actual models may differ slightly in appearance from illustrations provided.

Optional Accessories

Power Connectors

ASDBCAPW0000



ASD-CAPW1000

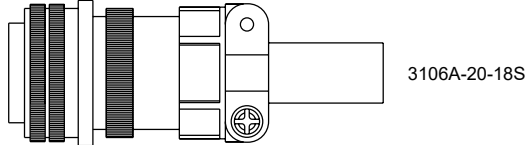

3106A-20-18S

ASDBCAPW0100

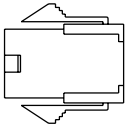

ASD-CAPW2000

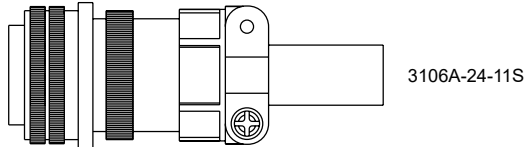

3106A-24-11S

Power Cables

ASDBCAPW0203/0205

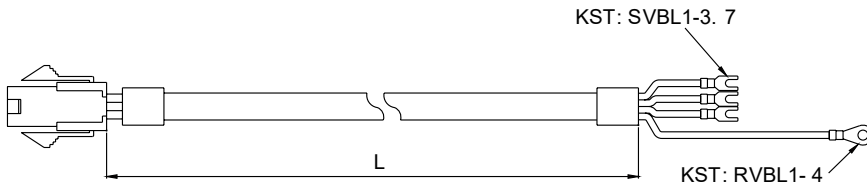

Item	Part No.	L	
		mm	inch
1	ASDBCAPW0203	3000 ± 50	118 ± 2
2	ASDBCAPW0205	5000 ± 50	197 ± 2

ASDBCAPW0303/0305

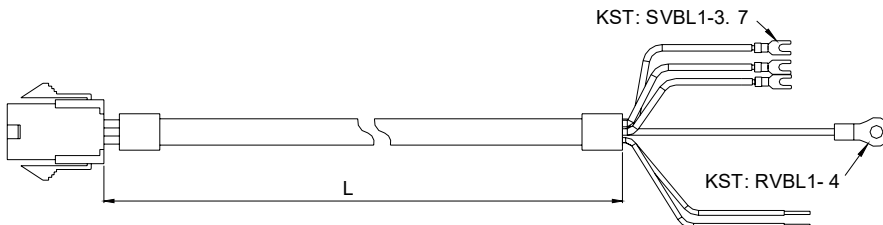

Item	Part No.	L	
		mm	inch
1	ASDBCAPW0303	3000 ± 50	118 ± 2
2	ASDBCAPW0305	5000 ± 50	197 ± 2

Power Cables

ASDBCAPW1203/1205

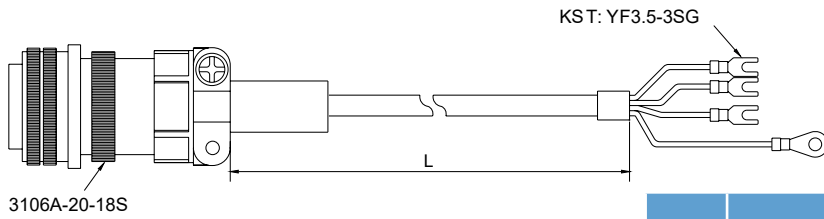

Item	Part No.	Straight	L	
			mm	inch
1	ASDBCAPW1203	3106A-20-18S	3000 ± 50	118 ± 2
2	ASDBCAPW1205	3106A-20-18S	5000 ± 50	197 ± 2

ASDBCAPW1303/1305

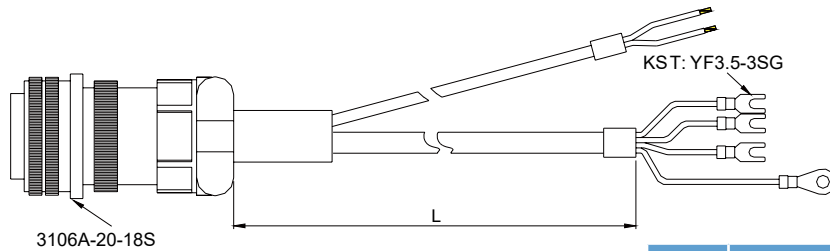

Item	Part No.	Straight	L	
			mm	inch
1	ASDBCAPW1303	3106A-20-18S	3000 ± 50	118 ± 2
2	ASDBCAPW1305	3106A-20-18S	5000 ± 50	197 ± 2

ASD-CAPW2203/2205

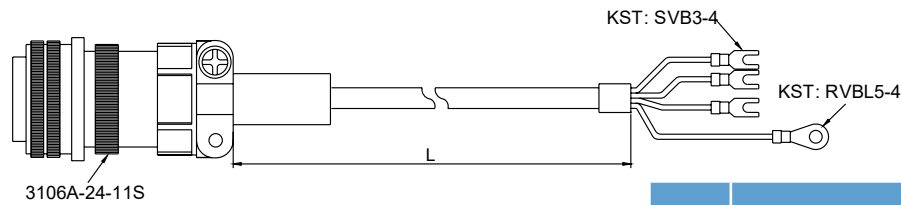

Item	Part No.	Straight	L	
			mm	inch
1	ASD-CAPW2203	3106A-24-11S	3000 ± 50	118 ± 2
2	ASD-CAPW2205	3106A-24-11S	5000 ± 50	197 ± 2

ASD-CAPW2303/2305

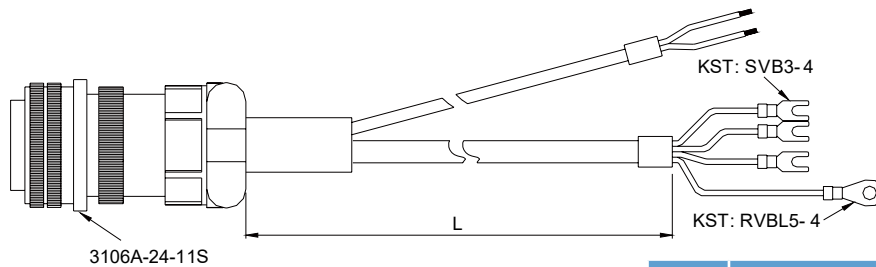

Item	Part No.	Straight	L	
			mm	inch
1	ASD-CAPW2303	3106A-24-11S	3000 ± 50	118 ± 2
2	ASD-CAPW2305	3106A-24-11S	5000 ± 50	197 ± 2

Optional Accessories

Encoder Connectors

ASDBCAEN0000

D-SUB Connector 9P

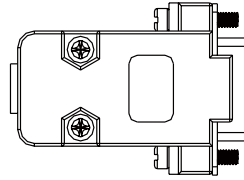

ASDBCAEN1000

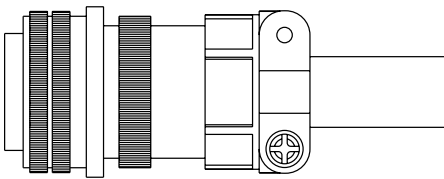

3106A-20-29S

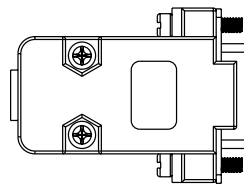

D-SUB Connector 9P

Encoder Cables

ASDBCAEN0003/0005

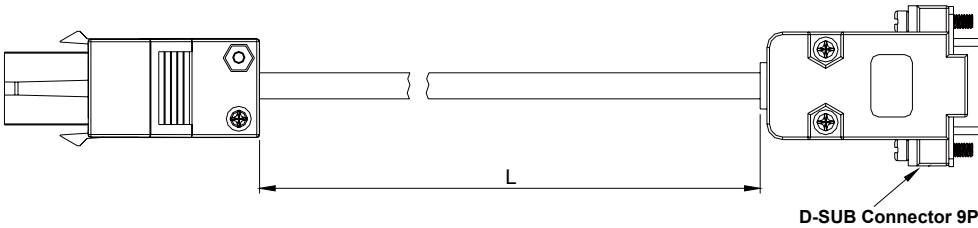

D-SUB Connector 9P

Item	Part No.	L	
		mm	inch
1	ASDBCAEN0003	3000 ± 50	118 ± 2
2	ASDBCAEN0005	5000 ± 50	197 ± 2

ASDBCAEN1003/1005

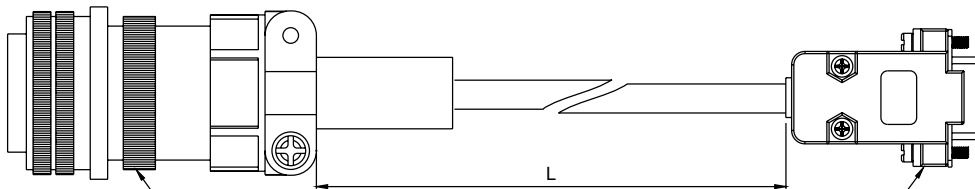

3106A-20-29S

D-SUB Connector 9P

Item	Part No.	Straight	L	
			mm	inch
1	ASDBCAEN1003	3106A-20-29S	3000 ± 50	118 ± 2
2	ASDBCAEN1005	3106A-20-29S	5000 ± 50	197 ± 2

I/O Signal Connector

ASD-BCNDS0044
D-SUB 44 PIN PLUG

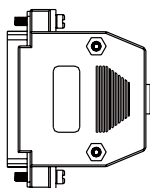

ASDBCAEN1000
D-SUB 15 PIN PLUG

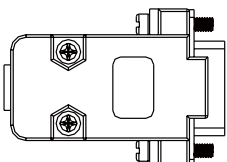

RS-485 Connector Dimensions are in mm

ASD-CNIE0B06

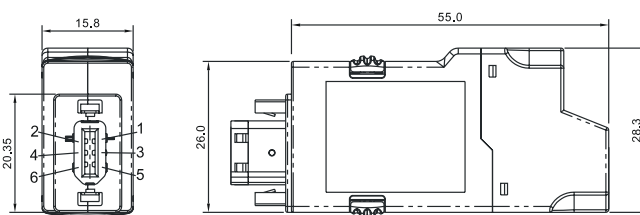

- NOTE**
- 1) More accessories for ASDA-B2 will be on the list.
 - 2) Accessories images shown here may differ from the actual product.

Communication Cable between Drive and Computer (for PC) Dimensions are in mm

ASD-CNUS0A08

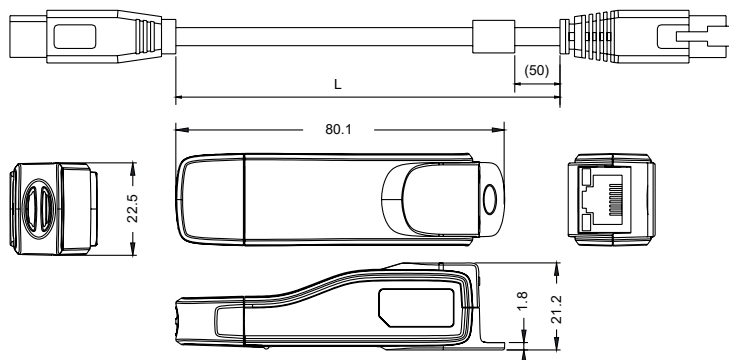

Title	Part No. Part No. : ASD-CNUS0A08	
Cable	L	3000 ± 100 mm
		118 ± 4 inch
Connector	RJ connector	RJ-45
	USB connector	A-type (USB V2.0)

Voltage Output Cable (Analog Signal) Dimensions are in mm

3864471800

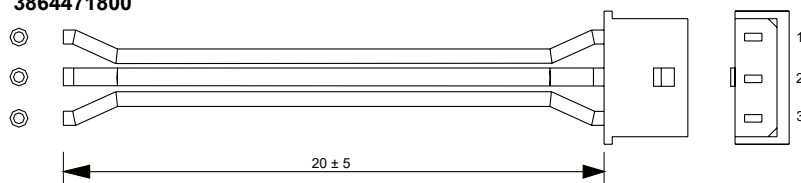

Terminal Block Module Dimensions are in mm

ASD-MDDS4444

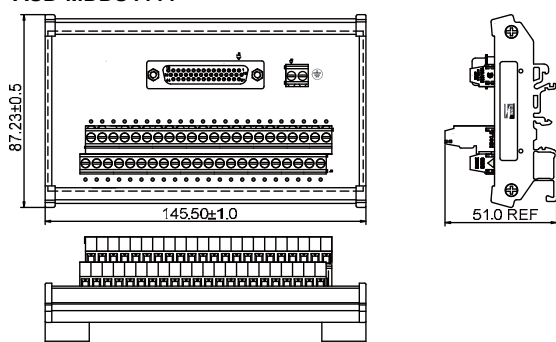

Accessories Combinations

100W Servo Drive and 100W Low Inertia Servo Motor

Servo Drive	ASD-B2-0121-B
Low Inertia Servo Motor	ECMA-C △ 0401 □ S
Power Cables (Without Brake)	ASDBCAPW020X
Power Connectors (Without Brake)	ASDBCAPW0000
Power Cables (With Brake)	ASDBCAPW030X
Power Connectors (With Brake)	ASDBCAPW0100
Encoder Cables	ASDBCAEN000X
Encoder Connectors	ASDBCAEN0000

(X=3 indicates that the cable length is 3m; X=5 indicates that the cable length is 5m)

200W Servo Drive and 200W Low Inertia Servo Motor

Servo Drive	ASD-B2-0221-B
Low Inertia Servo Motor	ECMA-C △ 0602 □ S
Power Cables (Without Brake)	ASDBCAPW020X
Power Connectors (Without Brake)	ASDBCAPW0000
Power Cables (With Brake)	ASDBCAPW030X
Power Connectors (With Brake)	ASDBCAPW0100
Encoder Cables	ASDBCAEN000X
Encoder Connectors	ASDBCAEN0000

(X=3 indicates that the cable length is 3m; X=5 indicates that the cable length is 5m)

400W Servo Drive and 400W Low Inertia Servo Motor

Servo Drive	ASD-B2-0421-B
Low Inertia Servo Motor	ECMA-C △ 0604 □ S ECMA-C △ 0804 □ 7 ECMA-CM0604PS
Power Cables (Without Brake)	ASDBCAPW020X
Power Connectors (Without Brake)	ASDBCAPW0000
Power Cables (With Brake)	ASDBCAPW030X
Power Connectors (With Brake)	ASDBCAPW0100
Encoder Cables	ASDBCAEN000X
Encoder Connectors	ASDBCAEN0000

(X=3 indicates that the cable length is 3m; X=5 indicates that the cable length is 5m)

400W Servo Drive and 400W High Inertia Servo Motor

Servo Drive	ASD-B2-0421-B
High Inertia Servo Motor	ECMA-C △ 0604 □ H
Power Cables (Without Brake)	ASDBCAPW020X
Power Connectors (Without Brake)	ASDBCAPW0000
Power Cables (With Brake)	ASDBCAPW030X
Power Connectors (With Brake)	ASDBCAPW0100
Encoder Cables	ASDBCAEN000X
Encoder Connectors	ASDBCAEN0000

(X=3 indicates that the cable length is 3m; X=5 indicates that the cable length is 5m)

400W Servo Drive and 500W Medium Inertia Servo Motor

Servo Drive	ASD-B2-0421-B
Medium Inertia Servo Motor	ECMA-E △ 1305 □ S
Power Cables (Without Brake)	ASDBCAPW120X
Power Cables (With Brake)	ASDBCAPW130X
Power Connectors	ASD-CAPW1000
Incremental Encoder Cables	ASDBCAEN100X
Encoder Connectors	ASDBCAEN1000

(X=3 indicates that the cable length is 3m; X=5 indicates that the cable length is 5m)

400W Servo Drive and 300W High Inertia Servo Motor

Servo Drive	ASD-B2-0421-B
High Inertia Servo Motor	ECMA-G △ 1303 □ S
Power Cables (Without Brake)	ASDBCAPW120X
Power Cables (With Brake)	ASDBCAPW130X
Power Connectors	ASD-CAPW1000
Encoder Cables	ASDBCAEN100X
Encoder Connectors	ASDBCAEN1000

(X=3 indicates that the cable length is 3m; X=5 indicates that the cable length is 5m)

750W Servo Drive and 600W High Inertia Servo Motor

Servo Drive	ASD-B2-0721-B
High Inertia Servo Motor	ECMA-G △ 1306 □ S ECMA-GM1306PS
Power Cables (Without Brake)	ASDBCAPW120X
Power Cables (With Brake)	ASDBCAPW130X
Power Connectors	ASD-CAPW1000
Encoder Cables	ASDBCAEN100X
Encoder Connectors	ASDBCAEN1000

(X=3 indicates that the cable length is 3m; X=5 indicates that the cable length is 5m)

750W Servo Drive and 750W Low Inertia Servo Motor

Servo Drive	ASD-B2-0721-B
Low Inertia Servo Motor	ECMA-C △ 0807 □ S ECMA-C △ 0907 □ 7 ECMA-CM0807PS
Power Cables (Without Brake)	ASDBCAPW020X
Power Connectors (Without Brake)	ASDBCAPW0000
Power Cables (With Brake)	ASDBCAPW030X
Power Connectors (With Brake)	ASDBCAPW0100
Encoder Cables	ASDBCAEN000X
Encoder Connectors	ASDBCAEN0000

(X=3 indicates that the cable length is 3m; X=5 indicates that the cable length is 5m)

Accessories Combinations

750W Servo Drive and 750W High Inertia Servo Motor

Servo Drive	ASD-B2-0721-B
High Inertia Servo Motor	ECMA-C △ 0807□H
Power Cables (Without Brake)	ASDBCAPW020X
Power Connectors (Without Brake)	ASDBCAPW0000
Power Cables (With Brake)	ASDBCAPW030X
Power Connectors (With Brake)	ASDBCAPW0100
Encoder Cables	ASDBCAEN000X
Encoder Connectors	ASDBCAEN0000

(X=3 indicates that the cable length is 3m; X=5 indicates that the cable length is 5m)

1kW Servo Drive and 850W Low Inertia Servo Motor

Servo Drive	ASD-B2-1021-B
Low Inertia Servo Motor	ECMA-F △ 1308 □ S
Power Cables (Without Brake)	ASDBCAPW120X
Power Cables (With Brake)	ASDBCAPW130X
Power Connectors	ASD-CAPW1000
Encoder Cables	ASDBCAEN100X
Encoder Connectors	ASDBCAEN1000

(X=3 indicates that the cable length is 3m; X=5 indicates that the cable length is 5m)

1kW Servo Drive and 1kW Low Inertia Servo Motor

Servo Drive	ASD-B2-1021-B
Low Inertia Servo Motor	ECMA-C △ 1010 □ S
Power Cables (Without Brake)	ASDBCAPW120X
Power Cables (With Brake)	ASDBCAPW130X
Power Connectors	ASD-CAPW1000
Encoder Cables	ASDBCAEN100X
Encoder Connectors	ASDBCAEN1000

(X=3 indicates that the cable length is 3m; X=5 indicates that the cable length is 5m)

1kW Servo Drive and 1kW Low Inertia Servo Motor

Servo Drive	ASD-B2-1021-B
Low Inertia Servo Motor	ECMA-C △ 0910 □ S
Power Cables (Without Brake)	ASDBCAPW020X
Power Connectors (Without Brake)	ASDBCAPW0000
Power Cables (With Brake)	ASDBCAPW030X
Power Connectors (With Brake)	ASDBCAPW0100
Incremental Encoder Cables	ASDBCAEN000X
Encoder Connectors	ASDBCAEN0000

(X=3 indicates that the cable length is 3m; X=5 indicates that the cable length is 5m)

1kW Servo Drive and 1kW Medium Inertia Servo Motor

Servo Drive	ASD-B2-1021-B
Medium Inertia Servo Motor	ECMA-E \triangle 1310 \square S
Power Cables (Without Brake)	ASDBCAPW120X
Power Cables (With Brake)	ASDBCAPW130X
Power Connectors	ASD-CAPW1000
Encoder Cables	ASDBCAEN100X
Encoder Connectors	ASDBCAEN1000

(X=3 indicates that the cable length is 3m; X=5 indicates that the cable length is 5m)

1kW Servo Drive and 900W High Inertia Servo Motor

Servo Drive	ASD-B2-1021-B
High Inertia Servo Motor	ECMA-G \triangle 1309 \square S ECMA-GM1309PS
Power Cables (Without Brake)	ASDBCAPW120X
Power Cables (With Brake)	ASDBCAPW130X
Power Connectors	ASD-CAPW1000
Encoder Cables	ASDBCAEN100X
Encoder Connectors	ASDBCAEN1000

(X=3 indicates that the cable length is 3m; X=5 indicates that the cable length is 5m)

1.5kW Servo Drive and 1.5kW Medium Inertia Servo Motor

Servo Drive	ASD-B2-1521-B
Medium Inertia Servo Motor	ECMA-E \triangle 1315 \square S
Power Cables (Without Brake)	ASDBCAPW120X
Power Cables (With Brake)	ASDBCAPW130X
Power Connectors	ASD-CAPW1000
Encoder Cables	ASDBCAEN100X
Encoder Connectors	ASDBCAEN1000

(X=3 indicates that the cable length is 3m; X=5 indicates that the cable length is 5m)

2kW Servo Drive and 2kW Low Inertia Servo Motor

Servo Drive	ASD-B2-2023-B
Low Inertia Servo Motor	ECMA-C \triangle 1020 \square S
Power Cables (Without Brake)	ASDBCAPW120X
Power Cables (With Brake)	ASDBCAPW130X
Power Connectors	ASDBCAPW1000
Encoder Cables	ASDBCAEN100X
Encoder Connectors	ASDBCAEN1000

(X=3 indicates that the cable length is 3m; X=5 indicates that the cable length is 5m)

Accessories Combinations

2kW Servo Drive and 2kW Medium Inertia Servo Motor

Servo Drive	ASD-B2-2023-B
Medium Inertia Servo Motor	ECMA-E \triangle 1320 \square S
Power Cables (Without Brake)	ASDBCAPW120X
Power Cables (With Brake)	ASDBCAPW130X
Power Connectors	ASD-CAPW1000
Encoder Cables	ASDBCAEN100X
Encoder Connectors	ASDBCAEN1000

(X=3 indicates that the cable length is 3m; X=5 indicates that the cable length is 5m)

2kW Servo Drive and 2kW Medium Inertia Servo Motor

Servo Drive	ASD-B2-2023-B
Medium Inertia Servo Motor	ECMA-E \triangle 1820 \square S
Power Cables (Without Brake)	ASD-CAPW220X
Power Cables (With Brake)	ASD-CAPW230X
Power Connectors	ASD-CAPW2000
Encoder Cables	ASDBCAEN100X
Encoder Connectors	ASDBCAEN1000

(X=3 indicates that the cable length is 3m; X=5 indicates that the cable length is 5m)

2kW Servo Drive and 1.3kW Medium High Inertia Servo Motor

Servo Drive	ASD-B2-2023-B
Medium High Inertia Servo Motor	ECMA-F11313 \square S
Power Cables (Without Brake)	ASDBCAPW120X
Power Cables (With Brake)	ASDBCAPW130X
Power Connectors	ASD-CAPW1000
Encoder Cables	ASDBCAEN100X
Encoder Connectors	ASDBCAEN1000

(X=3 indicates that the cable length is 3m; X=5 indicates that the cable length is 5m)

2kW Servo Drive and 1.8kW Medium High Inertia Servo Motor

Servo Drive	ASD-B2-2023-B
Medium High Inertia Servo Motor	ECMA-F11318 \square S
Power Cables (Without Brake)	ASDBCAPW120X
Power Cables (With Brake)	ASDBCAPW130X
Power Connectors	ASD-CAPW1000
Encoder Cables	ASDBCAEN100X
Encoder Connectors	ASDBCAEN1000

(X=3 indicates that the cable length is 3m; X=5 indicates that the cable length is 5m)

3kW Servo Drive and 3kW Low Inertia Servo Motor

Servo Drive	ASD-B2-3023-B
Low Inertia Servo Motor	ECMA-C \triangle 1330 \square 4
Power Cables (Without Brake)	ASDBCAPW120X
Power Cables (With Brake)	ASDBCAPW130X
Power Connectors	ASD-CAPW1000
Encoder Cables	ASDBCAEN100X
Encoder Connectors	ASDBCAEN1000

(X=3 indicates that the cable length is 3m; X=5 indicates that the cable length is 5m)

3kW Servo Drive and 3kW Medium Inertia Servo Motor

Servo Drive	ASD-B2-3023-B
Medium Inertia Servo Motor	ECMA-E \triangle 1830 \square S
Power Cables (Without Brake)	ASD-CAPW220X
Power Cables (With Brake)	ASD-CAPW230X
Power Connectors	ASD-CAPW2000
Encoder Cables	ASDBCAEN100X
Encoder Connectors	ASDBCAEN1000

(X=3 indicates that the cable length is 3m; X=5 indicates that the cable length is 5m)

3kW Servo Drive and 3.5kW Medium Inertia Servo Motor

Servo Drive	ASD-B2-3023-B
Medium Inertia Servo Motor	ECMA-E \triangle 1835 \square S
Power Cables (Without Brake)	ASD-CAPW220X
Power Cables (With Brake)	ASD-CAPW230X
Power Connectors	ASD-CAPW2000
Encoder Cables	ASDBCAEN100X
Encoder Connectors	ASDBCAEN1000

(X=3 indicates that the cable length is 3m; X=5 indicates that the cable length is 5m)

3kW Servo Drive and 3kW Medium High Inertia Servo Motor

Servo Drive	ASD-B2-3023-B
Medium High Inertia Servo Motor	ECMA-F \triangle 1830 \square S
Power Cables (Without Brake)	ASD-CAPW220X
Power Cables (With Brake)	ASD-CAPW230X
Power Connectors	ASD-CAPW2000
Encoder Cables	ASDBCAEN100X
Encoder Connectors	ASDBCAEN1000

(X=3 indicates that the cable length is 3m; X=5 indicates that the cable length is 5m)

Other Accessories (for ASDA-B2 Series all models)

Description	Delta Part Number
Communication Cable between Servo Drive and Computer	ASD-CARS0003
Regenerative Resistor 400W 100 Ω	BR400W040
Regenerative Resistor 1kW 1000 Ω	BR1K0W020



Smarter. Greener. Together.

Industrial Automation Headquarters

Delta Electronics, Inc.

Taoyuan Technology Center
No.18, Xinglong Rd., Taoyuan District,
Taoyuan City 33068, Taiwan
TEL: 886-3-362-6301 / FAX: 886-3-371-6301

Asia

Delta Electronics (Shanghai) Co., Ltd.

No.182 Minyu Rd., Pudong Shanghai, P.R.C.
Post code : 201209
TEL: 86-21-6872-3988 / FAX: 86-21-6872-3996
Customer Service: 400-820-9595

Delta Electronics (Japan), Inc.

Tokyo Office
Industrial Automation Sales Department
2-1-14 Shibadaimon, Minato-ku
Tokyo, Japan 105-0012
TEL: 81-3-5733-1155 / FAX: 81-3-5733-1255

Delta Electronics (Korea), Inc.

Seoul Office
1511, 219, Gasan Digital 1-Ro., Geumcheon-gu,
Seoul, 08501 South Korea
TEL: 82-2-515-5305 / FAX: 82-2-515-5302

Delta Energy Systems (Singapore) Pte Ltd.

4 Kaki Bukit Avenue 1, #05-04, Singapore 417939
TEL: 65-6747-5155 / FAX: 65-6744-9228

Delta Electronics (India) Pvt. Ltd.

Plot No.43, Sector 35, HSIIDC Gurgaon,
PIN 122001, Haryana, India
TEL: 91-124-4874900 / FAX : 91-124-4874945

Delta Electronics (Thailand) PCL.

909 Soi 9, Moo 4, Bangpoo Industrial Estate (E.P.Z),
Pattana 1 Rd., T.Phraksa, A.Muang,
Samutprakarn 10280, Thailand
TEL: 66-2709-2800 / FAX : 662-709-2827

Delta Energy Systems (Australia) Pty Ltd.

Unit 20-21/45 Normanby Rd., Notting Hill Vic 3168, Australia
TEL: 61-3-9543-3720

Americas

Delta Electronics (Americas) Ltd.

Raleigh Office
P.O. Box 12173, 5101 Davis Drive,
Research Triangle Park, NC 27709, U.S.A.
TEL: 1-919-767-3813 / FAX: 1-919-767-3969

Delta Greentech (Brasil) S/A

São Paulo Office
Rua Itapeva, 26 – 3º Andar - Bela Vista
CEP: 01332-000 – São Paulo – SP - Brasil
TEL: 55-11-3530-8642 / 55-11-3530-8640

Delta Electronics International Mexico S.A. de C.V.

Mexico Office
Vía Dr. Gustavo Baz No. 2160, Colonia La Loma,
54060 Tlalnepanitla Estado de Mexico
TEL: 52-55-2628-3015 #3050/3052

EMEA

Headquarters: Delta Electronics (Netherlands) B.V.

Sales: Sales.IA.EMEA@deltaww.com
Marketing: Marketing.IA.EMEA@deltaww.com
Technical Support: iatechnicalsupport@deltaww.com
Customer Support: Customer-Support@deltaww.com
Service: Service.IA.emea@deltaww.com
TEL: +31(0)40 800 3800

BENELUX: Delta Electronics (Netherlands) B.V.

De Witbogt 20, 5652 AG Eindhoven, The Netherlands
Mail: Sales.IA.Benelux@deltaww.com
TEL: +31(0)40 800 3800

DACH: Delta Electronics (Netherlands) B.V.

Coesterweg 45, D-59494 Soest, Germany
Mail: Sales.IA.DACH@deltaww.com
TEL: +49(0)2921 987 0

France: Delta Electronics (France) S.A.

ZI du bois Challand 2, 15 rue des Pyrénées,
Lisses, 91090 Evry Cedex, France
Mail: Sales.IA.FR@deltaww.com
TEL: +33(0)1 69 77 82 60

Iberia: Delta Electronics Solutions (Spain) S.L.U

Ctra. De Villaverde a Vallecas, 265 1º Dcha Ed.
Hormigueras – P.I. de Vallecas 28031 Madrid
TEL: +34(0)91 223 74 20

C/Llull, 321-329 (Edifici CINC) | 22@Barcelona, 08019 Barcelona

Mail: Sales.IA.Iberia@deltaww.com
TEL: +34 93 303 00 60

Italy: Delta Electronics (Italy) S.r.l.

Ufficio di Milano Via Senigallia 18/2 20161 Milano (MI)
Piazza Grazioli 18 00186 Roma Italy
Mail: Sales.IA.Italy@deltaww.com
TEL: +39 02 64672538

Russia: Delta Energy System LLC

Vereyskaya Plaza II, office 112 Vereyskaya str.
17 121357 Moscow Russia
Mail: Sales.IA.RU@deltaww.com
TEL: +7 495 644 3240

Turkey: Delta Greentech Elektronik San. Ltd. Sti. (Turkey)

Şerifali Mah. Hendem Cad. Kule Sok. No:16-A
34775 Ümraniye – İstanbul
Mail: Sales.IA.Turkey@deltaww.com
TEL: + 90 216 499 9910

GCC: Delta Energy Systems AG (Dubai BR)

P.O. Box 185668, Gate 7, 3rd Floor, Hamarain Centre
Dubai, United Arab Emirates
Mail: Sales.IA.MEA@deltaww.com
TEL: +971(0)4 2690148

Egypt + North Africa: Delta Electronics

511 Cairo Business Plaza, North 90 street,
New Cairo, Cairo, Egypt
Mail: Sales.IA.MEA@deltaww.com

*We reserve the right to change the information in this catalogue without prior notice.