

Automation for a Changing World

# Delta AC Servo Drive & Motor ASDA-M Series



[www.deltaww.com](http://www.deltaww.com)

 **DELTA**  
Smarter. Greener. Together.



## Introduction to the ASDA-M Series

Delta's ASDA-M Series is a three-axis intelligent AC servo system which has successfully integrated control, motion and drive into one servo system and is ideal for multi-axis motion control applications. With this innovative 3-in-1 design, the ASDA-M demonstrates a perfect combination of motion controller and servo system, and has received excellent feedback from customers.

The development of the ASDA-M is in response to positive market feedback on our ASDA-A2. The ASDA-M offers high resolution, high frequency response, built-in electronic cam (E-Cam), auto notch filters, vibration suppression, full-closed loop control, friction compensation and a more flexible position register control PR mode. It also provides strong motion control functions and advanced design to meet a variety of applications for all types of industrial automation machines.

The ASDA-M goes beyond the typical servo drive. It includes 3 axes servo drives in one frame to provide 3 axes synchronous motion control and it supports real-time data exchange among 3 axes without any time delay. Users can perform 3-axis linear / arc / helical interpolation functions easily. In addition, the ASDA-M features a new gantry control function for synchronous control that is precisely adapted to pure rigid mechanical systems. The upgraded ASDA-Soft software provides a built-in contour analysis function to strengthen system diagnosis capabilities.

The ASDA-M supports DMCNET and CANopen communication protocols. Connecting to DMCNET extension digital input and output modules increases system extension flexibility and control needed for application customization. The CANopen and RS-485 interfaces enable the servo system to integrate with other parts of the automation more efficiently and effectively.

The ASDA-M is a highly-integrated servo system that demonstrates Delta's expertise in innovation and integration, giving a new definition to servo system and offering a new automation vision for a changing world.

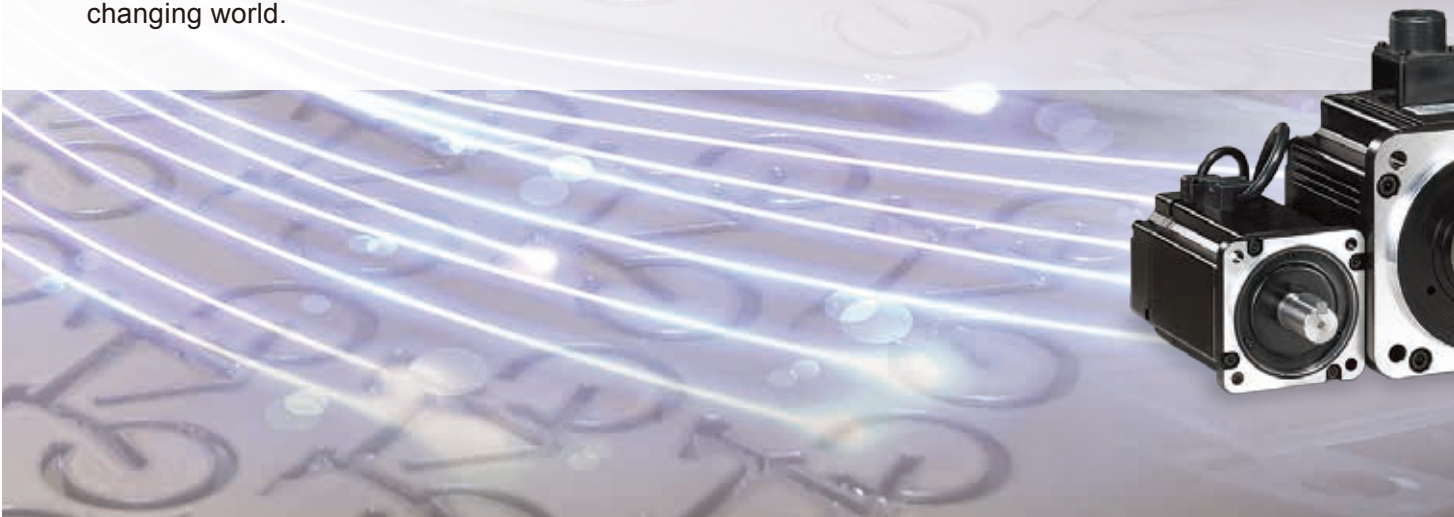



## Table of Contents

1	Introduction to the ASDA-M Series
3	ASDA-M Series Features
15	ASDA-Soft Configuration Software
17	Servo Drive and Servo Motor Combinations
18	Product Line-up
19	Model Name Explanation
20	Servo Drive Specifications
21	Servo Drive Dimensions
23	Wiring
28	Servo Motor Features
29	Servo Motor Specifications
31	Servo Motor Dimensions
34	DMCNET Remote Modules
37	Part Names and Functions
39	Optional Accessories
41	Optional Cables and Connectors
46	Accessories Combinations
50	Safety Information
50	Regenerative Resistor Specifications

**USB Connection Port  
for Direct Connection  
to Personal Computers  
or Notebooks**



**ASDA-M Series  
Servo System**



**Real Time I/O  
(18 Inputs / 9  
Outputs)**

**Z-Axis**

**Y-Axis**

**X-Axis**



## **ASDA-M Series Features**

### **Highly Integrated System**

- Built-in motion control and PLC functions
- Multi-axis synchronous interpolation
- Advanced gantry control
- Flexible electronic cam (E-Cam) function
- High-speed frequency response
- Excellent vibration and resonance suppression
- High-precision full-closed loop control
- Versatile PR mode
- Real-time Capture and Compare functions

## HMC Series Controller with Human Machine Interface



Supports  
DMCNET  
Communication  
Protocol

ASDA-A2 Series Servo Drives  
ASD-A2- \* -F

DMCNET  
High-Speed Motion Control

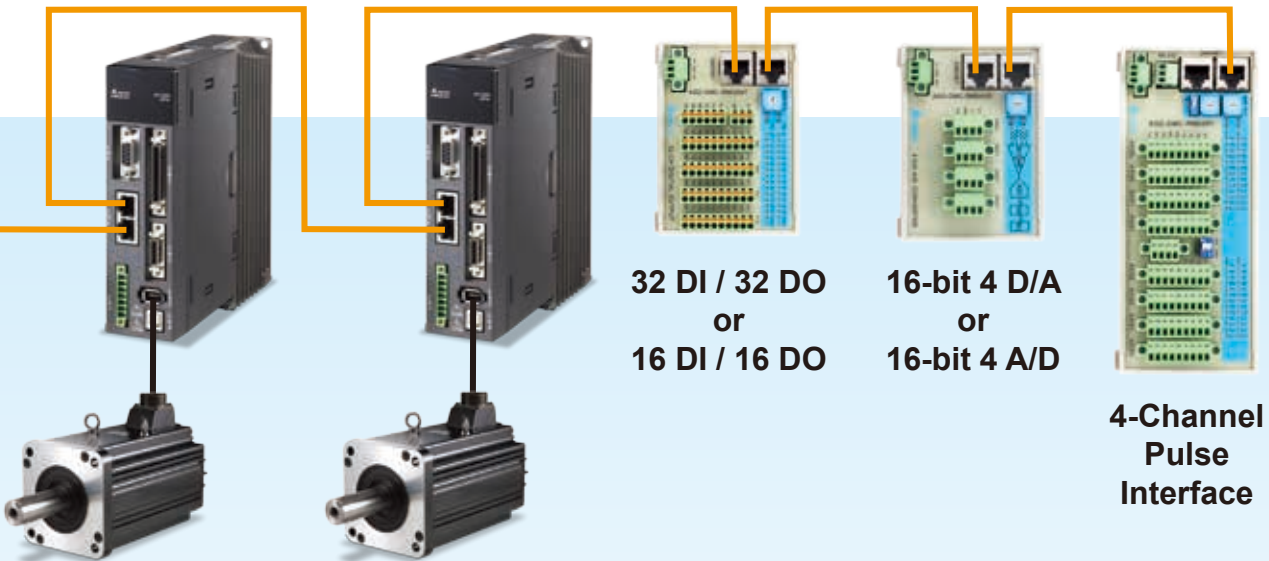

### Real Time, Reliable and High-Speed Motion Control Network

- Supports DMCNET and CANopen communication protocols.
- With the aid of Delta's Human Machine Controller (HMC), it can establish an integrated system configuration by DMCNET.
- Supports DMCNET interface for I/O extension modules.

### High Precision, High Performance

- Supports incremental type and absolute type encoders.
- Incremental type encoder provides up to 1280000 p/rev resolution for high-precision positioning.

# ASDA-M Series Features

## Multi-Axis Synchronous Interpolation

- A variety of interpolation functions maximize the motion control performance of the ASDA-M Series.
- Interpolation commands are generated by the algorithm from the ASDA-M Series to offer high synchronous control accuracy.

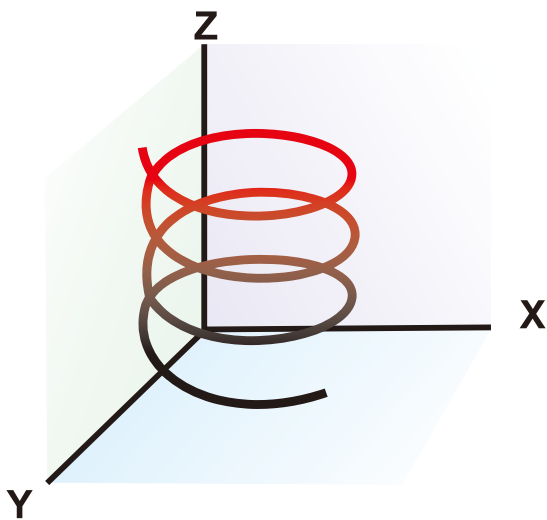

3-Axis Helical Interpolation

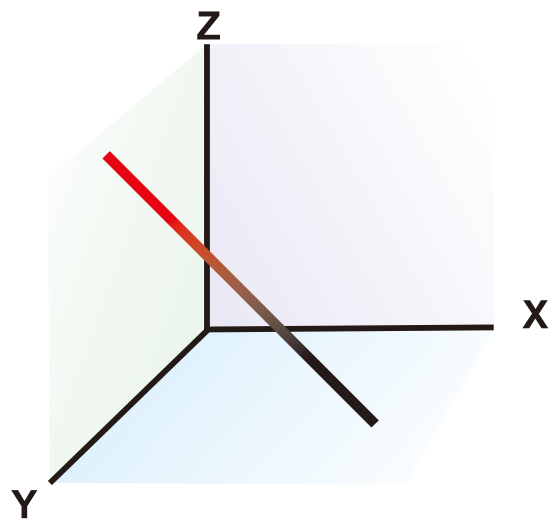

3-Axis Linear Interpolation

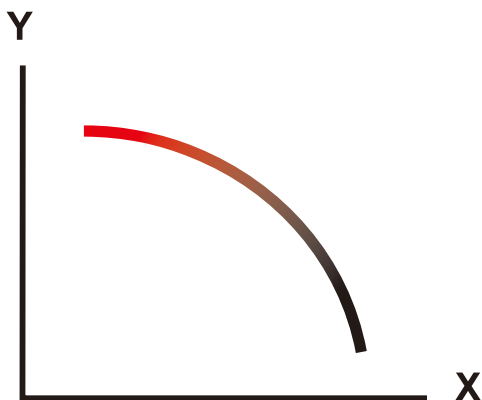

2-Axis Arc Interpolation



2-Axis Linear Interpolation



## Advanced Gantry Control

- A large amount of data and calculations among two axes can be completed with the same DSP (Digital Signal Processor). Precise synchronization is easy to achieve. This greatly increases the efficiency and performance of gantry control.
- In rigid or general mechanical systems, no matter if the loading on multiple axes is equal or not, the ASDA-M Series can perform precise motion control and drive each axis simultaneously.



# ASDA-M Series Features

## Distributed Motion Control System - HMC Series serves as a Master

- Up to 10Mbps communication bandwidth is provided. It is capable of controlling 12 slave units within 1ms.
- With the aid of Delta's Controller with Human Machine Interface HMC Series, it offers the best combination of distributed systems to increase effectiveness.

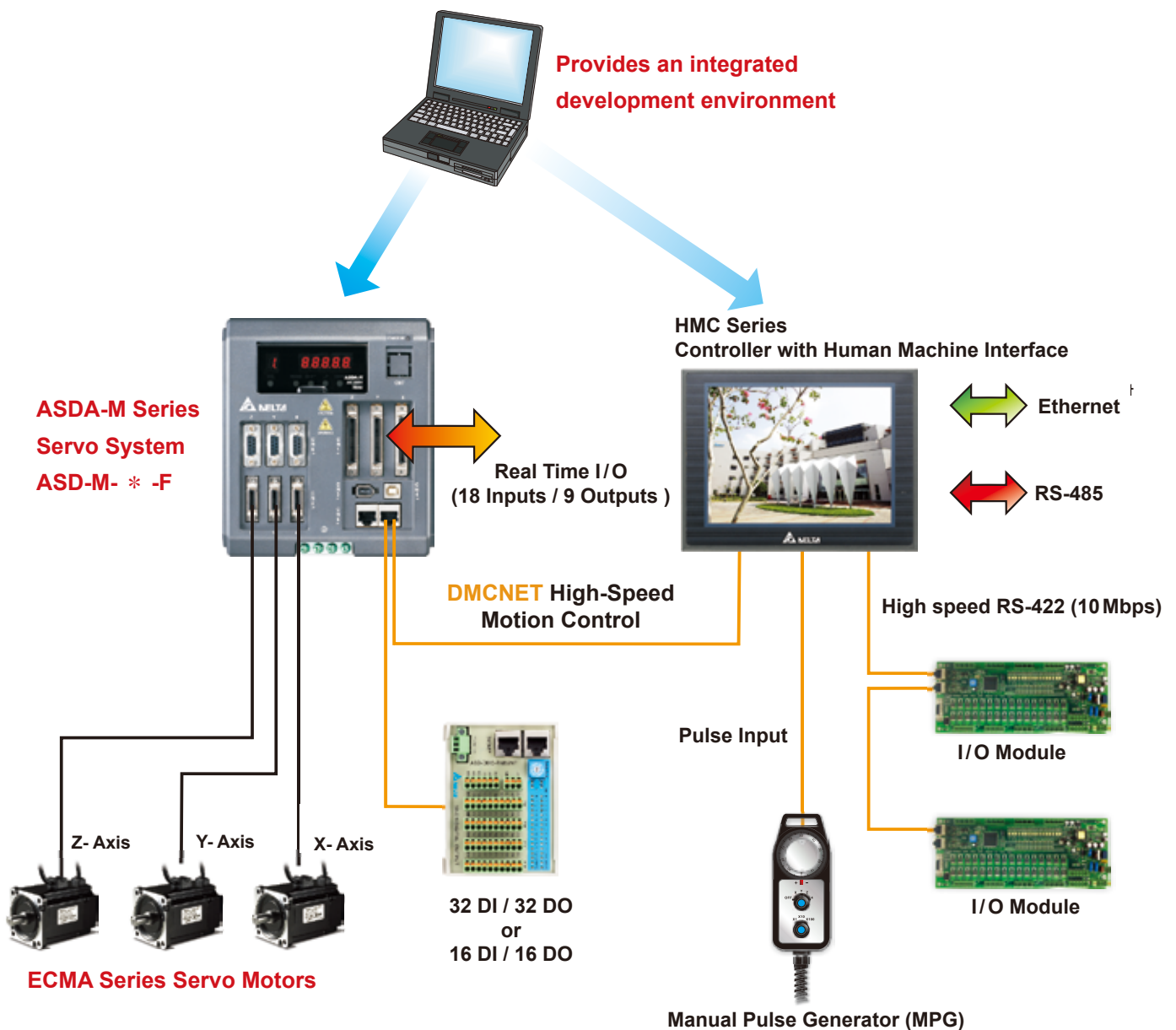



## Contour Analysis Function in ASDA-Soft

- Capable of monitoring the data of three axes simultaneously.
- Provides 2-axis surface trajectory display function for tracking and analysis.
- Capable of monitoring position commands and trajectory changes for contour error analysis.

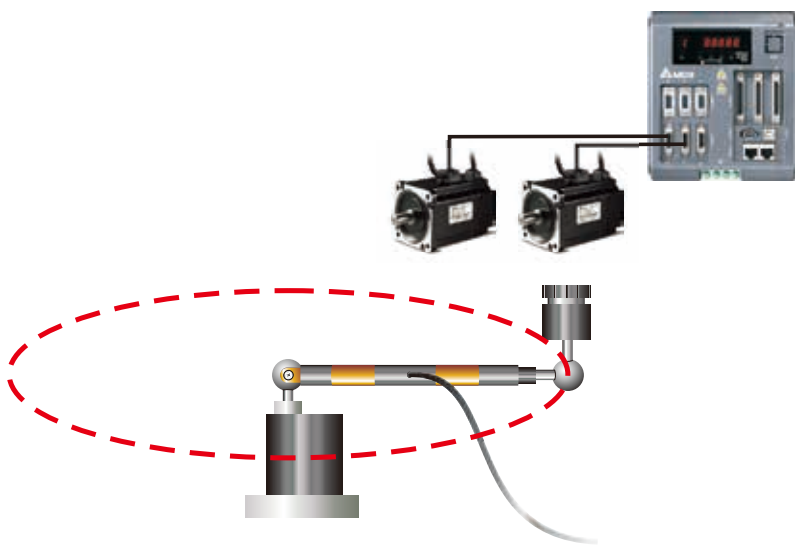

Contour Test

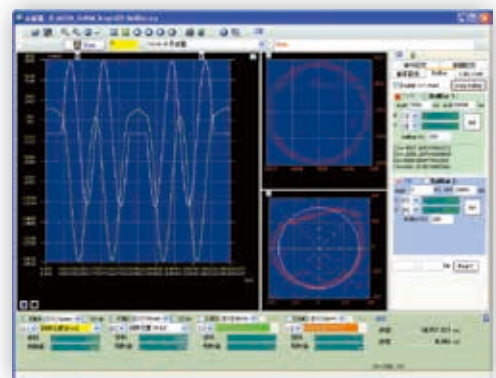

Contour analysis of position feedback signals between two servo motors

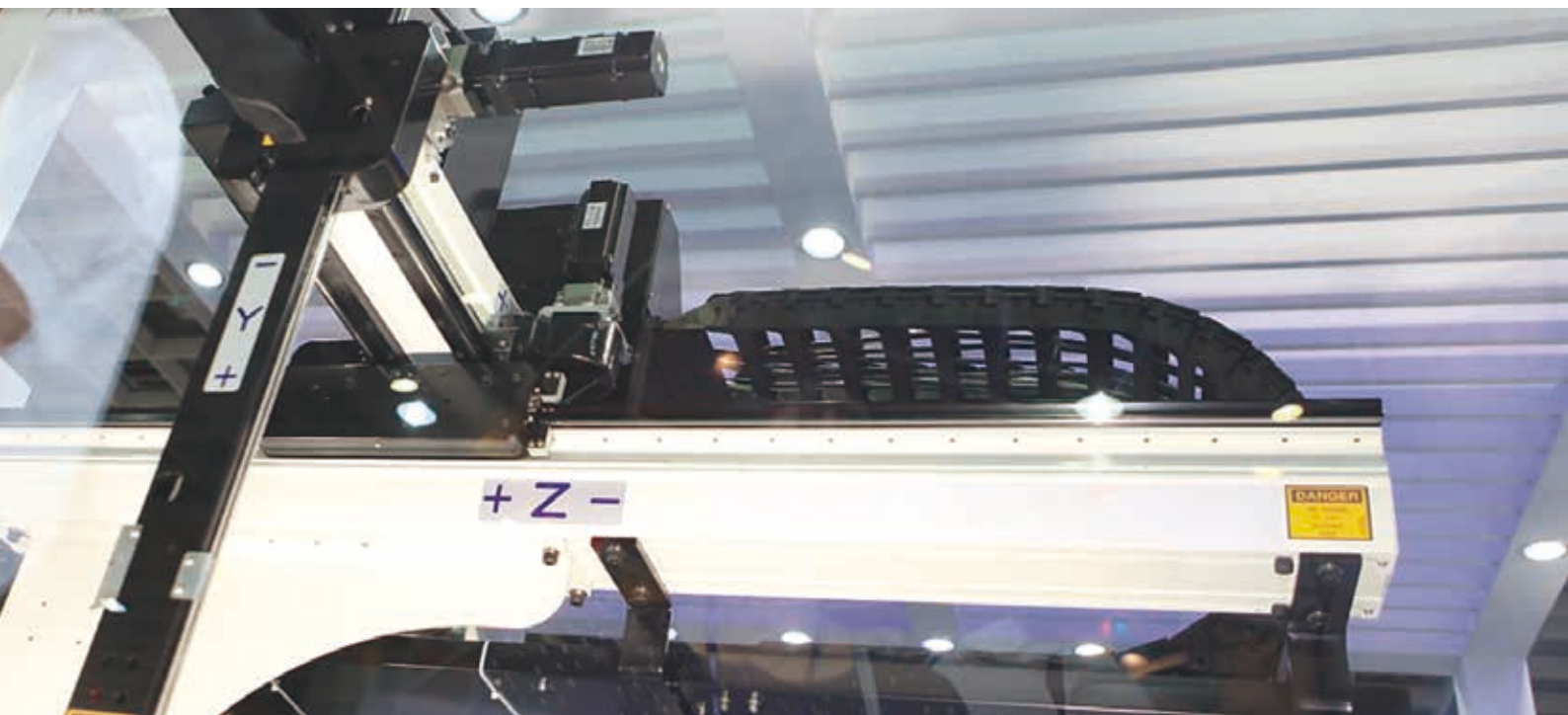

# ASDA-M Series Features

## Flexible Electronic Cam (E-Cam)

- A flexible mechanism that can be easily configured with three slave axes or only one master axis.
- The switch of slave and master axes is determined by parameter settings that users can change freely.
- ASDA-Soft configuration software provides E-Cam profile editing functions for easy tuning and adjustment.

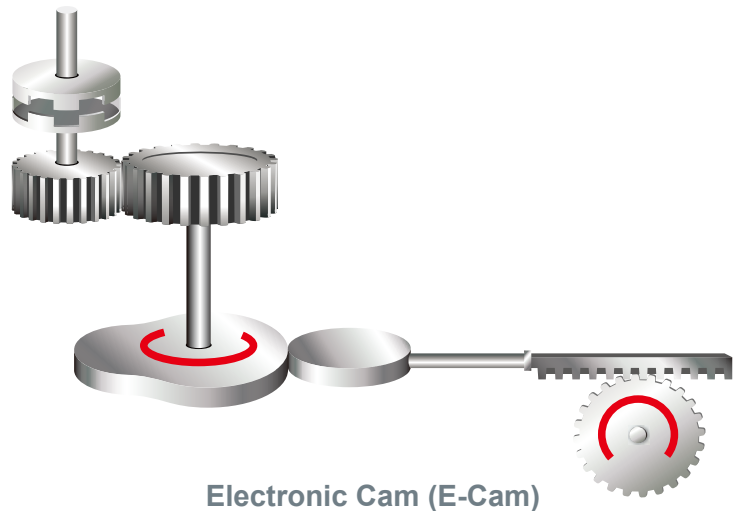

## High Responsiveness

- Up to 1 kHz frequency response.
- Settling time below 1 ms.
- Takes only 7ms to accelerate from -3000 r/min to 3000 r/min.  
(Note: The test record of a 400W motor with 60mm frame size)

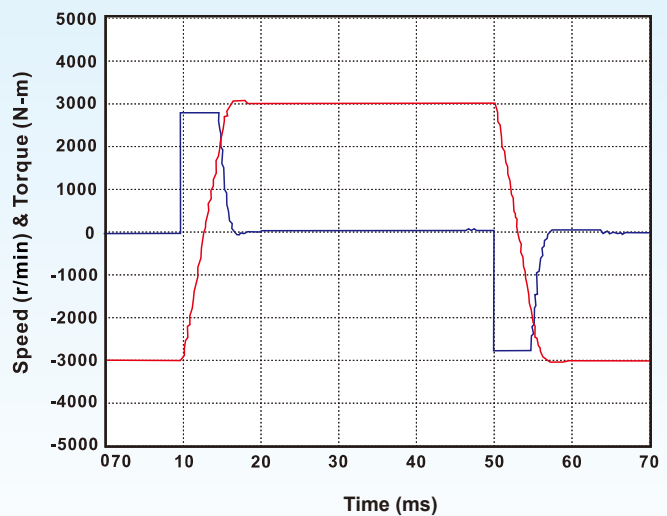
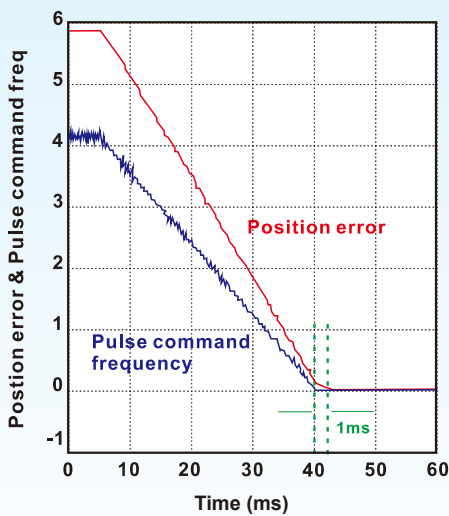

## Excellent Suppression Functions

- Vibration Suppression (Low Frequency)

Two vibration suppression filters are provided for long arm systems to minimize the vibration at machine edges effectively.

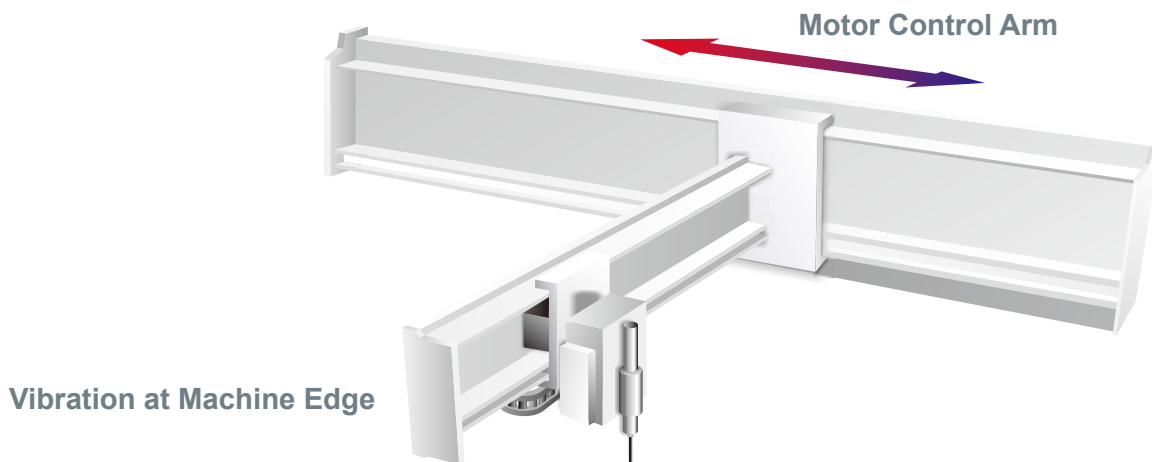

- Resonance Suppression (High Frequency)

Two auto notch filters and one manual notch filter are provided to suppress mechanical resonance efficiently.

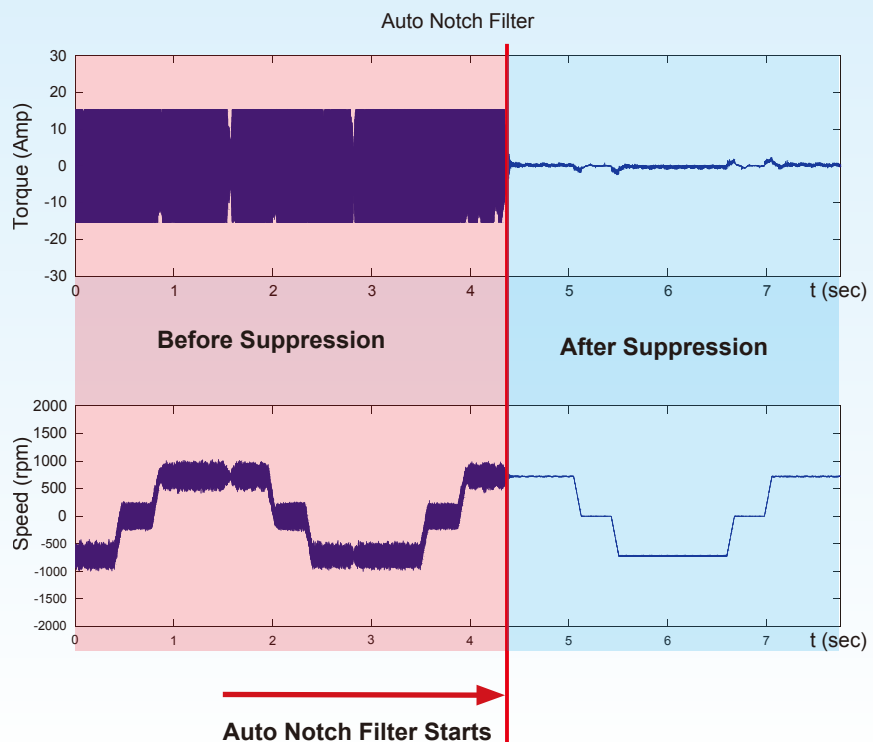

# ASDA-M Series Features

## Full-Closed Loop Control Function

- Reduces the effects of backlash and flexibility from the machine and ensures the accuracy of positioning.

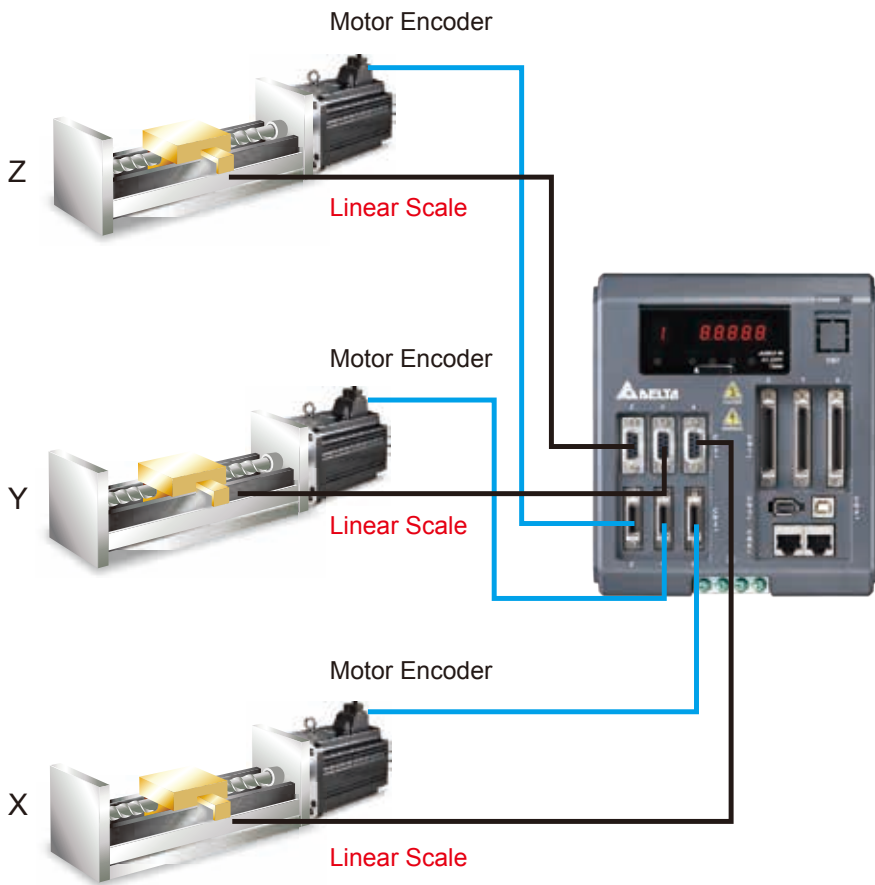

## Versatile PR Mode

- ASDA-Soft configuration software offers a parameters editing function for different procedures planning.
- In PR mode, 99 procedures can be applied for three axes to enhance the ability of multiple points and continuous position control.
- Motion profile such as target position, acceleration and deceleration control can be changed instantaneously.
- Multi-axis synchronous motion movement is ideal for applications requiring high synchronous control accuracy and variable speed.
- 35 Homing methods / Jump mode / Write parameter mode / Single-axis speed mode / Single-axis position mode / Multi-axis linear interpolation mode / 2-Axis arc interpolation mode / 3-Axis helical interpolation / Vector speed change mode, nine kinds of PR modes are available for selection.
- Supports absolute commands, relative commands, incremental commands, and high-speed capture commands for accurate positioning control.

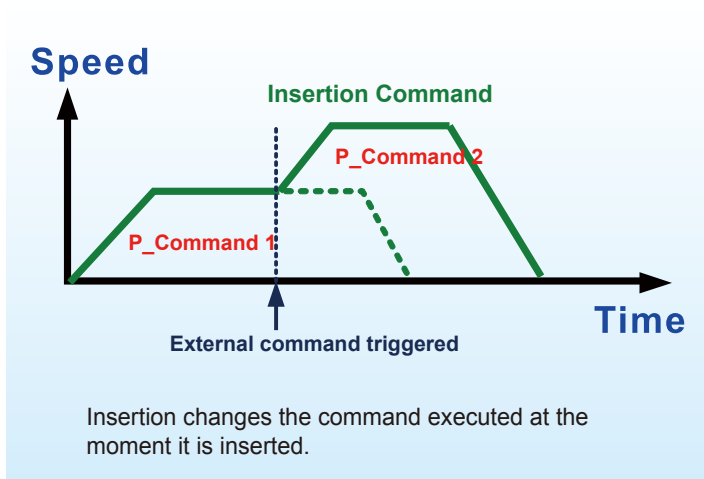
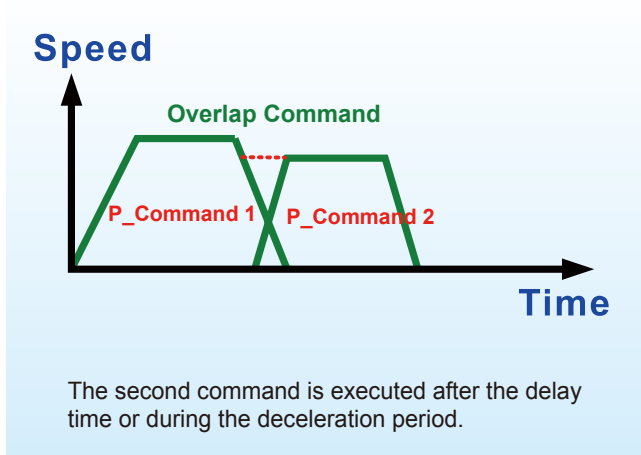
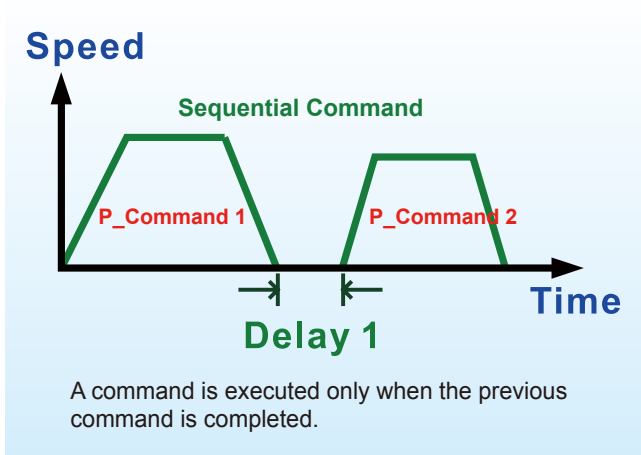

# ASDA-M Series Features

## Real Time Capture and Compare Functions

### Position Latch Function (Capture)

- Captures the coordinate value on the reference axis with a response time less than 8μs.
- It can be used to do mark tracking.
- Maximum 1500 records.

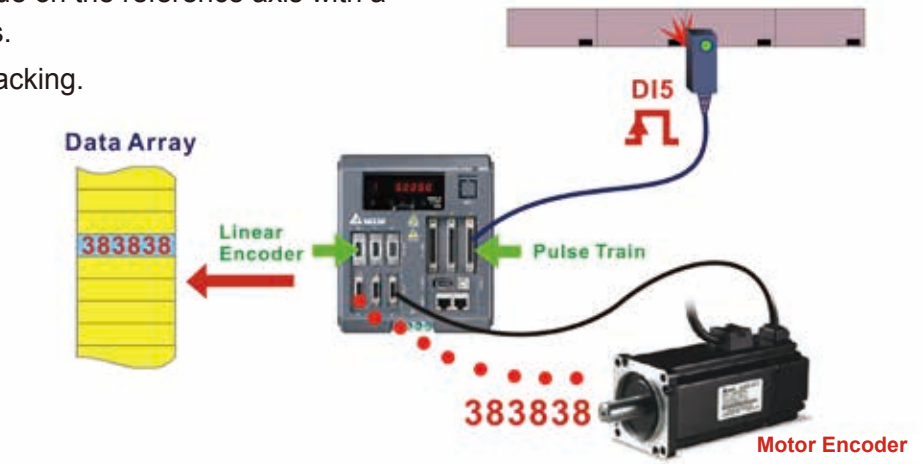

When DI5 is triggered, the latched position is recorded in Data Array.

### Position Latch Function (Capture)

### Position Detection Function (Compare)

- Promptly outputs pulses upon the axis reaching the target position with a response time less than 5μs.
- It can be used for CCD camera applications.
- Maximum 1500 records.

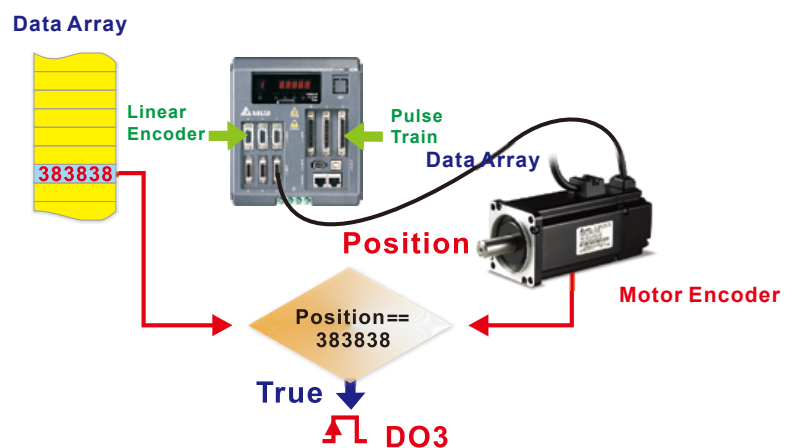

When the record in Data Array is the same as the detected position, DO3 will output.

### Position Detection Function (Compare)

## High-Accuracy Positioning

- ECMA Series servo motors feature incremental encoders with 20-bit resolution (1280000 p/rev) which can eliminate unstable commands at low speed, smooth motor operation and enhance the accuracy of positioning.
- Supports 17-bit absolute system.

Incremental encoder  
resolution: 1280000 p/rev

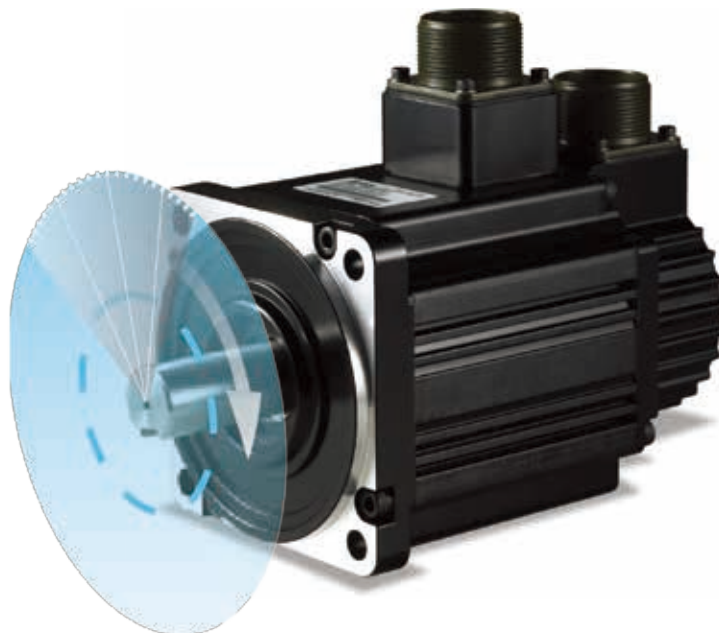

## Reliable Communication on High-Speed Motion Control Network

- Complies with CANopen DS301 protocol, providing up to 1Mbps communication rate.
- Capable of connecting to maximum servo systems in position, speed and torque modes through CANopen communication.

### Delta High-speed Communication Network



CANopen Master Module

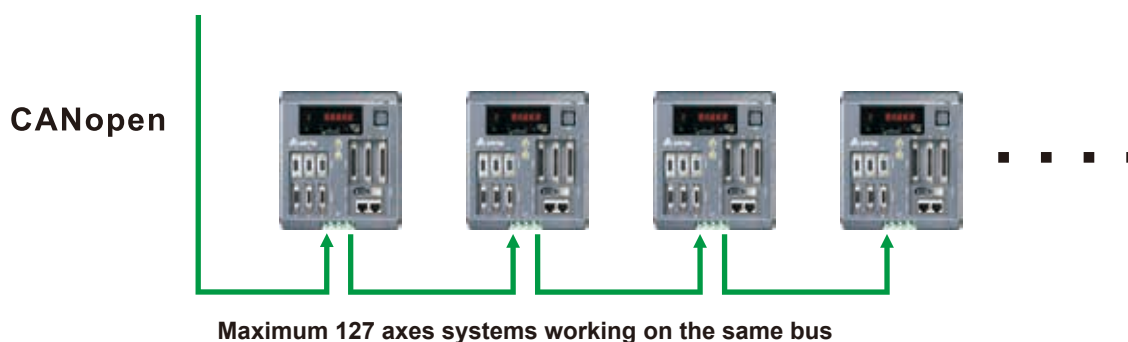

# ASDA-Soft Configuration Software

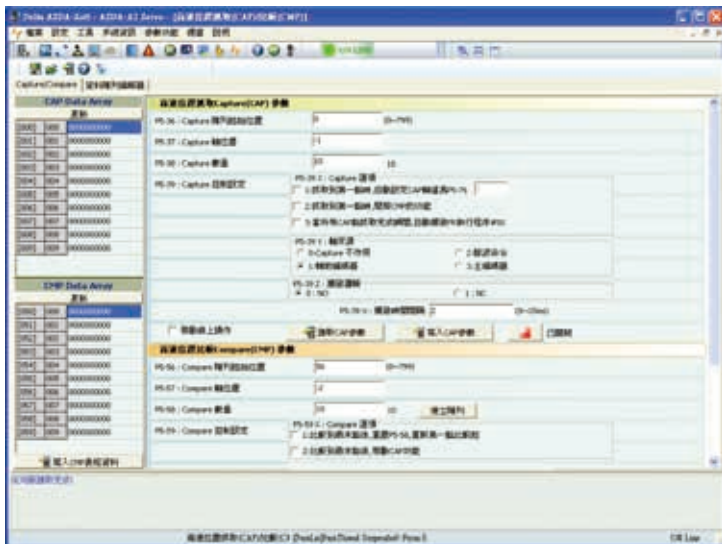

- Strong Capture and Compare functions for position latch and detection help you complete system configuration quickly.

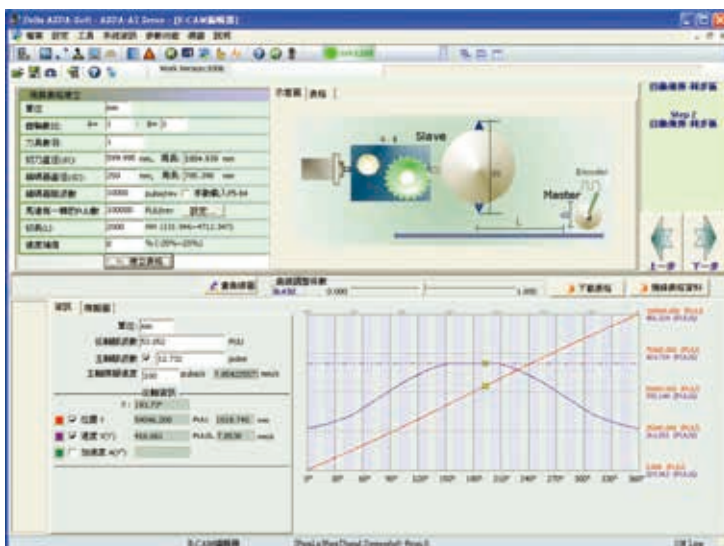

- User-friendly E-Cam editing interface is provided for designing E-Cam profiles. Quick settings for flying shear and rotary cut applications are also offered.



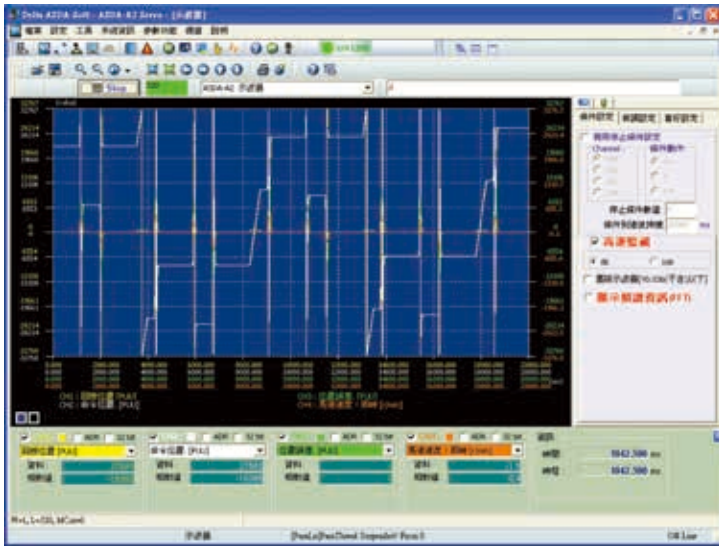

- Versatile monitoring function, similar to a digital oscilloscope is able to quickly record the status and data of each axis. Real-time monitoring is easy.



Delta Electronics, Inc. All rights reserved

異常項目	異常說明	異常處理
異常項目1	異常說明1	異常處理1
異常項目2	異常說明2	異常處理2
異常項目3	異常說明3	異常處理3
異常項目4	異常說明4	異常處理4
異常項目5	異常說明5	異常處理5
異常項目6	異常說明6	異常處理6
異常項目7	異常說明7	異常處理7
異常項目8	異常說明8	異常處理8
異常項目9	異常說明9	異常處理9
異常項目10	異常說明10	異常處理10

- Convenient alarm display function is capable of troubleshooting the system easily and recommending timely corrective actions.

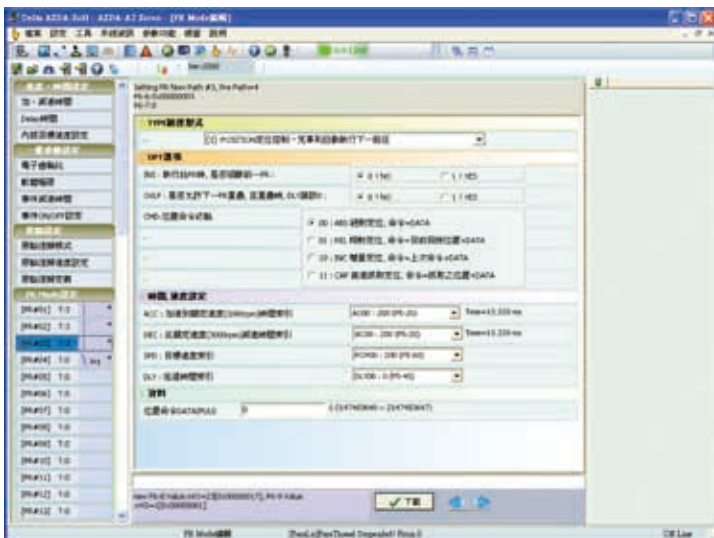



- Easy-to-use editing interface is designed for new and enhanced PR control mode. Homing, point-to-point and other motion control functions for multi-axis positioning control are easy to achieve.

# Servo Drive and Servo Motor Combinations

Servo Drives and Servo Motors	Examples
<p><b>Servo Drive</b></p> <div style="border: 1px solid black; padding: 5px; width: fit-content; margin: 0 auto;">750W Servo Drive ASD-M-0721- □</div> <p><b>Servo Motor</b></p> <div style="display: flex; justify-content: space-around; align-items: center;"> <div style="border: 1px solid black; width: 40px; height: 60px;"></div> <div style="border: 1px solid black; width: 40px; height: 60px;"></div> <div style="border: 1px solid black; padding: 5px; font-size: 8px;">Options: 100W 200W 400W 750W</div> </div> <p style="text-align: center;"><b>Output Capacity for One Servo Motor : 750W Max.</b></p>	<div style="display: flex; justify-content: space-around;"> <div style="text-align: center;"> <div style="border: 1px solid black; padding: 5px; width: 100px; height: 20px;">750W Servo Drive</div> <div style="display: flex; justify-content: space-around; margin-top: 10px;"> <div style="border: 1px solid black; width: 20px; height: 60px; margin: 0 5px;">750W</div> <div style="border: 1px solid black; width: 20px; height: 60px; margin: 0 5px;">750W</div> <div style="border: 1px solid black; width: 20px; height: 60px; margin: 0 5px;">750W</div> </div> </div> <div style="text-align: center;"> <div style="border: 1px solid black; padding: 5px; width: 100px; height: 20px;">750W Servo Drive</div> <div style="display: flex; justify-content: space-around; margin-top: 10px;"> <div style="border: 1px solid black; width: 20px; height: 60px; margin: 0 5px;">100W</div> <div style="border: 1px solid black; width: 20px; height: 60px; margin: 0 5px;">400W</div> <div style="border: 1px solid black; width: 20px; height: 60px; margin: 0 5px;">750W</div> </div> </div> </div>
<p><b>Servo Drive</b></p> <div style="border: 1px solid black; padding: 5px; width: fit-content; margin: 0 auto;">750W Servo Drive ASD-M-0721- □ S</div> <p><b>Servo Motors</b></p> <div style="display: flex; justify-content: space-around; align-items: center;"> <div style="border: 1px solid black; padding: 5px; font-size: 8px;">Options: 100W 200W 400W 750W</div> <div style="border: 1px solid black; padding: 5px; font-size: 8px;">Options: 100W 200W 400W 750W</div> </div> <p style="text-align: center;"><b>Output Capacity for One Servo Motor : 750W Max.</b></p>	<div style="display: flex; justify-content: space-around;"> <div style="text-align: center;"> <div style="border: 1px solid black; padding: 5px; width: 100px; height: 20px;">750W Servo Drive</div> <div style="display: flex; justify-content: space-around; margin-top: 10px;"> <div style="border: 1px solid black; width: 20px; height: 60px; margin: 0 5px;">750W</div> <div style="border: 1px solid black; width: 20px; height: 60px; margin: 0 5px;">750W</div> </div> </div> <div style="text-align: center;"> <div style="border: 1px solid black; padding: 5px; width: 100px; height: 20px;">750W Servo Drive</div> <div style="display: flex; justify-content: space-around; margin-top: 10px;"> <div style="border: 1px solid black; width: 20px; height: 60px; margin: 0 5px;">750W</div> <div style="border: 1px solid black; width: 20px; height: 60px; margin: 0 5px;"></div> </div> </div> </div>
<p><b>Servo Drive</b></p> <div style="border: 1px solid black; padding: 5px; width: fit-content; margin: 0 auto;">1.5kW Servo Drive ASD-M-1521- □</div> <p><b>Servo Motors</b></p> <div style="display: flex; justify-content: space-around; align-items: center;"> <div style="border: 1px solid black; padding: 5px; font-size: 8px;">Options: 750W 1kW 1.5kW</div> <div style="border: 1px solid black; padding: 5px; font-size: 8px;">Options: 750W 1kW 1.5kW</div> <div style="border: 1px solid black; padding: 5px; font-size: 8px;">Options: 750W 1kW 1.5kW</div> </div> <p style="text-align: center;"><b>Output Capacity for One Servo Motor: 1.5kW Max.</b></p>	<div style="display: flex; justify-content: space-around;"> <div style="text-align: center;"> <div style="border: 1px solid black; padding: 5px; width: 100px; height: 20px;">1.5kW Servo Drive</div> <div style="display: flex; justify-content: space-around; margin-top: 10px;"> <div style="border: 1px solid black; width: 20px; height: 60px; margin: 0 5px;"></div> <div style="border: 1px solid black; width: 20px; height: 60px; margin: 0 5px;">1.5kW</div> <div style="border: 1px solid black; width: 20px; height: 60px; margin: 0 5px;">1.5kW</div> </div> </div> <div style="text-align: center;"> <div style="border: 1px solid black; padding: 5px; width: 100px; height: 20px;">1.5kW Servo Drive</div> <div style="display: flex; justify-content: space-around; margin-top: 10px;"> <div style="border: 1px solid black; width: 20px; height: 60px; margin: 0 5px;">1.5kW</div> <div style="border: 1px solid black; width: 20px; height: 60px; margin: 0 5px;">1.0kW</div> <div style="border: 1px solid black; width: 20px; height: 60px; margin: 0 5px;">750W</div> </div> </div> </div>
<p><b>Servo Drive</b></p> <div style="border: 1px solid black; padding: 5px; width: fit-content; margin: 0 auto;">1.5kW Servo Drive ASD-M-1521- □ S</div> <p><b>Servo Motors</b></p> <div style="display: flex; justify-content: space-around; align-items: center;"> <div style="border: 1px solid black; padding: 5px; font-size: 8px;">Options: 750W 1kW 1.5kW</div> <div style="border: 1px solid black; padding: 5px; font-size: 8px;">Options: 750W 1kW 1.5kW</div> </div> <p style="text-align: center;"><b>Output Capacity for One Servo Motor: 1.5kW Max.</b></p>	<div style="display: flex; justify-content: space-around;"> <div style="text-align: center;"> <div style="border: 1px solid black; padding: 5px; width: 100px; height: 20px;">1.5kW Servo Drive</div> <div style="display: flex; justify-content: space-around; margin-top: 10px;"> <div style="border: 1px solid black; width: 20px; height: 60px; margin: 0 5px;">1.5kW</div> <div style="border: 1px solid black; width: 20px; height: 60px; margin: 0 5px;">1.5kW</div> </div> </div> <div style="text-align: center;"> <div style="border: 1px solid black; padding: 5px; width: 100px; height: 20px;">1.5kW Servo Drive</div> <div style="display: flex; justify-content: space-around; margin-top: 10px;"> <div style="border: 1px solid black; width: 20px; height: 60px; margin: 0 5px;">1.5kW</div> <div style="border: 1px solid black; width: 20px; height: 60px; margin: 0 5px;">1.0kW</div> </div> </div> </div>

# Product Line-up

Servo Drives			
		750W	1.5kW
		ASD-M-0721-□ ASD-M-0721-□ S	ASD-M-1521-□ ASD-M-1521-□ S
Servo Motors	40	ECMA-C1040F □ S	
		ECMA-C △ 0401 □ S	
	60	ECMA-C △ 0602 □ S	
		ECMA-C △ 0604 □ S	
		ECMA-C △ 0604 □ H	
	80	ECMA-C △ 0804 □ 7	
		ECMA-C △ 0807 □ S	
		ECMA-C △ 0807 □ H	
	86	ECMA-C △ 0907 □ S	
		ECMA-C △ 0910 □ S	
	100	ECMA-C △ 1010 □ S	
		ECMA-E △ 1305 □ S	
	130	ECMA-G △ 1303 □ S	
		ECMA-G △ 1306 □ S	
		ECMA-F △ 1308 □ S	
		ECMA-F △ 1313 □ S	
ECMA-E △ 1310 □ S			
ECMA-E △ 1315 □ S			
ECMA-G △ 1309 □ S			

Note:

- 1) The boxes (□) at the ends of ASD-M servo drives are for optional configurations. Please refer to the actual servo drive product for more model name information.
- 2) The triangles (△) in the model names of the servo motors represent encoder type. =1: Incremental encoder, 20-bit ; =A: Absolute encoder, 17-bit ; =W: Absolute encoder, 24-bit (To be provided)
- 3) The boxes (□) in the model names of the servo motors represent shaft end/brake or the number of oil seal.

# Model Name Explanation

## ASDA Series Servo Drives

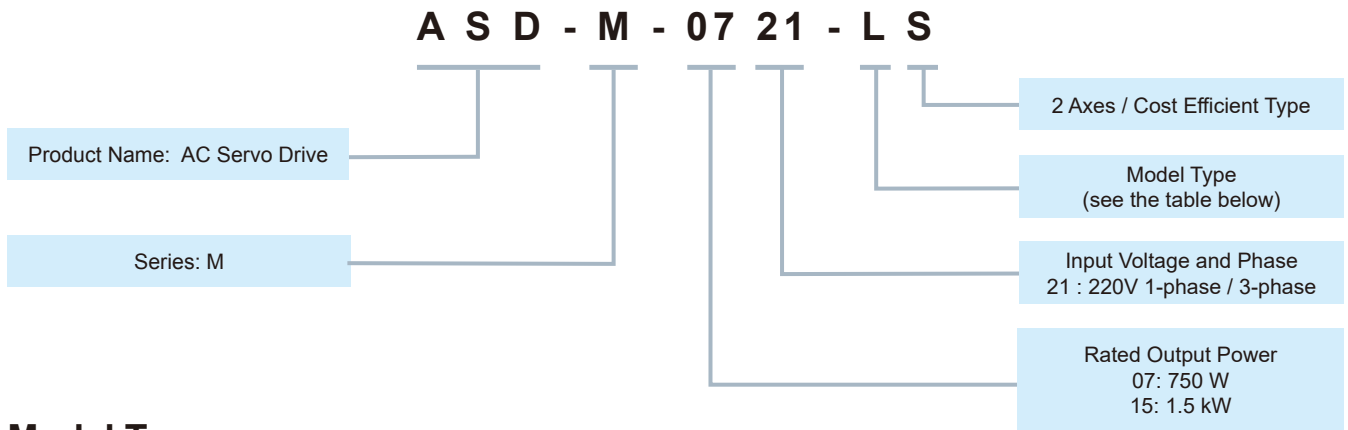

## Model Type

Type	Full-Closed Control	CANopen	DMCNET	E-CAM	Development Platform
M	○	○	X	○	X
F	○	X	○	○	X
L	○	X	X	X	X
R	○	X	○	○	○

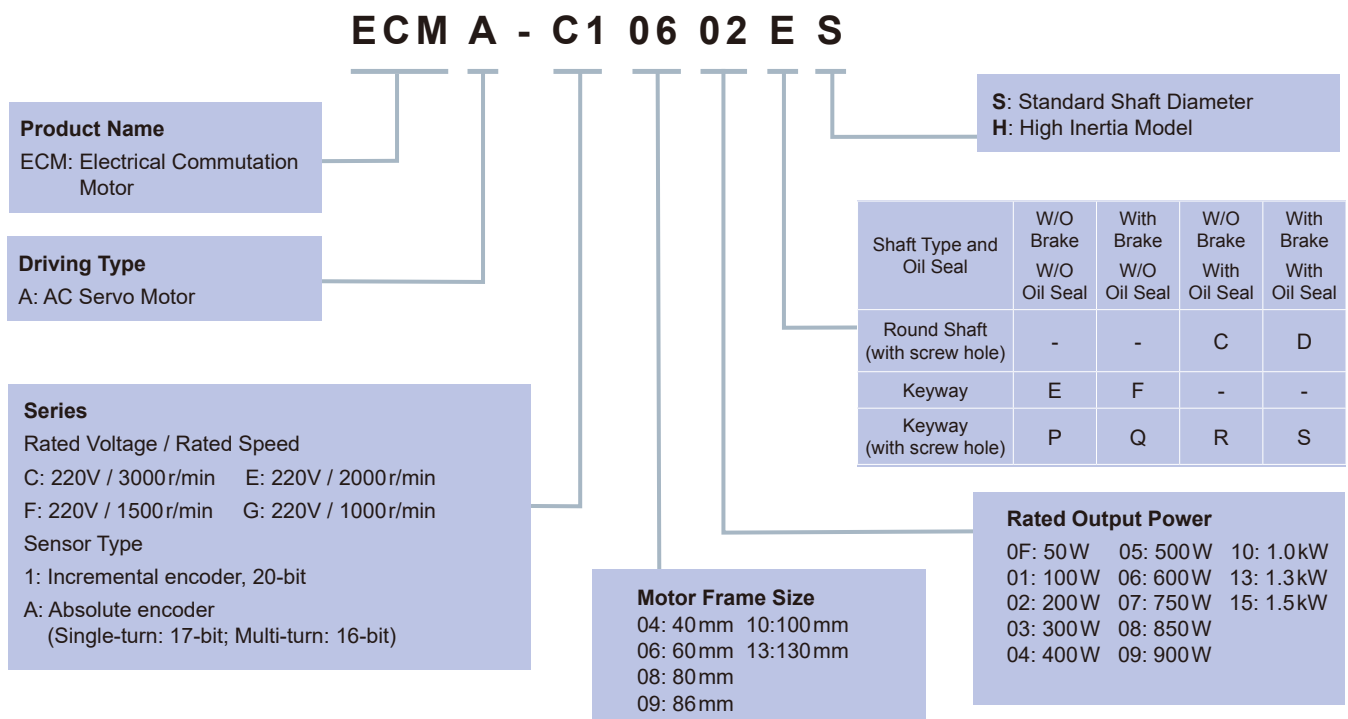

M : Supports CANopen F : Supports DMCNET L : Pure Servo R: Provides Development Platform

## ECMA Series Servo Motors



# Servo Drive Specifications

## 220V Series

ASDA-M Series		750 W		1.5 kW		
		07		15		
		0721-□	0721-□ S	1521-□	1521-□ S	
Power Supply	Phase / Voltage					
	Three-Phase or Single-Phase 220 V <sub>AC</sub>					
	Permissible Voltage Range					
	Three-Phase or Single-Phase 200~230 V <sub>AC</sub> , -15% ~ 10%					
	Input Current (3PH) (Units: Arms)	9.3	6.2	18.6	12.4	
Input Current (1PH) (Units: Arms)	17.8	11.8	33.3	22.2		
Continuous output current		5.1		8.3		
Cooling System		Fan Cooling				
Encoder Resolution / Feedback Resolution		20-bit (1280000 p/rev)				
Control of Main Circuit		SVPWM (Space Vector Pulse Width Modulation) Control				
Tuning Modes		Auto / Manual				
Regenerative Resistor		None				
Position Control Mode	Max. Input Pulse Frequency					
	Max. 500 Kpps / 4 Mpps (Line driver) Max. 200 Kpps (Open collector)					
	Pulse Type					
	Pulse + Direction, A phase + B phase, CCW pulse + CW pulse					
	Command Source					
	External pulse train (Pt mode) / Internal procedures (Pr mode)					
	Smoothing Strategy					
Low-pass and P-curve filter						
Electronic Gear		Electronic gear N/M multiple N: 1~32767, M: 1:32767 (1/50<N/M<25600)				
Torque Limit Operation		Set by parameters				
Feed Forward Compensation		Set by parameters				
Speed Control Mode	Analog Input Command	Voltage Range	0 ~ ±10 V <sub>DC</sub>			
		Input Resistance	10 KΩ			
		Time Constant	2.2 μs			
	Speed Control Range <sup>*1</sup>		1 : 5000			
	Command Source		External analog signal / Internal parameters			
	Smoothing Strategy		Low-pass and S-curve filter			
	Torque Limit Operation		Set by parameters or via analog input			
	Frequency Response Characteristic		Maximum 1 kHz			
	Speed Accuracy <sup>*2</sup> (at rated rotation speed)		0.01% or less at 0 to 100% load fluctuation 0.01% or less at ±10% power fluctuation 0.01% or less at 0°C to 50°C ambient temperature fluctuation			
	Torque Control Mode	Analog Input Command	Voltage Range	0 ~ ±10 V <sub>DC</sub>		
Input Resistance			10 KΩ			
Time Constant			2.2 μs			
Command Source		External analog signal / Internal parameters				
Smoothing Strategy		Low-pass filter				
Speed Limit Operation		Set by parameters or via analog input				
Analog Monitor Output		Monitor signal can be set by parameters (Output voltage range: ±8V)				
Digital Inputs/Outputs	Inputs					
	Servo On, Reset, Gain switching, Pulse clear, Zero speed CLAMP, Command input reverse control, Command triggered, Speed/Torque limit enabled, Position command selection, Motor stop, Speed Position Selection, Position / Speed mode switching, Speed / Torque mode switching, Torque / Position mode switching, Pt / Pr command switching, Emergency stop, Forward / Reverse inhibit limit, Reference "Home" sensor, Forward / Reverse operation torque limit, Move to "Home", Electronic cam, Forward / Reverse JOG input, Event trigger Pr command, Electronic gear ratio (Numerator) selection and Pulse inhibit input					
Digital Inputs/Outputs	Encoder signal output (A, B, Z Line Driver and Z Open Collector)					
	Outputs					
Protective Functions		Servo ready, Servo On, At Zero speed, At Speed reached, At Positioning completed, At Torques limit, Servo alarm (Servo fault) activated, Electromagnetic brake control, Homing completed, Output overload warning, Servo warning activated, Position command overflow, Forward / Reverse software limit, Internal position command completed, Capture operation completed output, Motion control completed output, Master position of E-CAM (electronic CAM)				
Communication Interface		Overcurrent, Overvoltage, Undervoltage, Motor overheated, Regeneration error, Overload, Overspeed, Abnormal pulse control command, Excessive deviation, Encoder error, Adjustment error, Emergency stop activated, Reverse/ Forward limit switch error, Position excessive deviation of full-close control loop, Serial communication error, Input power phase loss, Serial communication time out, short circuit protection of U, V, W, and CN1, CN2, CN3 terminals				
Environment		RS-232 / RS-485 / CANopen / USB				
Installation Site		Indoor location (free from direct sunlight), no corrosive liquid and gas (far away from oil mist, flammable gas, dust)				
Altitude		Altitude 2000m or lower above sea level				
Atmospheric pressure		86 kPa ~ 106 kPa				
Operating Temperature		0°C ~ 55°C (If operating temperature is above 45°C, forced cooling will be required)				
Storage Temperature		-20°C ~ 65°C				
Humidity		0 ~ 90% RH (non-condensing)				
Vibration		20 Hz or below 9.80665 m/s <sup>2</sup> ( 1G ) · 20 ~ 50 Hz 5.88 m/s <sup>2</sup> ( 0.6G )				
IP Rating		IP20				
Power System		TN System <sup>*3</sup>				
Certifications		IEC/EN 61800-5-1 · UL 508C  				

**Footnote:**

\*1. Rated rotation speed: With a full load, speed ratio is defined as the minimum speed (the motor will not pause).

\*2. When command is rated rotation speed, the speed fluctuation rate is defined as: (Empty load rotation speed - Full load rotation speed) / Rated rotation speed

\*3. TN system: A power distribution system having one point directly earthed, the exposed conductive parts of the installation being connected to that point by a protective earth conductor.

# Servo Drive Dimensions

ASD-M-0721-□ / ASD-M-0721-□ S ( 750W )

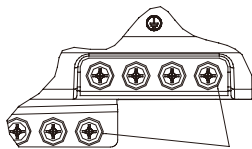
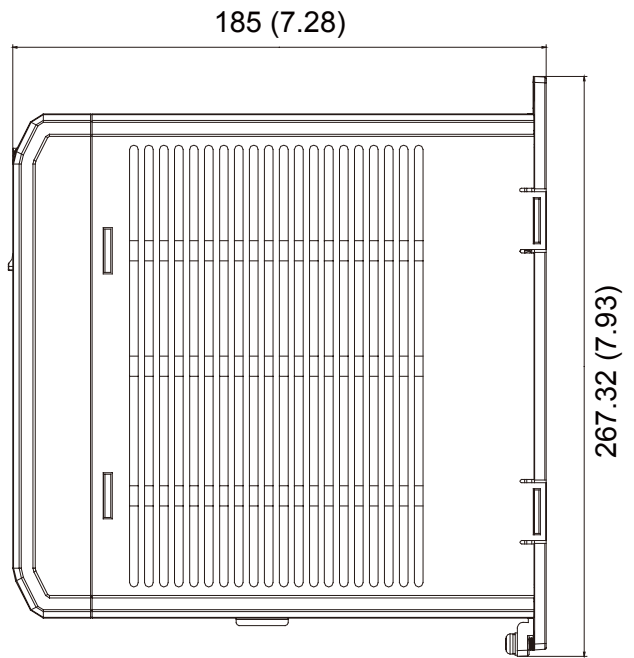
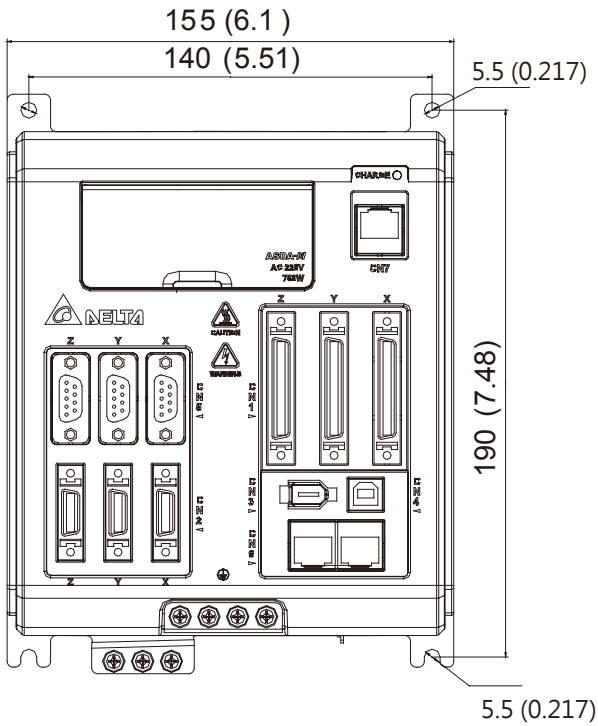

Screw: M4x0.7  
Screw Torque: 14(kgf-cm)

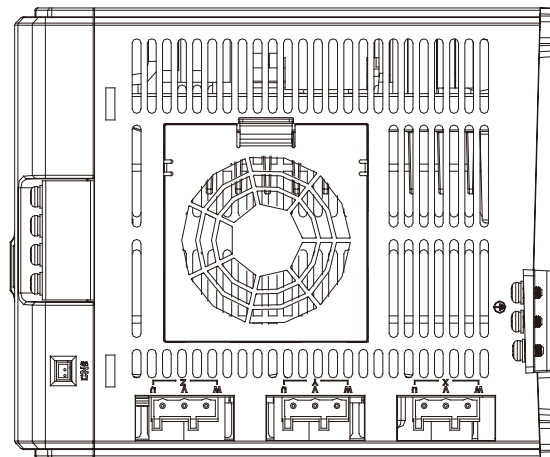

**Weight**  
3.5 (7.7)



- 1) Dimensions are in millimeters (inches); Weights are in kilograms (kg) and pounds (lbs).
- 2) Dimensions and weights of the servo drive may be revised without prior notice.

# ASD-M-1521-□ / ASD-M-1521-□ S ( 1.5kW )

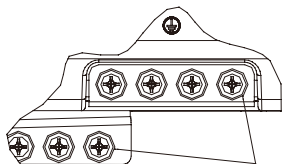
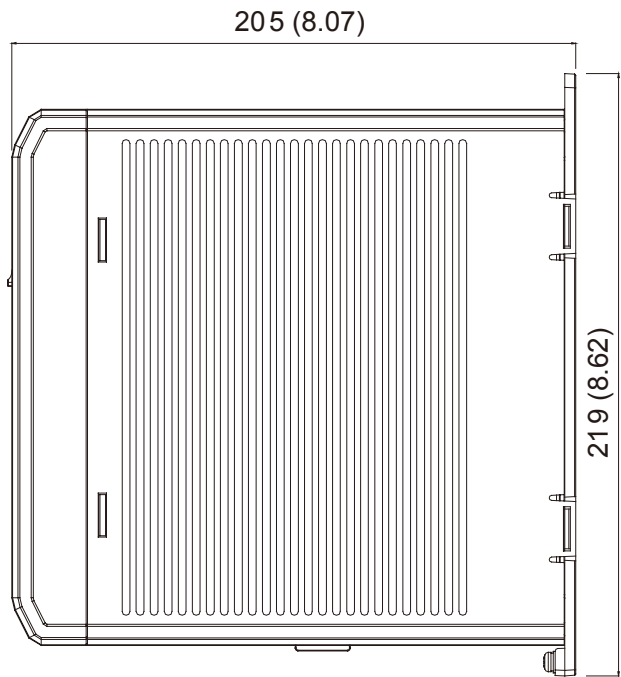
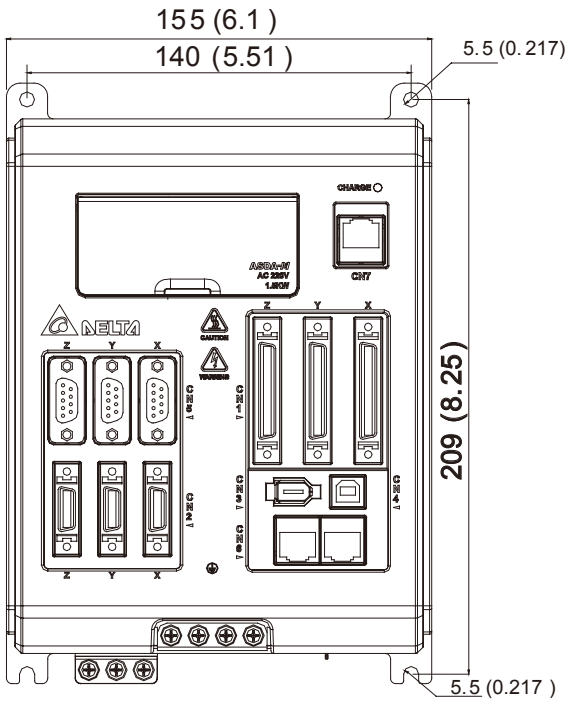

Screw: M4x0.7  
Screw Torque: 14(kgf-cm)

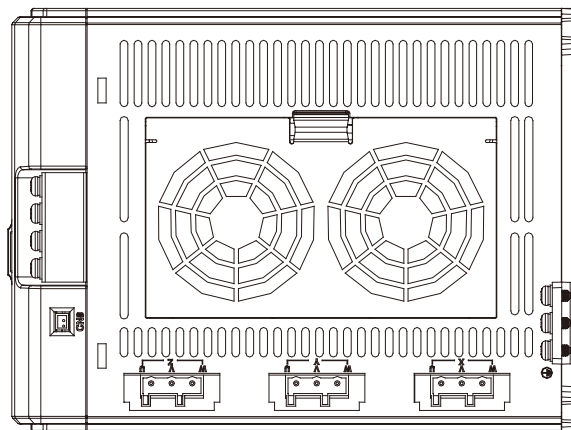

**Weight**  
4.5 (9.9)

- NOTE**
- 1) Dimensions are in millimeters (inches); Weights are in kilograms (kg) and pounds (lbs).
  - 2) Dimensions and weights of the servo drive may be revised without prior notice.





# Position (PR) Control Mode (for Internal Procedure Control)

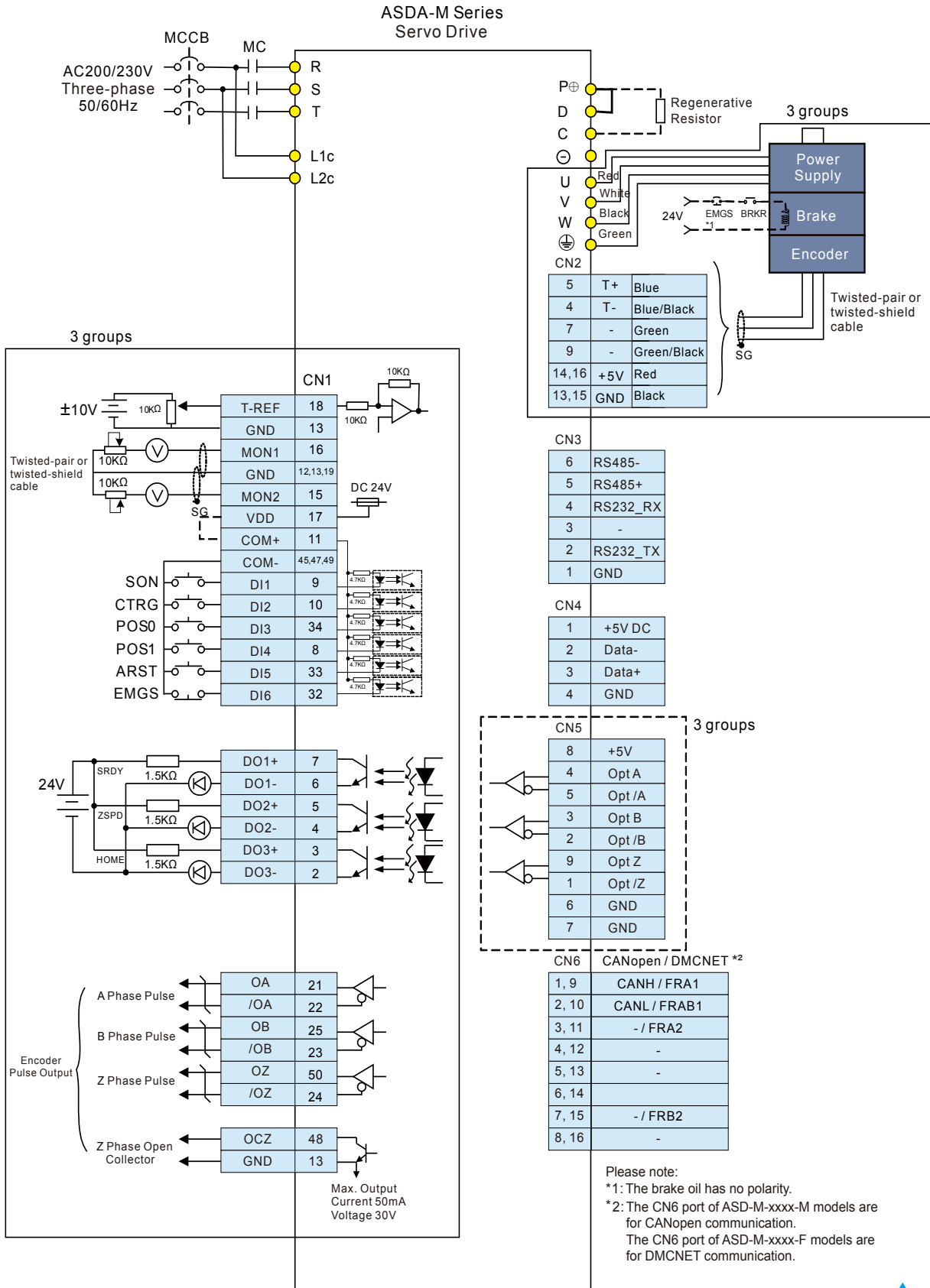

# Wiring

## Speed (S, Sz) Control Mode (for Analog Voltage Input and Internal Parameter Setting)

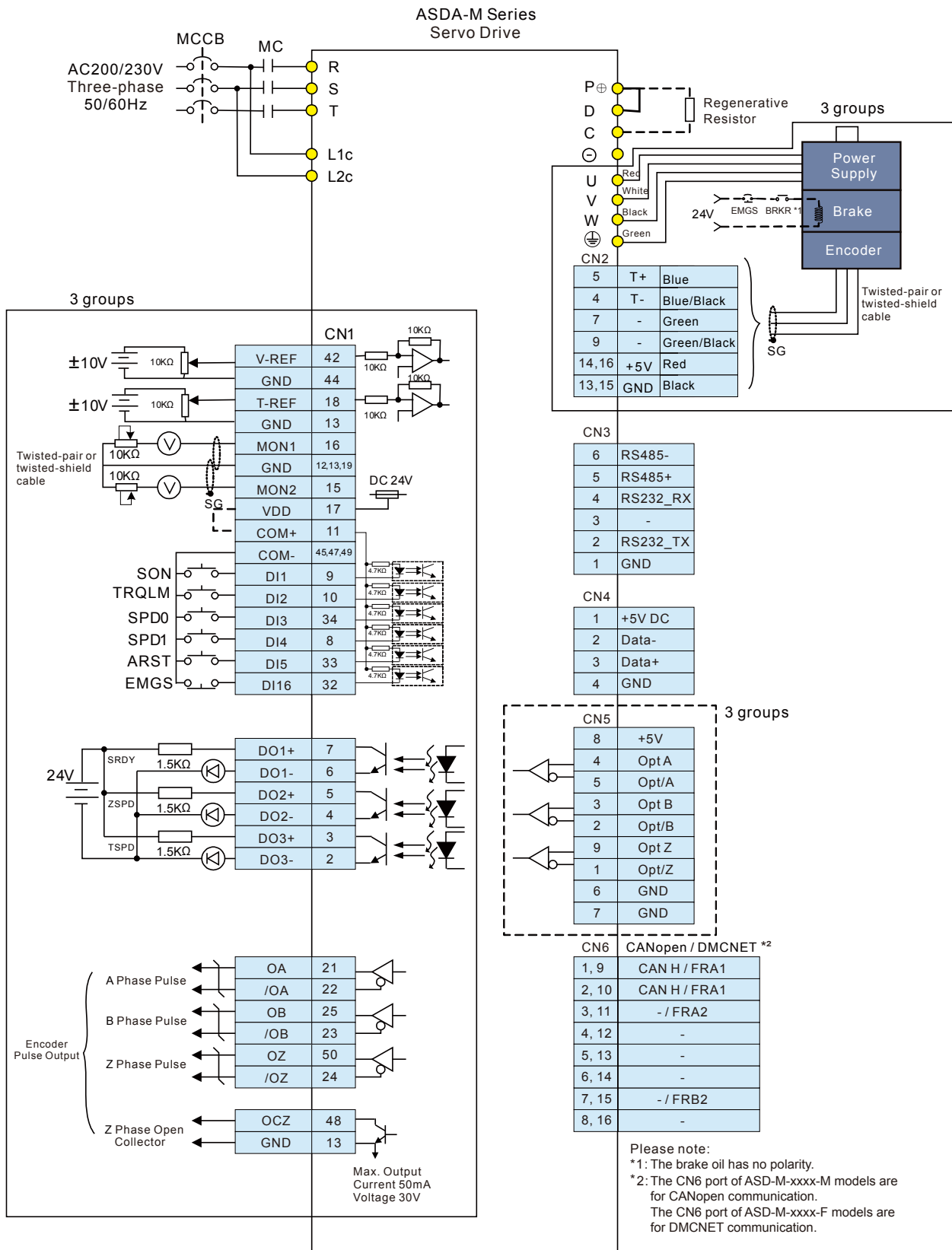

# Torque (T, Tz) Control Mode (for Analog Voltage Input and Internal Parameter Setting)

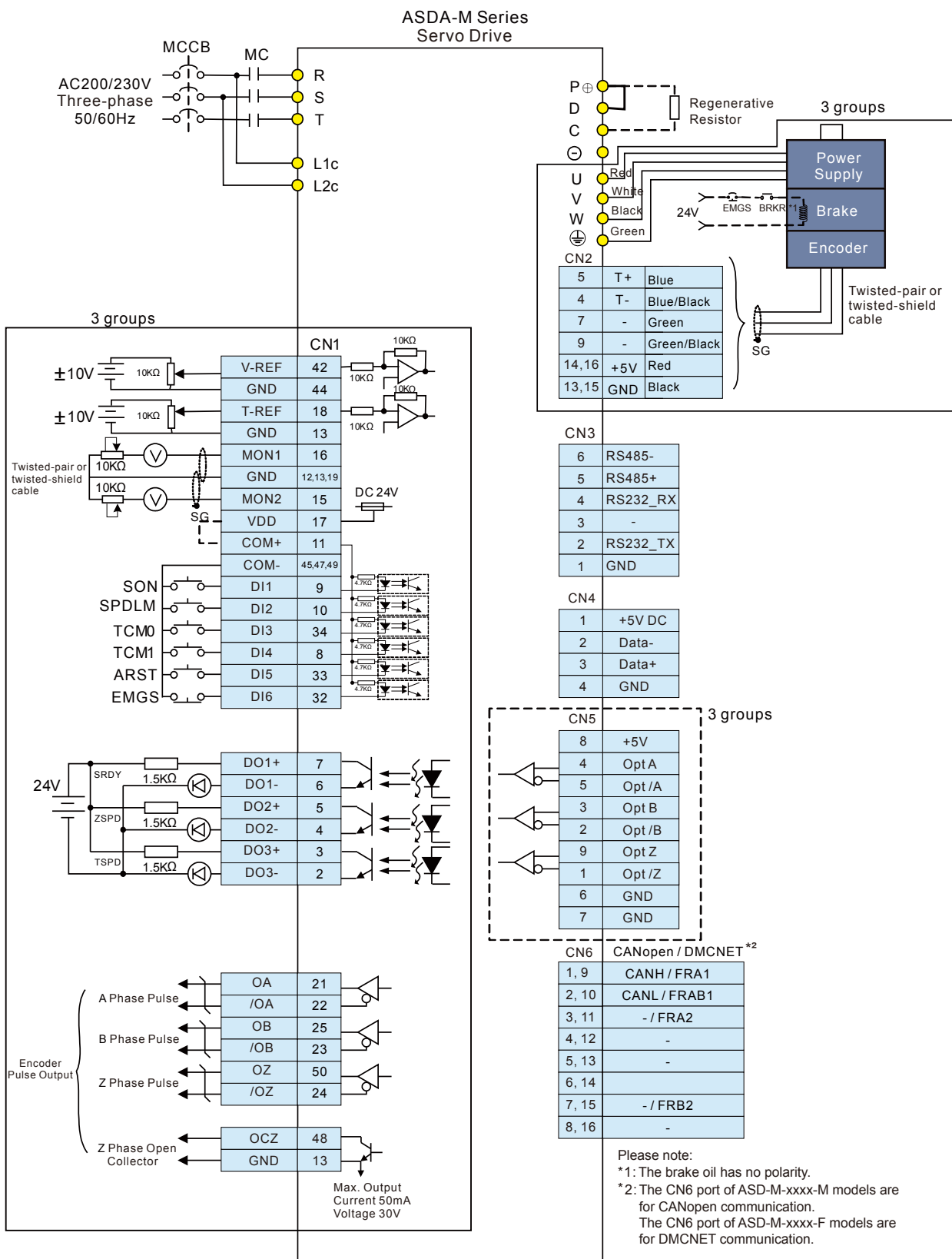

# Wiring

## CANopen / DMCNET Communication Mode ( for ASDA-M-M Series and ASDA-M-F Series )

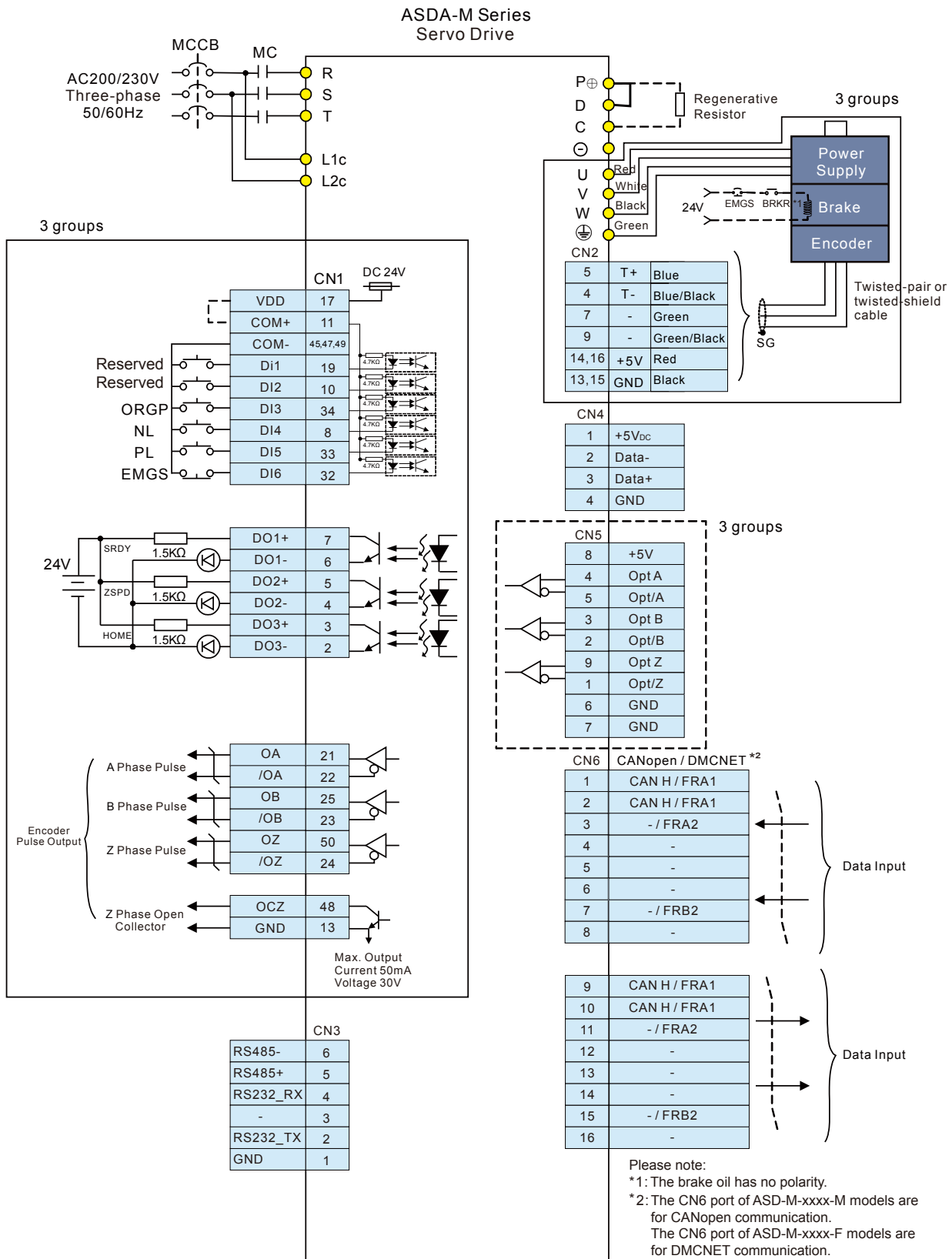

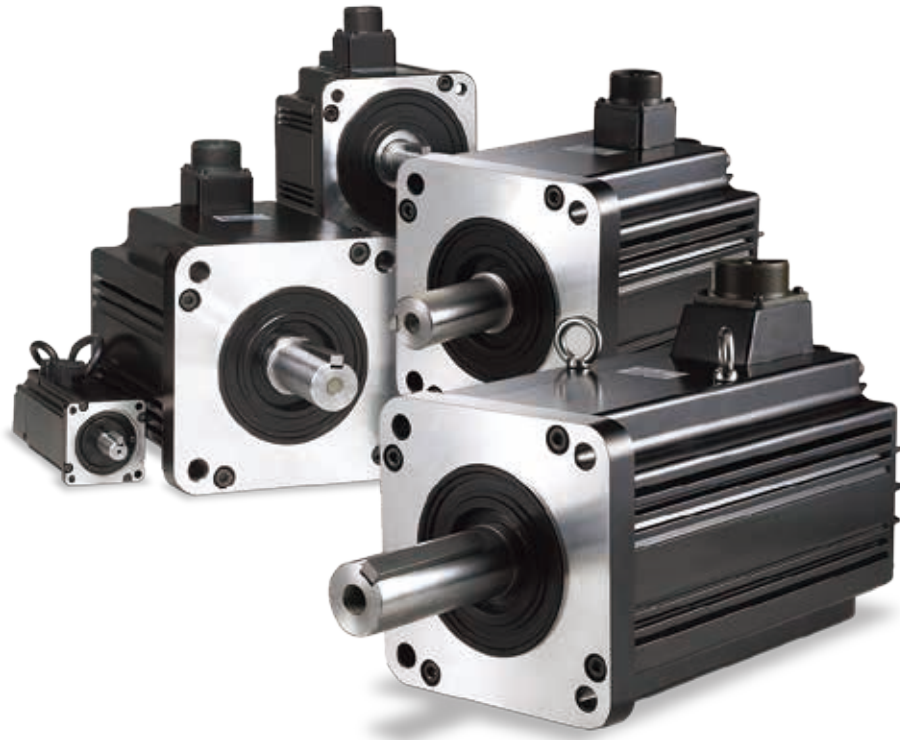



## Servo Motor Features

**ECMA** Series servo motors are permanent AC servo motors. There are six kinds of frame sizes available: 40mm, 60mm, 80mm, 86mm, 100mm and 130mm. The motor speed is up to 5000 r/min and the torque output can reach 21.48 N-m.

In terms of optional configurations, the ECMA Series provides a brake and oil seals to fully support our customers' needs. It also offers two different shaft selections, round shaft and keyway, for various applications.

# Servo Motor Specifications

## Low Inertia Series

ECMA Series	C104	C △ 04	C △ 06		C △ 08		C △ 09		C △ 10
	0F	01	02	04 □ S	04	07	07	10	10
Rated output power (kW)	0.05	0.1	0.2	0.4	0.4	0.75	0.75	1.0	1.0
Rated torque (N-m) <sup>*1</sup>	0.159	0.32	0.64	1.27	1.27	2.39	2.39	3.18	3.18
Maximum torque (N-m)	0.477	0.96	1.92	3.82	3.82	7.16	7.14	8.78	9.54
Rated speed (r/min)	3000						3000		3000
Maximum speed (r/min)	5000						3000		5000
Rated current (A)	0.69	0.90	1.55	2.6	2.6	5.1	3.66	4.25	7.3
Maximum current (A)	2.05	2.70	4.65	7.8	7.8	15.3	11	12.37	21.9
Power rating (kW/s)	12.27	27.7	22.4	57.6	24.0	50.4	29.6	38.6	38.1
Rotor moment of inertia (x10 <sup>-4</sup> kg·m <sup>2</sup> )	0.0206	0.037	0.177	0.277	0.68	1.13	1.93	2.62	2.65
Mechanical time constant (ms)	1.14	0.75	0.80	0.53	0.74	0.63	1.72	1.20	0.74
Torque constant-KT (N-m/A)	0.23	0.36	0.41	0.49	0.49	0.47	0.65	0.75	0.44
Voltage constant-KE(mV/(r/min))	9.8	13.6	16	17.4	18.5	17.2	24.2	27.5	16.8
Armature resistance (Ohm)	12.7	9.30	2.79	1.55	0.93	0.42	1.34	0.897	0.20
Armature inductance (mH)	26	24.0	12.07	6.71	7.39	3.53	7.55	5.7	1.81
Electrical time constant (ms)	2.05	2.58	4.3	4.3	7.96	8.36	5.66	6.35	9.3
Insulation class	Class A (UL), Class B (CE)								
Insulation resistance	100MΩ · DC 500V								
Insulation strength	1.8k V <sub>AC</sub> , 1 sec								
Weight (kg) (without brake)	0.42	0.5	1.2	1.6	2.1	3.0	2.9	3.8	4.3
Weight (kg) (with brake)	--	0.8	1.5	2.0	2.9	3.8	3.69	5.5	4.7
Max. radial shaft load (N)	78.4	78.4	196	196	245	245	245	245	490
Max. thrust shaft load (N)	39.2	39.2	68	68	98	98	98	98	98
Power rating (kW/s) (with brake)	--	25.6	21.3	53.8	22.1	48.4	29.3	37.9	30.4
Rotor moment of inertia (Kg.m <sup>2</sup> ) (with brake)	--	0.04	0.19	0.30	0.73	1.18	1.95	2.67	3.33
Mechanical time constant (ms) (with brake)	--	0.81	0.85	0.57	0.78	0.65	1.74	1.22	0.93
Brake holding torque [Nt·m (min)]	--	0.3	1.3	1.3	2.5	2.5	2.5	2.5	8
Brake power consumption (at 20°C) [W]	--	7.3	6.5	6.5	8.2	8.2	8.2	8.2	18.7
Brake release time [ms (Max)]	--	5	10	10	10	10	10	10	10
Brake pull-in time [ms (Max)]	--	25	70	70	70	70	70	70	70
Vibration grade ( μm )	15								
Operating temperature ( °C)	0°C to 40°C								
Storage temperature ( °C)	-10°C to 80°C								
Operating humidity	20 to 90%RH (non-condensing)								
Storage humidity	20 to 90%RH (non-condensing)								
Vibration capacity	2.5G								
IP Rating	IP65 (when waterproof connectors are used, or when an oil seal is fitted to the rotating shaft (an oil seal model is used))								
Certifications	IEC/EN 61800-5-1 · UL 508C  								

Footnote:

\*1. Rate torque values are continuous permissible values at 0~ 40°C ambient temperature when attaching with the sizes of heatsinks listed below:

ECMA-\_\_ 04 / 06 / 08 : 250mm x 250mm x 6mm



ECMA-\_\_ 10 : 300mm x 300mm x 12mm

ECMA-\_\_ 13 : 400mm x 400mm x 20mm

Material type : Aluminum F40, F60, F80, F100, F130

\*2. The holding brake is used to hold the motor shaft, not for braking the rotation. Never use it for decelerating or stopping the machine.

## Medium / Medium-High / High Inertia Series - 220V Series

ECMA Series	E $\Delta$ 13			G $\Delta$ 13			F $\Delta$ 13	C $\Delta$ 06	C $\Delta$ 08
	05	10	15	03	06	09	08	04 $\square$ H	07 $\square$ H
Rated output power (kW)	0.5	1.0	1.5	0.3	0.6	0.9	0.85	0.4	0.75
Rated torque (N-m) <sup>1</sup>	2.39	4.77	7.16	2.86	5.73	8.59	5.41	1.27	2.39
Maximum torque (N-m)	7.16	14.3	21.48	8.59	17.19	21.48	13.8	3.82	7.16
Rated speed (r/min)	2000			1000			1500	3000	3000
Maximum speed (r/min)	3000			2000			3000	5000	5000
Rated current (A)	2.9	5.6	8.3	2.5	4.8	7.5	7.1	2.6	5.1
Maximum current (A)	8.7	16.8	24.9	7.5	14.4	22.5	19.4	7.8	15.3
Power rating (kW/s)	7.0	27.1	45.9	10.0	39.0	66.0	21.52	21.7	19.63
Rotor moment of inertia (x10-4kg-m <sup>2</sup> )	8.17	8.41	11.18	8.17	8.41	11.18	13.6	0.743	2.91
Mechanical time constant (ms)	1.91	1.51	1.10	1.84	1.40	1.06	2.43	1.42	1.6
Torque constant-KT (N-m/A)	0.83	0.85	0.87	1.15	1.19	1.15	0.76	0.49	0.47
Voltage constant-KE(mV/(r/min))	30.9	31.9	31.8	42.5	43.8	41.6	29.2	17.4	17.2
Armature resistance (Ohm)	0.57	0.47	0.26	1.06	0.82	0.43	0.38	1.55	0.42
Armature inductance (mH)	7.39	5.99	4.01	14.29	11.12	6.97	4.77	6.71	3.53
Electrical time constant (ms)	12.96	12.88	15.31	13.55	13.50	16.06	12.55	4.3	8.36
Insulation class	Class A (UL), Class B (CE)								
Insulation resistance	100M $\Omega$ · DC 500V								
Insulation strength	1.8k V <sub>AC</sub> , 1 sec								
Weight (kg) (without brake)	6.8	7.0	7.5	6.8	7.0	7.5	8.6	1.8	3.4
Weight (kg) (with brake)	8.2	8.4	8.9	8.2	8.4	8.9	10.0	2.2	3.9
Max. radial shaft load (N)	490	490	490	490	490	490	490	196	245
Max. thrust shaft load (N)	98	98	98	98	98	98	98	68	98
Power rating (kW/s) (with brake)	6.4	24.9	43.1	9.2	35.9	62.1	19.78	21.48	19.3
Rotor moment of inertia (Kg.m <sup>2</sup> ) (with brake)	8.94	9.14	11.90	8.94	9.14	11.9	14.8	0.751	2.96
Mechanical time constant (ms) (with brake)	2.07	1.64	1.19	2.0	1.51	1.13	2.65	1.43	1.62
Brake holding torque [Nt-m (min)]	10.0	10.0	10.0	10.0	10.0	10.0	10.0	1.3	1.3
Brake power consumption (at 20°C) [W]	19.0	19.0	19.0	19.0	19.0	19.0	19.0	6.5	6.5
Brake release time [ms (Max)]	10	10	10	10	10	10	10	10	10
Brake pull-in time [ms (Max)]	70	70	70	70	70	70	70	70	70
Vibration grade ( $\mu$ m )	15								
Operating temperature ( °C)	0°C to 40°C (32°F to 104°F)								
Storage temperature ( °C)	-10°C to 80°C (-14°F to 176°F)								
Operating humidity	20 to 90%RH (non-condensing)								
Storage humidity	20 to 90%RH (non-condensing)								
Vibration capacity	2.5G								
IP Rating	IP65 (when waterproof connectors are used, or when an oil seal is fitted to the rotating shaft (an oil seal model is used))								
Certifications	IEC/EN 61800-5-1 · UL 508C  								

Footnote:

\*1. Rated torque values are continuous permissible values at 0 ~ 40°C ambient temperature when attaching with the sizes of heatsinks listed below:

ECMA-\_\_ 04 / 06 / 08 : 250mm x 250mm x 6mm

ECMA-\_\_ 10 : 300mm x 300mm x 12mm

ECMA-\_\_ 13 : 400mm x 400mm x 20mm

Material type : Aluminum F40, F60, F80, F100, F130

\*2. The holding brake is used to hold the motor shaft, not for braking the rotation. Never use it for decelerating or stopping the machine.

\*3. To reach the motor's max. torque limit of 250%, use the servo drive with higher watts.

# Servo Motor Dimensions

## Frame Size 86mm and below

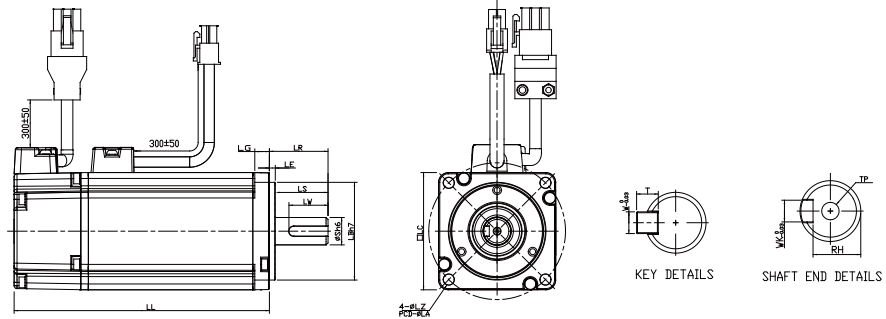

Model	C1040F □ S	C △ 0401 □ S	C △ 0602 □ S	C △ 0604 □ S	C △ 0604 □ S
LC	40	40	60	60	60
LZ	4.5	4.5	5.5	5.5	5.5
LA	46	46	70	70	70
S	8 ( $^{+0}_{-0.009}$ )	8 ( $^{+0}_{-0.009}$ )	14 ( $^{+0}_{-0.011}$ )	14 ( $^{+0}_{-0.011}$ )	14 ( $^{+0}_{-0.011}$ )
LB	30 ( $^{+0}_{-0.021}$ )	30 ( $^{+0}_{-0.021}$ )	50 ( $^{+0}_{-0.025}$ )	50 ( $^{+0}_{-0.025}$ )	50 ( $^{+0}_{-0.025}$ )
LL ( W/O Brake )	79.1	100.6	105.5	130.7	145.8
LL ( With Brake )	--	136.8	141.6	166.8	176.37
LS	20	20	27	27	27
LR	25	25	30	30	30
LE	2.5	2.5	3	3	3
LG	5	5	7.5	7.5	7.5
LW	16	16	20	20	20
RH	6.2	6.2	11	11	11
WK	3	3	5	5	5
W	3	3	5	5	5
T	3	3	5	5	5
TP	-	M3 Depth 8	M4 Depth 15	M4 Depth 15	M4 Depth 15

### NOTE

- 1) Dimensions are in millimeters.
- 2) Dimensions of the servo motors may be revised without prior notice.
- 3) The boxes ( □ ) in the model names are for optional configurations (keyway, brake and oil seal).
- 4) The triangles ( △ ) in the model names are for encoder resolution types ( △ =1: Incremental encoder, 20-bit; △ =2: Absolute encoder, 17-bit).

## Torque Curves (T-N Curves)

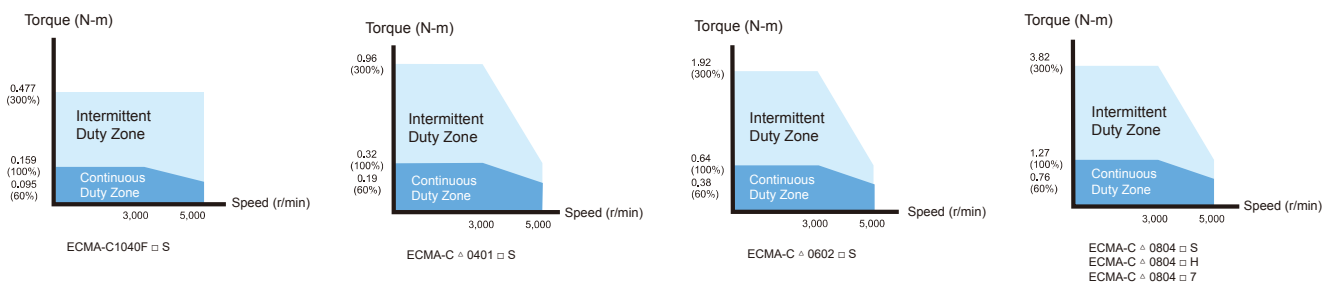



Units: mm

	C $\Delta$ 0804 $\square$ 7	C $\Delta$ 0807 $\square$ S	C $\Delta$ 0807 $\square$ H	C $\Delta$ 0907 $\square$ S	C $\Delta$ 0910 $\square$ S
	80	80	80	86	86
	6.6	6.6	6.6	6.6	6.6
	90	90	90	100	100
)	14 ( $^{+0}_{-0.011}$ )	19 ( $^{+0}_{-0.013}$ )	19 ( $^{+0}_{-0.013}$ )	16 ( $^{+0}_{-0.011}$ )	16 ( $^{+0}_{-0.011}$ )
)	70 ( $^{+0}_{-0.030}$ )	70 ( $^{+0}_{-0.030}$ )	70 ( $^{+0}_{-0.030}$ )	80 ( $^{+0}_{-0.030}$ )	80 ( $^{+0}_{-0.030}$ )
	112.3	138.3	151.1	130.2	153.2
	152.8	178	189	161.3	184.3
	27	32	32	30	30
	30	35	35	35	35
	3	3	3	3	3
	8	8	8	8	8
	20	25	25	20	20
	11	15.5	15.5	13	13
	5	6	6	5	5
	5	6	6	5	5
	5	6	6	5	5
	M4 Depth 15	M6 Depth 20	M6 Depth 20	M5 Depth 15	M5 Depth 15

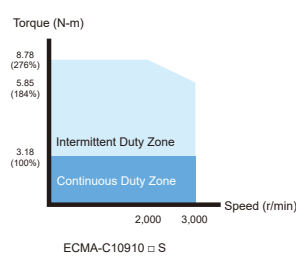
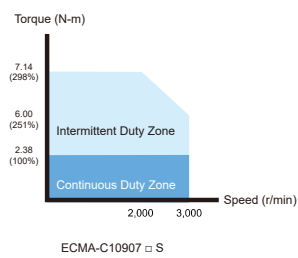
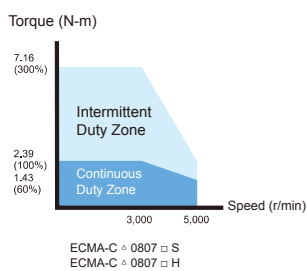

# Servo Motor Dimensions

Frame Size 100m ~ 130m

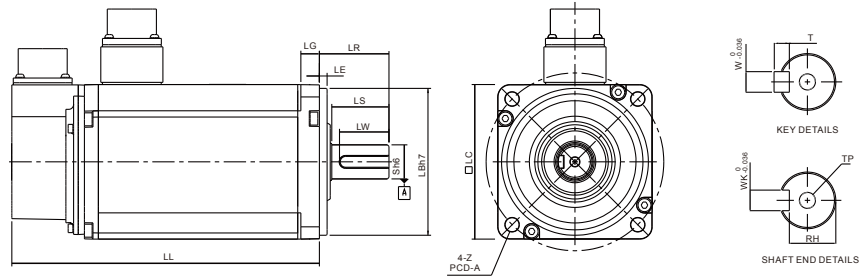

Units: mm

Model	C $\triangle$ 1010 $\square$ S	E $\triangle$ 1305 $\square$ S	E $\triangle$ 1310 $\square$ S	E $\triangle$ 1315 $\square$ S	F $\triangle$ 1308 $\square$ S	G $\triangle$ 1303 $\square$ S	G $\triangle$ 1306 $\square$ S	G $\triangle$ 1309 $\square$ S
LC	100	130	130	130	130	130	130	130
LZ	9	9	9	9	9	9	9	9
LA	115	145	145	145	145	145	145	145
S	22 ( $^{+0}_{-0.013}$ )	22 ( $^{+0}_{-0.013}$ )	22 ( $^{+0}_{-0.013}$ )	22 ( $^{+0}_{-0.013}$ )	22 ( $^{+0}_{-0.013}$ )	22 ( $^{+0}_{-0.013}$ )	22 ( $^{+0}_{-0.013}$ )	22 ( $^{+0}_{-0.013}$ )
LB	95 ( $^{+0}_{-0.035}$ )	110 ( $^{+0}_{-0.035}$ )	110 ( $^{+0}_{-0.035}$ )	110 ( $^{+0}_{-0.035}$ )	110 ( $^{+0}_{-0.035}$ )	110 ( $^{+0}_{-0.035}$ )	110 ( $^{+0}_{-0.035}$ )	110 ( $^{+0}_{-0.035}$ )
LL ( W/O Brake )	153.3	147.5	147.5	167.5	152.5	147.5	147.5	163.5
LL ( With Brake )	192.5	183.5	183.5	202	181	183.5	183.5	198
LS	37	47	47	47	47	47	47	47
LR	45	55	55	55	55	55	55	55
LE	5	6	6	6	6	6	6	6
LG	12	11.5	11.5	11.5	11.5	11.5	11.5	11.5
LW	32	36	36	36	36	36	36	36
RH	18	18	18	18	18	18	18	18
WK	8	8	8	8	8	8	8	8
W	8	8	8	8	8	8	8	8
T	7	7	7	7	7	7	7	7
TP	M6 Depth 20	M6 Depth 20	M6 Depth 20	M6 Depth 20	M6 Depth 20	M6 Depth 20	M6 Depth 20	M6 Depth 20



## NOTE

- 1) Dimensions are in millimeters.
- 2) Dimensions of the servo motors may be revised without prior notice.
- 3) The boxes ( $\square$ ) in the model names are for optional configurations (keyway, brake and oil seal).
- 4) The triangles ( $\triangle$ ) in the model names are for encoder resolution types ( $\triangle$  =1: Incremental encoder, 20-bit;  $\triangle$  =2: Absolute encoder, 17-bit).

## Torque Curves (T-N Curves)

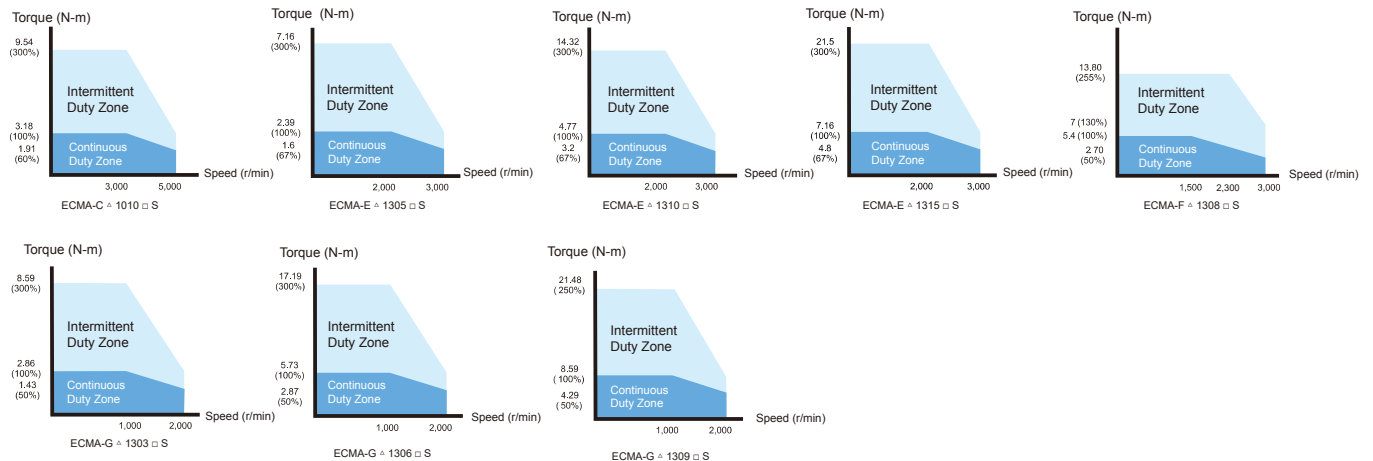

# DMCNET Remote Modules

## Digital I/O Remote Modules

- ASD-DMC-RM32MN / ASD-DMC-RM32NT
- ASD-DMC-RM64MN / ASD-DMC-RM64NT

### Electrical Specifications

Item	RM32MN / RM64MN	RM32NT / RM64NT
Circuit Type	Single	Transistor
Signal Type	SINK / SOURCE	SINK
Power Supply Voltage	24VDC (5mA)	24VDC (0.1A / 1 Point)
Response Time / Work Frequency	0 ~ 3ms (adjustable)	1KHz
Active Level (OFF → ON)	> 16.5VDC	20μs
Active Level (ON → OFF)	< 8VDC	30μs
Noise Immunity	ESD (IEC 61131-2, IEC 61000-4-2): 8KV Air Discharge EFT (IEC 61131-2, IEC 61000-4-4): Power Line: 2KV, Communication I/O: 1KV RS (IEC 61131-2, IEC 61000-4-3): 80MHz ~ 1GHz, 10V/m	
Operation / Storage Environment	Operation: 0°C ~ 50°C (32°F ~ 122°F) Storage: -20°C ~ 70°C (-4°F ~ 158°F)	

### Installation & Wiring

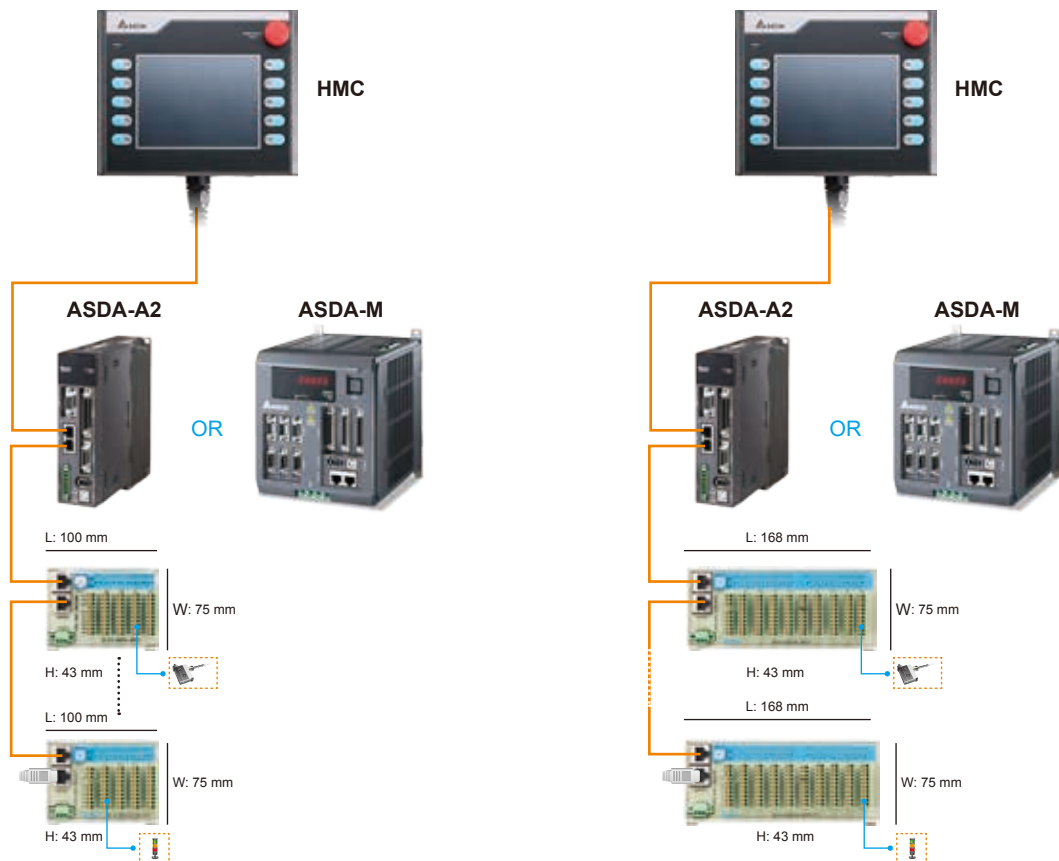

# DMCNET Remote Modules

## Pulse Remote Modules

### ■ ASD-DMC-RM04PI

#### Electrical Specifications

ASD-DMC-RM04PI		ASD-DMC-RM04PI		
Item	Input (QA,QB,QZ,DI1,DI2)	Item	Input (QA,QB,QZ,DI1,DI2)	Output (MEL,PEL,ORG,SLD)
Circuit Type	Single	Circuit Type	Single	Transistor
Signal Type	SINK	Signal Type	SINK / SOURCE	SINK
Power Supply Voltage	5VDC	Power Supply Voltage	24VDC (5mA)	5~24VDC (30mA / 1 Point)
Work Frequency	QA, QB, QZ : 200KHz (5mA / 1 Point) QA, QB,QZ: 200KHz (5mA/1 Point)	Work Frequency	1ms	CW, CCW : 200KHz DO1, DO2 : 1KHz
Noise Immunity	<ul style="list-style-type: none"> <li>ESD (IEC 61131-2, IEC 61000-4-2): 8KV Air Discharge</li> <li>EFT (IEC 61131-2, IEC 61000-4-4): Power Line: 2KV, Communication I/O: 1KV</li> <li>RS (IEC 61131-2, IEC 61000-4-3): 80MHz ~ 1GHz, 10V/m</li> </ul>	Active Level (OFF → ON)	> 16.5VDC	--
		Active Level (ON → OFF)	< 8VDC	--
Operation / Storage Environment	Operation: 0°C ~ 50°C (32°F ~ 122°F) Storage: -20°C ~ 70°C (-4°F ~ 158°F)	Noise Immunity	<ul style="list-style-type: none"> <li>ESD (IEC 61131-2, IEC 61000-4-2): 8KV Air Discharge</li> <li>EFT (IEC 61131-2, IEC 61000-4-4): Power Line: 2KV, Communication I/O: 1KV</li> <li>RS (IEC 61131-2, IEC 61000-4-3): 80MHz ~ 1GHz, 10V/m</li> </ul>	
		Operation / Storage Environment	Operation: 0°C ~ 50°C (32°F ~ 122°F) Storage: -20°C ~ 70°C (-4°F ~ 158°F)	

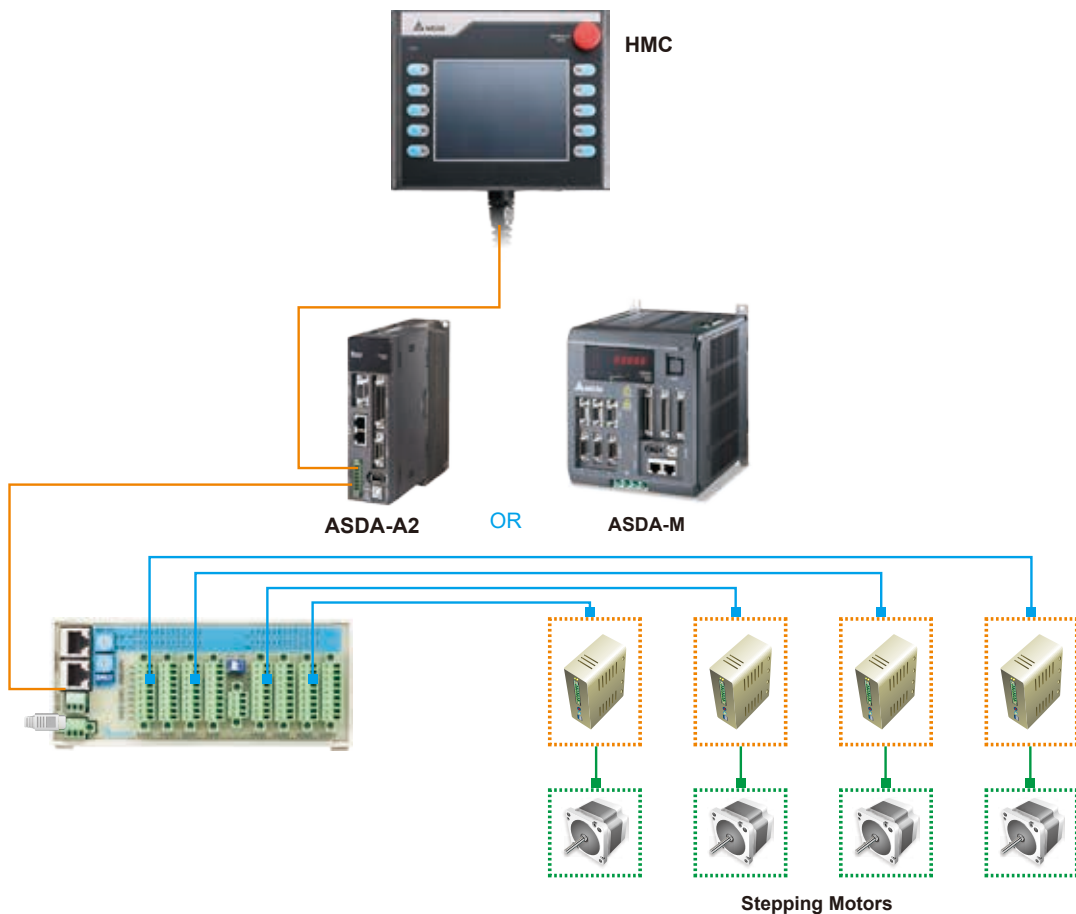

# Analog I/O Remote Modules

## ASD-DMC-RM04DA / ASD-DMC-RM04AD

### Electrical Specifications

ASD-DMC-RM04DA	
Item	Analog to Digital - Input Point (RM04AD)
Analog Output Channel	4-Channel / Module
Range of Analog Voltage Output	-10 ~ 10V ; -5 ~ 5V ; 0 ~ 10V ; 0 ~ 5V
Range of Analog Current Output	0 ~ 24mA ; 0 ~ 20mA ; 4 ~ 20mA
Over Range of Analog Output	10%
Max. Output Current	20mA
Allowable Load Impedance	0 ~ 500Ω
Range of Digital Data	0 ~ 4096
Resolution	16 bits
DC Output Impedance	0.3Ω
Response Time	1ms
Digital Data Format	16bits
Isolation	Internal circuit and analog output terminals are isolated by optical coupler.
Protection	Voltage output is protected by a circuit breaker. But, a short circuit lasting for too long may cause damage to internal circuits. Current output can be open circuit.
Noise Immunity	<ul style="list-style-type: none"> <li>ESD (IEC 61131-2, IEC 61000-4-2): 8KV Air Discharge</li> <li>EFT (IEC 61131-2, IEC 61000-4-4): Power Line: 2KV,</li> <li>Communication I/O: 1KV</li> <li>RS (IEC 61131-2, IEC 61000-4-3): 80MHz ~ 1GHz, 10V/m</li> </ul>
Operation / Storage Environment	Operation: 0°C ~ 50°C (32°F ~ 122°F) Storage: -20°C ~ 70°C (-4°F ~ 158°F)

ASD-DMC-RM04AD	
Item	Analog to Digital - Input Point (RM04AD)
Analog Output Channel	4-Channel / Module
Range of Analog Voltage Output	-10 ~ 10V ; -5 ~ 5V ; 0 ~ 10V ; 0 ~ 5V
Range of Analog Current Output	0 ~ 24mA
Range of Digital Data	0 ~ 65535
Resolution	16 bits
Voltage Input Impedance	140Ω
Current Input Impedance	249Ω
Overall Accuracy	±0.5% when in full scale (25°C, 77°F) ±1% when in full scale within the range of 0°C ~ 55°C, 32°F ~ 131°F
Response Time	Min. 1ms. Max. 3ms × the number of channels
Isolation	Internal circuit and analog output terminals are isolated by optical coupler.
Range of Absolute Voltage Input	-15 ~ 15 V
Range of Absolute Current Input	32mA
Digital Data Format	16bits
Noise Immunity	<ul style="list-style-type: none"> <li>ESD (IEC 61131-2, IEC 61000-4-2): 8KV Air Discharge</li> <li>EFT (IEC 61131-2, IEC 61000-4-4): Power Line: 2KV,</li> <li>Communication I/O: 1KV</li> <li>RS (IEC 61131-2, IEC 61000-4-3): 80MHz ~ 1GHz, 10V/m</li> </ul>
Operation / Storage Environment	Operation: 0°C ~ 50°C (32°F ~ 122°F) Storage: -20°C ~ 70°C (-4°F ~ 158°F)

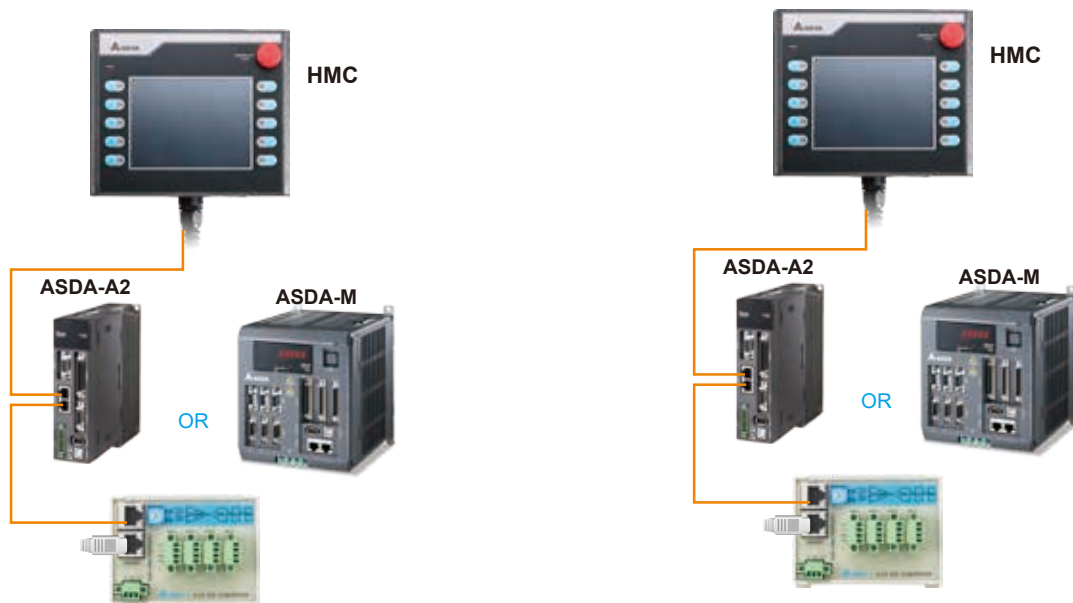

# Part Names and Functions

## ● LED Display / Operation Panel

- **LED Display**  
The 5 digit, 7 segment LED displays the servo status or fault codes
- **Operation Panel**  
Function keys used to perform status display, monitor and diagnostic, function and parameter setting.
- **Function Keys:**  
MODE: Press this key to select/change mode  
SHIFT: Press this key to shift cursor to the left  
UP: Press this key to increase values on the display  
DOWN: Press this key to decrease values on the display  
SET: Press this key to store data

## ● Charge LED

- A lit LED indicates that either power is connected to the servo drive or a residual charge is present in the drive's internal power components.

## ● I/O Interface

- Used to connect Delta's DVP Series PLC or other external controllers for controlling I/O signals.

## ● Full-Closed Loop Control Interface

- Used to connect linear scale and encoder for controlling A, B, Z phase signals for inputs of X, Y, Z axes.

## ● Motor Encoder Interface

- Used to connect the encoder of the servo motor and feedback the signals to X, Y, Z axes of the servo drive.

## ● Serial Communication Port

- Used to connect PLC, HMI, and other controllers for RS-485 / RS-232 serial communication.

## ● Ground Terminal

- Used to connect grounding wire of power supply and servo motor.

## ● High-speed Communication Port

- Used to connect CANopen networks.
- DMCNE Tinterface, supporting motion modes for CANopen DS402 implementation.
- CANbus interface, supporting motion modes for CANopen DS402 implementation.

## ● USB Connection Port

Ver 1.1 USB is equipped as standard.

- Direct connectivity to personal computers or notebooks, capable of accessing data through ASDA-Soft configuration software.
- Remote monitoring speed via ASDA-Soft configuration software is up to 1 Mbps.





### ● Control Circuit Terminal / Main Circuit Terminal / Internal & External Regenerative Resistor Terminal

- Control Circuit Terminal (L1c, L2c) L1c, L2c are used to connect 200~230Vac, 50/60Hz single-phase or three-phase power supply.
- Main Circuit Terminal (R, S, T) Used to connect 200~230Vac, 50/60Hz commercial power supply.
- When using an external braking unit, connect it to P $\oplus$  and  $\ominus$ .
- Internal & External Regenerative Resistor Terminal
  1. When using an external resistor, connect it to P $\oplus$  and C, and ensure an open circuit between P $\oplus$  and D.
  2. When using an internal resistor, ensure the circuit is closed between P $\oplus$  and D, and the circuit is open between P $\oplus$  and C. (Note: Please refer to the table of regenerative resistor specifications for the models with a built-in regenerative resistor.)
  3. When using an external braking unit, connect it to P $\oplus$  and  $\ominus$ , and ensure an open circuit between P $\oplus$  and D, and P $\oplus$  and C.

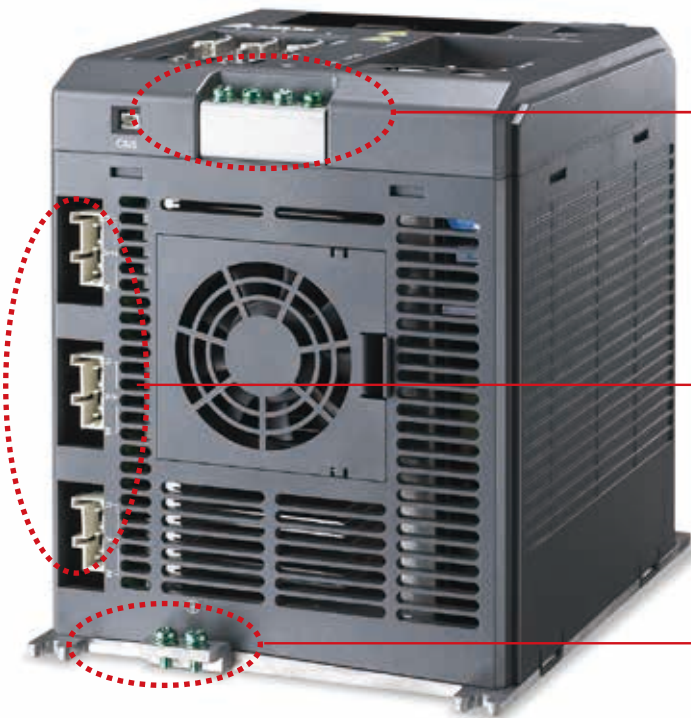

### ● Ground Terminal

- Used to connect grounding wire of power supply and servo motor.

### ● Servo Motor Output (U, V, W)

- Used to connect servo motor. Never connect the output terminal to main circuit power as the AC drive may be damaged beyond repair if incorrect cables are connected to the output terminals.

### ● Ground Terminal

- Used to connect grounding wire of power supply and servo motor.



#### NOTE

The figures are for illustration purposes only. Actual models may differ slightly in appearance from illustrations provided.

# Optional Accessories

## ● Quick Connectors

- Used for 750W to 1.5kW servo drives
- One operating lever is provided for wire to terminal block insertion.



## ● Power Cables

- 3m and 5m standard cables are available.
- Customized service is offered to meet the needs of customers.
- Two types are selectable: with brake and without brake.

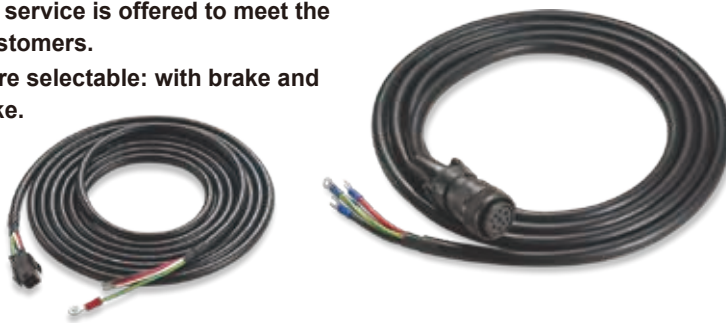

## ● Encoder Cables

- 3m and 5m standard cables are available.
- Customized service is offered to meet the needs of customers.



## ● RS-232 Communication Cables

- Connects ASDA-M to PLC, HMI, and other controllers via RS-232 communication.
- Standard cable length is 3m.
- Delta Part Number: ASD-CARS0003







### ● Terminal Block Modules

- Easy installation and wiring 0.5m connection cable is provided.
- Easy to reduce the space required.
- Easy to expand system's I/O configuration.
- Delta Part Number: ASD-BM-50A



### ● Regenerative Resistors

- For selecting a regenerative resistor, please refer to the table of regenerative resistor specifications on page 50.



### ● USB Communication Cables (for PC)

- Connects ASDA-A2 to a PC (via ASDA-Soft configuration software)
- USB1.1 is equipped as standard.
- Delta Part Number: DOP-CAUSBAB

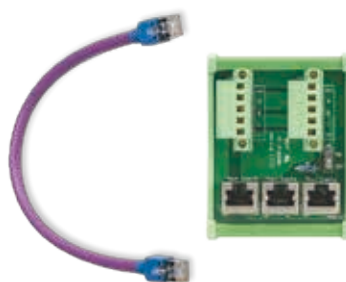

### ● CANopen Accessories

- Delta's TAP-CN03 distribution box connects ASDA-A2 to Delta's PLC CAN Master.
- For selecting CANopen accessories, please refer to the table of other accessories on page 49.



### ● RS-485 Connectors

- Used to connect multiple ASDA-M systems by RS-485 interface through Modbus serial communication.
- Delta Part Number: ASD-CNIE0B06



**NOTE**

The figures are for illustration purposes only. Actual models may differ slightly in appearance from illustrations provided.

# Optional Cables and Connectors

## Power Connectors

**ASDBCAPW0000**

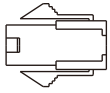

**ASDBCAPW0100**

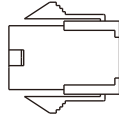

**ASD-CAPW1000**

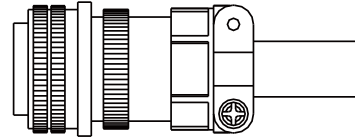

3106A-20-18S

## Power Cables

**ASD-ABPW0003, ASD-ABPW0005**

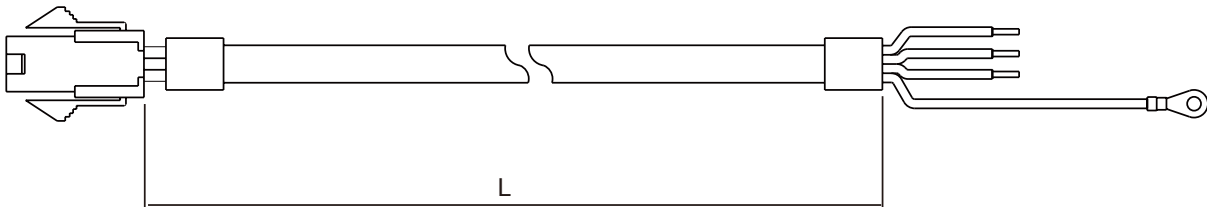

Item	Part No.	L	
		mm	inch
1	ASD-ABPW0003	3000 ± 100	118 ± 4
2	ASD-ABPW0005	5000 ± 100	197 ± 4

**ASD-ABPW0103, ASD-ABPW0105**

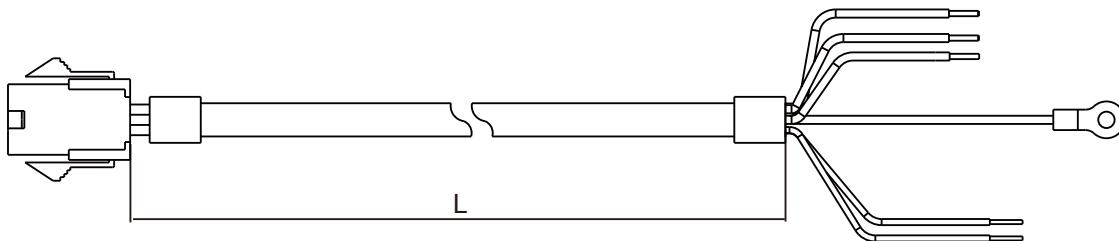

Item	Part No.	L	
		mm	inch
1	ASD-ABPW0103	3000 ± 100	118 ± 4
2	ASD-ABPW0105	5000 ± 100	197 ± 4

## Power Cables

### ASD-CAPW1003, ASD-CAPW1005

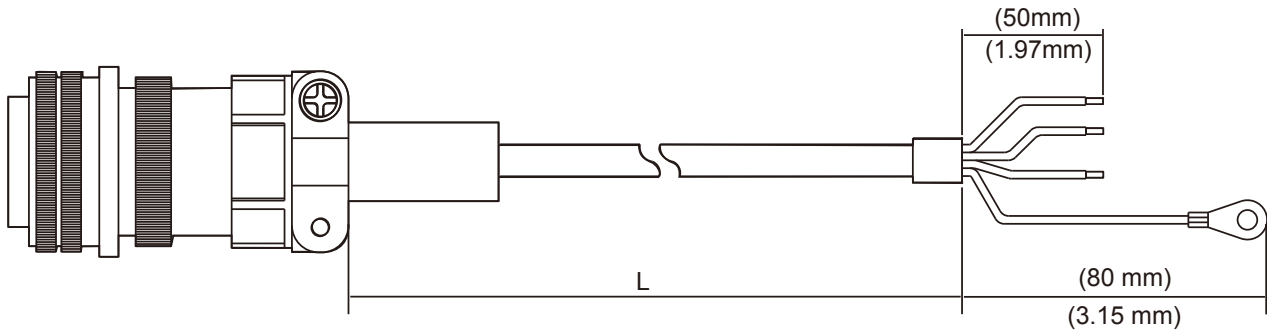

Item	Part No.	Straight	L	
			mm	inch
1	ASD-CAPW1003	3106A-20-18S	3000 ± 100	118 ± 4
2	ASD-CAPW1005	3106A-20-18S	5000 ± 100	197 ± 4

### ASD-CAPW1103, ASD-CAPW1105

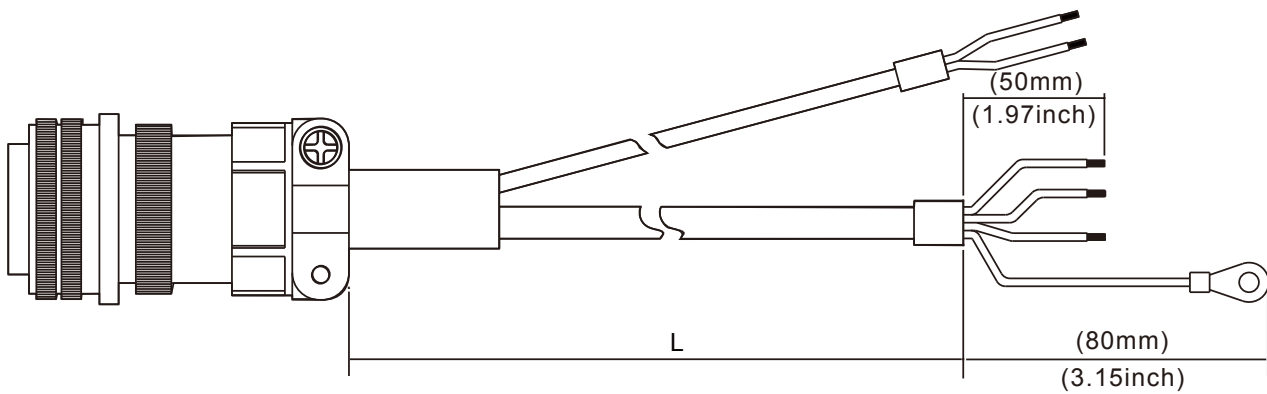

Item	Part No.	Straight	L	
			mm	inch
1	ASD-CAPW1103	3106A-20-18S	3000 ± 100	118 ± 4
2	ASD-CAPW1105	3106A-20-18S	5000 ± 100	197 ± 4

# Optional Cables and Connectors

## Encoder Connectors

### ASD-ABEN0000

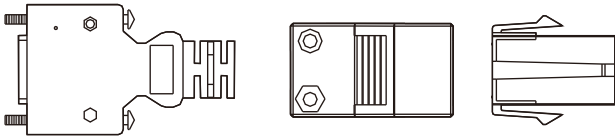

### ASD-CAEN1000

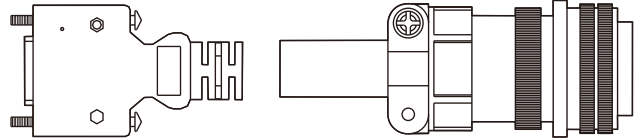

## Encoder Cables

### ASD-ABEN0003, ASD-ABEN0005

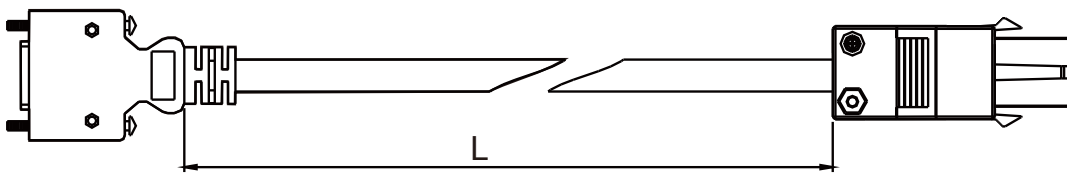

Item	Part No.	L	
		mm	inch
1	ASD-ABEN0003	3000 ± 100	118 ± 4
2	ASD-ABEN0005	5000 ± 100	197 ± 4

### ASD-CAEN1003, ASD-CAEN1005

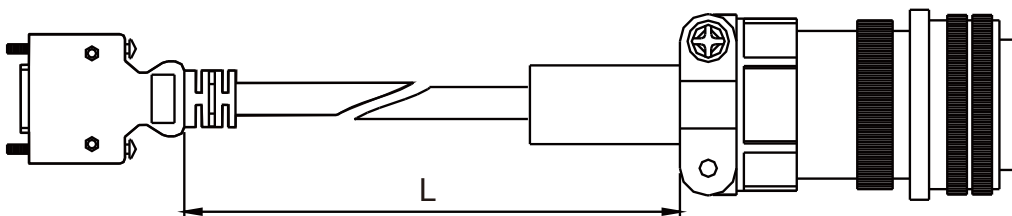

Item	Part No.	Straight	L	
			mm	inch
1	ASD-CAEN1003	3106A-20-29S	3000 ± 100	118 ± 4
2	ASD-CAEN1005	3106A-20-29S	5000 ± 100	197 ± 4

# Optional Cables and Connectors

## I/O Signal Connector

ASD-CN5C0050

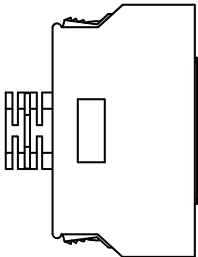

## Terminal Block Module

ASD-BM-50A

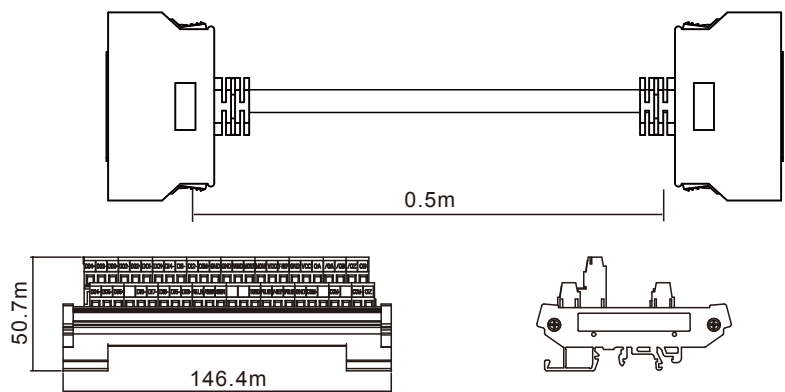
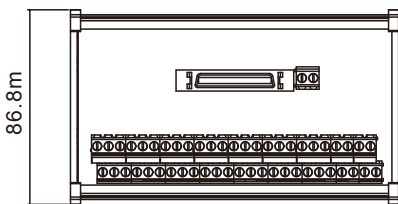

## RS-232 Communication Cable

ASD-CARS0003

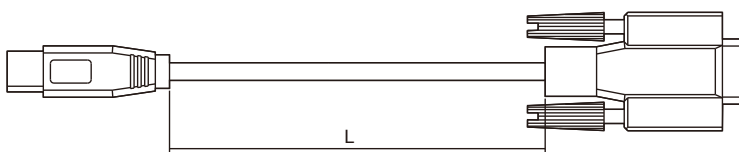

Item	Part No.	L	
		mm	inch
1	ASD-CARS0003	3000 ± 100	118 ± 4

## Communication Cable between Drive and Computer (for PC)

DOP-CAUSBAB

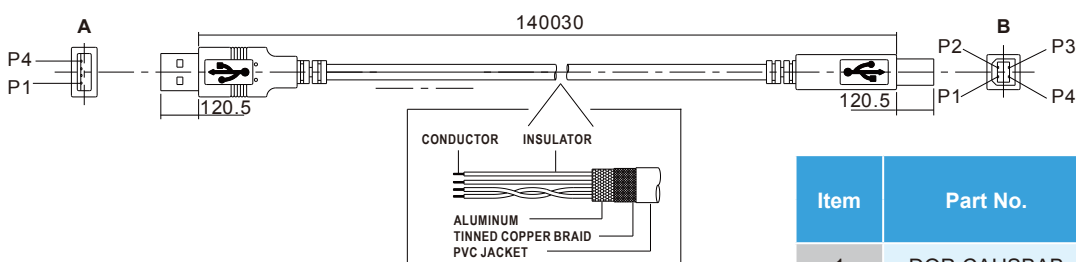

Item	Part No.	L	
		mm	inch
1	DOP-CAUSBAB	1400 ± 30	55 ± 1.2

## CANopen Communication Cable

### TAP-CB03, TAP-CB05

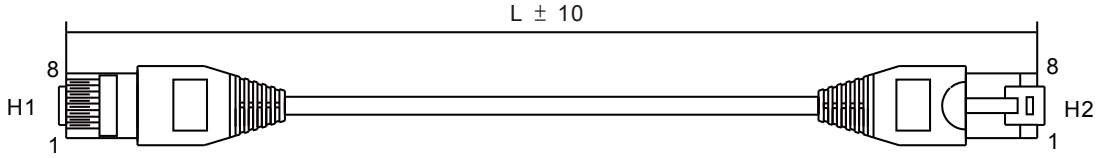

Item	Part No.	L	
		mm	inch
1	TAP-CB03	$300 \pm 10$	$11 \pm 0.4$
2	TAP-CB05	$500 \pm 10$	$19 \pm 0.4$

## CANopen Distribution Box

### TAP-CN03

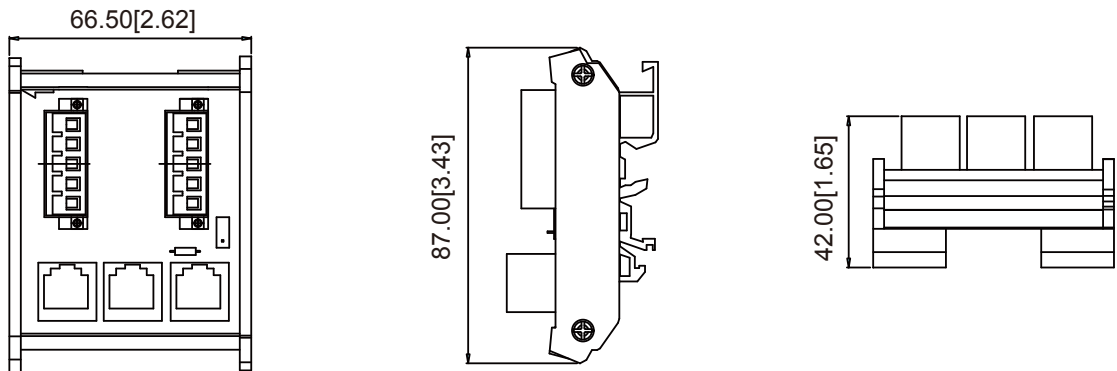

## RS-485 Connector

### ASD-CNIE0B06

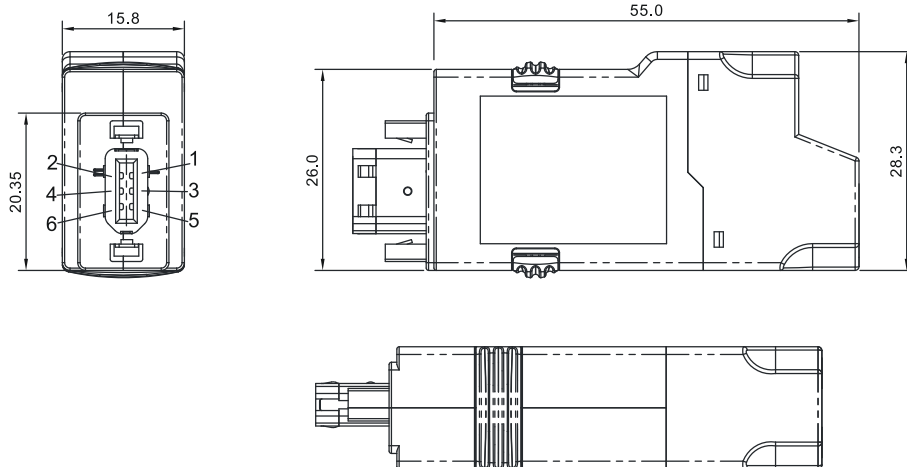

#### NOTE

Accessories images shown here may differ from actual product appearance. Please refer to the actual product appearance.

## Accessories Combinations

### 750W Servo Drive and 50W Low Inertia Servo Motor

Servo Drive	ASD-M-0721-□
Low Inertia Servo Motor	ECMA-C1040F □ S
Power Cable (Without Brake)	ASD-ABPW000X
Power Connector (Without Brake)	ASDBCAPW0000
Power Cable (With Brake)	ASD-ABPW010X
Power Connector (With Brake)	ASDBCAPW0100
Incremental Encoder Cable	ASD-ABEN000X
Absolute Encoder Cable	ASD-A2EB000X
Encoder Connector	ASD-ABEN0000

(X=3 indicates that the cable length is 3m; X=5 indicates that the cable length is 5m)

### 750W Servo Drive and 100W Low Inertia Servo Motor

Servo Drive	ASD-M-0721-□
Low Inertia Servo Motor	ECMA-C △ 0401 □ S
Power Cable (Without Brake)	ASD-ABPW000X
Power Connector (Without Brake)	ASDBCAPW0000
Power Cable (With Brake)	ASD-ABPW010X
Power Connector (With Brake)	ASDBCAPW0100
Incremental Encoder Cable	ASD-ABEN000X
Absolute Encoder Cable	ASD-A2EB000X
Encoder Connector	ASD-ABEN0000

(X=3 indicates that the cable length is 3m; X=5 indicates that the cable length is 5m)

### 750W Servo Drive and 200W Low Inertia Servo Motor

Servo Drive	ASD-M-0721-□
Low Inertia Servo Motor	ECMA-C △ 0602 □ S
Power Cable (Without Brake)	ASD-ABPW000X
Power Connector (Without Brake)	ASDBCAPW0000
Power Cable (With Brake)	ASD-ABPW010X
Power Connector (With Brake)	ASDBCAPW0100
Incremental Encoder Cable	ASD-ABEN000X
Absolute Encoder Cable	ASD-A2EB000X
Encoder Connector	ASD-ABEN0000

(X=3 indicates that the cable length is 3m; X=5 indicates that the cable length is 5m)

# Accessories Combinations

## 750W Servo Drive and 400W Low Inertia Servo Motor

Servo Drive	ASD-M-0721-□
Low Inertia Servo Motor	ECMA-C △ 0604 □ S ECMA-C △ 0604 □ H ECMA-C △ 0804 □ 7
Power Cable (Without Brake)	ASD-ABPW000X
Power Connector (Without Brake)	ASDBCAPW0000
Power Cable (With Brake)	ASD-ABPW010X
Power Connector (With Brake)	ASDBCAPW0100
Incremental Encoder Cable	ASD-ABEN000X
Absolute Encoder Cable	ASD-A2EB000X
Encoder Connector	ASD-ABEN0000

(X=3 indicates that the cable length is 3m; X=5 indicates that the cable length is 5m)

## 750W Servo Drive and 500W Medium Inertia Servo Motor

Servo Drive	ASD-M-0721-□
Medium Inertia Servo Motor	ECMA-E △ 1305 □ S
Power Cable (Without Brake)	ASD-CAPW100X
Power Cable (With Brake)	ASD-CAPW110X
Power Connector	ASD-CAPW1000
Power Connector (With Brake)	ASD-CAEN100X
Incremental Encoder Cable	ASD-CAEN100X
Absolute Encoder Cable	ASD-A2EB100X
Encoder Connector	ASD-CAEN1000

(X=3 indicates that the cable length is 3m; X=5 indicates that the cable length is 5m)

## 750W Servo Drive and 300W High Inertia Servo Motor

Servo Drive	ASD-M-0721-□
High Inertia Servo Motor	ECMA-G △ 1303 □ S
Power Cable (Without Brake)	ASD-CAPW100X
Power Connector (Without Brake)	ASD-CAPW110X
Power Cable (With Brake)	ASD-CAPW1000
Power Connector (With Brake)	ASD-CAEN100X
Incremental Encoder Cable	ASD-A2EB100X
Absolute Encoder Cable	ASD-CAEN1000
Encoder Connector	ASD-CAEN1000

(X=3 indicates that the cable length is 3m; X=5 indicates that the cable length is 5m)



## 750W Servo Drive and 750W Low Inertia Servo Motor

Servo Drive	ASD-M-0721-□
Low Inertia Servo Motor	ECMA-C △ 0807 □ S ECMA-C △ 0807 □ H ECMA-C △ 0907 □ S
Power Cable (Without Brake)	ASD-ABPW000X
Power Connector (Without Brake)	ASDBCAPW0000
Power Cable (With Brake)	ASD-ABPW010X
Power Connector (With Brake)	ASDBCAPW0100
Incremental Encoder Cable	ASD-ABEN000X
Absolute Encoder Cable	ASD-A2EB000X
Encoder Connector	ASD-ABEN0000

(X=3 indicates that the cable length is 3m; X=5 indicates that the cable length is 5m)

## 750kW Servo Drive and 600kW High Inertia Servo Motor

Servo Drive	ASD-M-1521-□
Medium Inertia Servo Motor	ECMA-F △ 1308 □ S
Power Cable (Without Brake)	ASD-CAPW100X
Power Cable (With Brake)	ASD-CAPW110X
Power Connector	ASD-CAPW1000
Incremental Encoder Cable	ASD-CAEN100X
Absolute Encoder Cable	ASD-A2EB100X
Encoder Connector	ASD-CAEN1000

(X=3 indicates that the cable length is 3m; X=5 indicates that the cable length is 5m)

## 1.5kW Servo Drive and 850W High Inertia Servo Motor

Servo Drive	ASD-M-1521-□
High Inertia Servo Motor	ECMA-C △ 1010 □ S
Power Cable (Without Brake)	ASD-CAPW100X
Power Cable (With Brake)	ASD-CAPW110X
Power Connector	ASD-CAPW1000
Incremental Encoder Cable	ASD-CAEN100X
Absolute Encoder Cable	ASD-A2EB100X
Encoder Connector	ASD-CAEN1000

(X=3 indicates that the cable length is 3m; X=5 indicates that the cable length is 5m)

## 1.5kW Servo Drive and 1kW Low Inertia Servo Motor

Servo Drive	ASD-M-1521-□
Low Inertia Servo Motor	ECMA-C △ 0910 □ S
Power Cable (Without Brake)	ASD-ABPW000X
Power Connector (Without Brake)	ASDBCAPW0000
Power Cable (With Brake)	ASD-ABPW010X
Power Connector (With Brake)	ASDBCAPW0100
Incremental Encoder Cable	ASD-ABEN000X
Absolute Encoder Cable	ASD-A2EB000X
Encoder Connector	ASD-ABEN0000

(X=3 indicates that the cable length is 3m; X=5 indicates that the cable length is 5m)

# Accessories Combinations

## 1.5kW Servo Drive and 1kW Low Inertia Servo Motor

Servo Drive	ASD-M-0721-□
Low Inertia Servo Motor	ECMA-G △ 1306 □ S
Power Cable (Without Brake)	ASD-CAPW100X
Power Cable (With Brake)	ASD-CAPW110X
Power Connector	ASD-CAPW1000
Incremental Encoder Cable	ASD-CAEN100X
Absolute Encoder Cable	ASD-A2EB100X
Encoder Connector	ASD-CAEN1000

(X=3 indicates that the cable length is 3m; X=5 indicates that the cable length is 5m)

## 1.5kW Servo Drive and 1kW Medium Inertia Servo Motor

Servo Drive	ASD-M-1521-□
Medium Inertia Servo Motor	ECMA-E △ 1310 □ S
Power Cable (Without Brake)	ASD-CAPW100X
Power Cable (With Brake)	ASD-CAPW110X
Power Connector	ASD-CAPW1000
Incremental Encoder Cable	ASD-CAEN100X
Absolute Encoder Cable	ASD-A2EB100X
Encoder Connector	ASD-CAEN1000

(X=3 indicates that the cable length is 3m; X=5 indicates that the cable length is 5m)

## 1.5kW Servo Drive and 900kW High Inertia Servo Motor

Servo Drive	ASD-M-1521-□
High Inertia Servo Motor	ECMA-E △ 1309 □ S
Power Cable (Without Brake)	ASD-CAPW100X
Power Cable (With Brake)	ASD-CAPW110X
Power Connector	ASD-CAPW1000
Incremental Encoder Cable	ASD-CAEN100X
Absolute Encoder Cable	ASD-A2EB100X
Encoder Connector	ASD-CAEN1000

(X=3 indicates that the cable length is 3m; X=5 indicates that the cable length is 5m)

## 1.5kW Servo Drive and 1.5kW Medium Inertia Servo Motor

Servo Drive	ASD-M-1521-□
Medium Inertia Servo Motor	ECMA-E △ 1315 □ S
Power Cable (Without Brake)	ASD-CAPW100X
Power Cable (With Brake)	ASD-CAPW110X
Power Connector	ASD-CAPW1000
Incremental Encoder Cable	ASD-CAEN100X
Absolute Encoder Cable	ASD-A2EB100X
Encoder Connector	ASD-CAEN1000

(X=3 indicates that the cable length is 3m; X=5 indicates that the cable length is 5m)



### NOTE

- 1) The boxes ( □ ) at the ends of the servo drive model names are for optional configurations. For the actual model name, please refer to the model explanation of the servo drive.
- 2) The boxes ( □ ) in the model names represent shaft end/brake or the number of oil seal.
- 3) The triangles ( △ ) in the model names represent encoder type. △ =1: Incremental encoder, 20-bit ; △ =2: Incremental encoder, 17-bit)

## Accessories Combinations

Other Accessories ( for ASDA-M Series all models )	
Description	Delta Part Number
50-Pin I/O Signal Connector (Cn1)	ASD-CN5C0050
Terminal Block Module	ASD-BM-50A
RS-232 Communication Cable	ASD-CARS0003
Communication Cable between Drive and Computer (for PC)	DOP-CAUSBAB
CANopen Communication Cable	TAP-CB03 / TAP-CB05
CANopen Distribution Box	TAP-CN03 / TAP-CN05
RS-485 Connector	ASD-CNIE0B06
Regenerative Resistor 400W 40Ω	BR400W040
Regenerative Resistor 1kW 20Ω	BR1K0W020
Regenerative Resistor 1.5kW 5Ω	BR1K5W005

## Safety Information

Global Standards	ASDA-M Series is designed to fully comply with demanding international standards, such as IEC and EN, and others. for all fields of industrial automation technology.
EMS Standard	EN61000-4-6 Level 3
	EN61000-4-3 Level 3
	EN61000-4-2 Level 2 and 3
	EN61000-4-4 Level 3 ※ in the process of application to EN61000-4-4
	EN61000-4-8 Level 4
	EN61000-4-5 Level 3
Conducted & Radiated Emissions	Complies with EN550011 Class A Group 1, with external EMC filter
CE Marking	CE recognized. Complies with Directive 2006/95/EC of the European Parliament and EMC Directive 2004/108/EC. ※ in the process of application to EMC Directive 2004/108/EC
UL Approval	UL (U.S.), cUL (Canada) recognized.
Test Standard	IEC/EN50178, IEC/EN60529
	IP20
Vibration	1G less than 20Hz, 0.6G 20 to 50Hz. Complies with IEC/EN50178
Shock	15gn 11ms. Complies with IEC/EN600028-2-27
Pollution Degree	Degree 2. Complies with IEC/EN61800-5-1

## Regenerative Resistor Specifications

Servo Drive (kW)	Specifications of Built-in Regenerative Resistors		Min. Allowable Resistance (Ohm)
	Resistance (parameter P1-52) (Ohm)	Capacity (parameter P1-53) (Watt)	
0.75	40Ω	60W	20Ω
1.5	20Ω	100W	10Ω
Note	<ul style="list-style-type: none"> <li>When the fault, ALE05 (Regeneration Error) occurs, please increase the regenerative resistor capacity or decrease the regenerative resistor resistance. (The regenerative resistor resistance should not be less than the minimum allowable resistance listed in the above table.)</li> <li>If the situation is not improved after increasing the regenerative resistor capacity or decreasing the regenerative resistor resistance, please purchase regenerative resistor module.</li> <li>When combining multiple small-capacity regenerative resistors in parallel to increase the regenerative resistor capacity, make sure that the total resistance value of the regenerative resistors is not less than the minimum allowable resistance listed in the above table.</li> </ul>		



Smarter. Greener. Together.

## Industrial Automation Headquarters

### Delta Electronics, Inc.

Taoyuan Technology Center  
No.18, Xinglong Rd., Taoyuan District,  
Taoyuan City 33068, Taiwan  
TEL: 886-3-362-6301 / FAX: 886-3-371-6301

## Asia

### Delta Electronics (Shanghai) Co., Ltd.

No.182 Minyu Rd., Pudong Shanghai, P.R.C.  
Post code : 201209  
TEL: 86-21-6872-3988 / FAX: 86-21-6872-3996  
Customer Service: 400-820-9595

### Delta Electronics (Japan), Inc.

Tokyo Office  
Industrial Automation Sales Department  
2-1-14 Shibadaimon, Minato-ku  
Tokyo, Japan 105-0012  
TEL: 81-3-5733-1155 / FAX: 81-3-5733-1255

### Delta Electronics (Korea), Inc.

Seoul Office  
1511, 219, Gasan Digital 1-Ro., Geumcheon-gu,  
Seoul, 08501 South Korea  
TEL: 82-2-515-5305 / FAX: 82-2-515-5302

### Delta Energy Systems (Singapore) Pte Ltd.

4 Kaki Bukit Avenue 1, #05-04, Singapore 417939  
TEL: 65-6747-5155 / FAX: 65-6744-9228

### Delta Electronics (India) Pvt. Ltd.

Plot No.43, Sector 35, HSIIDC Gurgaon,  
PIN 122001, Haryana, India  
TEL: 91-124-4874900 / FAX : 91-124-4874945

### Delta Electronics (Thailand) PCL.

909 Soi 9, Moo 4, Bangpoo Industrial Estate (E.P.Z),  
Pattana 1 Rd., T.Phraksa, A.Muang,  
Samutprakarn 10280, Thailand  
TEL: 66-2709-2800 / FAX : 662-709-2827

### Delta Energy Systems (Australia) Pty Ltd.

Unit 20-21/45 Normanby Rd., Notting Hill Vic 3168, Australia  
TEL: 61-3-9543-3720

## Americas

### Delta Electronics (Americas) Ltd.

Raleigh Office  
P.O. Box 12173, 5101 Davis Drive,  
Research Triangle Park, NC 27709, U.S.A.  
TEL: 1-919-767-3813 / FAX: 1-919-767-3969

### Delta Greentech (Brasil) S/A

São Paulo Office  
Rua Itapeva, 26 – 3º Andar - Bela Vista  
CEP: 01332-000 – São Paulo – SP - Brasil  
TEL: 55-11-3530-8642 / 55-11-3530-8640

### Delta Electronics International Mexico S.A. de C.V.

Mexico Office  
Vía Dr. Gustavo Baz No. 2160, Colonia La Loma,  
54060 Tlalnepanlta Estado de Mexico  
TEL: 52-55-2628-3015 #3050/3052

## EMEA

### Headquarters: Delta Electronics (Netherlands) B.V.

Sales: Sales.IA.EMEA@deltaww.com  
Marketing: Marketing.IA.EMEA@deltaww.com  
Technical Support: iatechnicalsupport@deltaww.com  
Customer Support: Customer-Support@deltaww.com  
Service: Service.IA.emea@deltaww.com  
TEL: +31(0)40 800 3800

### BENELUX: Delta Electronics (Netherlands) B.V.

De Witbogt 20, 5652 AG Eindhoven, The Netherlands  
Mail: Sales.IA.Benelux@deltaww.com  
TEL: +31(0)40 800 3800

### DACH: Delta Electronics (Netherlands) B.V.

Coesterweg 45, D-59494 Soest, Germany  
Mail: Sales.IA.DACH@deltaww.com  
TEL: +49(0)2921 987 0

### France: Delta Electronics (France) S.A.

ZI du bois Challand 2, 15 rue des Pyrénées,  
Lisses, 91090 Evry Cedex, France  
Mail: Sales.IA.FR@deltaww.com  
TEL: +33(0)1 69 77 82 60

### Iberia: Delta Electronics Solutions (Spain) S.L.U

Ctra. De Villaverde a Vallecas, 265 1º Dcha Ed.  
Hormigueras – P.I. de Vallecas 28031 Madrid  
TEL: +34(0)91 223 74 20

Carrer Llacuna 166, 08018 Barcelona, Spain

Mail: Sales.IA.Iberia@deltaww.com

### Italy: Delta Electronics (Italy) S.r.l.

Ufficio di Milano Via Senigallia 18/2 20161 Milano (MI)  
Piazza Grazioli 18 00186 Roma Italy  
Mail: Sales.IA.Italy@deltaww.com  
TEL: +39 02 64672538

### Russia: Delta Energy System LLC

Vereyskaya Plaza II, office 112 Vereyskaya str.  
17 121357 Moscow Russia  
Mail: Sales.IA.RU@deltaww.com  
TEL: +7 495 644 3240

### Turkey: Delta Greentech Elektronik San. Ltd. Sti. (Turkey)

Şerifaii Mah. Hendem Cad. Kule Sok. No:16-A  
34775 Ümraniye – İstanbul  
Mail: Sales.IA.Turkey@deltaww.com  
TEL: + 90 216 499 9910

### GCC: Delta Energy Systems AG (Dubai BR)

P.O. Box 185668, Gate 7, 3rd Floor, Hamarain Centre  
Dubai, United Arab Emirates  
Mail: Sales.IA.MEA@deltaww.com  
TEL: +971(0)4 2690148

### Egypt + North Africa: Delta Electronics

511 Cairo Business Plaza, North 90 street,  
New Cairo, Cairo, Egypt  
Mail: Sales.IA.MEA@deltaww.com