



CMC-EIP01

EtherNet/IP Communication Card Operation Manual

Series

VFD-C2000

VFD-CP2000

VFD-CH2000

VFD-CT2000



<http://www.delta.com.tw/industrialautomation>

Warning

- ✓ This operation manual provides information on specifications, installation, basic operation, setup and details of the communication protocol.
- ✓ AC motor drive is a delicate electrical and electronic product. For the safety of operator and the mechanical equipment, please allow professional electrical mechanics to do the trial run and adjust parameters for you. Should there be any questions, please consult your local Delta distributors. Our professional staff will be happy to help you.
- ✓ Please read this operation manual thoroughly and follow the instructions in case damage on the device or injury on the operation staff occur.

Table of Content

1	Introduction to CMC-EIP01	4
1.1	Features	4
1.2	Specifications	4
2	Product Profile and Outline	5
2.1	Dimension	5
2.2	Parts	5
2.3	LED Indicator	6
2.4	RJ-45 PIN Definition	6
2.5	Error Codes	6
2.6	Trouble-shooting	7
3	Installation and Wiring	8
3.1	How to Install	8
3.2	How to Disconnect	8
3.3	How to Connect to Network	9
4	Internal Register	10
4.1	Basic Registers (BR) (BR MODBUS Address Base = 0x0000)	10
4.2	Explanations on BR	10
4.3	Alarm Register (AL) (AL MODBUS Address Base = 0x0200)	11
4.4	Input Buffer Register (IN) (IN MODBUS Address Base = 0x0500)	11
4.5	Output Buffer Register (OUT) (OUT MODBUS Address Base = 0x0600)	11
4.6	Monitor Word Register (MW MODBUS Address Base = 0x2200)	11
4.7	Explanations on MW	12
4.8	Definitions of Parameter Address for VFD-C2000 Communication Protocol	13
4.9	Definitions of Parameter Address for Keypad ↔ VFD-C2000 Communication Protocol	14
5	MODBUS Communication	15

6	EtherNet/IP Communication Protocol	15
6.1	EtherNet/IP Specifications Supported.....	15
6.2	EtherNet/IP Communication Parameter	16
6.3	Services and Objects Supported	16
6.4	CIP Comman Status Code.....	16
6.5	Error Code for Monitor Request.....	16
7	Software Setting	17
7.1	Setting up Communication and Searching for Modules in DCISoft	18
7.2	Basic Settings	23
7.3	Network Settings.....	25
7.4	Alarm Setting	27
7.5	IP Filter	28
7.6	Parameter List	29
7.7	Monitor.....	30
7.8	Security.....	31
7.9	Returning to Default Settings.....	32
8	Application Examples	33
8.1	Write Frequency of VFD-C2000 by DVP-SV + DVPEN01-SL through Network (MODBUS TCP)	33
8.2	Monitor VFD-C2000 Parameters On-Line through DCISoft/Web	34
8.3	Set up and Clear Password	36
8.4	IP Filter Protection	39
8.5	E-Mail.....	41
8.6	Keypad Operation (1)	43
8.7	Keypad Operation (2)	44
8.8	Keypad Operation (3)	46
8.9	EtherNet/IP Application.....	48
Appendix A: EtherNet/IP Services and Objects		49
A.1	Objects Supported	49
A.2	Data Formates Supported	49
A.3	Identity Object (Class Code: 0x01)	49
A.3.1	Instance Code: 0x01	49
A.3.2	Instance Attributes	49
A.3.3	Common Services	50
A.4	Message Router Object (Class Code: 0x02)	50
A.4.1	Instance Code: 0x01	50
A.4.2	Instance Attributes: None.....	50
A.4.3	Common Services	50
A.5	Assembly Object (Class Code: 0x04).....	50
A.5.1	Instance Code.....	50

A.5.2	Instance Attributes	50
A.5.3	Common Services	50
A.6	Connection Manager Object (Class Code: 0x06).....	50
A.6.1	Instance Code: 0x01	50
A.6.2	Instance Attributes: None	50
A.6.3	Services.....	50
A.7	BR Object (Class Code: 0x64)	51
A.7.1	Instance Code	51
A.7.2	Instance Attributes	51
A.7.3	Common Services	51
A.8	AL Object (Class Code: 0x65).....	51
A.8.1	Instance Code	51
A.8.2	Instance Attributes	51
A.8.3	Common Services	51
A.9	MW Object (Class Code: 0x66).....	51
A.9.1	Instance Code	51
A.9.2	Instance Attributes	52
A.9.3	Common Services	52
A.10	TCP/IP Interface Object (Class Code: 0xF5).....	52
A.10.1	Instance Code: 0x01	52
A.10.2	Instance Attributes	52
A.10.3	Common Services	53
A.11	Ethernet Link Object (Class Code: 0xF6).....	53
A.11.1	Instance Code: 0x01	53
A.11.2	Instance Attributes	53
A.11.3	Services.....	53

1 Introduction to CMC-EIP01

Thank you for choosing Delta CMC-EIP01 communication card. To ensure correct installation and operation of the product, please read this operation manual carefully before using it.

CMC-EIP01 is an EtherNet/IP communication card, supporting EtherNet/IP protocol and one MODBUS TCP protocol connection and able to conduct remote setup and monitoring through DCISoft or Web. It also supports remote monitoring by using SCADA (Supervisory Control And Data Acquisition) software or human machine interface. Sending e-mail, IP filter, on-line monitoring and webpage functions are also provided by CMC-EIP01. In addition, by auto MDI/MDI-X function, no jumper cable is required when using the network cable.

1.1 Features

- Auto-detects transmission speed 10/100 Mbps
- Auto MDI/MDI-X
- Supports MODBUS TCP slave communication protocol (1 connection)
- E-mail alarm
- Web browser setup and on-line monitoring
- Supports EtherNet/IP explicit message Class 3

1.2 Specifications

■ Specification

Connector	RJ-45 with Auto MDI/MDIX
Number of ports	1 Port
Interface	Ethernet
Cable	Category 5e shielding 100M
Speed	10/100 Mbps Auto-Detect
Protocol	ICMP, IP, TCP, UDP, DHCP, SMTP, HTTP, MODBUS TCP, EtherNet/IP, Delta Configuration

■ Environment

Noise immunity	ESD (IEC 61800-5-1, IEC 61000-4-2) EFT (IEC 61800-5-1, IEC 61000-4-4) Surge Teat (IEC 61800-5-1, IEC 61000-4-5) Conducted Susceptibility Test (IEC 61800-5-1, IEC 61000-4-6)
Operation	-10°C ~ 50°C (temperature), 90% (humidity)
Storage	-25°C ~ 70°C (temperature), 95% (humidity)
Vibration/shock immunity	International standard: IEC 61800-5-1, IEC 60068-2-6/IEC 61800-5-1, IEC 60068-2-27
Standards	

■ Electrical Specification

Power supply voltage	5 VDC
Power consumption	0.8 W
Insulation voltage	500 VDC
Weight	25g

2 Product Profile and Outline

2.1 Dimension

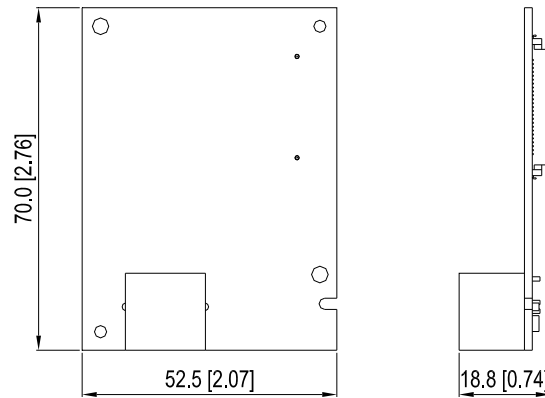

Unit: mm [inch]

2.2 Parts

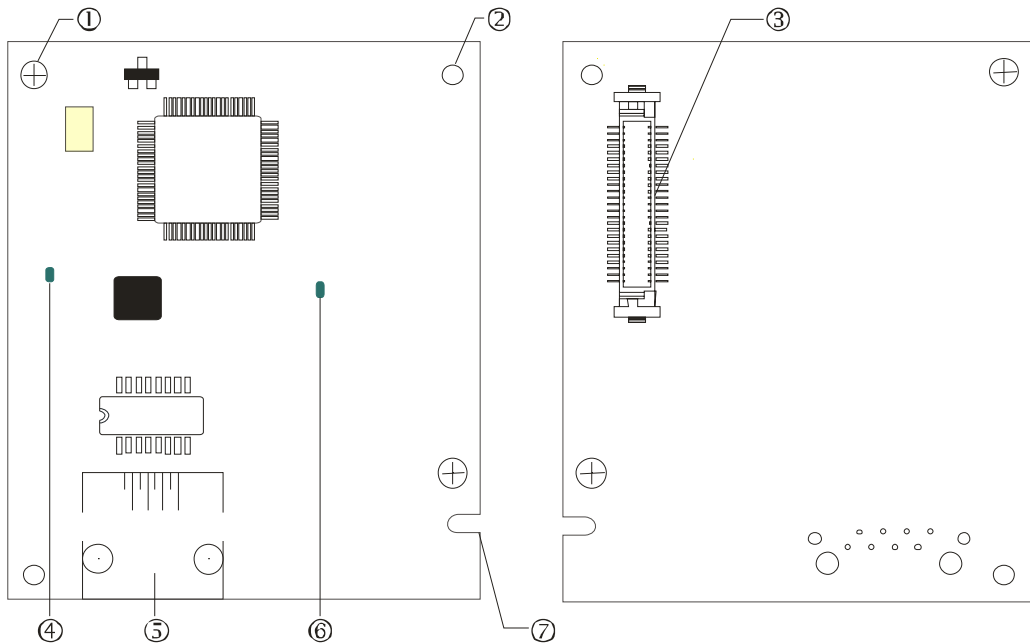

①	Screw fixing hole	⑤	RJ-45 connection port
②	Positioning hole	⑥	POWER indicator
③	AC motor drive connection port	⑦	Fool-proof groove
④	LINK indicator		

2.3 LED Indicator

LED	Status	Indication	How to correct	
POWER	Green	On	Power supply in normal status	--
		Off	No power supply	Check the power supply.
LINK	Green	On	Network connection in normal status	--
		Flashes	Network in operation	--
		Off	Network not connected	Check if the network cable is connected.

2.4 RJ-45 PIN Definition

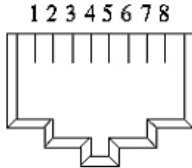
RJ-45 sketch	PIN	Signal	Definition
	1	Tx+	Positive pole for data transmission
	2	Tx-	Negative pole for data transmission
	3	Rx+	Positive pole for data receiving
	4	--	N/C
	5	--	N/C
	6	Rx-	Negative pole for data receiving
	7	--	N/C
	8	--	N/C

2.5 Error Codes

ID	Code	Definition
75	ECFF	Incorrect default setting
76	ECiF	Serious internal error
80	ECEF	Ethernet connection error
81	ECto	Communication timeout between CMC-EIP01 and VFD-C2000
82	ECCS	Checksum error in the communication between CMC-EIP01 and VFD-C2000
83	ECrF	Reset CMC-EIP01 to default setting
85	ECo1	Exceeds max. number of communications in EtherNet/IP
86	ECiP	IP error
87	EC3F	Mail alarm

2.6 Trouble-shooting

Abnormality	Cause	How to correct
POWER LED off	AC motor drive not powered	Check if the AC motor drive is powered and the power supply is in normal status.
	CMC-EIP01 not connected to AC motor drive	Make sure CMC-EIP01 is tightly connected to AC motor drive.
LINK LED off	CMC-EIP01 not connected to network	Make sure the network cable is correctly connected to the network.
	Poor contact to RJ-45 connector	Make sure RJ-45 connector is connected to Ethernet port.
No communication Card found	CMC-EIP01 not connected to the network	Make sure CMC-EIP01 is connected to the network.
	PC and CMC-EIP01 in different networks and blocked by firewall.	Search by IP or set up relevant settings by the keypad on AC motor drive.
Fail to open CMC-EIP01 setup page	CMC-EIP01 not connected to network	Make sure CMC-EIP01 is connected to the network.
	Incorrect communication setting in DCISoft	Make sure the communication setting in DCISoft is set to Ethernet.
	PC and CMC-EIP01 in different networks and blocked by firewall	Conduct the setup by the keypad on AC motor drive.
Able to open CMC-EIP01 setup page but fail to utilize webpage monitoring	Incorrect network setting in CMC-EIP01	Check if the network setting for CMC-EIP01 is correct. For the Intranet setting in your company, please consult your IT staff. For the Internet setting in your home, please refer to the network setting instruction provided by your ISP.
Fail to send e-mail	Incorrect network setting in CMC-EIP01	Check if the network setting for CMC-EIP01 is correct.
	Incorrect mail server setting	Please confirm the IP address for SMTP Server.

3 Installation and Wiring

In this section, we illustrate how to connect CMC-EIP01 to VFD-C2000 and the network.

3.1 How to Install

How to connect CMC-EIP01 to VFD-C2000 series AC motor drive:

- Switch off the power supply of VFD-C2000.
- Open the front cover of VFD-C2000.
- Place the insulation spacer into the positioning pin at Slot 1 (see [Figure 1]) and aim the two holes on the PCB at the positioning pin. Press the pin to clip the holes with the PCB (see [Figure 2]).
- Screw up at torque 6~8 kg-cm (5.21~6.94 in-lbs) after the PCB is clipped with the holes (see [Figure 3]).

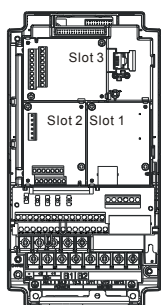

[Figure 1]

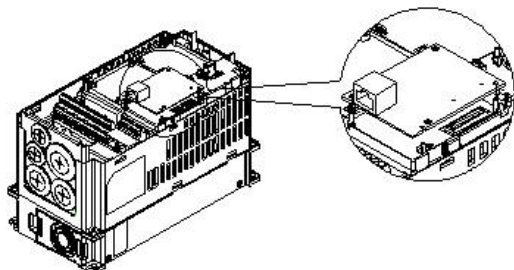

[Figure 2]

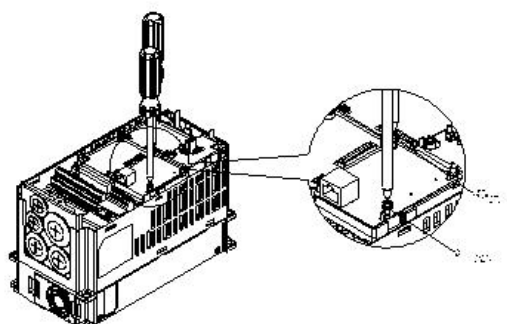

[Figure 3]

3.2 How to Disconnect

How to disconnect CMC-EIP01 from VFD-C2000:

- Switch off the power of VFD-C2000.
- Open the front cover of VFD-C2000.
- Remove the two screws (see [Figure 1]).
- Twist open the card clip and insert the slot type screwdriver to the hollow to prize the PCB off the card clip (see [Figure 2]).
- Twist open the other card clip to remove the PCB (see [Figure 3]).

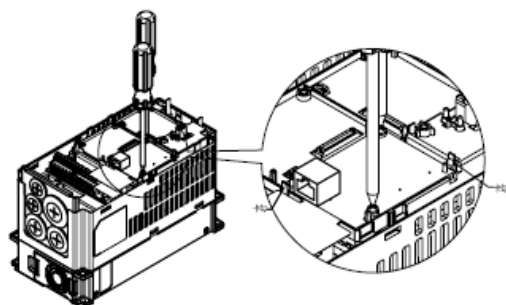

[Figure 1]

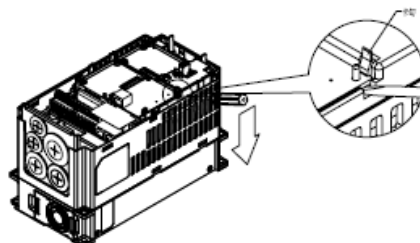

[Figure 2]

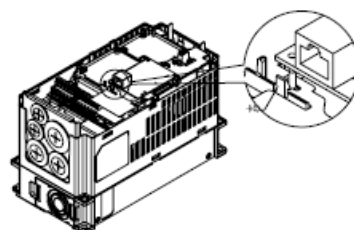

[Figure 3]

3.3 How to Connect to Network

Connect CMC-EIP01 to the Ethernet hub by CAT-5e pair twisted wire. Since CMC-EIP01 has auto MDI/MDIX function, so CAT-5e does not require jumper cable.

Network structure of PC and CMC-EIP01:

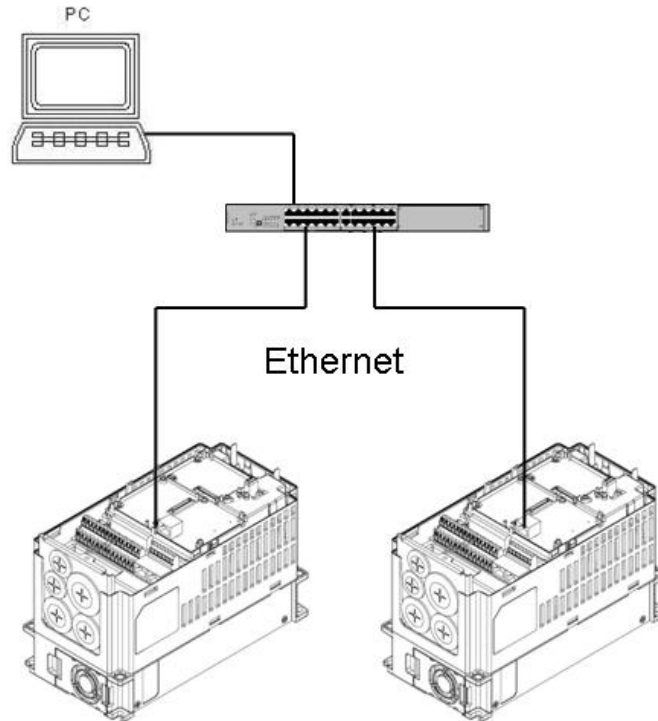

Note:

When operating VFD-C2000 through CMC-EIP01 on the network, set the controller of VFD-C2000 to CMC-EIP01 first.

Parameter settings:

Parameter	Set value	Function
00-20	8	Set the source of frequency command to "CMC-EIP01"
00-21	5	Set the source of control to "CMC-EIP01"
09-30	0	Communication decode way

4 Internal Register

4.1 Basic Registers (BR) (BR MODBUS Address Base = 0x0000)

BR#	Attribute	Content	Definition
#0	R	Model name	System defined and read only. Model code of CMC-EIP01: H'0204
#1	R	Firmware version	In hex form, displaying the current firmware version
#2	R	Release date of the version	In hex form
#6	R	VFD-C2000 station No.	1~254
#11	R	MODBUS communication timeout	Default: 50 (ms)
#13	R/W	Network keep alive time (TCP/IP)	Default: 30 (s)

4.2 Explanations on BR

BR#0: Model Name

Explanations:

Model code of CMC-EIP01 = H'0204

BR#1: Firmware Version

Explanations:

Displaying the firmware version of CMC-EIP01 in hex form, e.g. H'0100 indicates version V1.00.

BR#2: Release Date of the Version

Explanations:

Displaying the release date of the version in hex form, e.g. H'0101 indicates January 1.

BR#6: VFD-C2000 Station No.

Explanations:

Station No. of VFD-C2000 drive. Range: 1 ~ 254

BR#11: MODBUS Communication Timeout

Explanations:

For setting up the communication timeout (ms) in MODBUS TCP mode. Default: 50ms.

BR#13: Network Keep Alive Time (TCP/IP)

Explanations:

For setting the network keep alive time (s). Range: 10 ~ 65,535; Default: 30s. If the connection idle time exceeds the keep alive time, CMC-EIP01 will disconnect the idling connection.

4.3 Alarm Register (AL) (AL MODBUS Address Base = 0x0200)

AL#	bit in each AL	Attribute	Function	Explanation	
#0~#15	bit 15	R	Function enabling flag	bit 15 = 1 → Function enabled bit 15 = 0 → Function disabled	
	bit 4 ~ bit14	R	Reserved		
	bit 2~ bit 3	R	Type of triggered event		bit 3 bit 2
				Reserved	0 0
				Trigger e-mail	0 1
				Reserved	1 0
Reserved	1 1				
bit 1	R	Status of trigger	bit 1 = 0 → Not yet triggered bit 1 = 1 → Already triggered		
bit 0	R	Type of trigger	bit 0 = 0 → Triggered by software bit 0 = 1 → Triggered by hardware		

4.4 Input Buffer Register (IN) (IN MODBUS Address Base = 0x0500)

IN#	Attribute	Content	Explanation	Default	Latched
#0~#15	R/W	Buffer register for input data	EtherNet/IP input data	0	No

Symbol:
R – Read only; R/W – Can be read and written

Explanations:

The input buffer register sends the input data to the Ethernet. These IN correspond to addresses 0x2100 ~ 0x210F in VFD-C2000 and total 32 words.

4.5 Output Buffer Register (OUT) (OUT MODBUS Address Base = 0x0600)

OUT#	Attribute	Content	Explanation	Default	Latched
#0~#2	R/W	Buffer register for output data	EtherNet/IP output data	0	No

Symbol:
R – Read only; R/W – Can be read and written

Explanations:

The output buffer register sends the output data to VFD-C2000. These OUT correspond to addresses 0x2000 ~ 0x2002 in VFD-C2000 and total 6 words.

4.6 Monitor Word Register (MW MODBUS Address Base = 0x2200)

MW#	Attribute	Content	Explanation
#0	R	Monitor function	bit 15 = 1 → Cache mode enabled bit 15 = 0 → Cache mode disabled
#1~#32	R/W	Station No. and device address to be monitored	The low byte in odd MW records the station No. of device to be monitored, and high byte records the number of data to be monitored. Every MW holds one monitored register. The even MW records the address of register.
#201~#300	R	Value monitored	Every MW records one value monitored in a register.
#301~#307	R	Status monitored	Every MW records the status of 16 registers. 1: Normal; 0: Abnormal

4.7 Explanations on MW

MW#0: Monitor Function

Explanations:

Default: H'8010

MW#1 ~ MW#32: Station No. and Device Address to be Monitored

Explanations:

The low byte in odd MW records the station No. of device to be monitored, and high byte records the number of data to be monitored. Every MW holds one monitored register. The even MW records the address of register.

MW#201 ~ MW#300: Value Monitored

Explanations:

Every MW records one value monitored in a register.

MW201	MW202	MW203	...	MW300
Device 1	Device 2		...	Device 100

MW#301 ~ MW#307: Status Monitored

Explanations:

Every MW records the status of 16 registers. 1: Normal; 0: Abnormal

MW301	B15	...	B1	B0
	Device 16	...	Device 2	Device 1
MW302	B15	...	B1	B0
	Device 32	...	Device 18	Device 17
.
MW307	B15	...	B1	B0
	Device 32	...	Device 18	Device 17

4.8 Definitions of Parameter Address for VFD-C2000 Communication Protocol

Parameter content	Address	Definition	
Parameter set in VFD-C2000	GGnnH	GG is the parameter group; nn is the parameter number. Ex: Parameter 04-01 is indicated by 0401H.	
Commands to VFD-C2000	2000H	bit0 ~ 3	0: No function
			1: Stop
			2: Run
		3: Enable JOG	
		bit4 ~ 5	00B: No function
			01B: Forward command
			10B: Reverse command
			11B: Change direction command
		bit6 ~ 7	00B: 1 st acceleration/deceleration section
			01B: 2 nd acceleration/deceleration section
			10B: 3 rd acceleration/deceleration section
			11B: 4 th acceleration/deceleration section
		bit8 ~ 11	0000B: Main speed
			0001B: 1 st speed section
			0010B: 2 nd speed section
			0011B: 3 rd speed section
			0100B: 4 th speed section
			0101B: 5 th speed section
			0110B: 6 th speed section
			0111B: 7 th speed section
			1000B: 8 th speed section
			1001B: 9 th speed section
			1010B: 10 th speed section
			1011B: 11 th speed section
			1100B: 12 th speed section
1101B: 13 th speed section			
1110B: 14 th speed section			
1111B: 15 th speed section			
bit12	1: Enable bit6 ~ 11		
bit13 ~ 14	00B: No function		
	01B: The command is operated by keypad.		
	10B: The command is operated by parameter setting (00-21)		
		11B: Change the operational source of the command	
	bit15	Reserved	
	2001H	Frequency command	
	2002H	bit0	1: E.F. = ON
		bit1	1: Reset command

EtherNet/IP Communication Card: CMC-EIP01

Parameter content	Address	Definition	
Commands to VFD-C2000	2002H	bit2	1: External interruption (B.B) = ON
		bit3~5	Reserved
Monitor VFD-C2000 status	2100H	Error code: Refer to parameter 06-17 ~ 06-22	
	2119H	bit0	1: Forward running command
		bit1	1: Running status
		bit2	1: JOG command
		bit3	1: Reverse command
		bit4	1: Reversing status
		bit8	1: Main frequency comes from communication interface
		bit9	1: Main frequency comes from analog/external terminal signal input
		bit10	1: The command is operated by communication interface
		bit11	1: Lock the parameter
		bit12	1: Enable parameter copy function in keypad
		bit13~15	Reserved
		2102H	Frequency command (F)
2103H	Output frequency (H)		
2104H	Output current (AXXX.X)		
2105H	DC bus voltage (UXXX.X)		
2106H	Output voltage (EXXX.X)		
2107H	Current execution speed of the multi-section command		
2109H	Counting value		
2116H	Multi-function display (parameter 00-04)		
211BH	Max. frequency		
2200H	Feedback signal %		
2201H	Reserved		
2203H	AVI percentage		
2204H	ACI percentage		
2205H	AUI percentage		
2206H	Temperature of IGBT		
2207H	Temperature of capacitor		
2208H	Status of digital input		
2209H	Status of digital output		

4.9 Definitions of Parameter Address for Keypad ⇔ VFD-C2000 Communication Protocol

Address	No. on keypad	Definition
-	09-00	VFD-C2000 Communication Address
2501H	09-61	CMC-EIP01 Firmware Version
2502H	09-62	CMC-EIP01 Product Code
2505H	09-63	CMC-EIP01 Fault

Address	No. on keypad	Definition
2520H	09-75	IP Configuration 0 – Static 1 – DHCP
2521H	09-76	IP Address 1
2522H	09-77	IP Address 2
2523H	09-78	IP Address 3
2524H	09-79	IP Address 4
2525H	09-80	Net Mask 1
2526H	09-81	Net Mask 2
2527H	09-82	Net Mask 3
2528H	09-83	Net Mask 4
2529H	09-84	Gateway 1
252AH	09-85	Gateway 2
252BH	09-86	Gateway 3
252CH	09-87	Gateway 4
252DH	09-88	Password Low (0~255)
252EH	09-89	Passwrod High (0~255)
252FH	09-90	Return to Factory Setting
2530H	09-91	CMC-EIP01 Setting bit 0: Enable IP Filter bit 1: Internet parameter enable bit 2: Login password enable
2531H	09-92	CMC-EIP01 Status bit 0: Password enable

5 MODBUS Communication

Function codes supported:

Code	Definition
0x03	Read register in VFD-C2000
0x06	Write single register in VFD-C2000
0x10	Write multiple registers in VFD-C2000

6 EtherNet/IP Communication Protocol

6.1 EtherNet/IP Specifications Supported

- Trigger type: Cyclic
- Transport class: 1
- Application behavior: Exclusive owner

Parameter	O→T		T→O	
	Data size		Fixed	
Connection type	Multicast, Point to Point		Multicast, Point to Point	

6.2 EtherNet/IP Communication Parameter

- Input buffer register: In Assembly Instance = 101, Width = 16 bits, Size = 16
- Output buffer register: Out Assembly Instance = 100, Width = 16 bits, Size = 3
- Configuration: Instance = 102, Width = 8 bits, Size = 0

6.3 Services and Objects Supported

See Appendix A.

6.4 CIP Comman Status Code

Status code	Status	Definition
0x 00	Success	Requested service is successfully executed.
0x 01	Connection failure	Connected service fails.
0x 04	Path segment error	Node in the program cannot identify the definition or syntax of a path segment. When this error takes place, the execution of program will be terminated.
0x 05	Path destination unknown	The path is related to object type, but the node in the program does not cover or cannot identify the type or structure of the object. When this error takes place, the execution of program will be terminated.
0x 08	Service not supported	The object does not support required service or has not yet defined the service.
0x 0E	Attribute not settable	Receives request of modifying unchangeable attribute
0x 13	Not enough data	Receives insufficient data and therefore cannot execute command
0x 14	Attribute not supported	Does not support requested attribute
0x 15	Too much data	The received data exceeds what the command execution requires.
0x 20	Invalid parameter	The requested parameter is invalid, indicating that the parameter does not fit the definition of the requirement, or the requirement has been defined in "Application Object Specification".
0x 26	Path size invalid	The size of the path transmitting requested service cannot afford the request to the object or cover too much route data.

6.5 Error Code for Monitor Request

Status code	Extended status code	Definition
0x00	—	The execution of service is successful.
0x01	0x0100	The connection is in progress or the connection is re-opened. The code will be sent back when the source is trying to establish a connection to the target but the target has already been connected.
0x01	0x0103	Does not support the combination of this transmission type and trigger. The target does not support the defined combination of transmission type and trigger. The router will not terminate the connection, only the target end has to send back this extended status code.
0x01	0x0106	Clash of control right A connection takes the control, blocking the establishment of other connections. When this device occupies the connection in this way, only one connection will be allowed to control this device.
0x01	0x0107	Cannot find the corresponding target to connect
0x01	0x0108	Invalid network connection parameter When the application program in the target does not support the defined connection type, connection level, or there are too many users, the extended status code will be sent back. Only the node on target has to send back the extended status code.

Status code	Extended status code	Definition
0x01	0x0109	Invalid setting of the size of the on-line data exchange zone This device does not support the setting of the current data exchange zone. The setting can be too big or too small.
0x01	0x0111	RPI setting not supported
0x01	0x0113	The number of connections exceeds the maximum. No further connections are able to connect to this device.
0x01	0x0114	The company ID does not match product code. The product code or company ID marked in the electronic key logic section does not match the record in the target device.
0x01	0x0115	Inconsistent product type The product type marked in the electronic key logic section does not match the record in the target device.
0x01	0x0116	Inconsistent version The primary and secondary revised versions marked in the electronic key logic section do not match the record in the target device.
0x01	0x0315	Invalid section exists in the path. The type or value of a section in the path is invalid. When the device cannot interpret the path, it will respond with this extended status code. Cause of this error: Unidentifiable path type, unexpected section type or other problems existing in the path.

7 Software Setting

This section gives instructions on how to set up the parameters of CMC-EIP01 by using Delta's Communication Software, DCISoft, and explanations on each setup page. Before you open the setup pages, you have to select "Ethernet" as the communication type. Next, you can search by "Search" or "IP search" function. CMC-EIP01 is set up by UDP port 20006; therefore, be aware of relevant settings of the firewall. The PC is connected to VFD-C2000 with CMC-EIP01 through cable or hub:

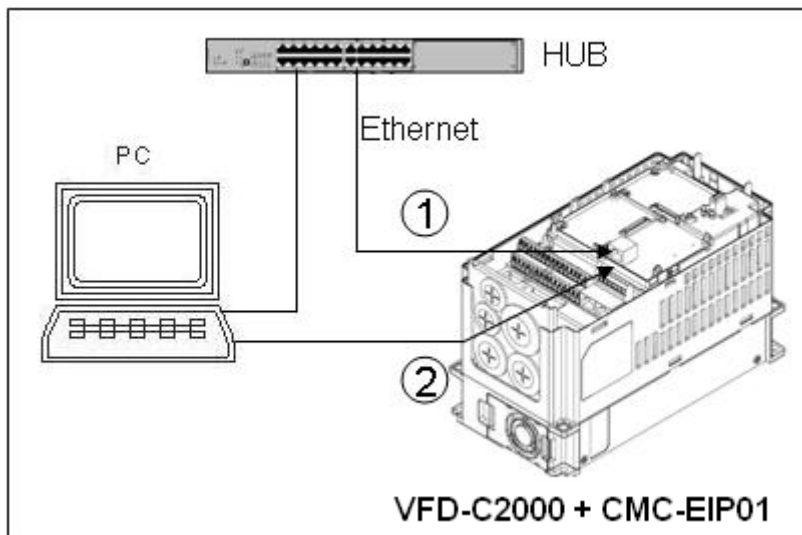

7.1 Setting up Communication and Searching for Modules in DCISoft

■ Communication Setting

1. Open DCISoft on the PC and select “Tools” => “Communication Setting”.

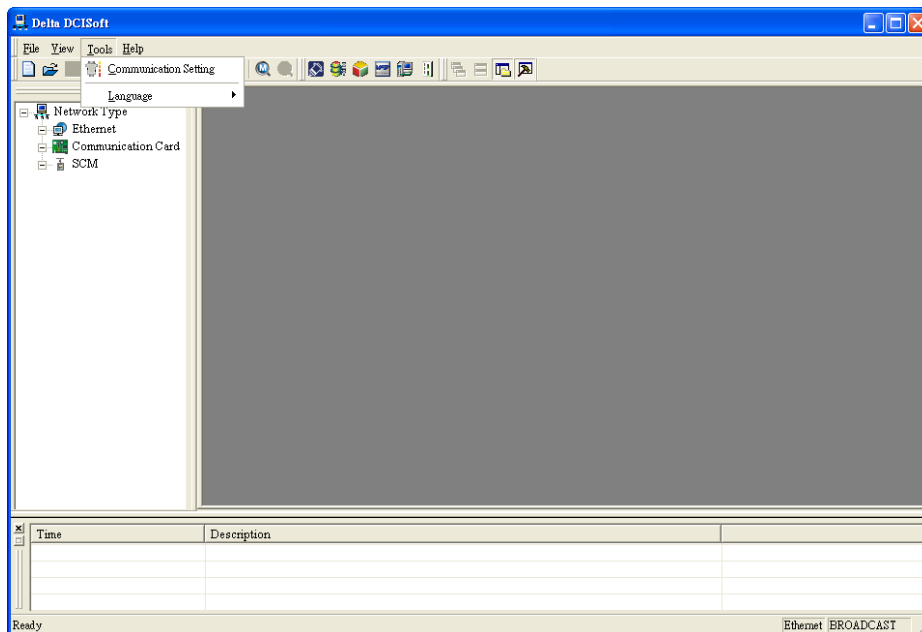

2. Select “Ethernet” for the communication setting.

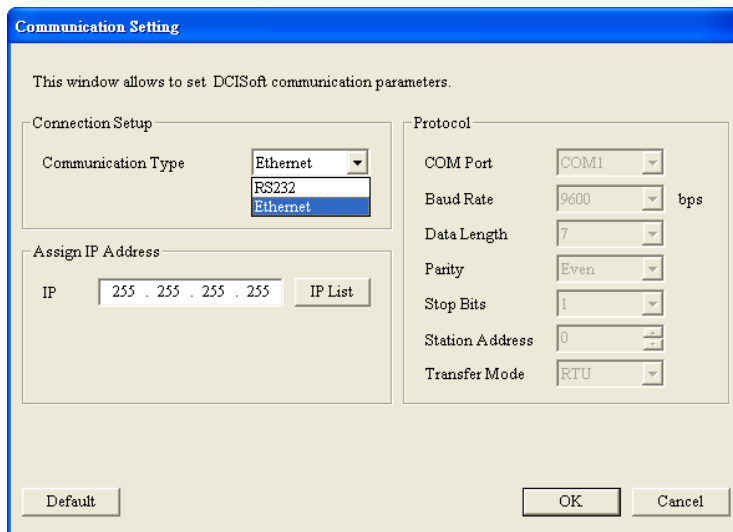

■ Search

1. Click the “Search” icon  in DCISoft to search for all Delta’s Ethernet products on the network by search function. The modules found are displayed in the left-hand side column, and the device list of all modules is displayed on the right-hand side column.

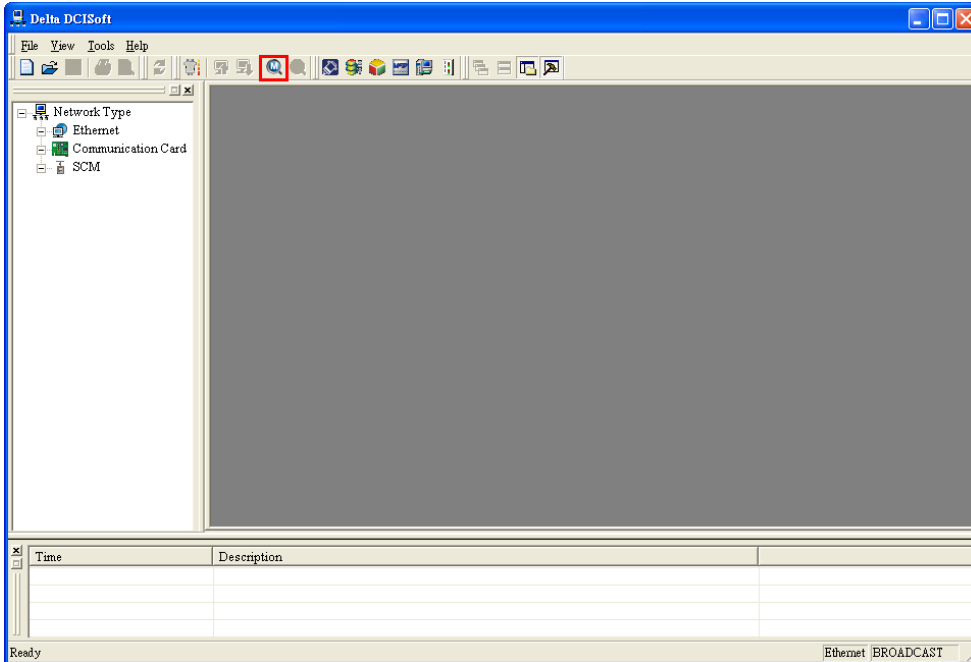

2. Click the module you need in the left-hand side column to display the device list of the module in the right-hand side column. Double click the device on the right-hand side column to enter the setup page of the device.

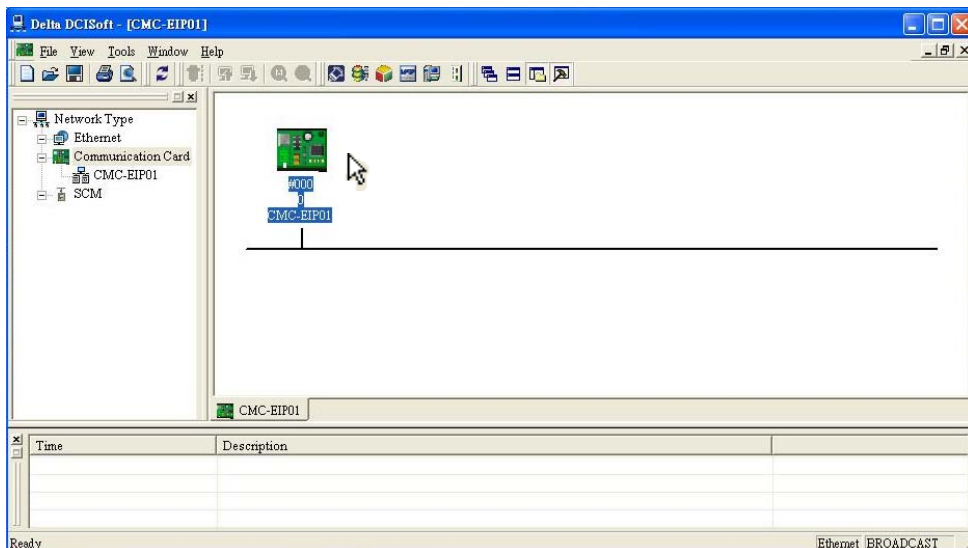

3. The setup page for CMC-EIP01.

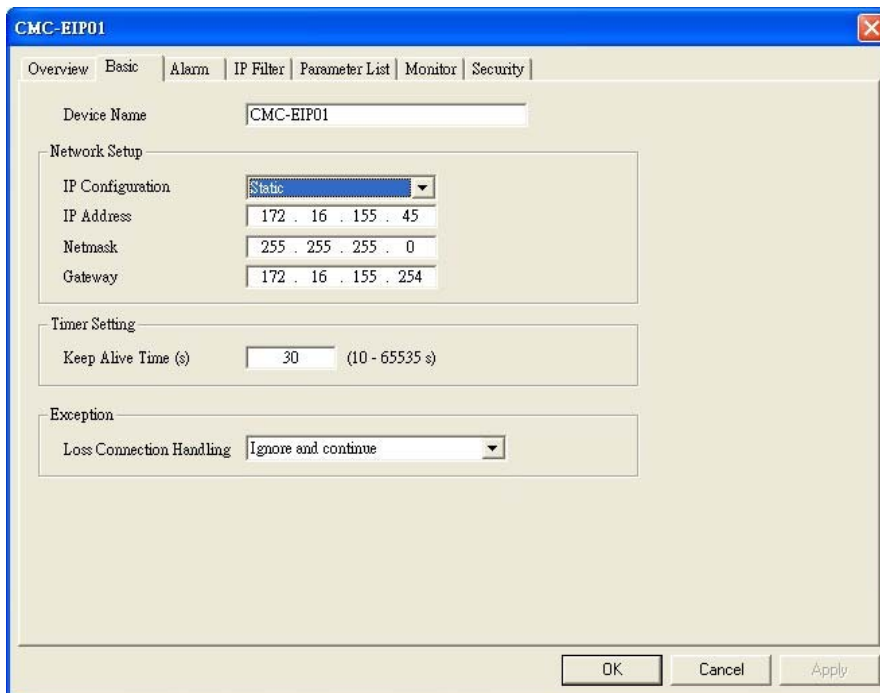

■ Search for Designated Module

1. Click "Communication Card" in the left-hand side column. Right click the mouse and select "Configure" to search for the designated module.

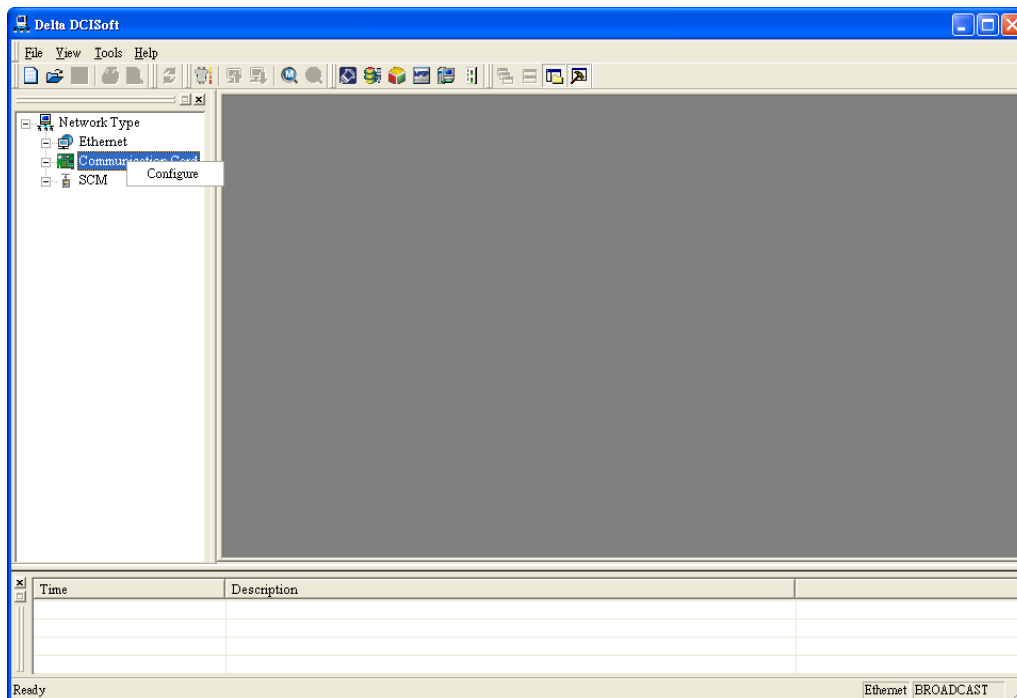

2. Select CMC-EIP01 to be searched. Click “OK” and DCISoft will start to search for the existing CMC-EIP01 cards on the network.

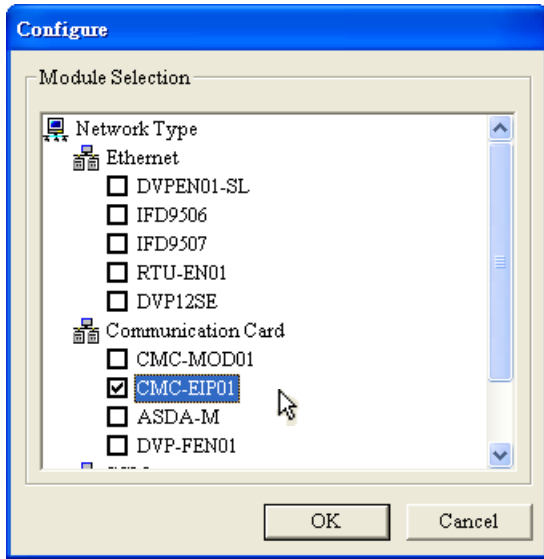

3. Device list of the existing CMC-EIP01.

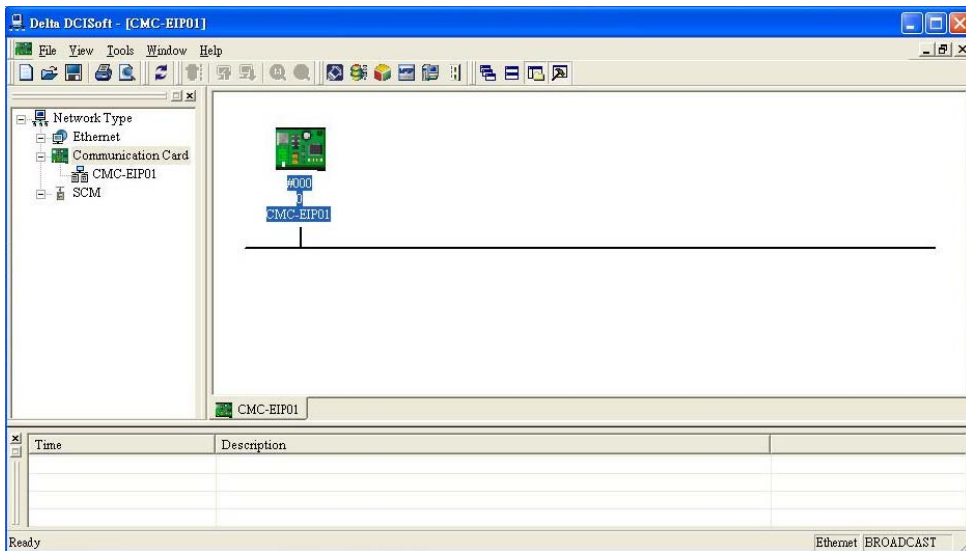

■ Search for Designated IP

1. Set the communication type to “Ethernet” and enter the designated IP address in the address column. Click “OK”.

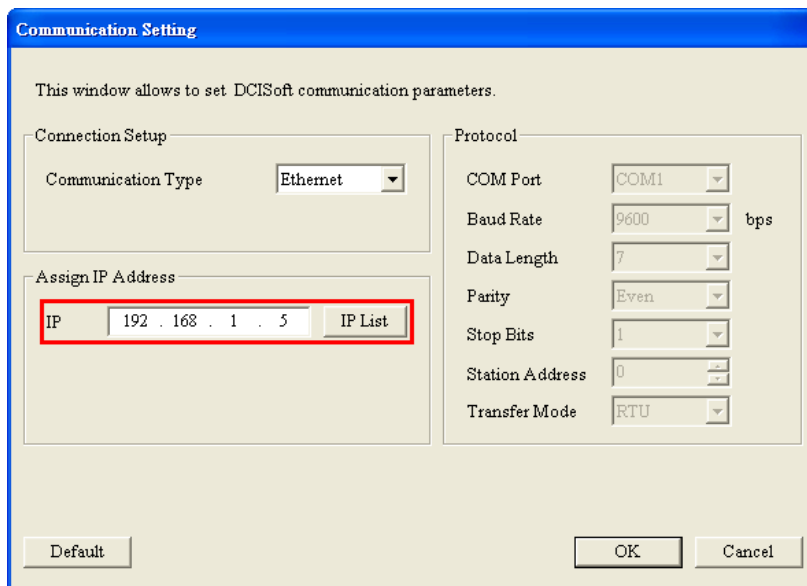

2. Click “IP Search” icon  to start searching for the designated IP.

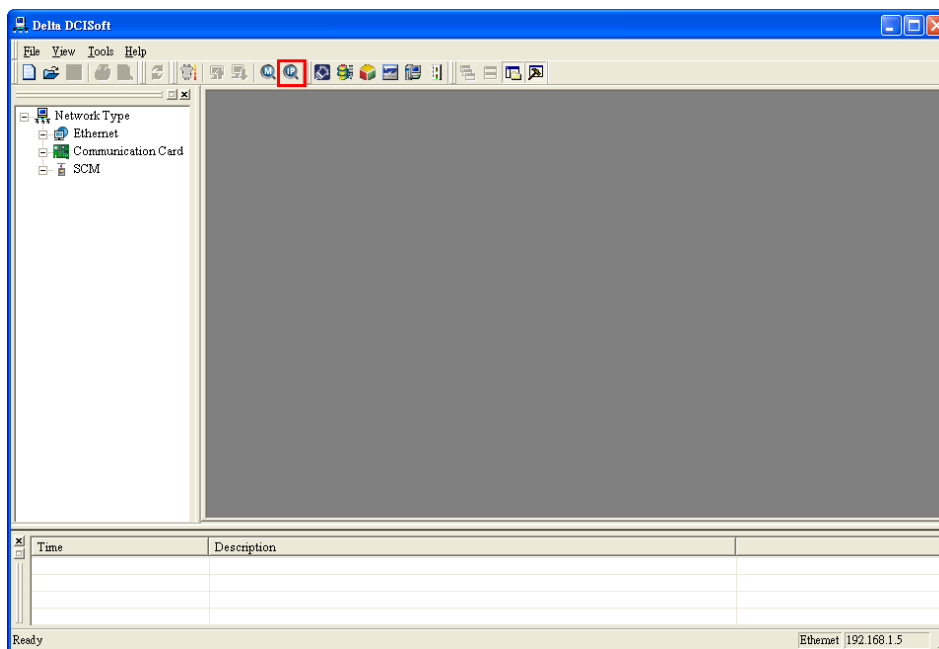

3. The CMC-EIP01 found is displayed in the right-hand side column. Double click the device to be set up to enter its setup page.

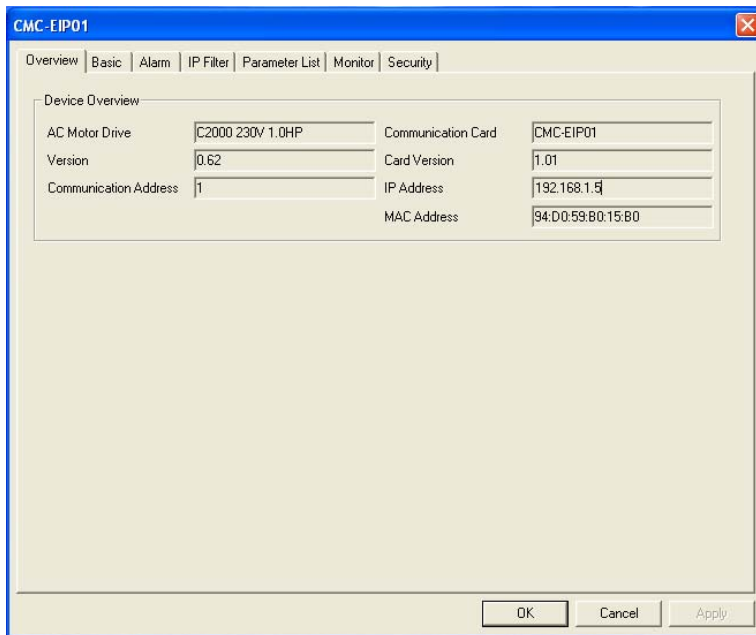

7.2 Basic Settings

The basic settings include the settings for device name, network and timer.

■ The basics

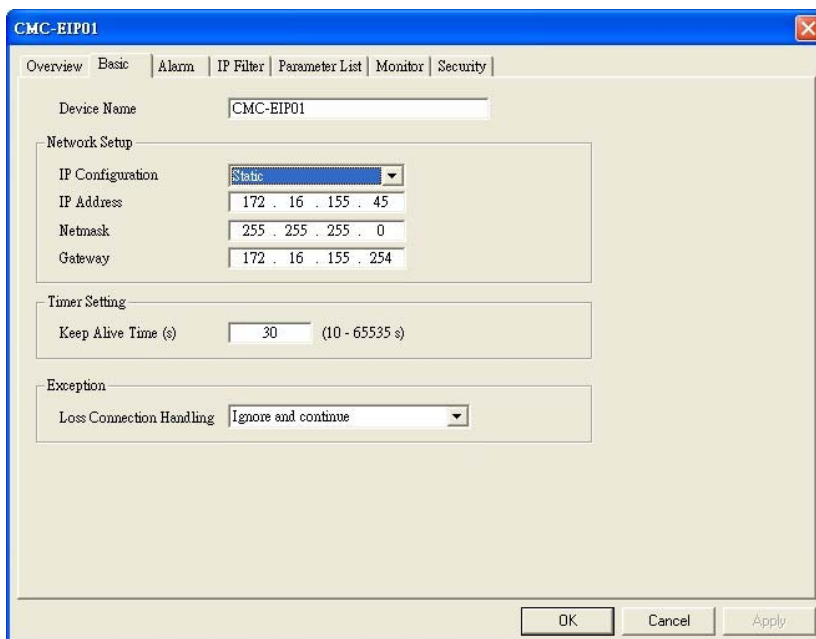

1. Device Name:

There can be many CMC-EIP01 cards on the network. Therefore, you can set up a device name for the module to be controlled to identify it when you need to search for it.
2. Network Setup:
 - (1) IP Configuration:

There are 2 types of IP configuration: Static IP and DHCP.

Static IP: Preset or manually modified by the user.

DHCP: Automatically updated by the server. There has to be a server on the LAN.

IP	Explanation
Static	The user manually enters the IP address, netmask and gateway.
DHCP	The polled DHCP offers the IP address, netmask and gateway.

(2) IP Address:

IP address is the location of equipment on the network. Every equipment connected to the network has to have an IP address. Incorrect IP address will result in connection failure. Consult you ISP for how to set up the IP address. The default IP for CMC-EIP01 is 192.168.1.5.

(3) Netmask:

Netmask is an important parameter for setting up the subnet, used for seeing if the destination IP and local equipment are in the same subnet. If not, the equipment will send the packet to the gateway, and the gateway will send the packet to another subnet. Incorrect setting may cause the destination equipment unable to communicate to CMC-EIP01. To see if your setting is correct, conduct bitwise AND operations between your IP and netmask and destination IP and netmask. If the two values obtained are the same, the two IPs are in the same subnet. The default netmask of CMC-EIP01 is 255.255.255.0.

(4) Gateway:

Gateway is the window for two different subnets, allowing two equipments in different subnets to communicate with each other. For example, if the LAN has to be connected to the WAN, it will need a gateway to bridge the communication. The IP of the gateway has to be in the same subnet as CMC-EIP01. The default gateway of CMC-EIP01 is 192.168.1.1.

3. Timer Setting

For setting up the network keep alive time (Unit: second; Range: 10 ~ 65,535; Default: 30s). If the idling time of the connection is longer than the keep alive time, CMC-EIP01 will disconnect the idling connection.

4. Execption

If the communication card detects that the network is disconnected, it can ask VFD-C2000 to stop (according to the setting in VFD-C2000), or ignore the error and main the current status. (This function is supported by CMC-EIP01 version 1.04 and above.)

7.3 Network Settings

The first step for all the equipment to connect to the network is to have its own IP (Internet Protocol) address. The IP address is like a number for every device on the network to be identified

■ Setting up static IP of the PC

1. Enter Control Panel → Network Connections → click “Local Area Connection 2”.

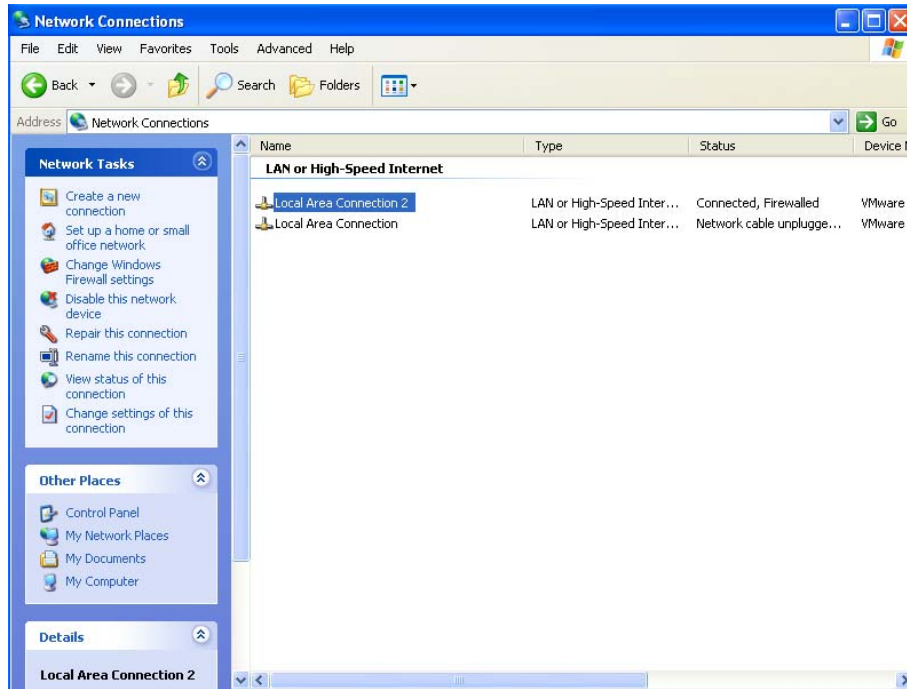

2. You will see the “Local Area Connection 2 Status” window. Click “Properties”.

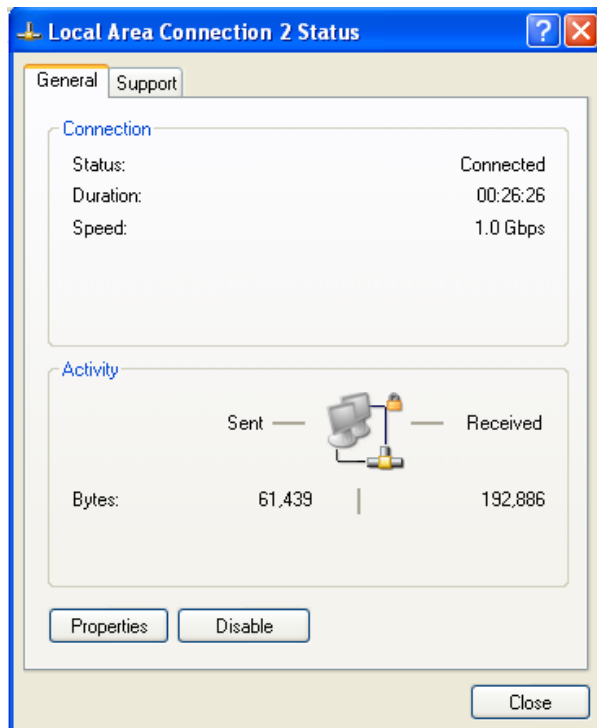

3. Click “Internet Protocol (TCP/IP)”.

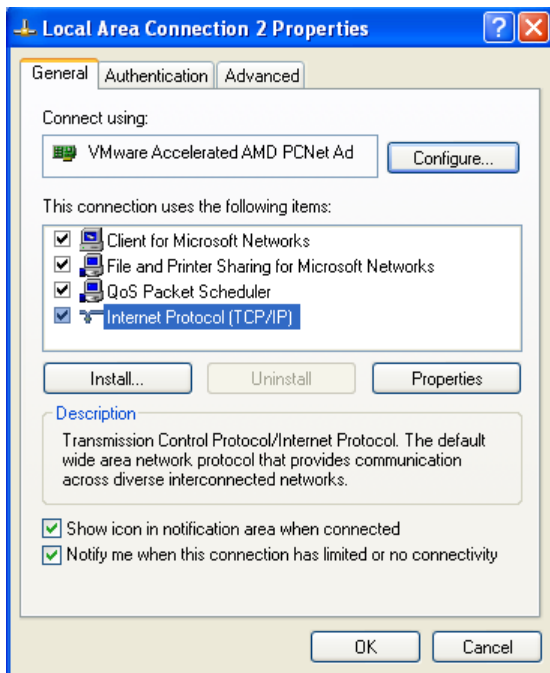

4. Enter “192.168.0.1” into IP address. Click “OK” to complete the IP address setting of the PC.

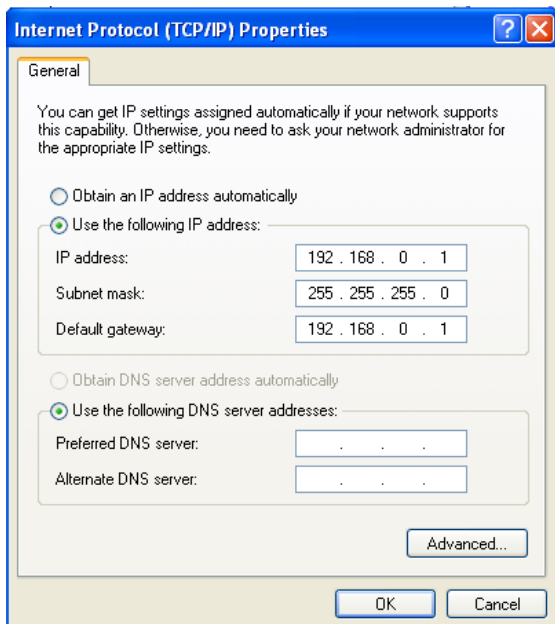

7.4 Alarm Setting

E-Mail is the abbreviation of electronic mail which transmits mails in a network. CMC-EIP01 has e-mail functions, and the user is able to self-define triggering conditions. When the condition to trigger e-mail is true, CMC-EIP01 will send an e-mail to the e-mail address set by the user.

The triggering condition is the change of value in a certain register of VFD-C2000. Once the set value is achieved, the action set for the command will be executed, and an e-mail will be sent to designated e-mail address.

■ Alarm Setting

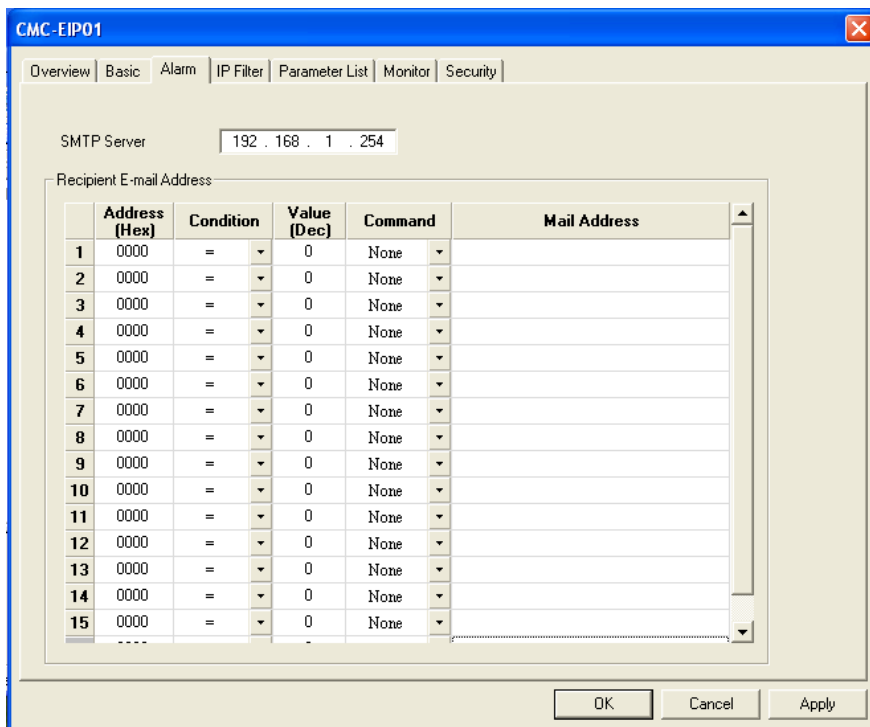

1. SMTP Server:

The e-mail will first be sent to the SMTP server, and the SMTP server will send it to the designated address. For example, assume there is an e-mail to be sent to Test@delta.com.tw, and the SMTP server is at IP 192.168.1.254, the e-mail will be sent to the SMTP server first, and the SMTP server will further send it to Test@delta.com.tw.

2. Recipient E-mail Address:

Setting up conditions

(1) Address (Hex)

Address of register (parameter) in VFD-C2000

(2) Condition

=, >, <, >=, <=, or <>

(3) Value (Dec)

A decimal value

(4) Command

When the triggering condition is true, the action set in Command will be executed.

CMC-EIP01 executes “Free Run”, “Quick Stop” and “Stop” to VFD-C2000.

(5) Mail address

The recipient address of the e-mail to be sent (max. 63 English characters)

Note:

To correctly send out e-mails, there has to be an SMTP server on the network. When we send out an e-mail, the mail will be sent to the SMTP server first, and the server will further send the mail to the designated address.

7.5 IP Filter

The IP filter is used for restricting the connection of the network in case some uncertain IP will cause errors. Only the IP set within the allowed range can establish the connection; other IPs will be rejected.

■ Setting up IP filter

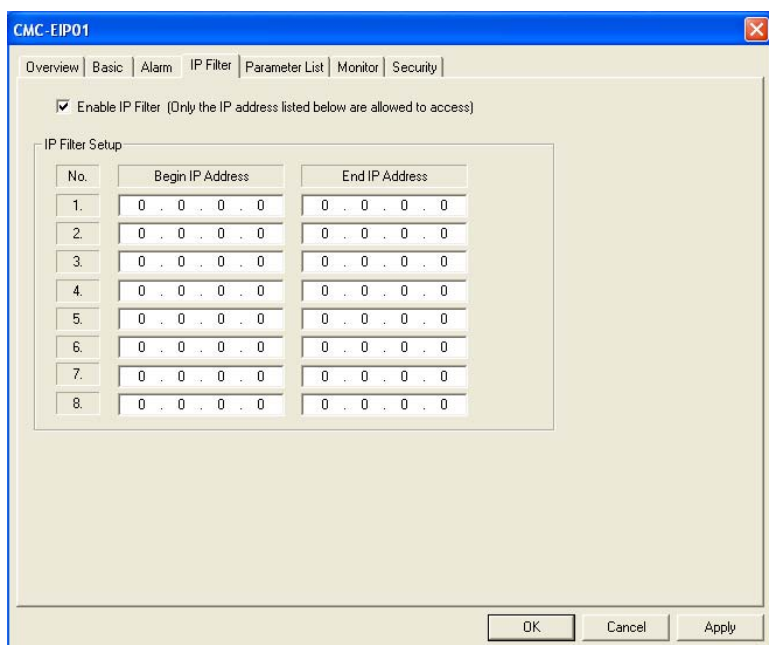

1. Enable IP Filter:

Check the box to enable IP filter.

2. Begin IP Address:

The beginning IP addresses that are allowed to establish a connection. Max. 8 IPs are allowed.

3. End IP Address:

The ending IP addresses that are allowed to establish a connection. Max. 8 IPs are allowed.

7.6 Parameter List

The VFD-C2000 parameter numbers, Modbus addresses, register names, units, present values, default values, minimum values, maximum values, and attributes are listed for group 0~group 11 in the parameter list. Check a parameter on the parameter page to display it on the monitoring page and monitor it.

■ Setting up parameter list

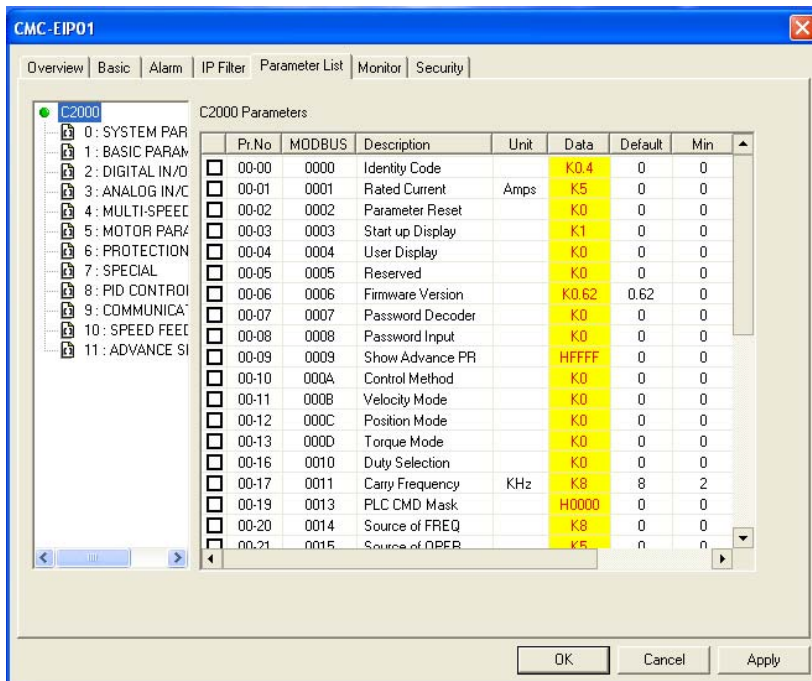

1. :

Check the parameter in VFD-C2000 to be monitored. You can check max. 100 parameters. Click “Apply” and save it.

Note:

- (1) Check the box to display the parameter in the monitoring page, but you still need to click “Apply” to save it; otherwise it will return to the previous setting when you leave the page and re-enter it.
- (2) Consecutive parameters can be seen as one group. Max. 16 groups (total 100 data) can be monitored at a time.

7.7 Monitor

The values of the VFD-C2000 parameters in the monitoring table can be constantly read, and saved in CMC-EIP01. If the values are read through the network, the flash memory will respond directly, enhancing the reading efficiency. In addition, this page can also be used to monitor the present values set in the parameters of VFD-C2000 on-line.

■ Setting up monitoring

	Address (Hex)	Address (Dec)	Account	Address (Hex)	Address (Dec)	Data	Digit Selection
1				1			Hex
2				2			Hex
3				3			Hex
4				4			Hex
5				5			Hex
6				6			Hex
7				7			Hex
8				8			Hex
9				9			Hex
10				10			Hex
11				11			Hex
12				12			Hex
13				13			Hex
14				14			Hex
15				15			Hex
16				16			Hex
17				17			Hex
18				18			Hex

The monitoring function will be automatically enabled when “Account” > 1. The monitoring function can be executed no matter on-line monitoring (start/end monitoring) is executed or not.

1. Address (Hex): Enter a four-digit hex (0000 ~ FFFF) address in this column, and its corresponding decimal address will be automatically calculated when you shift to Address (Dec) column.
2. Address (Dec): Enter a six-digit decimal address (400001 ~ 465536) in this column, and its corresponding hex address will be automatically calculated when you shift to Address (Hex) column.
3. Account: The number of data to be monitored. The number in every row represents the consecutive number of data monitored. Max. total: 100.
4. Digit Selection: Hex, Dec or Bin
5. Undo: To return to the previously saved settings.
6. Optimal: To integrate repeated and consecutive addresses in each group to a set of consecutive addresses.
7. Start/Stop Monitor: To start or stop on-line monitoring.

7.8 Security

After you set up all the functions and network environment for CMC-EIP01, to prevent the set values from being modified, you can set up passwords to lock the settings in CMC-EIP01.

■ Setting up password

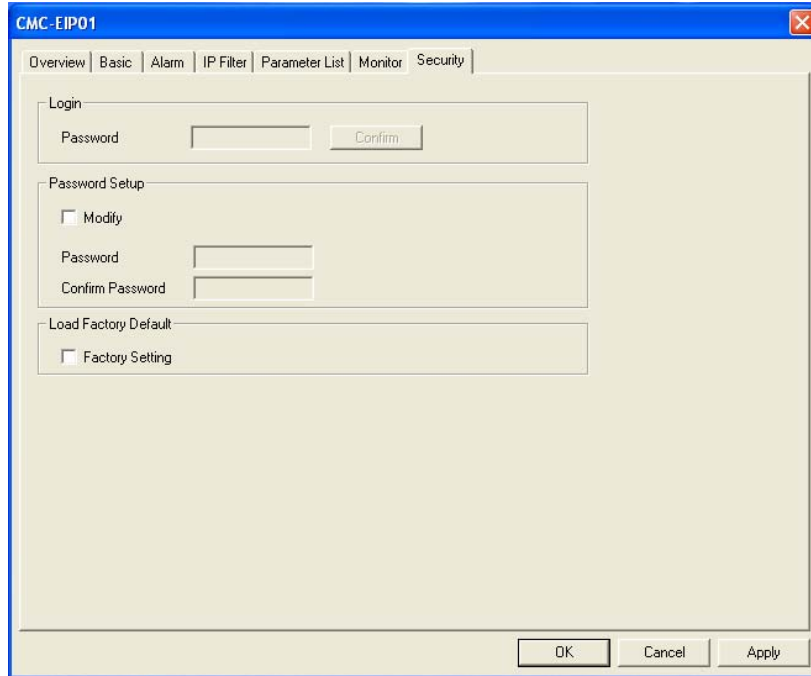

1. Password Setup:

Check the box to modify the password.

2. Password:

Max. 4 characters. Leave it blank to disable the password function.

3. Confirm password:

Enter the new password again.

Note:

Once the password is locked, all the pages cannot be set up unless you unlock the password. However, if you set up CMC-EIP01 by VFD-C2000 keypad and there is no password inside, you can only return to the default setting.

7.9 Returning to Default Settings

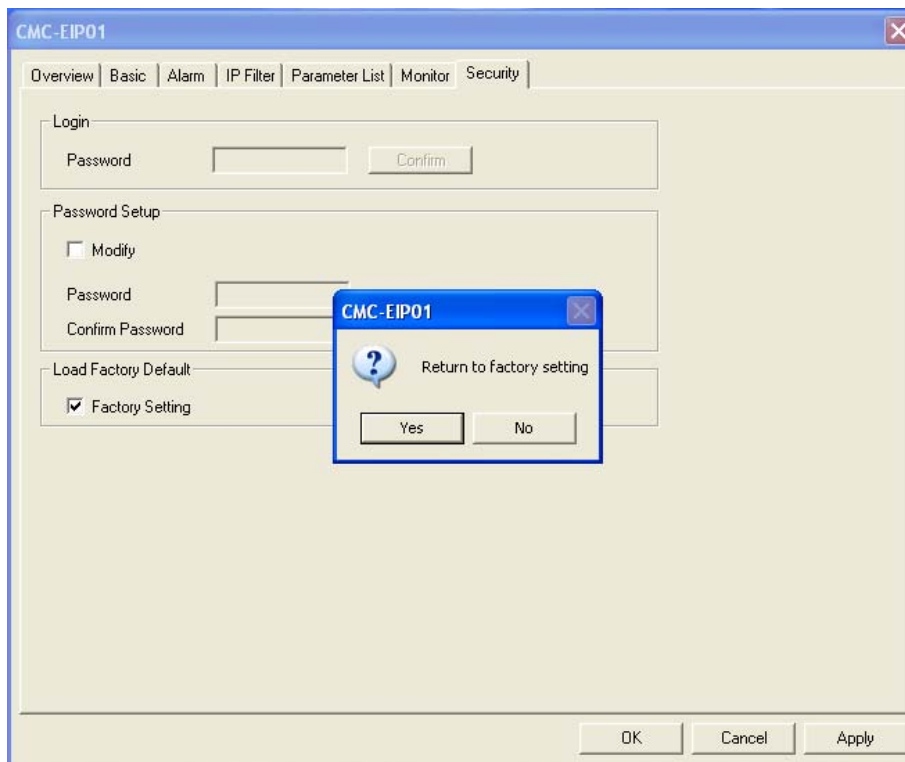

Check the “Factory Setting” box and click “Yes” to reset all the settings of CMC-EIP01 to default settings.

Note:

If you reset CMC-EIP01 to default setting by VFD-C2000 keypad, you can do it whether CMC-EIP01 is locked by a password or not, and please do not shut down the power supply during the process.

8 Application Examples

8.1 Write Frequency of VFD-C2000 by DVP-SV + DVPEN01-SL through Network (MODBUS TCP)

Application	Writing 60Hz frequency into VFD-C2000 (parameter address: H'2001, 60Hz = H'1770) by PLC through Ethernet
Steps	(1) IP of Ethernet module DVPEN01-SL: 192.168.1.10 (2) IP of CMC-EIP01: 192.168.1.15. Station No.: 2 (3) Delta PLC DVP-SV sends out MODBUS command "06020620011770" to VFD-C2000 through DVPEN01-SL.

1. The connection:

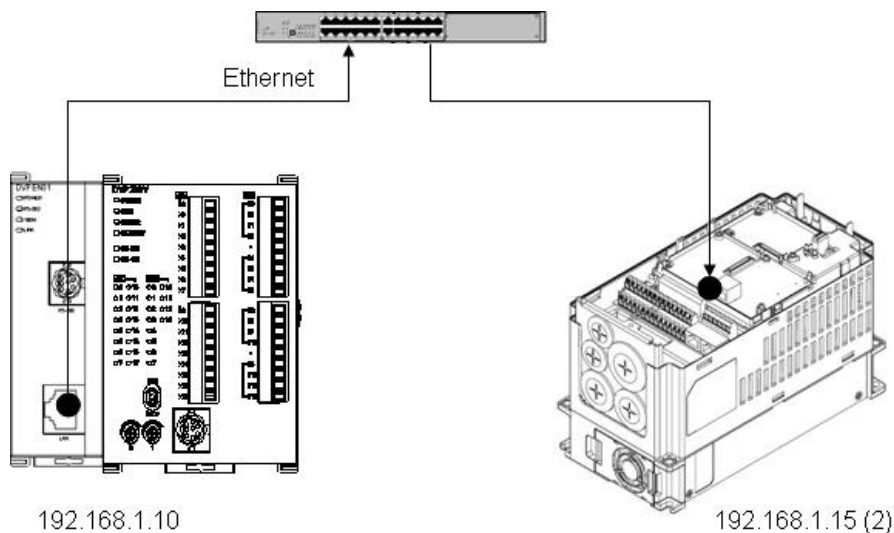

2. PLC program:

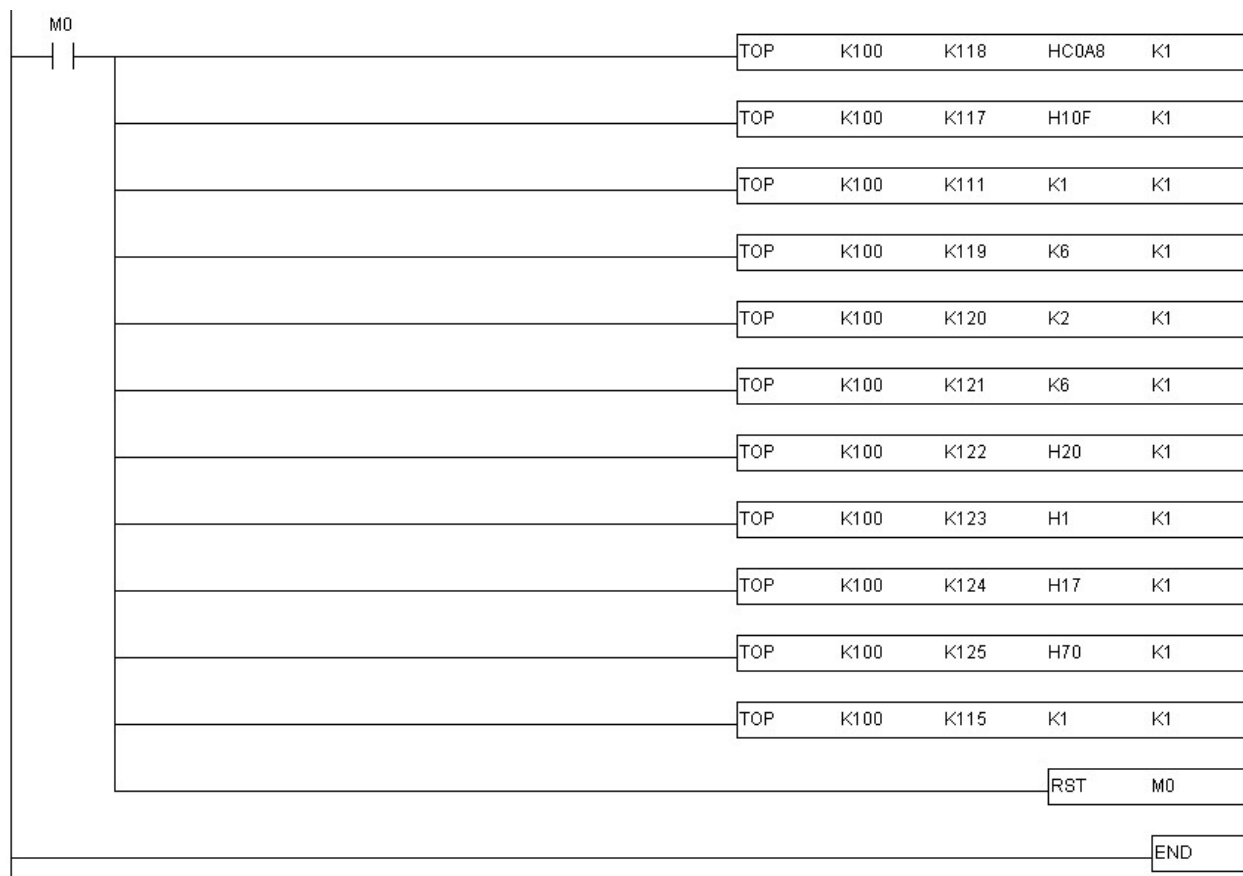

Program explanations:

1. Write the IP of CMC-EIP01 into CR#117 (「1.15」 = H'010F) and CR#118 (「192.168」 = H'C0A8) of DVPEN01-SL.
2. Set CR#111 = 1 and use 8-bit mode.
3. Write the length of command into CR#119.
4. Write MODBUS command "06020620011770" into CR#120 ~ CR#125, in which CR#120 is for the MODBUS station No.
5. Write 1 into CR#115 to start executing MODBUS TCP command.
6. Download the program to Delta DVP-SV PLC. Enable M0 to send MODBUS command "06020620011770" to VFD-C2000, setting the frequency to 60Hz.

Please refer to "DVPEN01-SL Operation Manual" for relevant settings of DVPEN01-SL.

8.2 Monitor VFD-C2000 Parameters On-Line through DCISoft/Web

Application	Using DCISoft to monitor VFD-C2000 parameters
Steps	(1) IP of PC: 192.168.1.30 (2) IP of CMC-EIP01: 192.168.1.20

1. The connection:

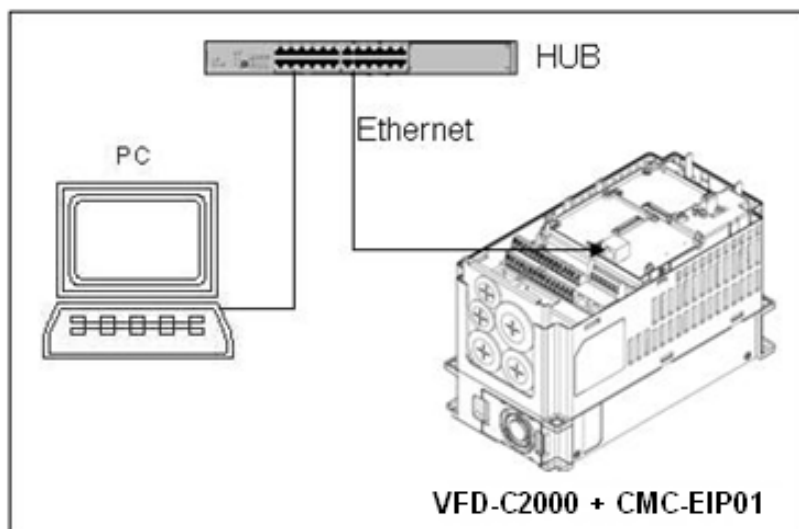

2. Open DCISoft's "Search" function (if in different LAN, search by designated IP) to search for CMC-EIP01.

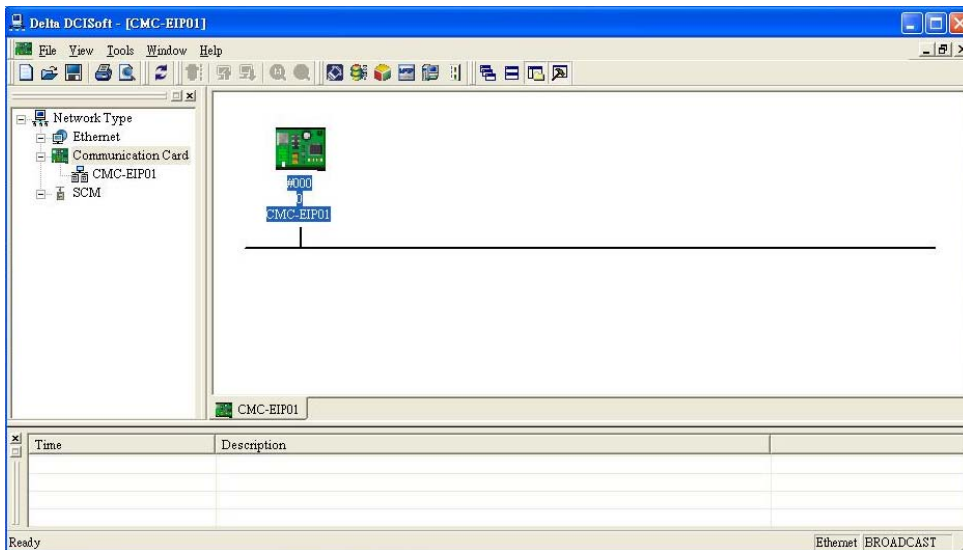

3. Enter "Parameter List" page and check the VFD-C2000 parameters to be monitored.
4. Assume you want to monitor parameters 00-01, 01-01, 02-01, 03-01, 04-01, 05-01 and 06-01, check them on the parameter list.
5. Switch to monitor page and the checked items will be displayed on the monitor list.
6. Click "Apply" to automatically execute the monitoring function in DCISoft.

8.3 Set up and Clear Password

Application	Using DCISoft to set up and clear the password in CMC-EIP01
Steps	(1) Set up password in CMC-EIP01. (2) Unlock CMC-EIP01. (3) Clear password in CMC-EIP01.

1. See 7.1 for the connection and communication settings.
2. Open the setup pages for CMC-EIP01 and switch to “Security” page.

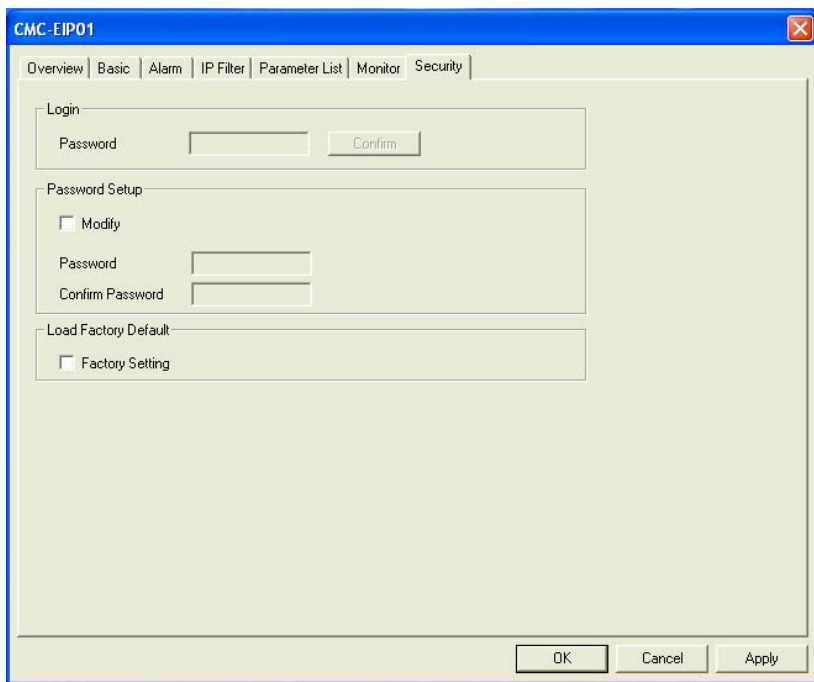

3. Check “Modify” and enter password “1234” into the “Password” and “Confirm Password” columns. Click “Apply” to save the password.

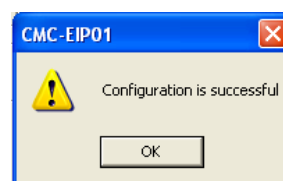
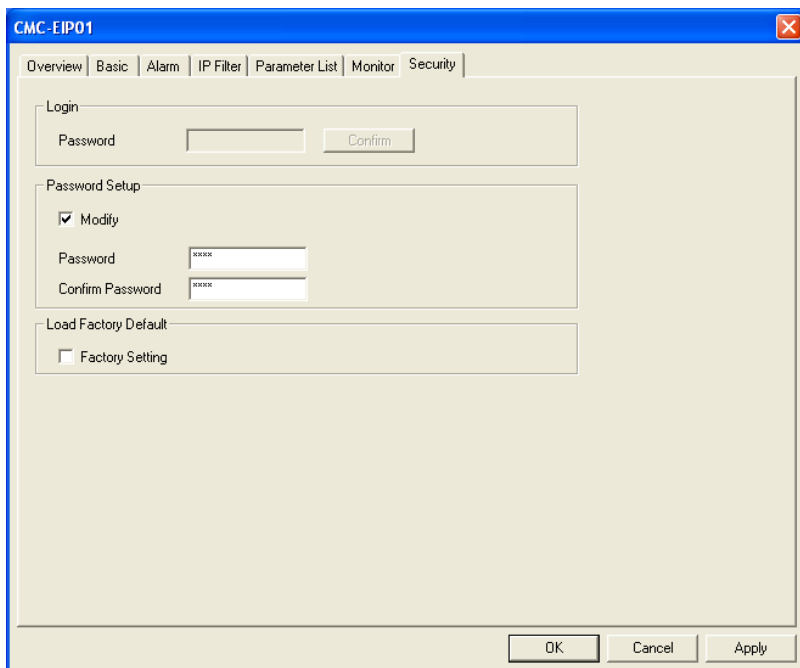

4. Reopen the setup page, and all the settings are now locked by password. Enter the password and click “OK”.

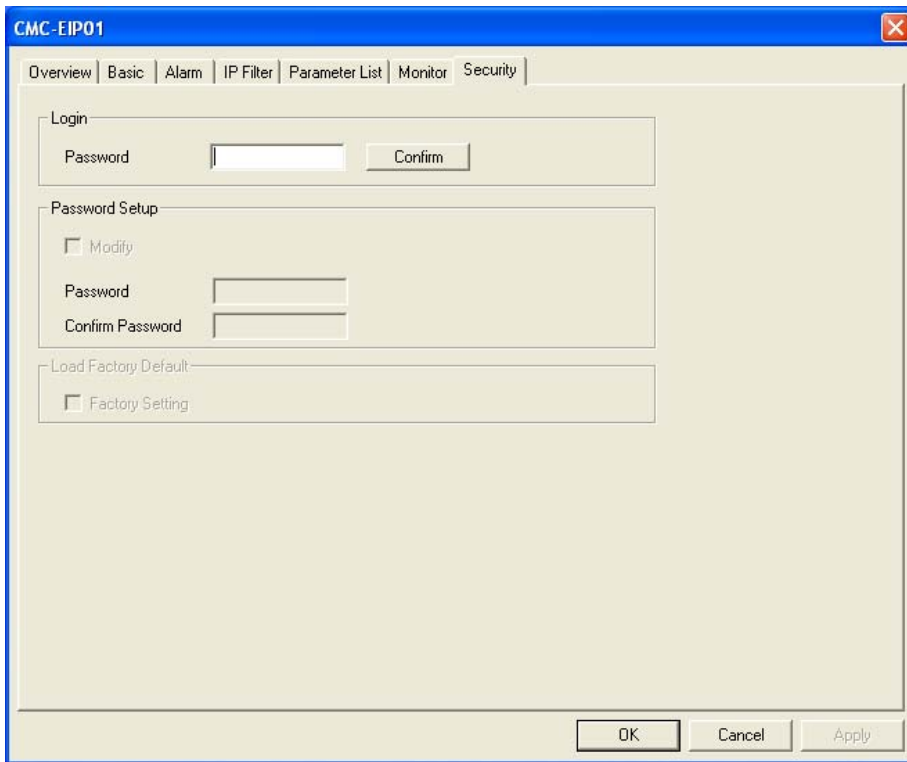

The screenshot shows the 'Security' tab of the CMC-EIP01 configuration window. It contains three sections: 'Login' with a 'Password' field and a 'Confirm' button; 'Password Setup' with a 'Modify' checkbox, a 'Password' field, and a 'Confirm Password' field; and 'Load Factory Default' with a 'Factory Setting' checkbox. At the bottom, there are 'OK', 'Cancel', and 'Apply' buttons.

5. Enter the password to unlock the settings and modify parameters. If you close the setup page now, the settings will remain being locked.

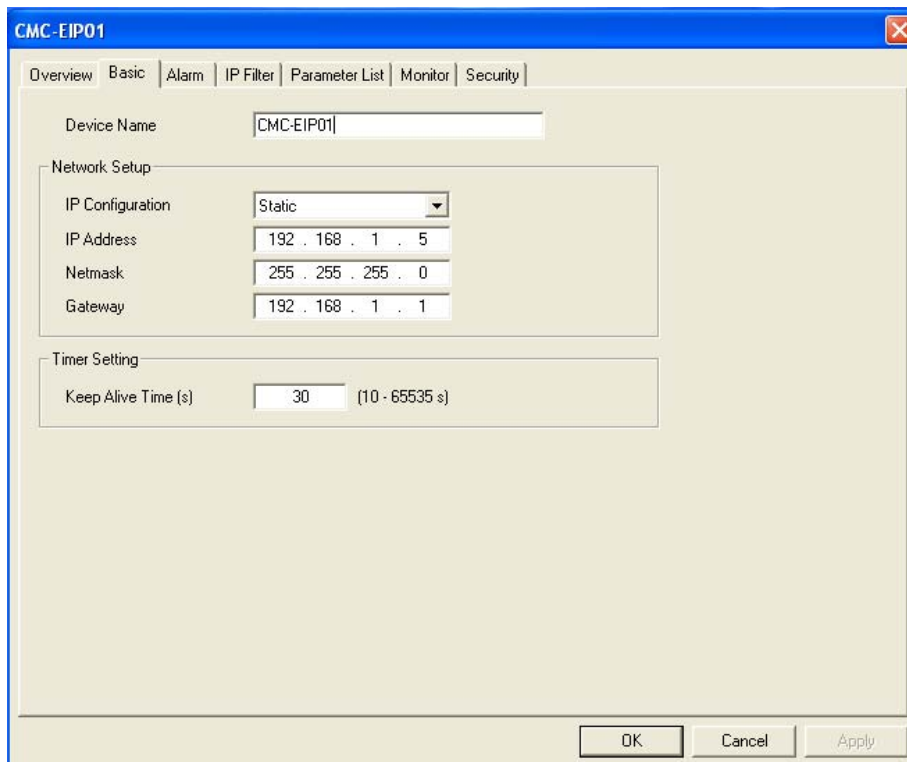

The screenshot shows the 'Basic' tab of the CMC-EIP01 configuration window. It contains a 'Device Name' field with the value 'CMC-EIP01'. Below it is the 'Network Setup' section with a dropdown for 'IP Configuration' set to 'Static', and three input fields for 'IP Address' (192 . 168 . 1 . 5), 'Netmask' (255 . 255 . 255 . 0), and 'Gateway' (192 . 168 . 1 . 1). The 'Timer Setting' section has a 'Keep Alive Time (s)' field set to '30' with a range '(10 - 65535 s)'. At the bottom, there are 'OK', 'Cancel', and 'Apply' buttons.

6. To clear the password, leave the password columns blank and click “Apply”.

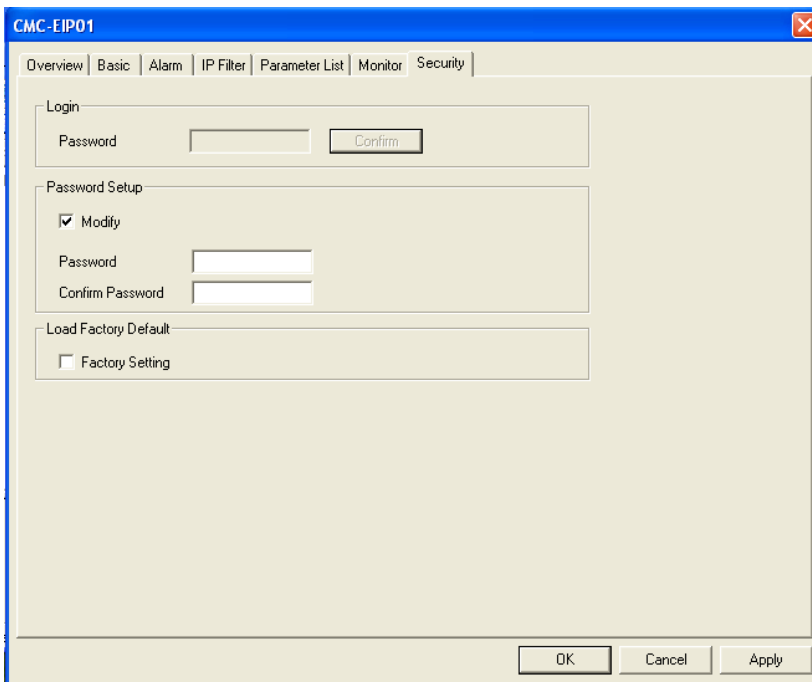

The screenshot shows the 'Security' tab of the CMC-EIP01 configuration window. It features three sections: 'Login' with a 'Password' field and a 'Confirm' button; 'Password Setup' with a checked 'Modify' checkbox, a 'Password' field, and a 'Confirm Password' field; and 'Load Factory Default' with an unchecked 'Factory Setting' checkbox. At the bottom, there are 'OK', 'Cancel', and 'Apply' buttons.

7. After the password is cleared, you can then modify parameters.

8.4 IP Filter Protection

Application	Setting up IP filter protection
Steps	(1) IP of CMC-EIP01: 192.168.0.4 (2) Only allow 192.168.0.7 and 172.16.0.1~172.16.0.254 to establish connections with CMC-EIP01.

1. See 7.1 for the connection and communication settings.
2. Open the setup page for CMC-EIP01 and switch to “IP Filter” page.

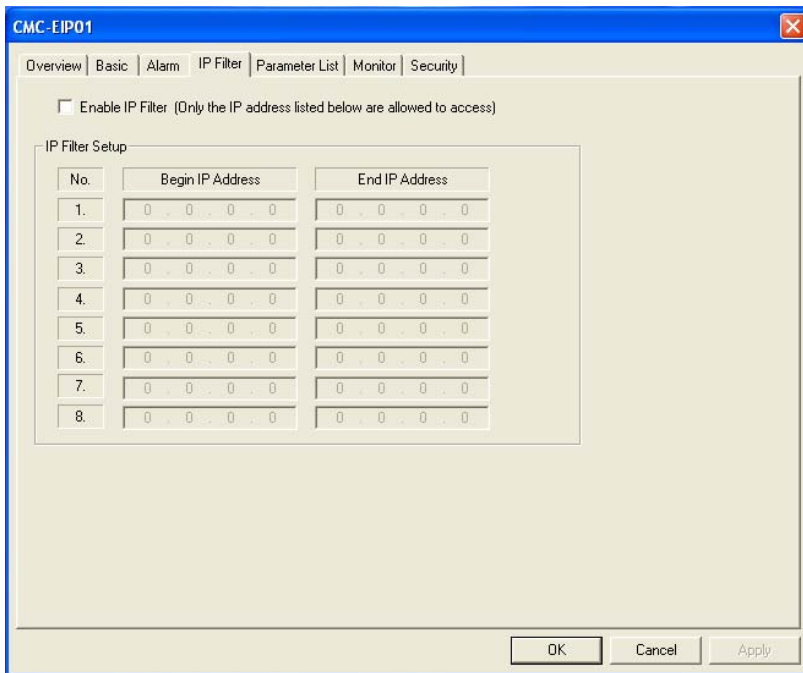

3. Check “Enable IP Filter”. Enter “192.168.0.7” in No. 1 Begin IP Address and “192.168.0.7” in End IP Address.

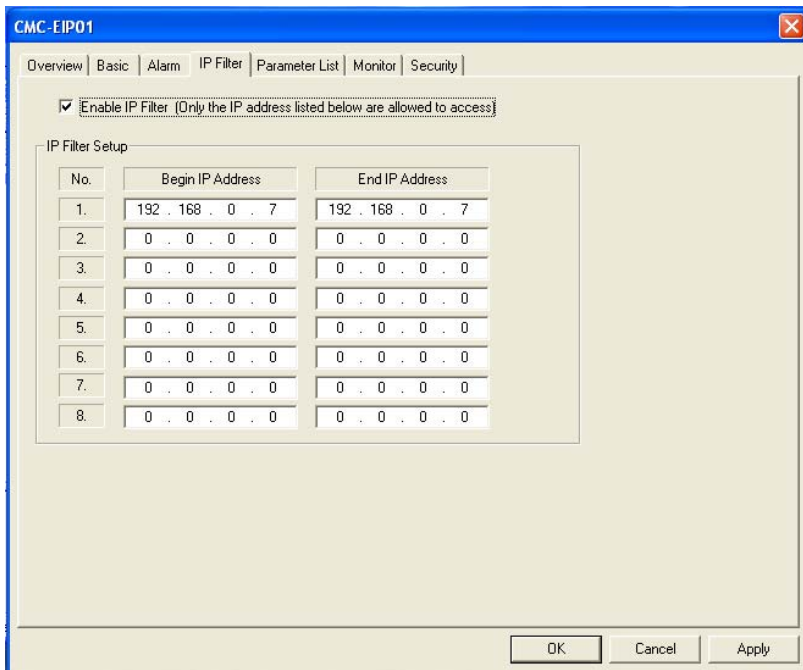

4. Enter “172.16.0.1” in No.2 Begin IP Address and “172.16.0.254” in End IP Address. Click “Apply”, then only equipment within the allowed IP range can be connected.

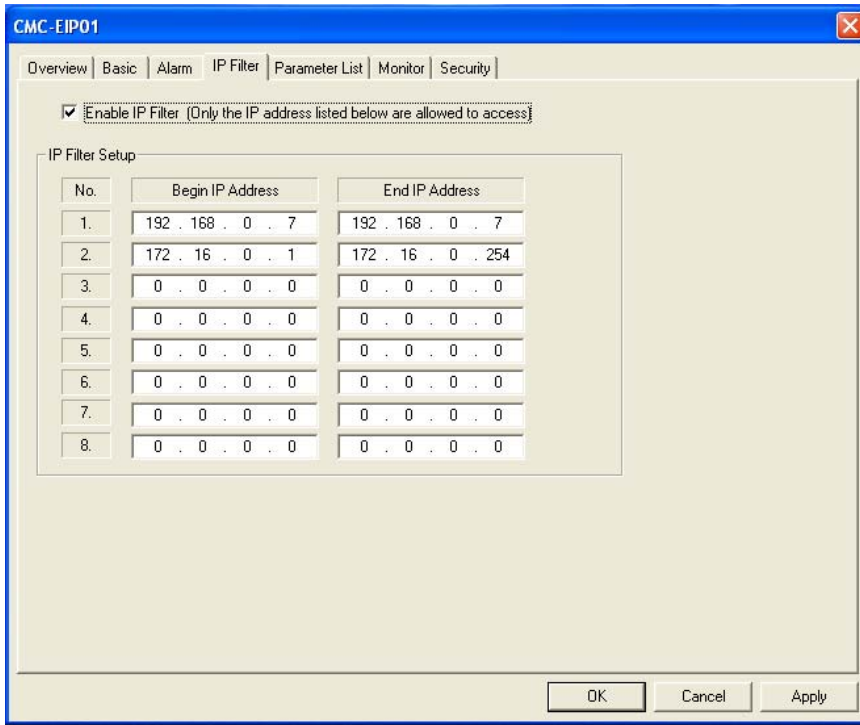

8.5 E-Mail

Application	When the value in Address (Hex) = Value (Dec), CMC-EIP01 will make VFD-C2000 execute the command and send e-mail to notify the administrator.
Steps	<ol style="list-style-type: none"> (1) IP of SMTP Server: 172.16.144.122 (2) Administrator's e-mail address: test@sample.com (3) When H'2103 = 60, execute "STOP" and send e-mail to designated address.

1. See 7.1 for the connection and communication settings.
2. Open the setup page for CMC-EIP01 and switch to "Alarm" page.

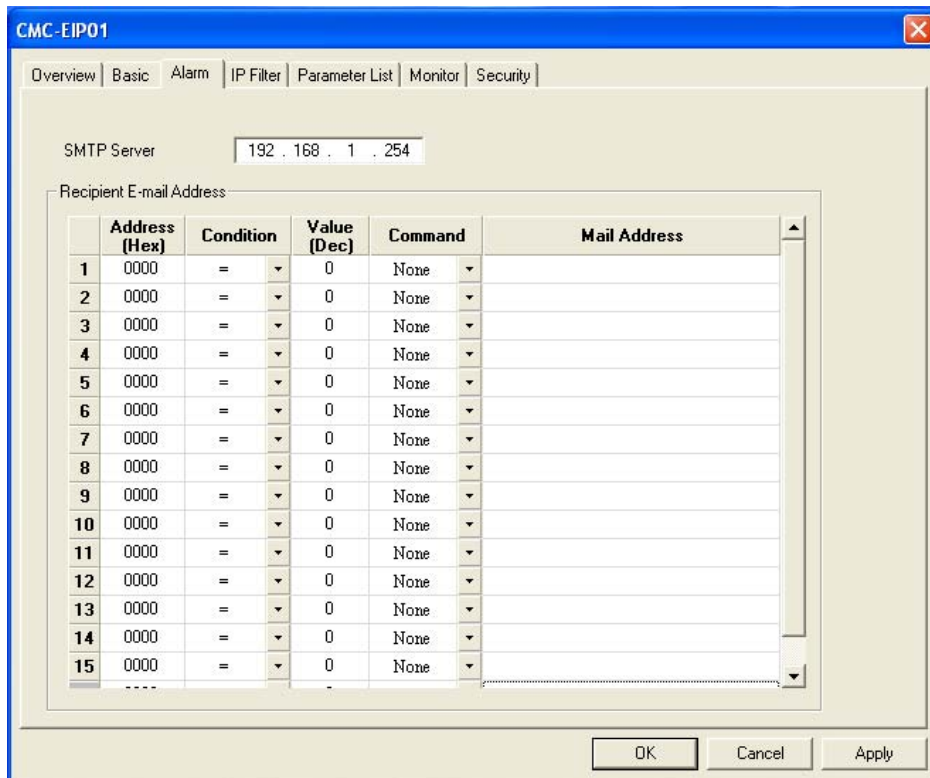

3. Set up e-mail and trigger event. Enter "172.16.144.122" in SMTP Server. Enter "2103" in Address (Hex) in the first row, "=" in Condition, "60" in Value (Dec), "Stop" in Command and "test@sample.com" in Mail Address. Click "Apply" to complete the alarm setting.

CMC-EIP01

Overview | Basic | Alarm | IP Filter | Parameter List | Monitor | Security

SMTP Server: 172 . 16 . 144 . 122

Recipient E-mail Address

	Address (Hex)	Condition	Value (Dec)	Command	Mail Address
1	2103	=	60	Stop	test@sample.com
2	0000	=	0	None	
3	0000	=	0	None	
4	0000	=	0	None	
5	0000	=	0	None	
6	0000	=	0	None	
7	0000	=	0	None	
8	0000	=	0	None	
9	0000	=	0	None	
10	0000	=	0	None	
11	0000	=	0	None	
12	0000	=	0	None	
13	0000	=	0	None	
14	0000	=	0	None	
15	0000	=	0	None	

OK Cancel Apply

8.6 Keypad Operation (1)

Application	Setting up network parameter by keypad
Steps	(1) Set Static IP to "192.168.1.16", Netmask "255.255.255.0" and Gateway "192.168.1.1". (2) Set up IP to DHCP.

■ Static

1. Enter the corresponding value in every address by keypad according to the table below.
Press "Enter" on the keypad to complete the setup.

Address	Value	Function
09-75	0	Set the IP to "Static"
09-76	192	IP Address 1
09-77	168	IP Address 2
09-78	1	IP Address 3
09-79	16	IP Address 4
09-80	255	Net Mask 1
09-81	255	Net Mask 2
09-82	255	Net Mask 3
09-83	255	Net Mask 4
09-84	192	Gateway 1
09-85	168	Gateway 2
09-86	1	Gateway 3
09-87	1	Gateway 4

2. Enter "2" into address 09-91 by keypad and press "Enter" on the keypad to complete the network parameter setup.

■ DHCP

1. Enter "1" into address 09-75 to set the IP to DHCP, then enter "2" into address 09-91.
Press "Enter" on the keypad to complete the setup.

8.7 Keypad Operation (2)

Application	Modifying network parameters by keypad under password protection.
Steps	(1) The password in CMC-EIP01: 1234 (2) Set Static IP to "192.168.1.16", Netmask "255.255.255.0" and Gateway "192.168.1.1".

1. See 7.8 for how to set up password in CMC-EIP01.
2. Re-open the setup page, and it is locked by the password. No settings can be modified, nor returning to default settings.

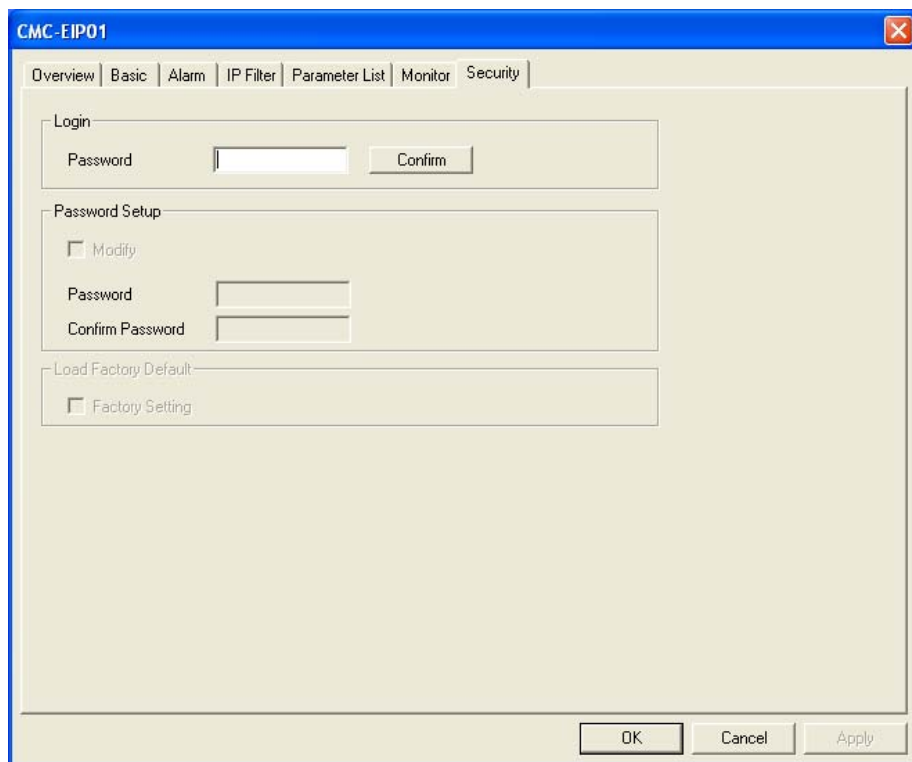

3. Enter the corresponding value in every address by keypad according to the table below. Press “Enter” on the keypad to complete the setup.

Address	Value	Function
09-75	0	Set the IP to “Static”
09-76	192	IP Address 1
09-77	168	IP Address 2
09-78	1	IP Address 3
09-79	16	IP Address 4
09-80	255	Netmask 1
09-81	255	Netmask 2
09-82	255	Netmask 3
09-83	0	Netmask 4
09-84	192	Gateway 1
09-85	168	Gateway 2
09-86	1	Gateway 3
09-87	1	Gateway 4
09-88	34	Password Low
09-89	12	Passwrod High

4. Enter “6” into address 09-91 by keypad and press “Enter” on the keypad to complete the network parameter setup.

Note:

Operating password by keypad only allow you to login and modify the parameter. You cannot setup or change the password on the keypad.

8.8 Keypad Operation (3)

Application	Using keypad to return to default setting when the password is lost.
Steps	(1) Set up password in CMC-EIP01. (2) The password is lost. Return to default settings by keypad.

1. See 7.8 for how to set up password in CMC-EIP01.
2. Re-open the setup page, and it is locked by the password. No settings can be modified, nor returning to default settings.

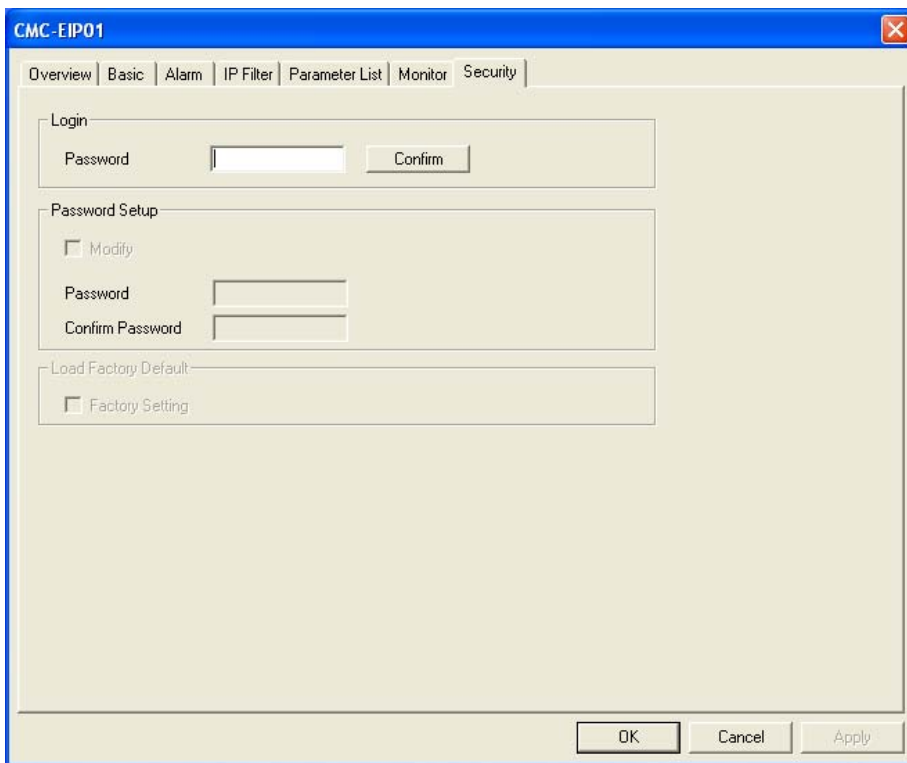

3. Enter "1" into address 09-90 by keypad.
4. Re-open the setup page in DCISoft. The password is now cleared and all settings returned to default ones.

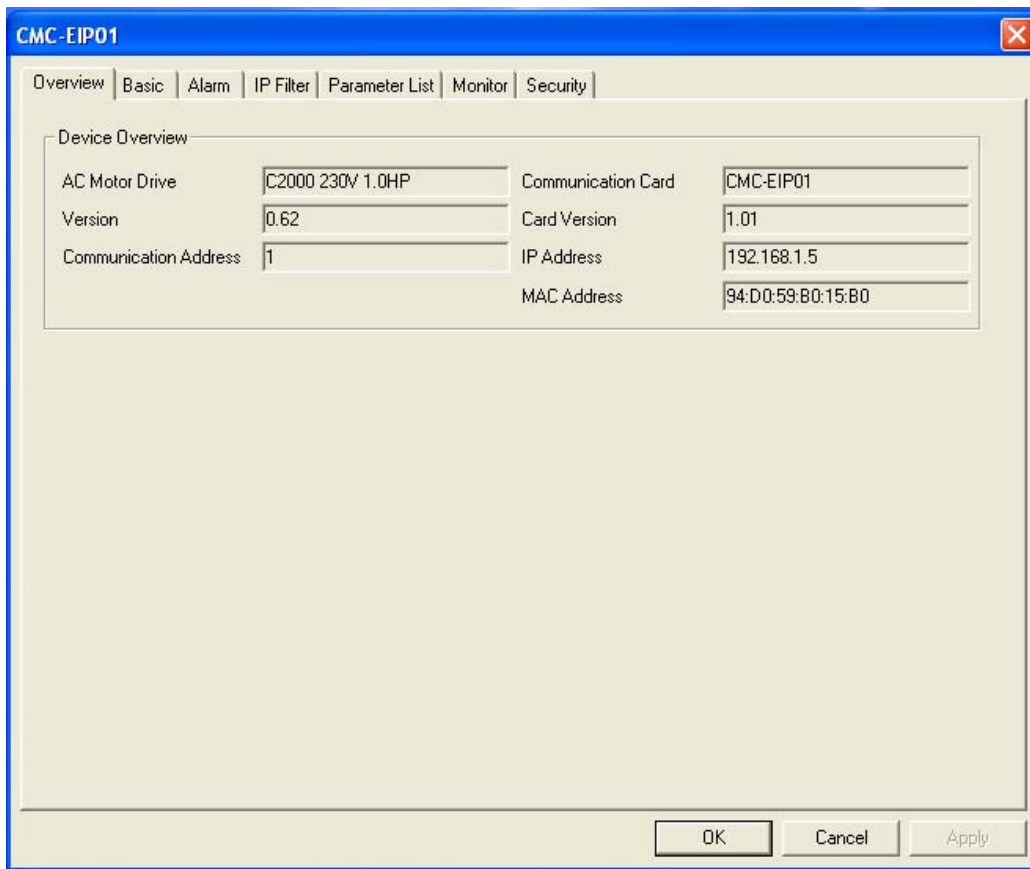

8.9 EtherNet/IP Application

Application	Using AB PLC 1769-L32E to control VFD-C2000 by CMC-EIP01
Steps	(1) IP of CMC-EIP01: 192.168.1.4 (2) IP of AB PLC 1769-L32E: 192.168.1.102

The connection:

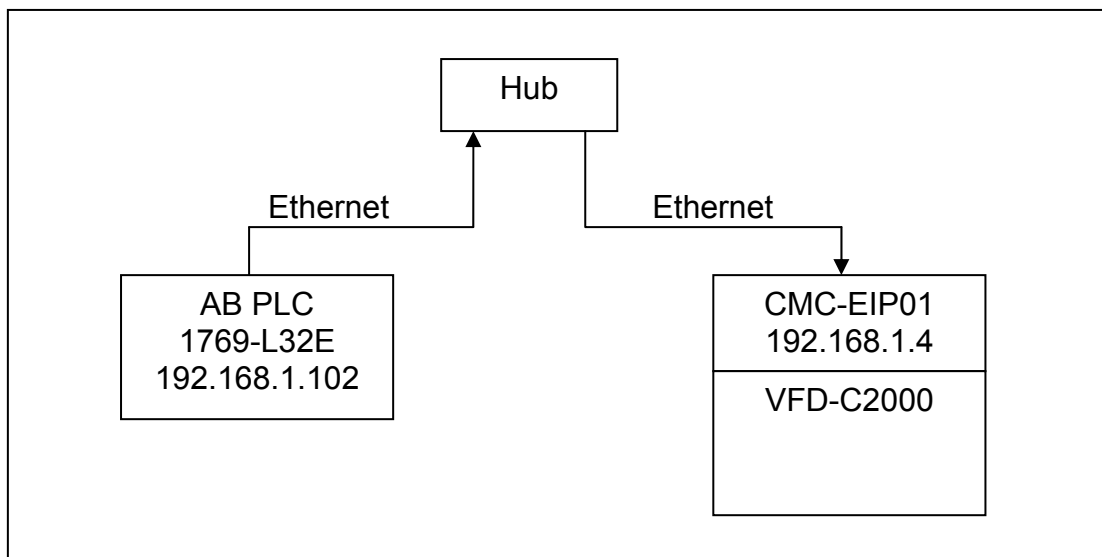

Setting up RSLogix 5000:

1. Select "New" to open a new controller.
2. Enter "1769-L32E" in the "Type" column as the name of the controller and click "OK" to complete the setting.
3. Add new Ethernet module (I/O Configuration→Backplan→1769-L32E Ethernet port→New Module).
4. Select "Communications" in the "Select Module" window.
5. Select "ETHERNET-MODULE" and click "OK" to complete the setting.
6. Enter the name of the module. Select "Data-INT" in the "Comm Format" column, enter "101" in "Assembly Instance", "16" in "Input Size", "100" in "Output Assembly Instance", "3" in "Output Size", "102" in "Configuration Assembly Instance", "0" in "Configuration Size" and "192.168.1.4" for "IP Address".
7. Go to Module Properties and set "Requested Packet Interval(RPI)" to "500.0" ms.
8. Open the MainRoutine page.
9. Create new tags "SW1", "SW2" and "SW3" (Use SW1, SW2 and SW3 to control the command ON/OFF).
10. Use Move instruction to move the data to "CMC_EIP01: O.Data" register.
 - (1) Set the frequency of VFD-C2000 to 60Hz: Move "6000" to CMC_EIP01: O.Data[1]
 - (2) Set VFD-C2000 to Run: Move "2" to CMC_EIP01: O.Data[0]
 - (3) Set VFD-C2000 to Stop: Move "1" to CMC_EIP01: O.Data[0]
11. Download the program and switch PLC 1769-L32E to be in on-line mode.
12. Set CMC-EIP01 to be the card controlling VFD-C2000. Refer to 3.3 for how to set.

13. Switch on "SW1" and set the frequency of VFD-C2000 to 60Hz.
14. Switch on "SW2" for VFD-C2000 to Run. Switch on "SW3" for VFD-C2000 to Stop.

Appendix A: EtherNet/IP Services and Objects

A.1 Objects Supported

Object	Class Code	Definition
Identity Object	0x01	For device identity
Message Router Object	0x02	For message route
Assembly Object	0x04	For assembly
Connection Manager Object	0x06	For connection management
BR Object	0x64	For basic control registers
AL Object	0x65	For alarm registers
MW Object	0x66	For monitoring
TCP/IP Interface Object	0xF5	For TCP/IP interface
Ethernet Link Object	0xF6	For Ethernet connection

A.2 Data Formates Supported

Data format	Explanation
BYTE	8-bit string
WORD	16-bit string
DWORD	32-bit string
STRING[n]	String composed of n bytes
SHORT_STRING	String combined from bytes (1 byte length indicator, 1 byte characters)
USINT	8-bit unsigned integer
UINT	16-bit unsigned integer
UDINT	32-bit unsigned integer

A.3 Identity Object (Class Code: 0x01)

A.3.1 Instance Code: 0x01

A.3.2 Instance Attributes

Attribute ID	Access rule	Name	Data type	Description of attribute
0x01	Get	Vendor ID	UINT	799
0x02	Get	Device Type	UINT	Communications Adapter 12
0x03	Get	Product Code	UINT	Model code: 0x0204
0x04	Get	Revision	STRUCT of: USINT, USINT	Firmware version Major revision Minor revision
0x05	Get	Status	WORD	Summary status of devices The value is always 0.
0x06	Get	Serial Number	UDINT	32-bit serial number of device
0x07	Get	Product Name	SHORT_STRING	CMC-EIP01

A.3.3 Common Services

Service code	Implemented for		Service name	Description of service
	Class	Instance		
0x05		✓	Reset	Resets device settings
0x0E		✓	Get Attribute Single	Sends back attribute of designated object

A.4 Message Router Object (Class Code: 0x02)

A.4.1 Instance Code: 0x01

A.4.2 Instance Attributes: None

A.4.3 Common Services

Service code	Implemented for		Service name	Description of service
	Class	Instance		
0x0E		✓	Get Attribute Single	Sends back attribute of designated object

A.5 Assembly Object (Class Code: 0x04)

A.5.1 Instance Code

Instance	Description
0x64	Corresponds to output buffer register
0x65	Corresponds to input buffer register
0x66	Corresponds to setup object

A.5.2 Instance Attributes

Attribute ID	Access Rule	Name	Data Type	Description of attribute
0x03	Get / Set	Data	ARRAY of BYTE	Instance Code = 0x64 (Get/Set) Others Get only

A.5.3 Common Services

Service code	Implemented for		Service name	Description of service
	Class	Instance		
0x0E		✓	Get Attribute Single	Sends back attribute of designated object
0x10		✓	Set Attribute Single	Modifies attribute

A.6 Connection Manager Object (Class Code: 0x06)

A.6.1 Instance Code: 0x01

A.6.2 Instance Attributes: None

A.6.3 Services

Service code	Implemented for		Service name	Description of service
	Class	Instance		
0x4E		✓	Forward Close	Shuts down the connection
0x54		✓	Forward Open	Establishes the connection, max. 511 bytes per transmission.

A.7 BR Object (Class Code: 0x64)

A.7.1 Instance Code

Instance	Description
0x01	Corresponds to BR0: Model name
0x02	Corresponds to BR1: Firmware version
0x03	Corresponds to BR2: Release date of the version
0x07	Corresponds to BR6: VFD-C2000 station No.
0x0C	Corresponds to BR11: MODBUS communication timeout
0x0E	Corresponds to BR13: Network keep alive time (TCP/IP)

A.7.2 Instance Attributes

Attribute ID	Access rule	Name	Data type	Description of attribute
0x03	Get / Set	Data	UINT	Refer to 4.2 for corresponding value Instance Code = 0x0E Get/Set Others Get Only

A.7.3 Common Services

Service code	Implemented for		Service name	Description of service
	Class	Instance		
0x0E		✓	Get Attribute Single	Sends back attribute of designated object
0x10		✓	Set Attribute Single	Modifies attribute

A.8 AL Object (Class Code: 0x65)

A.8.1 Instance Code

Instance	Description
0x01~0x10	Corresponds to AL0~AL15: Alarm register

A.8.2 Instance Attributes

Attribute ID	Access rule	Name	Data type	Description of attribute
0x03	Get	Data	UINT	Refer to 4.3 for corresponding value

A.8.3 Common Services

Service code	Implemented for		Service name	Description of service
	Class	Instance		
0x0E		✓	Get Attribute Single	Sends back attribute of designated object

A.9 MW Object (Class Code: 0x66)

A.9.1 Instance Code

Instance	Description
0x01	Corresponds to MW0: Monitor function
0x02~0x21	Corresponds to MW1 ~ MW32: Station No. And device address to be monitored
0x00CA~0x012D	Corresponds to MW201 ~ MW300: Value monitored
0x012E~0x0134	Corresponds to MW301 ~ MW307: Status monitored

A.9.2 Instance Attributes

Attribute ID	Access rule	Name	Data type	Description of attribute
0x03	Get / Set	Data	UINT	Refer to 4.6 for corresponding value. Instance Code = 0x02~0x21 Get/Set Others Get Only

A.9.3 Common Services

Service code	Implemented for		Service name	Description of service
	Class	Instance		
0x0E		✓	Get Attribute Single	Sends back attribute of designated object
0x10		✓	Set Attribute Single	Modifies attribute

A.10 TCP/IP Interface Object (Class Code: 0xF5)

A.10.1 Instance Code: 0x01

A.10.2 Instance Attributes

Attribute ID	Access rule	Name	Data type	Description of attribute
0x01	Get	Status	DWORD	Interface status
0x02	Get	Configuration Capability	DWORD	Interface capability flags
0x03	Get / Set	Configuration Control	DWORD	Interface control flags
0x04	Get	Path Size, Path	STRUCT of: UINT, Padded EPATH	Path size Path
0x05	Get / Set	Interface Configuration	STRUCT of: UDINT, UDINT, UDINT, UDINT, UDINT, STRING	IP Address Network Mask Gateway Address Name Server Name Server 2 Domain Name
0x06	Get / Set	Host Name	STRING	Host name

■ Status Instance Attribute

Bits	Name	Description
0-3	Interface Configuration Status	0 = The Interface Configuration attribute has not been configured. 1 = The Interface Configuration attribute contains valid configuration obtained from BOOTP, DHCP or non-volatile storage. 2 = The IP address member of the Interface Configuration attribute contains valid configuration, obtained from hardware settings (e.g.: pushwheel, thumbwheel, etc.) 3-15 = Reserved for future use.

■ Configuration Capability Attribute

Bits	Name	Description
2	DHCP Client	1 (TRUE) shall indicate the device is capable of obtaining its network configuration via DHCP.
4	Configuration Settable	1 (TRUE) shall indicate the Interface Configuration attribute is settable.

■ Configuration Control Attribute

Bits	Name	Description
0-3	Startup Configuration	0 = The device shall use the interface configuration values previously stored in non-volatile memory. 1 = The device shall obtain its interface configuration values via BOOTP. 2 = The device shall obtain its interface configuration values via DHCP upon start-up. 3-15 = Reserved for future use.

A.10.3 Common Services

Service Code	Implemented for		Service name	Description of service
	Class	Instance		
0x0E		✓	Get Attribute Single	Sends back attribute of designated object
0x10		✓	Set Attribute Single	Modifies attribute

A.11 Ethernet Link Object (Class Code: 0xF6)

A.11.1 Instance Code: 0x01

A.11.2 Instance Attributes

Attribute ID	Access rule	Name	Data type	Description of attribute
0x01	Get	Interface Speed	UDINT	Interface speed currently in use Speed in Mbps (e.g., 0, 10, 100, 1000, etc.)
0x02	Get	Interface Flags	DWORD	Interface status flags
0x03	Get	Physical Address	USINT[6]	MAC address

■ Interface Flags

Bits	Name	Description
0	Link Status	0 indicates an inactive link; 1 indicates an active link.
1	Half/Full Duplex	0 indicates the interface is running half duplex; 1 indicates full duplex.
2-4	Negotiation Status	Indicates the status of link auto-negotiation 0 = Auto-negotiation in progress. 1 = Auto-negotiation and speed detection failed. Using default values for speed and duplex. defaults are 10Mbps and half duplex. 2 = Auto negotiation failed but detected speed. default is half duplex. 3 = Successfully negotiated speed and duplex. 4 = Auto-negotiation not attempted. Forced speed and duplex.

A.11.3 Services

Service Code	Implemented for		Service name	Description of service
	Class	Instance		
0x0E		✓	Get Attribute Single	Sends back attribute of designated object