

Features

Open-structured CNC System

- Offers open structure for hardware and software, which allows customized integration, excellent flexibility and openness for a wide range of machine applications and industries
- Allows customers to choose different product combinations based on product features and market requirements with Delta's motion kernels and hardware structure

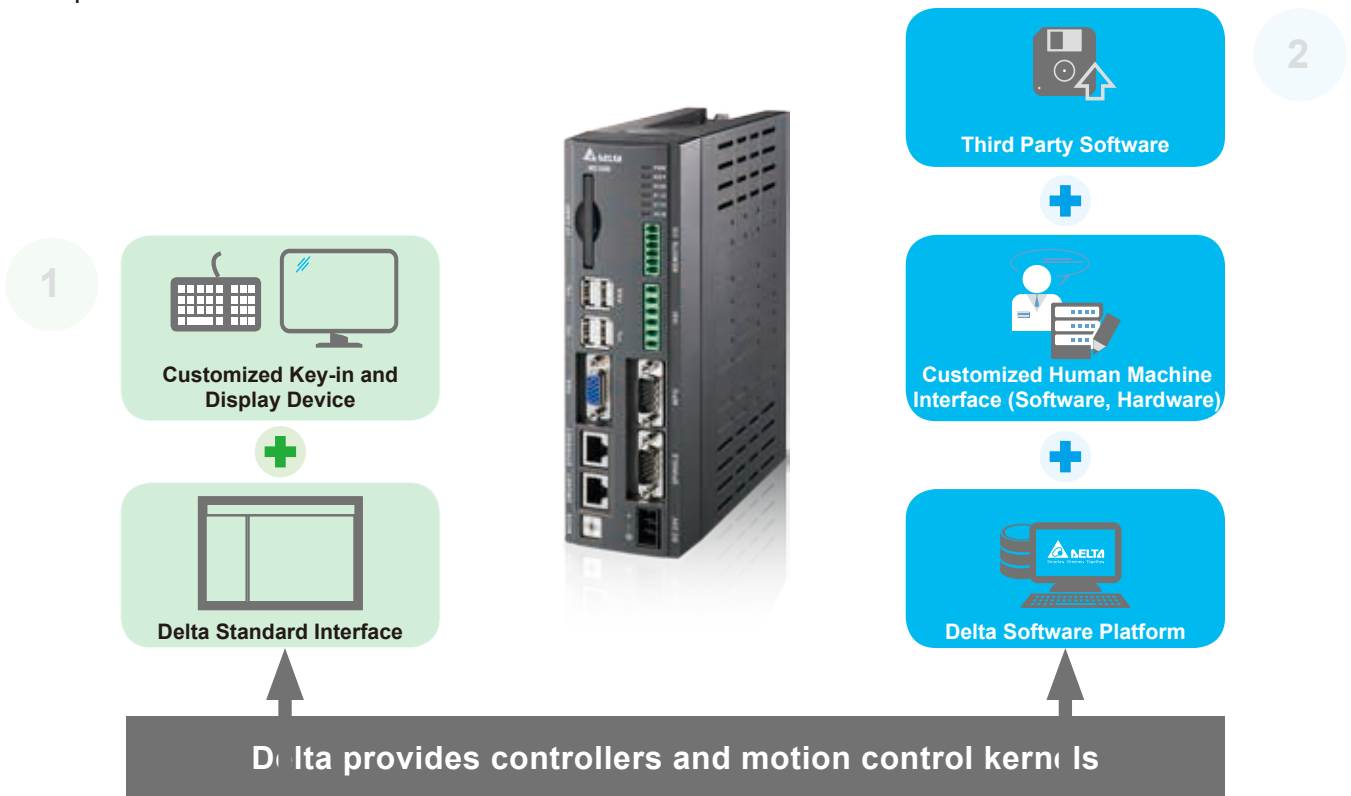

Application Programming Interface (API)

Supports the Application Programming Interface (API) that helps CNC machine makers, who might develop personal application software or combine with other value-added software, to customize the controller and integrate the information of the open CNC controller into their personal platform via Ethernet.

API Structure

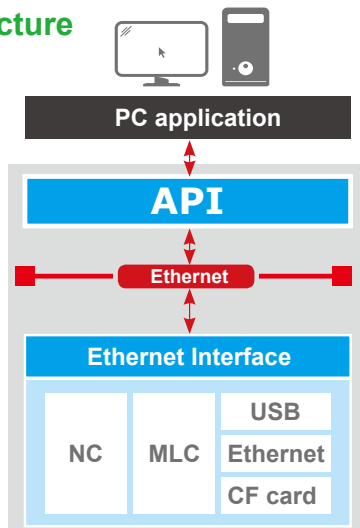

API Functions

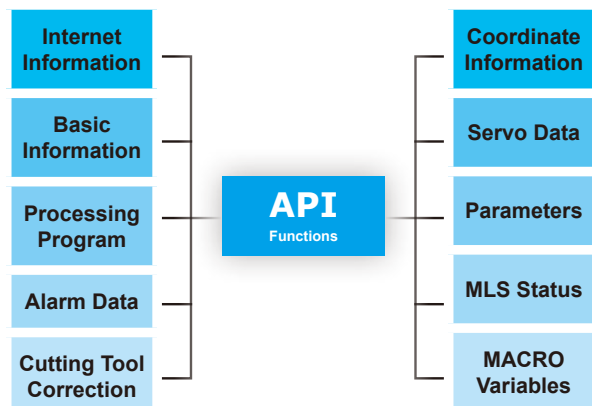

Flexible Interface

Built-in interface for operation display and functions allows customers to modify Delta's customized interface or develop self-defined interface to make machining operation more flexible and simpler

Standard Interface

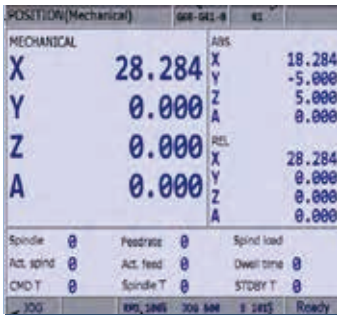

Customized Interface



- Pushbutton Setup
- Layout Color
- Font Size
- Content Arrangement

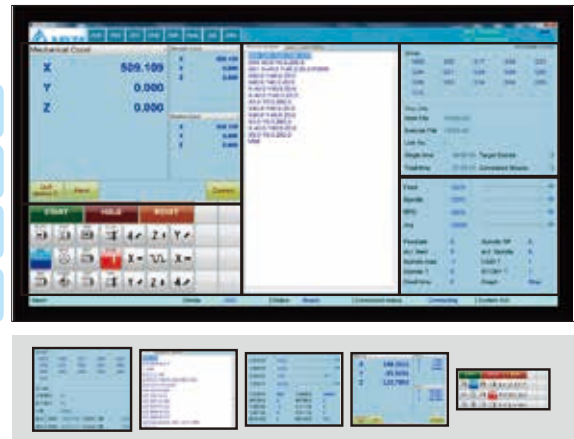

Specifications

Item	Specification
Maximum Number of Connected Computers	Permits 5 computers (the maximum) for simultaneous connections
Maximum Number of Socket Connections	Permits maximum of 10 simultaneous connections
DHCP	Available
VGA Resolution	Supports display resolution 800x600 (B series: 1,024 x 768)
USB Support Device	1 USB Disk 1 Mouse (only for software panel), supports touch screen 1 Keypad
Authority Management	Assigns authority for API reading, coding or both to different level of user groups (each connection has a separate authority)

Model Name



B Series:

- Adds 2 sets of I/O ports and 2nd OP port
- Supports Delta 2nd OP or 3rd party 2nd OP
- Adds 2 sets of DA and Pulse Output for twin spindle application

Model Name	Controlled Axes	Simultaneous Controlled Axes	Linear Interpolation	Circle Interpolation
NC30E	4 Axes	4	4	2
NC30E B	4 Axes	4	4	2
NC30E H	6 Axes	5	5	2
NC30E B H	6 Axes	5	5	2

System Configuration

Description

- OPEN CNC's customized platform structure offers a user-friendly interface
- Provides a smart platform and library for customers to self-define programs and conduct software development
- Reduces additional hardware cost for customers to focus more on software upgrades and better integrated operation performance

Solution 1: Standard

VGA output for external display with Delta's standard interface

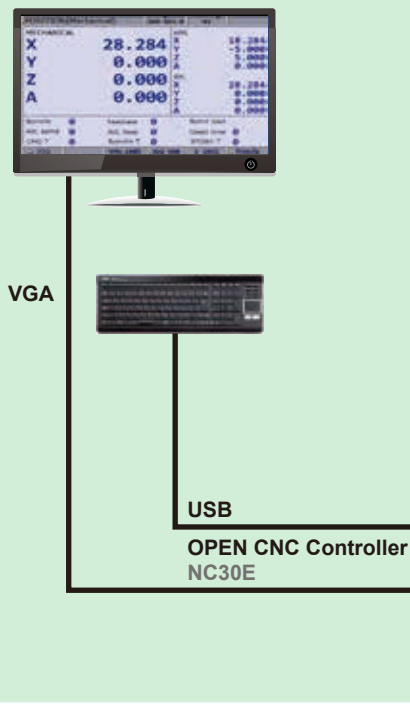

Solution 2: Function-Oriented

Customizable solution with different panel sizes for various applications

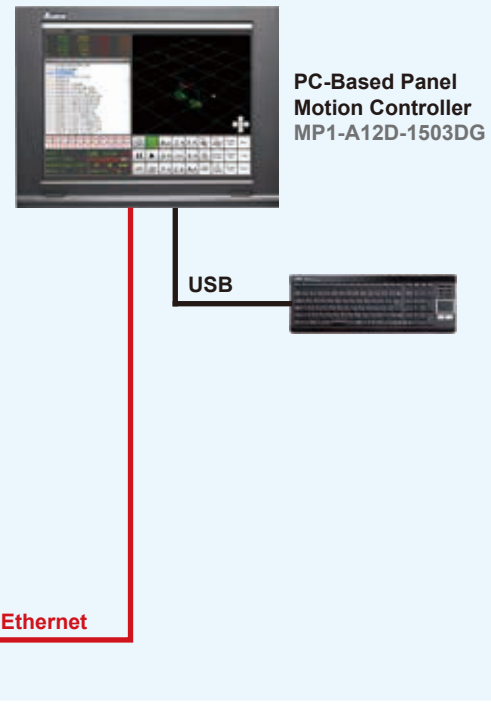

AC Servo Drives
ASDA-A2 Series

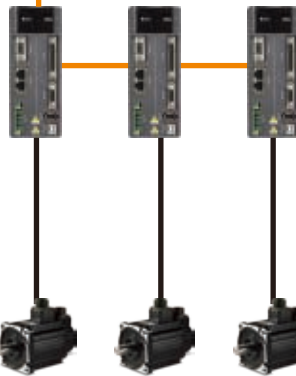

AC Servo Motors
ECMA Series



DMCNET





Spindle Motor Drive
ASDA-S

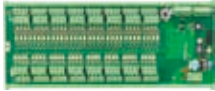
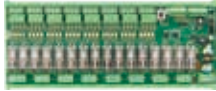

High Speed PM Spindle Motor
ECMS

Optional Accessories

High Speed Serial I/O			Other
Serial Cable	Photocoupler Type	Relay Type	HOP
 <ul style="list-style-type: none"> Provides 1.5 / 3.0 / 5.0 / 10 m Part No. 1.5m NC-CAB-EIO015 3.0m NC-CAB-EIO030 5.0m NC-CAB-EIO050 10m NC-CAB-EIO100X 	 <ul style="list-style-type: none"> Supports 32 Inputs/32 Outputs Part No. NC-EIO-T3232 Size: 286x121.78x 51.01 mm (Length x Width x Total Height) 	 <ul style="list-style-type: none"> Supports 32 Inputs/ 16 Outputs Part No. NC-EIO-R3216 Size: 286x121.7x 54.73 mm (Length x Width x Total Height) 	 <ul style="list-style-type: none"> Part No. NC-HOP-07E-05E (5M cable, Eng. Language) NC-HOP-07E-10E (10M cable, Eng. Language) Size: 257.4x170.3x71.8 mm (Length x Width x Total Height)

Cables and Terminal Blocks			Other
6 axis Pulse-type Servo Motor Control Card	AD Terminal Block	DA Terminal Block	Manual Pulse Generator (MPG)
 <ul style="list-style-type: none"> Provides 6 Sets of Pulse Signal Output Part No.: NC-EIO-PMC06 Size: 217 x 121.78 x 41.9 mm (Length x Width x Total Height) 	 <ul style="list-style-type: none"> Provides Analog Input Type (4 channel ADC) Part No.: NC-EIO-ADC04 Size: 146.25 x 86.78 x 51.05 mm (Length x Width x Total Height) 	 <ul style="list-style-type: none"> Provides Analog Input Type (4 channel DAC) Part No.: NC-EIO-DAC04 Size: 146.25 x 86.78 x 51.05 mm (Length x Width x Total Height) 	 <ul style="list-style-type: none"> Provides Manual Pulse Generator (MPG) Part No.: NC-MPG-105HS-FL Size: 184 x 73 x 71 mm (Length x Width x Total Height)

Panel Cutout (Unit: mm)

NC30E

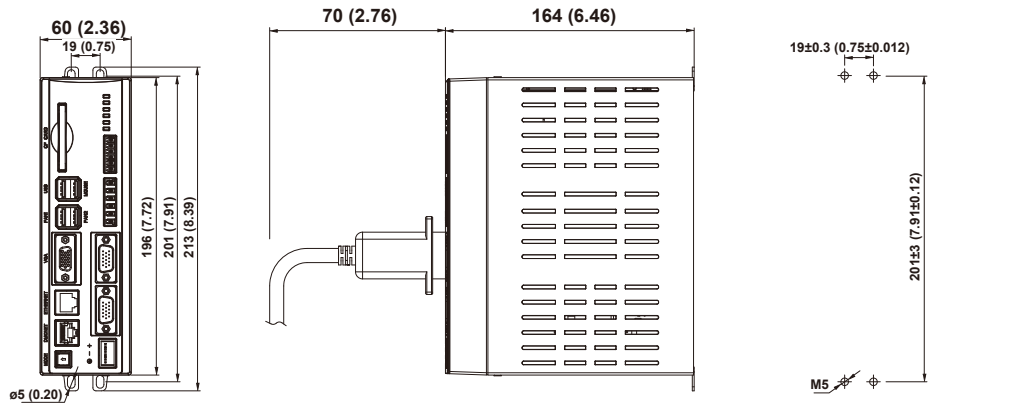

NC30B

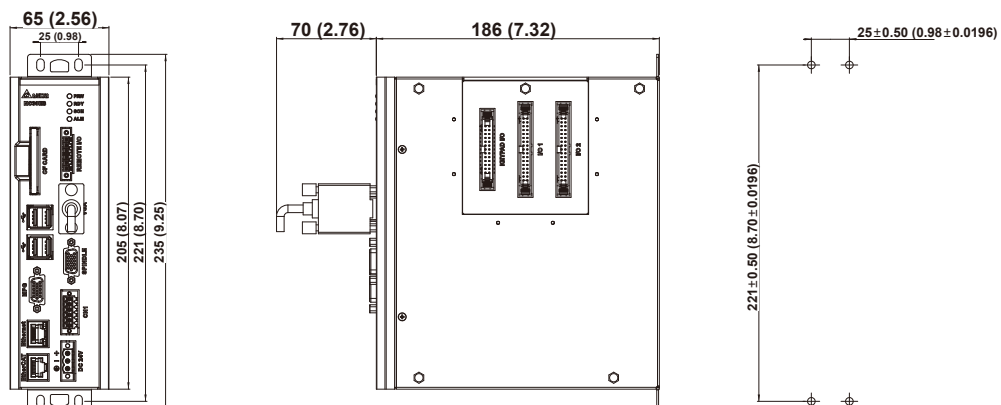



Smarter. Greener. Together.

Industrial Automation Headquarters

Delta Electronics, Inc.

Taoyuan Technology Center
No.18, Xinglong Rd., Taoyuan District,
Taoyuan City 33068, Taiwan
TEL: 886-3-362-6301 / FAX: 886-3-371-6301

Asia

Delta Electronics (Shanghai) Co., Ltd.

No.182 Minyu Rd., Pudong Shanghai, P.R.C.
Post code : 201209
TEL: 86-21-6872-3988 / FAX: 86-21-6872-3996
Customer Service: 400-820-9595

Delta Electronics (Japan), Inc.

Tokyo Office
Industrial Automation Sales Department
2-1-14 Shibadaimon, Minato-ku
Tokyo, Japan 105-0012
TEL: 81-3-5733-1155 / FAX: 81-3-5733-1255

Delta Electronics (Korea), Inc.

Seoul Office
1511, 219, Gasan Digital 1-Ro., Geumcheon-gu,
Seoul, 08501 South Korea
TEL: 82-2-515-5305 / FAX: 82-2-515-5302

Delta Energy Systems (Singapore) Pte Ltd.

4 Kaki Bukit Avenue 1, #05-04, Singapore 417939
TEL: 65-6747-5155 / FAX: 65-6744-9228

Delta Electronics (India) Pvt. Ltd.

Plot No.43, Sector 35, HSIIDC Gurgaon,
PIN 122001, Haryana, India
TEL: 91-124-4874900 / FAX : 91-124-4874945

Delta Electronics (Thailand) PCL.

909 Soi 9, Moo 4, Bangpoo Industrial Estate (E.P.Z),
Pattana 1 Rd., T.Phraksa, A.Muang,
Samutprakarn 10280, Thailand
TEL: 66-2709-2800 / FAX : 662-709-2827

Delta Energy Systems (Australia) Pty Ltd.

Unit 20-21/45 Normanby Rd., Notting Hill Vic 3168, Australia
TEL: 61-3-9543-3720

Americas

Delta Electronics (Americas) Ltd.

Raleigh Office
P.O. Box 12173, 5101 Davis Drive,
Research Triangle Park, NC 27709, U.S.A.
TEL: 1-919-767-3813 / FAX: 1-919-767-3969

Delta Greentech (Brasil) S/A

São Paulo Office
Rua Itapeva, 26 – 3º Andar - Bela Vista
CEP: 01332-000 – São Paulo – SP - Brasil
TEL: 55-11-3530-8642 / 55-11-3530-8640

Delta Electronics International Mexico S.A. de C.V.

Mexico Office
Vía Dr. Gustavo Baz No. 2160, Colonia La Loma,
54060 Tlalnepanitla Estado de Mexico
TEL: 52-55-2628-3015 #3050/3052

EMEA

Headquarters: Delta Electronics (Netherlands) B.V.

Sales: Sales.IA.EMEA@deltaww.com
Marketing: Marketing.IA.EMEA@deltaww.com
Technical Support: iatechnicalsupport@deltaww.com
Customer Support: Customer-Support@deltaww.com
Service: Service.IA.emea@deltaww.com
TEL: +31(0)40 800 3800

BENELUX: Delta Electronics (Netherlands) B.V.

De Witbogt 20, 5652 AG Eindhoven, The Netherlands
Mail: Sales.IA.Benelux@deltaww.com
TEL: +31(0)40 800 3800

DACH: Delta Electronics (Netherlands) B.V.

Coesterweg 45, D-59494 Soest, Germany
Mail: Sales.IA.DACH@deltaww.com
TEL: +49(0)2921 987 0

France: Delta Electronics (France) S.A.

ZI du bois Challand 2, 15 rue des Pyrénées,
Lisses, 91090 Evry Cedex, France
Mail: Sales.IA.FR@deltaww.com
TEL: +33(0)1 69 77 82 60

Iberia: Delta Electronics Solutions (Spain) S.L.U

Ctra. De Villaverde a Vallecas, 265 1º Dcha Ed.
Hormigueras – P.I. de Vallecas 28031 Madrid
TEL: +34(0)91 223 74 20

Carrer Llacuna 166, 08018 Barcelona, Spain

Mail: Sales.IA.Iberia@deltaww.com

Italy: Delta Electronics (Italy) S.r.l.

Ufficio di Milano Via Senigallia 18/2 20161 Milano (MI)
Piazza Grazioli 18 00186 Roma Italy
Mail: Sales.IA.Italy@deltaww.com
TEL: +39 02 64672538

Russia: Delta Energy System LLC

Vereyskaya Plaza II, office 112 Vereyskaya str.
17 121357 Moscow Russia
Mail: Sales.IA.RU@deltaww.com
TEL: +7 495 644 3240

Turkey: Delta Greentech Elektronik San. Ltd. Sti. (Turkey)

Şerifaii Mah. Hendem Cad. Kule Sok. No:16-A
34775 Ümraniye – İstanbul
Mail: Sales.IA.Turkey@deltaww.com
TEL: + 90 216 499 9910

GCC: Delta Energy Systems AG (Dubai BR)

P.O. Box 185668, Gate 7, 3rd Floor, Hamarain Centre
Dubai, United Arab Emirates
Mail: Sales.IA.MEA@deltaww.com
TEL: +971(0)4 2690148

Egypt + North Africa: Delta Electronics

511 Cairo Business Plaza, North 90 street,
New Cairo, Cairo, Egypt
Mail: Sales.IA.MEA@deltaww.com

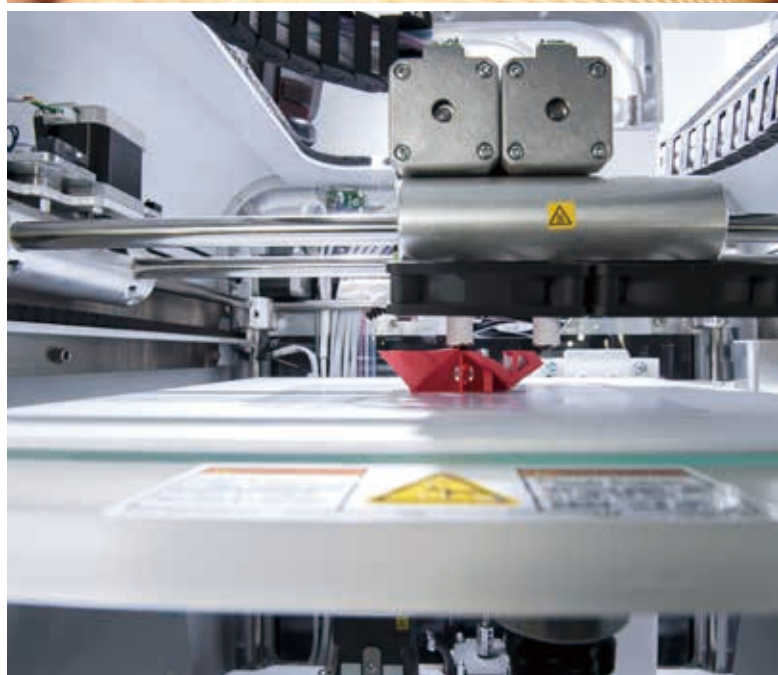
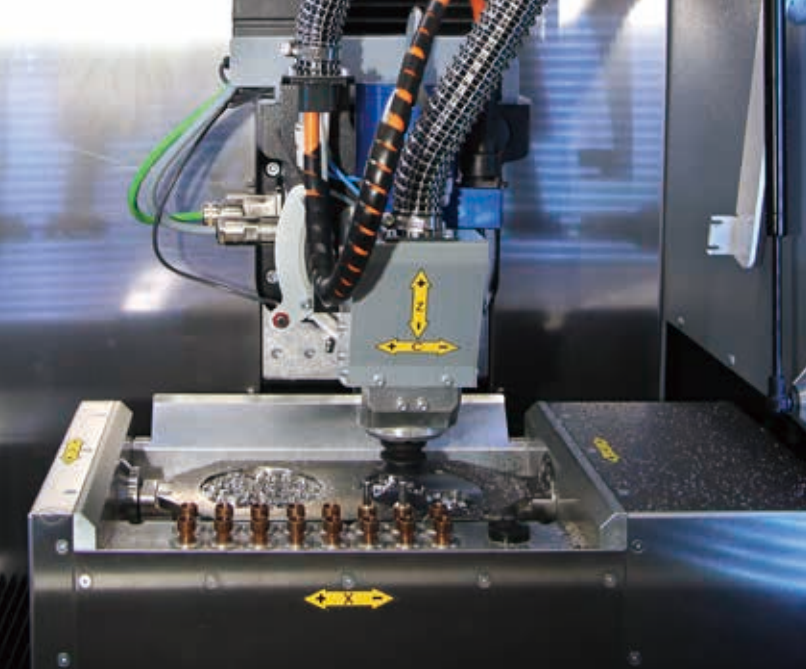

Automation for a Changing World

Delta OPEN CNC Controller NC E Series



www.deltaww.com

 **DELTA**
Smarter. Greener. Together.