



Automation for a Changing World

DELTA Panel PC PPC15X100 User Manual

- DIAVH-PPC153100
- DIAVH-PPC155100
- DIAVH-PPC153101
- DIAVH-PPC155101
- DIAVH-PPC153102
- DIAVH-PPC155102
- DIAVH-PPC153103
- DIAVH-PPC155103
- DIAVH-PPC153104
- DIAVH-PPC155104
- DIAVH-PPC153105
- DIAVH-PPC155105



www.deltaww.com

 **DELTA**
Smarter. Greener. Together.

Disclaimer

This manual is authorized and belongs to Delta Group, without permission, any unauthorized copying is forbidden. The content of this manual can't represent the commitment of Delta Group, as the company continues to improve the products; the company has the right to modify this manual without further notice.

We have no responsibility for any direct/indirect/intentional or unintentional damages and potential problems caused by unsuitable installation and usage.

◆ **Guarantee Clause:**

The product has 18 months' warranty. If the user has special requirement, please do it as the contract signed by the two parties.

◆ **Trademarks:**

All the trademarks mentioned in this manual are registered trademarks of their respective companies.

AMI[®] is the registered trademark of AMI Company.

Intel[®], Celeron[®], Pentium[®] are the registered trademarks of Intel.

NetWare[®] is the registered trademark of Novell Inc.

PS/2 and OS/2 are the registered trademarks of International Business Machines

Windows 7, windows XP, Windows 8 are the registered trademarks of Microsoft

Safety Instructions

1. Please read the user manual carefully before using the product, and carefully keep it for future reference.
2. Before connecting power supply to the product, please confirm the voltage is compliant with the requirement of the device.
3. To avoid electric shock or damage to the product, please unplug the power cord from the socket before cleaning the device by wet rag.
4. Please do not use liquid or aerosol cleaner to clean up the device.
5. To avoid short circuit or fire, please do not let any liquid get into or splash into the product.
6. For a device which needs to use power cord, there must be an easy-to-reach power socket around the device.
7. Please do not use the product in a damp environment.
8. Before installation, please make sure the device is placed on a solid surface; accidental drop or tipping may cause malfunction or damage to the device.
9. Before you connect or unplug any signal cable, make sure all power cords are unplugged in advance.
10. To avoid unnecessary damage caused by frequent power-on/off, wait at least 30 seconds after turning off the computer before re-turning on the computer.
11. If the product will not be used for a long time, please disconnect the power cord, to avoid damage to the product by transient voltage.
12. If the product needs to be upgraded, installed or dismantled, please implement all the operation on an ESD workstation, for some precision devices are sensitive to ESD;
13. Ensure excellent heat dissipation and ventilation of the system.
14. Please do not open or dismantle the device by yourself. For the sake of safety, this device can only be opened by a professional maintenance person.

◆ Packing List

A fanless industrial Computer

1*AC 110V~240V to DC+12V/5A power adapter

1*AC220V power cable

2*Mounting Bracket & 6*Screw

1*Driver CD & manual

1*Certification

Contents

Disclaimer	1
Safety Instructions	2
Brief Introduction	5
1.1 Introduction	5
1.2 Product Specifications	6
1.3 I/O Interface	7
Application Planning	8
2.1 Transportation	8
2.2 Storage Requirements	8
2.3 Unpack and check the delivered equipment	8
Installation Instructions.....	9
3.1 Product Photo	9
3.2 Product Dismounting	9
3.3 Product Outline	10
Interface Definition	11
4.1 USB Interface.....	11
4.2 Network Interface	11
4.3 Standard DB9 Comports	12
4.4 Standard VGA Interface	12
4.5 Standard HDMI A Type Interface.....	13
4.6 Power Interface	13
Appendix.....	14
5.1 BIOS Setting	14
5.2 Driver Installation.....	19
5.3 Trouble Shooting	20

Brief Introduction

1.1 Introduction

DIAVH-PPC15X100 is a low-power-consumption, high-performance and Fanless embedded industrial computer, and its material is high-strength and elegant al-alloy and the radiator high-density al-alloy.

This product is with on-board low power consumption Intel Core I3-3227U (spare part 3217U) / I5-3337U (spare part 3317U) , Max to 8GB DDRIII RAM, and it has rich I/O interfaces and it is with fully-sealed Fanless design, supporting windows XP/Windows 7/ Linux and so on.

This product can be used in the field of mechanical equipment, intelligent transportation, industrial automation control and other different embedded solutions.

1.2 Product Specifications

Item	Detail	
Main Function	Processor	<ul style="list-style-type: none"> ● DIAVH-PPC153100: Intel® Core I3-3227U(Main) I3-3217U(Alternative) ● DIAVH-PPC155100: Intel® Core I5-3337U(Main) I5-3317U(Alternative)
	RAM	DDRIII 4GB DDRIII 1333MHz
	Display	Intel® HD 4000350-1100MHz
	Storage	Standard 512G SSD (System Disk)
	Ethernet	2*RTL8111E
	Audio	1*Line out
	Expansion	Support Mini-PCIE
	LED	<ul style="list-style-type: none"> ● Display: 15"TFT LED ● Resolution: 1024x768 ; ● Brightness: 350cd/m2 ● Contrast: 400: 1 ● Adjustable viewing angle CR≥10) ● Horizontal: 60°~60° ; Vertical: -60°~65°
	Touch screen	<ul style="list-style-type: none"> ● Wire resistance
IO Port	<ul style="list-style-type: none"> ● 3*COM (2*RS232 , 1*RS485/RS422) ● 4*USB2.0 ● 2*1000M LAN ● 1*VGA ● 1* HDMI ● 1*Line out 	
Performance	Dimensions	<ul style="list-style-type: none"> ● DIAVH-PPC15X100 380mm×300mm×60mm
	Structure	<ul style="list-style-type: none"> ● Panel: Aluminium alloy ● Colour: Silver
	Weight	<ul style="list-style-type: none"> ● DIAVH-PPC15X100: 5.6Kg / 7.6Kg
	TEMP	<ul style="list-style-type: none"> ● Operating temperature:-10°C ~ 60°C ● Storage temperature: -20°C ~ 70°C
	Humidity	90% @ 40°C (NON-condensing)
	EMC	<ul style="list-style-type: none"> ● GB9254-1998 Class A ● GB/T 17618-1998
	Reliability	<ul style="list-style-type: none"> ● MTBF ≥ 50000h ● MTTR ≤ 0.5h
	Safety	CE / FCC/ Rohs
	Mechanical Properties	<ul style="list-style-type: none"> ● Anti-vibration: 5-19Hz/1.0mm amplitude; 19-200Hz/1.0g, acceleration ● Anti-shock: 10g acceleration, 11ms duration
	Power	<ul style="list-style-type: none"> ● 100~220VAC/50~60Hz (Adapter); 12VDC9~36VDC (NONadapter) Optional; ● Power Dissipation: 17 W(tandby); ● Power: 30 W (MaxPower 100%);

1.3 I/O

DIAPH-PPC153100/01/02/03/04/05 (DIAPH-PPC155100/01/02/03/04/05)

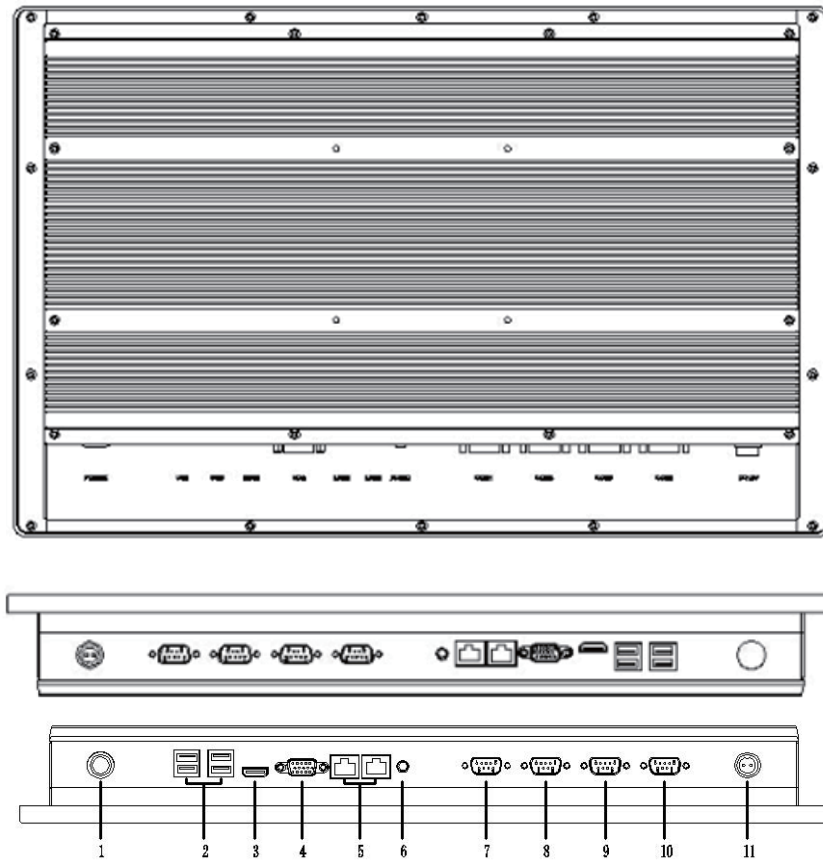

Picture 1-1

1. Power	2. USB	3. HDMI	4. VGA	5. LAN
6. Line out	7. COM 1	8. COM 2	9. COM 3	10. COM 4
11. DC In				

Application Planning

2.1 Transportation

Well-packaged products are suited for transportation by truck, ship, and plane. During transportation, products should not be put in open cabin or carriage. During transshipping, products should not be stored in open air without protection from the atmospheric conditions. Products should not be transported together with inflammable, explosive and corrosive substances and are not allowed to be exposed to rain, snow and liquid substances and mechanical force.

2.2 Storage Requirements

Products should be stored in package box when it is not used. And warehouse temperature should be $-20^{\circ}\text{C}\sim 70^{\circ}\text{C}$, and relative humidity should be 20% ~ 85%. In the warehouse, there should be no harmful gas, inflammable, explosive products, and corrosive chemical products, and strong mechanical vibration, shock and strong magnetic field interference. The package box should be at least 10cm above ground, and 50cm away from wall, thermal source, window and air inlet

Caution!



Risk of destroying the device!

When shipping the PC in cold weather, please pay attention to the extreme temperature variation. Under this circumstance, please make sure no water drop (condensation) is formed on the surface or interior of the device. If condensation is formed on the device, please wait for over twelve hours before connecting the device.

2.3 Unpack and check the delivered equipment

Unpack the equipment

Pay attention to the following things when you unpack the equipment.

- Please take the advice not to throw away the original packaging material and please retain to use it when the equipment should be transported again.
- Please put the document in a safe place. It will be used in the initial adjustment of equipment and it is a part of the equipment.
- When you check the delivered equipment, please check whether it is obviously damaged during the transportation.
- Please check whether the delivered parcel includes the whole equipment and the accessories you ordered separately. If there is any discrepancy or damaged during transportation, please contact our customer-service staff.

Installation Instructions

3.1 Product Photo

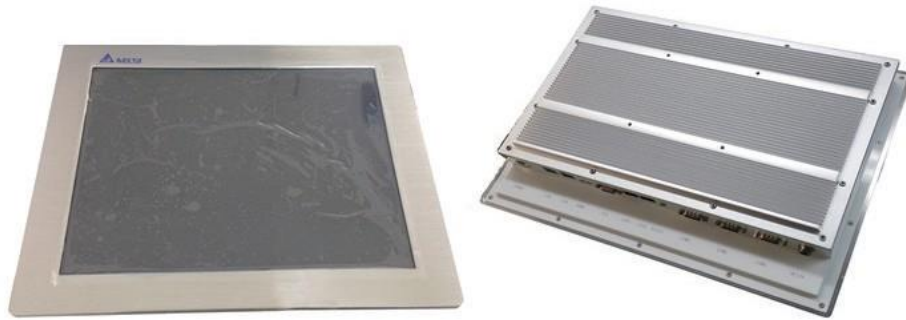

Picture 3-1

3.2 Product Dismounting

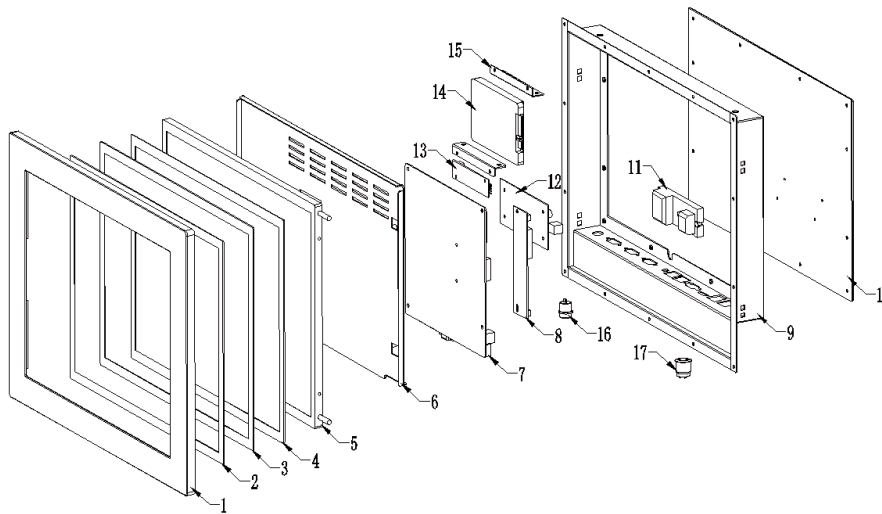

Picture 3-2

1	Aluminum alloy metal shell	7	Mother	13	Touchscreen Board
2	3M Seal Gel	8	Booster Plate	14	HDD
3	Touch Glass	9	Back Cover	15	HDD kit
4	Sponge	10	Heat Sink	16	DC Input connector
5	LCD	11	Thermal Block	17	Power On/Off & Power
6	LCD Kit	12	Wide Voltage Module		

3.3 Product Outline

DIAVH-PPC153100 (DIAVH-PPC155100)

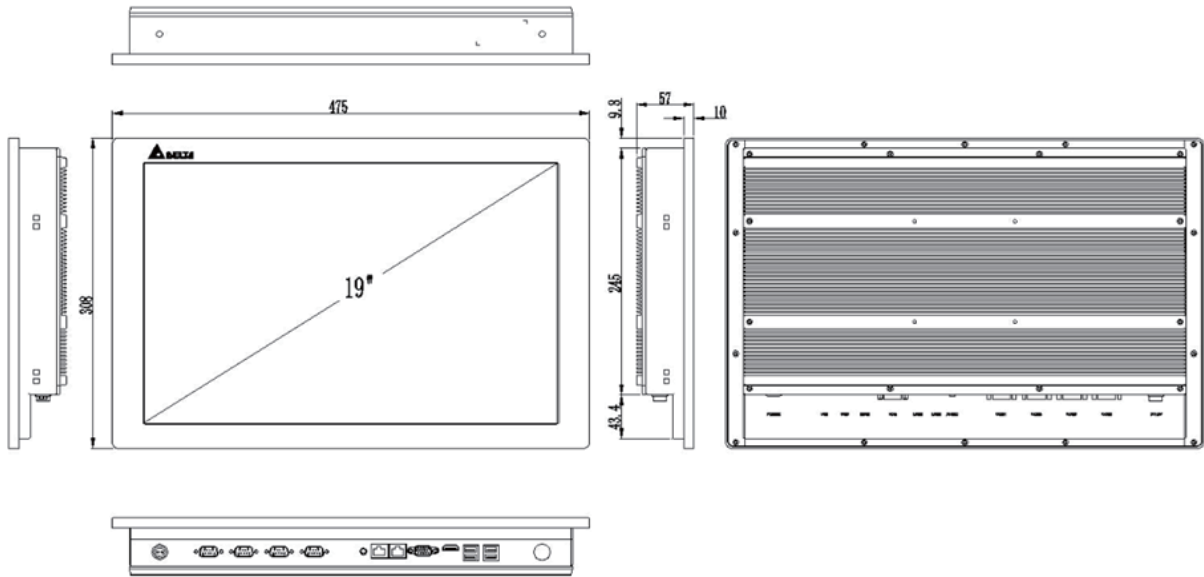

Picture 3-3

Product Interface

4.1 USB Interface

4* USB2.0 Interface. Definition:

 <p>USB1~4</p>	USB	Singal
	1	+5V
	2	USB Data-
	3	USB Data+
4	GND	

4.2 Network Interface

2* RJ45 LAN Interface. Definition:

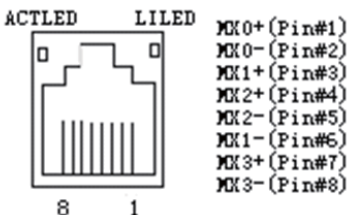
 <p>LAN1,LAN2</p>			
ACTLED	Network Status	LILED (Green/Orange)	Network Speed
(Green light)		Green	1000Mbps
Twinkle	Data Transmission	Orange	100Mbps
Light off	No Data Transmission	Light off	10Mbps

4.3 Standard DB9 Comports

4*Comports Interface. Definition:

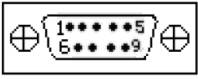
 <p>COM1~4</p>	PIN	Signal	
		RS-232	RS-485
	1	DCD#	DATA-
	2	RXD	DATA+
	3	TXD	X
	4	DTR#	X
	5	GND	GND
	6	DSR#	X
	7	RTS#	X
	8	CTS#	X
9	RI#	X	

4.4 VGA Interface

15 PIN D Type VGA Interface. Definition:

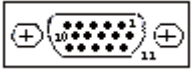
 <p>VGA</p>	PIN	Signal	PIN	Signal
	1	Red	2	Green
	3	Blue	4	N.C.
	5	GND	6	Detect
	7	GND	8	GND
	9	+5V	10	GND
	11	NC	12	DDCDATA
	13	HSYNC	14	VSYNC

4.5 HDMI A Type Interface

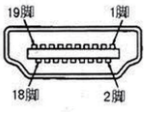
 <p>HDMI</p>	PIN	Signal	PIN	Signal
	1	DATA2+	2	DATA2 shielding
	3	DATA2-	4	DATA1+
	5	DATA1 shielding	6	DATA1-
	7	DATA0+	8	DATA0 shielding
	9	DATA0-	10	DATA1_CK+
	11	DATA1_CK shielding	12	DATA1_CK-
	13	CEC	14	Reserved
	15	SCL (DDC CLOCK)	16	SDA (DDC CLOCK)
	17	DCC/CEC GND	18	+5V
19	RIUP check			

4.6 Power Interface

DC+12V Power Input. Definition:

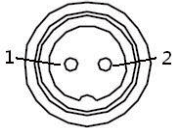
 <p>DC12V Input</p>	PIN	Signal
	1	+12V
2	GND	

Appendix

5.1 BIOS Setting

5.1.1 Main Page

Press “Del” after startup and enter BIOS CMOS program. The first page as below and user can set date and time.

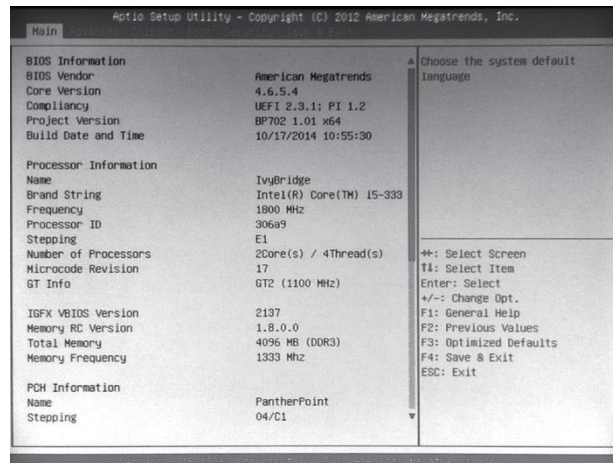

Picture
5-1

5.1.2 Advanced Functions

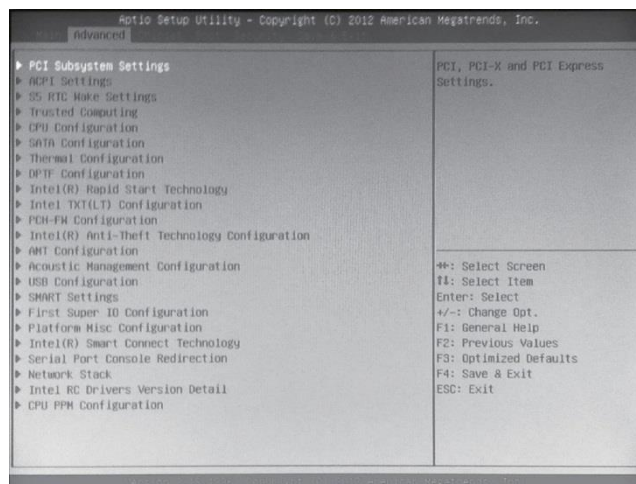

Picture
5-2

- ◆ PCI Subsystem Settings ;
- ◆ ACPI Settings ;
- ◆ S5 RTC Wake Settings
- ◆ CPU Configuration;
- ◆ SATA Configuration ;
- ◆ Thermal Configuration ;
- ◆ USB Configuration ;

- ◆ First Super IO Configuration ;
- ◆ Serial Port Console Redirection ;
- ◆ Network Stack ;
- ◆ Intel RC Drivers Version Detail ;
- ◆ CPU PPM Configuration ◦

5.1.3 Chipset Function

Enter 5-3.1 Picture and choose “System Agent” to Picture 5-3.2. Choose Graphics Configuration and enter Picture 5-3.3. Choose LCD Control and enter Picture 5-4.1

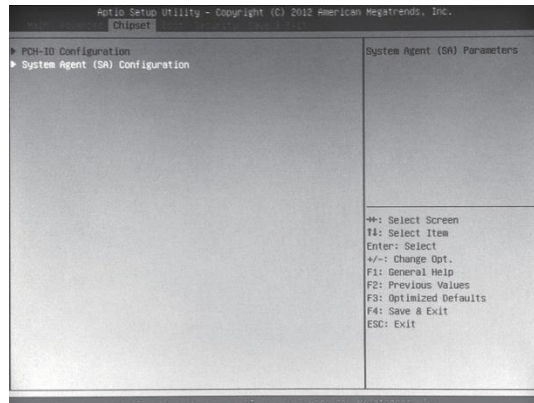

Picture 5-3.1

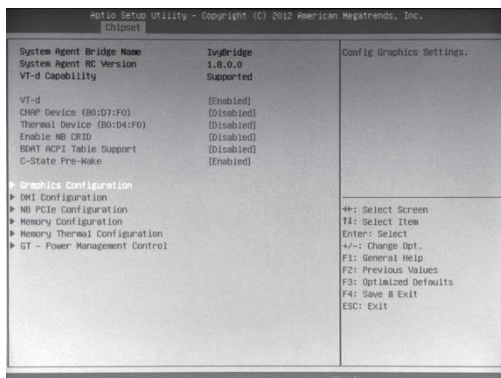

Picture 5 -3.2

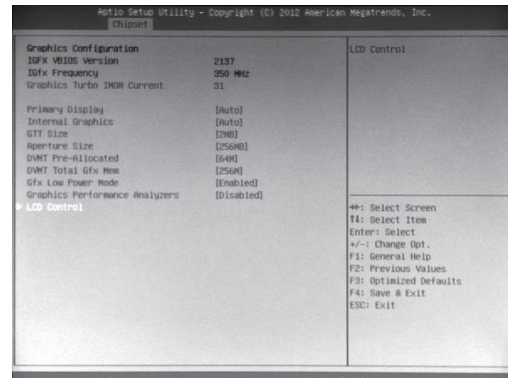

Picture 5 -3.3

In CD Panel Type item, users can modify PPC default resolution. If the setting resolution cannot match to actual solution in PPC, the display will be abnormal as Picture 5-4.2

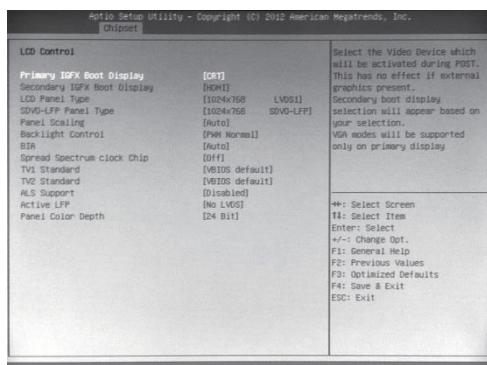

Picture 5-4.1

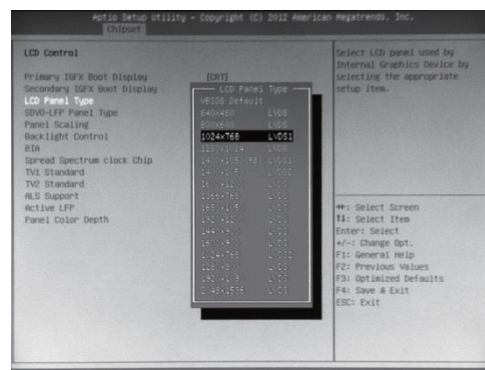

Picture 5-4.2

Restore AC Power Loss can choose **【Power off】** via pushing power button or plug/remove power directly. **【Last Status】** can set recovery last use status as abnormal shut down like Picture 5-5 showed.

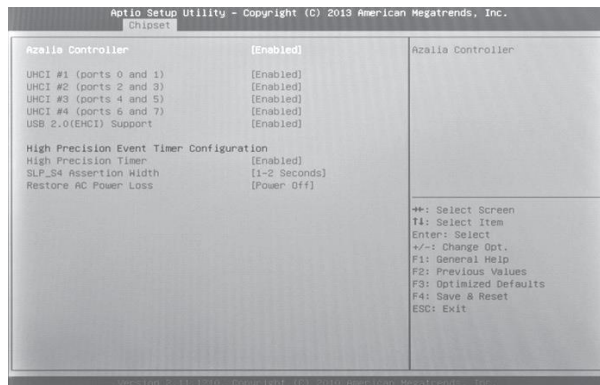

Picture 5-5

5.1.4 Boot Function

This function can setup Num Lock keyboard status as power-on and can set the storage sequence. Go to Hard Drive BBS Priorities function, choose the storage device in Boot Option #1, and press F4 to save.

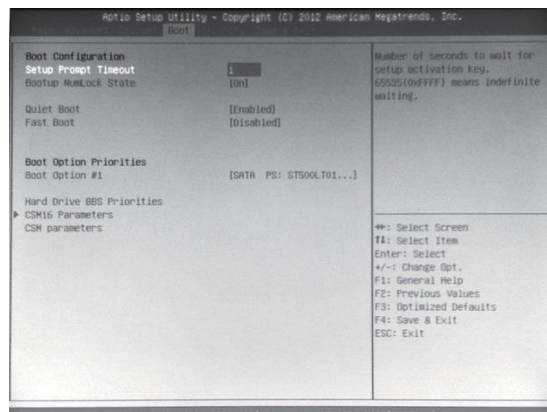

Picture 5-6

Enter Hard Drive BBS Priorities Function list. Choose first storage device in Boot Option #1 as Picture 5-7:

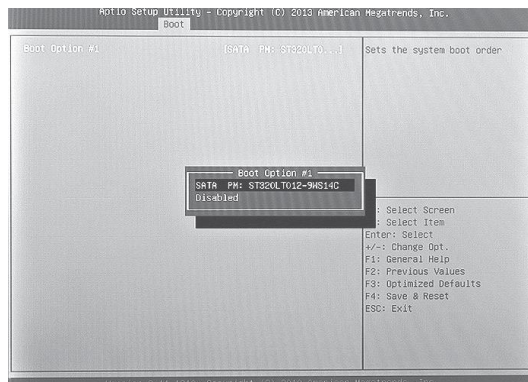

Picture 5-7

Finish Setting the storage device, press ESC back to last page and choose the device in Boot Option #1 again as Picture 5-8. Press F4 to save and press Enter to exit the page.

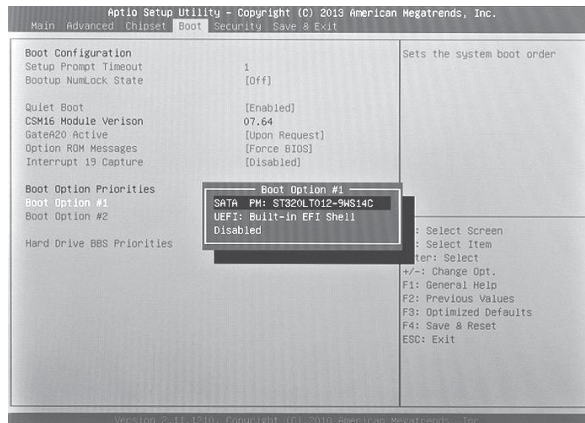

Picture 5-8

5.1.5 Security Function

This function can set BIOS setup Password and PPC Power-on Password as Picture 5-9.

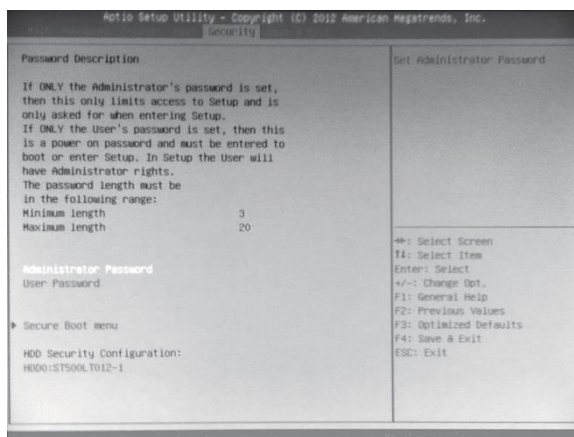

Picture 5-9

5.1.6 Save & Exit Function

Enter CMOS pages and choose “Save & Exit” to set up as Picture 5-10 show. Press F3 “Restore Default”. Press F4 to “Save” setup.

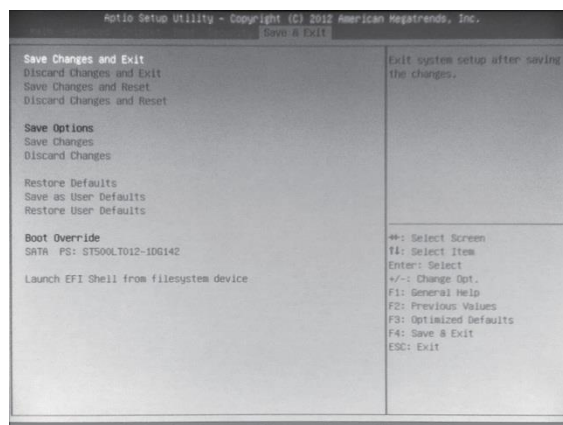

Picture 5-10

5.2 Driver Installation

5.2.1 Chipset Driver Installation

- (1) Enter DVD content Driver\Chipset\ contents and click “Intel_inf.exe”.
- (2) Click “Next” and “Continue”.
- (3) Click “Finish” and restart the computer to finish the installation.

5.2.2 Onboard Display Card Installation

- (1) Enter DVD content Driver\ Graphic\ contents, choose the PPC OS folder and click “setup.exe”.
- (2) Click “Next” and “Continue”.
- (3) Click “Finish” and restart the computer to finish the installation.

5.2.3 Onboard Sound Card Installation

- (1) Enter DVD content Driver\ Audio\ contents, choose the PPC OS folder and click “setup.exe”.
- (2) Click “Next” and “Continue”.
- (3) Click “Finish” and restart the computer to finish the installation.

5.2.4 Onboard Network Card Installation

- (1) Enter DVD content Driver\ LAN\ contents, choose the PPC OS folder and click “setup.exe”.
- (2) Click “Next” and “Continue”.
- (3) Click “Finish” and restart the computer to finish the installation.

5.2.5 Touchscreen driver Installation

- (1) Enter DVD content Driver\Touchscreen\ contents, choose eGalaxTouch or Touchkit folder and click “setup.exe”.
- (2) Click “Next” and “Continue”.
- (3) Click “Finish” and restart the computer to finish the installation.

5.3 Touch Correction

5.3.1 Touch Monitor Correction

Enter Touch Control software – “eGalaxTouch USB Controller” which default install in the desktop. Click “General” and “Monitor mapping” to do the correction.

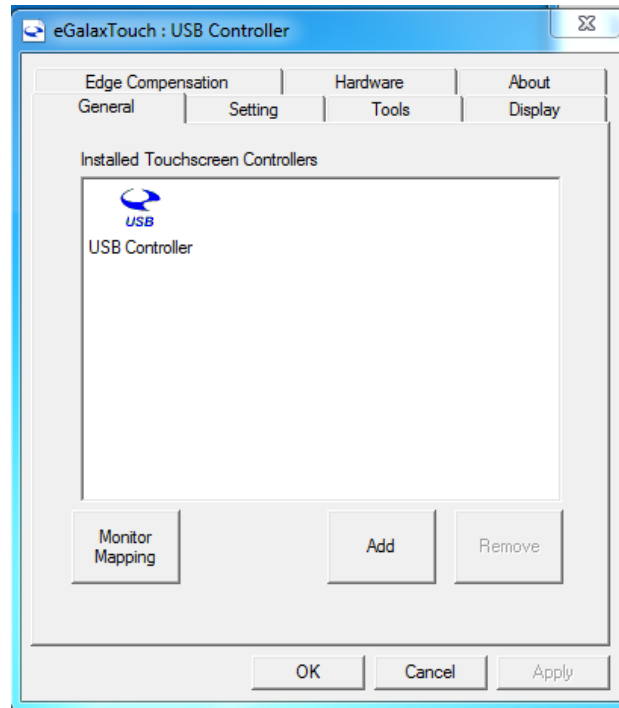

Picture 5-11

5.3.2 Setting

Set the Beep on Touch in “Setting”. User can set open the Beep as touch or close the function. Define the points in Linearization Style. (Picture 5-12)

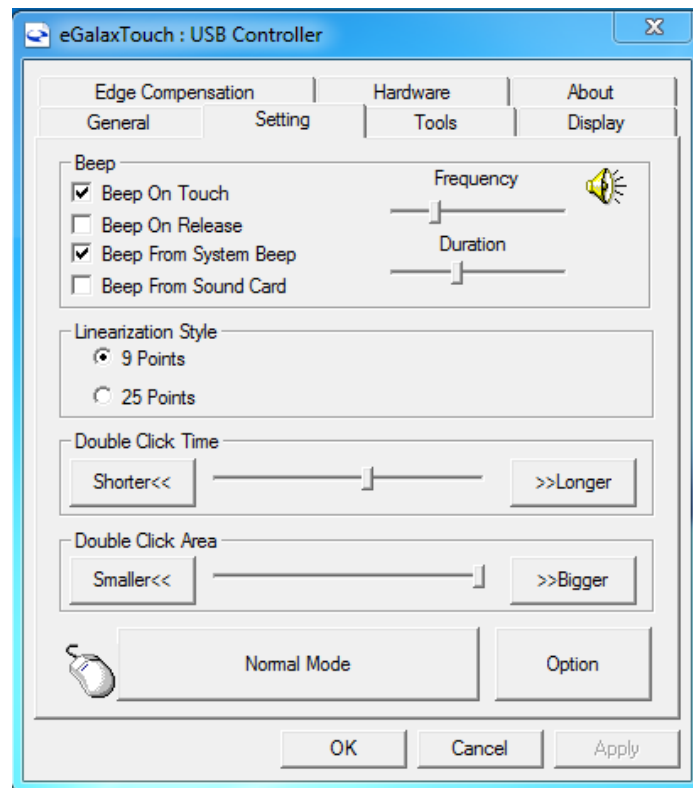

Picture 5-12

- Click once: Click the monitor once.
- Click Twice: Click the monitor twice.
- Right click: Touch the monitor 1 second.

5.3.3 Tool

First, choose 4 points Calibration to match display and clear the linearization parameter and do 4 points alignment. Check 9 points linearization for better touch linearity. (Picture 5-13)

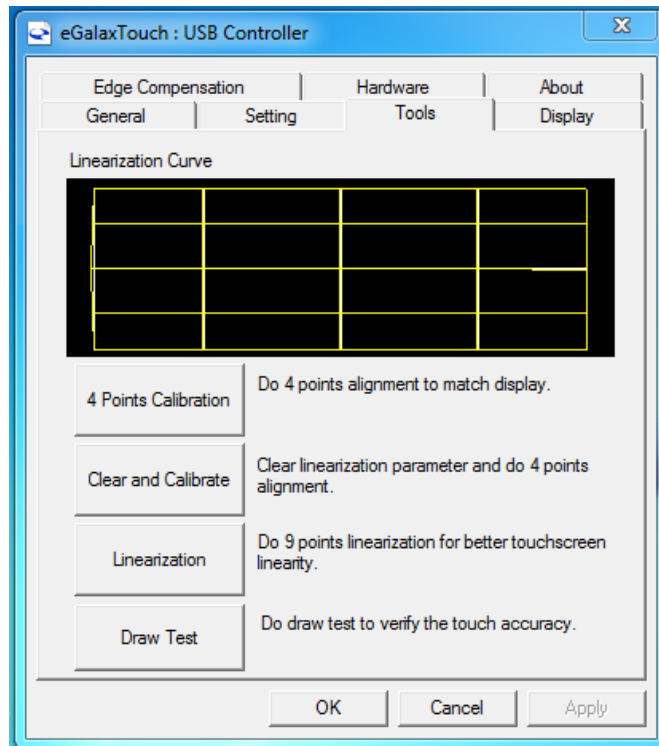

Picture 5-13

5.3.4 Display Monitor (Picture 5-14) and Edge Compensation (Picture 5-15)

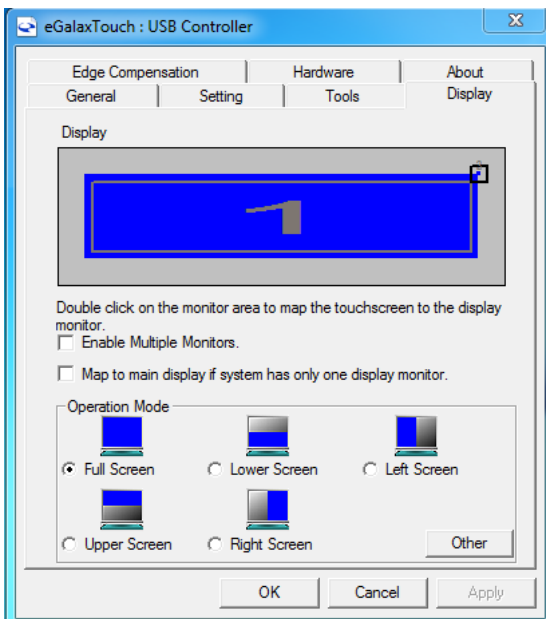

Picture 5-14

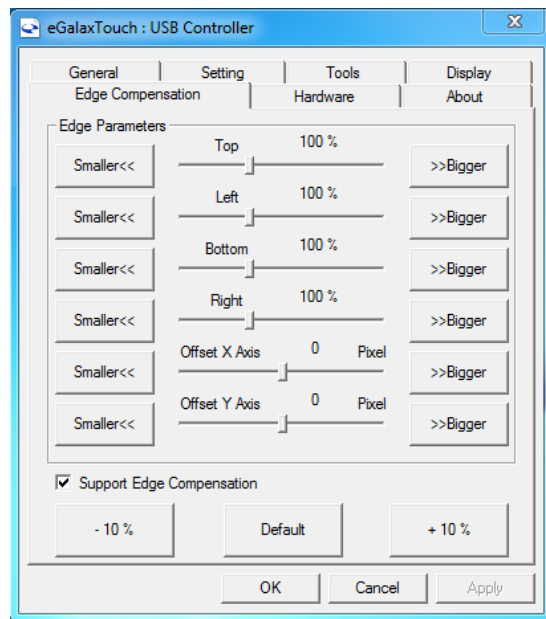

Picture 5-15

5.4 Trouble Shooting

Common Malfunction	Possible Reasons	Trouble shooting and solution
The device is not operating	No power supply	Please check the power supply and the power cable/connector
	Improper device operating environment	<ol style="list-style-type: none"> 1. Check the environment conditions 2. Please wait for 12 hours before powering on the device shipped in cold day.
The external display is black	The display has not been turned on	Turn on the display
	Display output jump to another display output channel	Enter OS and use Ctrl+Alt+F1/F2/F3/F4 to change the display output within VGA/DVI/LVDS/HDMI.
	The display is under "power saving" mode	Press any key on the keyboard.
	The luminance control is set to "Black"	Increase the screen luminance by luminance control. Please refer to the instructions of the display for detailed information.
	Power cable or display cable is not connected	<ol style="list-style-type: none"> 1. Please check whether the power cable & display cable is correctly connected with the display, the system unit or the ground port 2. Contact technique support if the screen remains black after implementing the above measures. 3. If the display still black, please contact the service support.
Incorrect time or date on PC	Incorrect BIOS setting	Follow the power-on prompt and press the key to enter the BIOS setup, adjust the time and date in BIOS setup.
BIOS setting is correct while the time and date are not correct	Insufficient backup battery capacity	Replace the battery
USB device has no response	USB port is disabled in BIOS	Use other USB ports or enable that port.
	USB2.0 device is connected while USB 2.0 is disabled	Enable USB 2.0.
	USB port is not supported by the operating system	Enable USB Legacy Support for the mouse & keyboard (legacy USB is supported) ; For other device, appropriate USB drivers are required.
Boot device not found	In booting priority of the BIOS setting, the device is not the first priority or the device is not include in the booting device	Modify the booting priority of the device in the Boot menu of BIOS setting or include that device into the booting priority
No system disk can be found when powering on	The HDD power cable or data cable is not connected well	Check whether the power cable and the data cable of the hard disk (the hard disk shall be installed with operating system and is bootable) are well connected
	System files on the hard disk are damaged	Enter the system (usually WinPE system) with a bootable disk check whether the system in the hard disk is damaged. Reinstall the system if necessary.
Plug and play I/O card, no I/O card is detected, or I/O card can be used when used again	Poor contact of the slot	Poor contact is usually caused by frequent installation/uninstallation of the PCI or ISA card, unstable fixing or improper dust-proof measures; please remove and install the card for a few times or use another slot.



Industrial Automation Headquarters

Delta Electronics, Inc.

Taoyuan Technology Center
No.18, Xinglong Rd., Taoyuan Dist.,
Taoyuan City 33068, Taiwan
TEL: 886-3-362-6301 / FAX: 886-3-371-6301

Asia

Delta Electronics (Jiangsu) Ltd.

Wujiang Plant 3
1688 Jiangxing East Road,
Wujiang Economic Development Zone
Wujiang City, Jiang Su Province,
People's Republic of China (Post code: 215200)
TEL: 86-512-6340-3008 / FAX: 86-769-6340-7290

Delta Greentech (China) Co., Ltd.

238 Min-Xia Road, Pudong District,
ShangHai, P.R.C.
Post code : 201209
TEL: 86-21-58635678 / FAX: 86-21-58630003

Delta Electronics (Japan) , Inc.

Tokyo Office
2-1-14 Minato-ku Shibadaimon,
Tokyo 105-0012, Japan
TEL: 81-3-5733-1111 / FAX: 81-3-5733-1211

Delta Electronics (Korea) , Inc.

1511, Byucksan Digital Valley 6-cha, Gasan-dong,
Geumcheon-gu, Seoul, Korea, 153-704
TEL: 82-2-515-5303 / FAX: 82-2-515-5302

Delta Electronics Int'l (S) Pte Ltd

4 Kaki Bukit Ave 1, #05-05, Singapore 417939
TEL: 65-6747-5155 / FAX: 65-6744-9228

Delta Electronics (India) Pvt. Ltd. Plot

No 43 Sector 35,
HSIIDC Gurgaon, PIN
122001, Haryana, India
TEL : 91-124-4874900 / FAX : 91-124-4874945

Americas

Delta Products Corporation (USA)

Raleigh Office
P.O. Box 12173,5101 Davis Drive,
Research Triangle Park, NC 27709, U.S.A.
TEL: 1-919-767-3800 / FAX: 1-919-767-8080

Delta Greentech (Brasil) S.A

Sao Paulo Office
Rua Itapeva, 26 - 3º andar Edifício Itapeva One-Bela Vista
01332-000-São Paulo-SP-Brazil
TEL: +55 11 3568-3855 / FAX: +55 11 3568-3865

Europe

Delta Electronics (Netherlands) B.V.

Eindhoven Office
De Witbogt 20, 5652 AG Eindhoven, The Netherlands
TEL: +31 (0)40-8003800 / FAX: +31 (0)40-8003898