



# **DVPEN01-SL**

## ***Ethernet Communication Module***

# **Operation Manual**



<http://www.delta.com.tw/industrialautomation>





## **Warning**

- ✓ Please read this instruction carefully before use and follow this instruction to operate the device in order to prevent damages on the device or injuries to staff.
- ✓ Switch off the power before wiring.
- ✓ RTU-DNET is an OPEN TYPE device and therefore should be installed in an enclosure free of airborne dust, humidity, electric shock and vibration. The enclosure should prevent non-maintenance staff from operating the device (e.g. key or specific tools are required for operating the enclosure) in case danger and damage on the device may occur.
- ✓ RTU-DNET is to be used for controlling the operating machine and equipment. In order not to damage it, only qualified professional staff familiar with the structure and operation of RTU-DNET can install, operate, wire and maintain it.
- ✓ DO NOT connect input AC power supply to any of the I/O terminals; otherwise serious damage may occur. Check all the wirings again before switching on the power and DO NOT touch any terminal when the power is switched on. Make sure the ground terminal ⊕ is correctly grounded in order to prevent electromagnetic interference.



## **Table of Contents**

<b>1</b>	<b>INTRODUCTION.....</b>	<b>3</b>
	1.1 Functions.....	3
	1.2 Specifications .....	3
<b>2</b>	<b>PRODUCT PROFILE &amp; OUTLINE.....</b>	<b>4</b>
	2.1 Dimension .....	4
	2.2 Product Profiles .....	4
	2.3 LED Indicators.....	4
	2.4 RJ-45 PIN Definition .....	5
<b>3</b>	<b>INSTALLATION &amp; WIRING.....</b>	<b>5</b>
	3.1 Installation .....	5
	3.2 Connecting DVPEN01-SL to the Network:.....	6
<b>4</b>	<b>CONTROL REGISTER (CR).....</b>	<b>6</b>
	4.1 Control Registers in DVPEN01-SL .....	6
	4.2 Explanations on CR.....	8
	4.3 Numbering of Left-Side Modules .....	14
<b>5</b>	<b>SETTING THE SOFTWARE .....</b>	<b>15</b>
	5.1 Setting Communication & Searching for Modules .....	15
	5.2 Basic Settings.....	21
	5.3 Network Settings .....	22
	5.4 Setting E-mails .....	25
	5.5 SNMP .....	26
	5.6 Data Exchange.....	27
	5.7 MELSEC Protocol.....	28
	5.8 RTU.....	30

5.9	IP Filter .....	31
5.10	Static ARP Table .....	31
5.11	Setting a Password .....	32
5.12	Returning to Default Settings .....	33
<b>6</b>	<b>APPLICATION EXAMPLES .....</b>	<b>34</b>
6.1	Setting an IP Address and Communication through WPLSoft .....	34
6.2	Connecting the PC with DVPEN01-SL through LAN .....	36
6.3	Setting a Password and Clearing a Password .....	38
6.4	When the Password is Lost (Returning to Default Setting by RS-232) .....	41
6.5	IP Filter Protection .....	42
6.6	Setting a Static ARP Table .....	44
6.7	Application of E-mails .....	46
6.8	Application of Data Exchange (1).....	47
6.9	Application of Data Exchange (2).....	49
6.10	Application of Data Exchange (3).....	51
6.11	Application of Data Exchange (4).....	52
6.12	Application of Data Exchange (5).....	54
6.13	Application of MODBUS TCP Master .....	55
6.14	RTU Mapping.....	56
6.15	Application of the MELSEC Protocol.....	58

## 1 Introduction

Thank you for choosing DVPEN01-SL module. To correctly install and operate DVPEN01-SL, please read the manual carefully before using the module.

DVPEN01-SL is an Ethernet communication module for remote setting and communication through WPLSoft. DVPEN01-SL is able to send E-mails, automatically correct the RTC in DVP28SV11R/T and exchange data. It supports MODBUS TCP communication protocol and can conduct remote monitoring by using SCADA (Supervisor Control and Data Acquisition) software or HMI (Human Machine Interfaces). DVPEN01-SL can be the master of MODBUS TCP, sending out MODBUS TCP instructions and controlling the peripheral equipment. In addition, under MDI/MDI-X auto-detection, it does not need to use a crossing cable. See the contents below for more detailed instructions on DVPEN01-SL module.

### 1.1 Functions

- Auto-detects 10/100Mbps transmission speed
- MDI/MDI-X auto-detection
- Supports MODBUS TCP protocol (at the same time supports Master and Slave mode)
- Able to send out E-mails
- Auto-corrects the RTC in PLC through the Internet time correction function
- Supports point-to-point data exchange (Max. data exchange length: 200 bytes)

### 1.2 Specifications

#### ■ Internet interface

Item	Specification
Interface	RJ-45 with Auto MDI/MDIX
Number of ports	1 Port
Transmission method	IEEE802.3, IEEE802.3u
Transmission cable	Category 5e / UC-PRG030-20A (3M)
Transmission speed	10/100 Mbps Auto-Detect
Network protocol	ICMP, IP, TCP, UDP, DHCP, SMTP, NTP, MODBUS TCP, SNMP

#### ■ Serial communication interface

Item	Specification
Interface	RS-232
Number of ports	1 Port
Transmission cable	UC-MS030-01A (3M) / UC-MS010-02A (1M) / UC-PRG020-12A (2M)

#### ■ Environment

Item	Specification
Noise immunity	ESD (IEC 61131-2, IEC 61000-4-2): 8KV Air Discharge EFT (IEC 61131-2, IEC 61000-4-4): Power Line: 2KV Analog & Communication I/O: 1KV Damped-Oscillatory Wave: Power Line: 1KV RS (IEC 61131-2, IEC 61000-4-3): 26MHz~1GHz, 10V/m
Environment	Operation: 0°C~55°C (temperature), 5~95% (humidity), Pollution degree 2; Storage: -25°C~70°C (temperature), 5~95% (humidity)
Vibration/ Resistance	Shock Standard: IEC61131-2, IEC 68-2-6 (TEST Fc)/IEC61131-2 & IEC 68-2-27 (TEST Ea)

## ■ Electrical specifications

Item	Specification
Power supply voltage	24VDC (-15%~20%) (Power is supplied by the internal bus of MPU.)
Power consumption	1.5W
Insulation voltage	500V
Weight (g)	92 (g)

## 2 Product Profile & Outline

### 2.1 Dimension

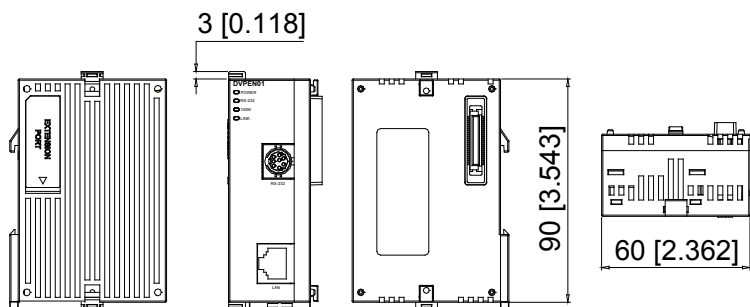

Unit: mm [inches]

### 2.2 Product Profiles

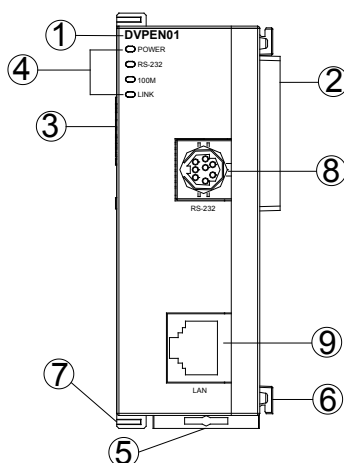

1. Model name	6. Fixing tenon for I/O module
2. Extension port to connect device	7. Fixing clip for I/O module
3. Extension port to connect I/O module	8. RS-232 connection port
4. POWER, LINK, RS-232, 100M indicators	9. Ethernet RJ-485 connection port
5. DIN rail clip	

### 2.3 LED Indicators

Indicator	Color	Indication
POWER	Green	Power indication
RS-232	Red	Communication status of the series port
100M	Orange	Network connection status
LINK	Green	Network communication speed

## 2.4 RJ-45 PIN Definition

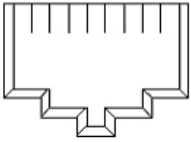
RJ-45 sketch	Terminal No.	Definition	Explanation
	1	Tx+	Positive pole for data transmission
	2	Tx-	Negative pole for data transmission
	3	Rx+	Positive pole for data receiving
	6	Rx-	Negative pole for data receiving
	4, 5, 7, 8	-	N/C

## 3 Installation & Wiring

This section gives instructions on how to connect DVPEN01-SL with PLC MPU and how to connect DVPEN01-SL to the network.

### 3.1 Installation

Connecting PLC MPU to DVPEN01-SL:

- Adjust the I/O module clip on the left side of the MPU.
- Meet the I/O module port of the MPU with DVPEN01-SL as shown in the figure below.
- Fasten the I/O module clip on the left side of the MPU.

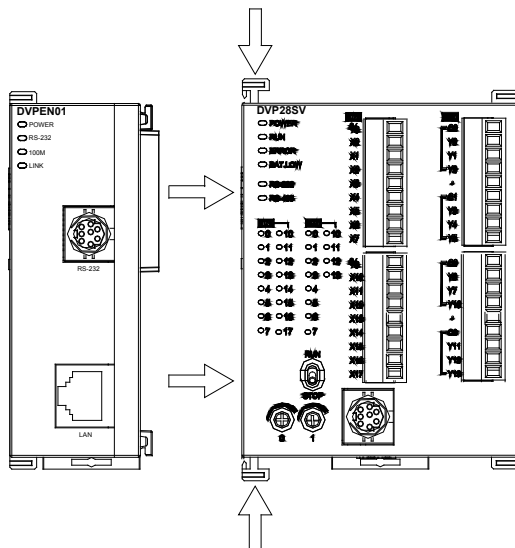

Connecting DVPEN01-SL to other I/O modules:

- To connect DVPEN01-SL with the other I/O module, lift the extension clip of the I/O module by a screwdriver and open the side cover.

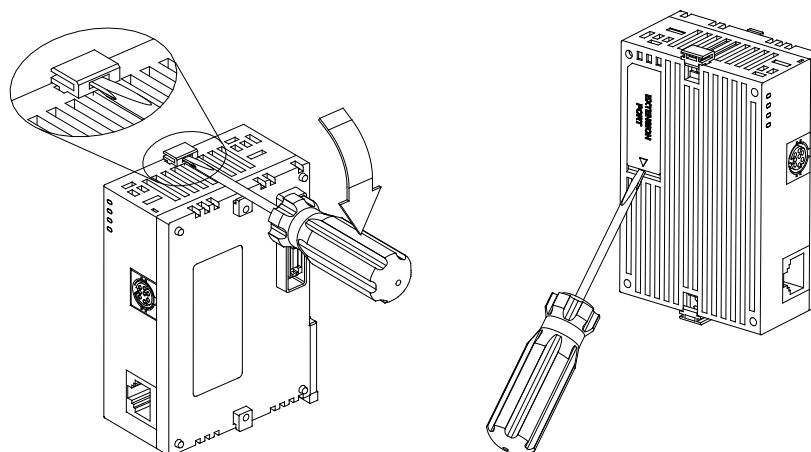

## 3.2 Connecting DVPEN01-SL to the Network:

Connect DVPEN01-SL to the Ethernet Hub by twisted pair cable CAT-5e. DVPEN01-SL has Auto MDI/MDIX function; therefore, DVPEN01-SL does not need to use a crossing cable between the PC and DVPEN01-SL.

Network connections between the PC and DVPEN01-SL:

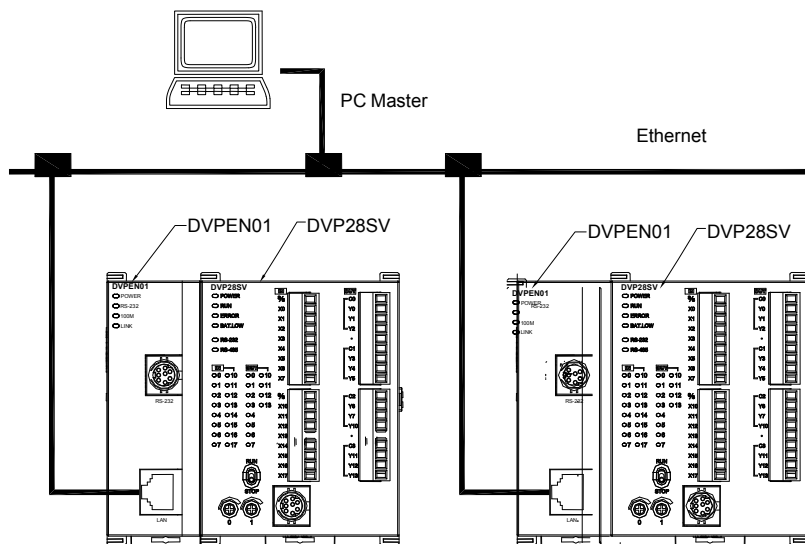

## 4 Control Register (CR)

### 4.1 Control Registers in DVPEN01-SL

CR#		Attribute	Content	Explanation
HW	LW			
	#0	R	Model code	The model code of DVPEN01-SL is set by its system, and can only be read. Model code of DVPEN01-SL=H'6151.
	#1	R	Firmware version	Displaying the current firmware version in hex.
	#2	R	Communication mode	b0: MODBUS TCP mode; b1: data exchange mode
	#3	W	E-mail event 1 trigger	Setting whether to send E-mail 1
	#4	W	E-mail event 2 trigger	Setting whether to send E-mail 2
	#5	W	E-mail event 3 trigger	Setting whether to send E-mail 3
	#6	W	E-mail event 4 trigger	Setting whether to send E-mail 4
	#7	R	Status of E-mail 1, 2	b0~b7: Current status of E-mail 2 b8~b15: Current status of E-mail 1
	#8	R	Status of E-mail 3, 4	b0~b7: Current status of E-mail 4 b8~b15: Current status of E-mail 3
	#9	R/W	E-mail 1 additional message	Filled in by the user, and it will be send by E-mail.
	#10	R/W	E-mail 2 additional message	Filled in by the user, and it will be send by E-mail.
	#11	R/W	E-mail 3 additional message	Filled in by the user, and it will be send by E-mail.
	#12	R/W	E-mail 4 additional message	Filled in by the user, and it will be send by E-mail.
	#13	R/W	Data exchange trigger	Setting whether to send out data in data exchange mode
	#14	R	Status of data exchange	Displaying current status of data exchange.
	#15	R/W	Enabling flag for the RTU mapping	1: Enable 0: Disable Default=0
	#16	R/W	Connection status of the RTU mapping slave	b0: Status of RTU slave 1 b1: Status of RTU slave 2 b2: Status of RTU slave 3 b3: Status of RTU slave 4



CR#		Attribute	Content	Explanation
HW	LW			
	#17	R/W	Data exchange cycle time	The control register is used to set data exchange cycle time. The unit used is a millisecond.
#19	#18	R	Error status of slaves in data exchange	0: No error occurs. 1: An error occurs in data exchange. b0~b15 in CR#19: States of slave 1~16. b0~b8 in CR#18: States of slave 17~24.
#21	#20	R/W	Enable/disable the data exchange in slaves individually	0: Stop. 1: Start to exchange data CR#21 b0~b15: Display the status of the data change in slave 1~16. CR#20 b0~b7: Display the status of the data change in slave 17~24.
	#22	R/W	TCP/IP Retransmission Timeouts (RTO) setting	Unit:ms, range: 20~3000ms, defaults: 20ms
#24~#20		-	Reserved	
#26	#25	R/W	Destination IP address	Destination IP address for data exchange
	#27	-	Function code for a data exchange mode	0 (Default value): The function of function code 17 is enabled. 1: The function of function code 17 is disabled.
	#28	R/W	Destination Slave ID	Destination Slave ID for data exchange
#48~#29		R/W	Data transmission buffer	Buffer for transmitted data in data exchange
#68~#49		R	Data receiving buffer	Buffer for received data in data exchange
#80~#69		-	Reserved	
	#81	R/W	Read address for data exchange	Slave transmission buffer address for data exchange
	#82	R/W	Read length for data exchange	Number of registers for read data
	#83	R/W	Received address for data exchange	Buffer address for the receiving Master in data exchange
	#84	R/W	Written-in address for data exchange	Buffer address for the receiving Slave in data exchange
	#85	R/W	Written-in length for data exchange	Number of registers for data transmission
	#86	R/W	Transmission address for data exchange	Master transmission buffer address for data exchange
	#87	R/W	Mode of setting an IP address	0: Static IP address 1: DHCP
#89	#88	R/W	IP address	Setting an IP address
#91	#90	R/W	Netmask	Setting a netmask
#93	#92	R/W	Gateway IP address	Setting a gateway IP address
	#94	R/W	Enabling the setting of an IP address	Executing the setting of an IP address
	#95	R	Status of setting an IP address	Showing the status of setting an IP address 0: The setting of an IP address is successful. 1: The setting of an IP address fails.
#101~#96		-	Reserved	
	#102	R/W	MC Protocol UDP port	Setting the UDP port of an MC protocol data exchange slave (Default value: 1025)
#110~#103		-	Reserved	
	#111	R/W	8-bit processing mode	Setting the MODBUS TCP master control as 8-bit mode
	#112	R/W	MODBUS TCP Keepalive time	MODBUS TCP Keepalive time (Unit: Second)
	#113	-	Reserved	
	#114	R/W	MODBUS TCP timeout	Setting the MODBUS TCP timeout (Unit: Millisecond)
	#115	R/W	MODBUS TCP trigger	Setting whether to send out data in MODBUS TCP mode
	#116	R/W	MODBUS TCP status	Displaying current status of MODBUS TCP mode
#118	#117	R/W	MODBUS TCP destination IP address	Setting a destination IP address for MODBUS TCP transaction
	#119	R/W	MODBUS TCP data length	Setting the data length for MODBUS TCP transaction
#219~#120		R/W	MODBUS TCP data buffer	Data buffer of MODBUS TCP for storing sending/receiving data

CR#		Attribute	Content	Explanation
HW	LW			
#248~#220		-	Reserved	
	#251	R	Error code	Displaying the errors. See table of error codes in the following section for more information.
#255~#252		-	Reserved	

Symbols "R" refers to "able to read data by FROM instruction"; "W" refers to "able to write data by TO instruction".

## 4.2 Explanations on CR

### CR#0: Model code

Explanations:

1. Model code of DVPEN01-SL=H'4050.
2. You can read the model code in the program to see if the I/O module exists.

### CR#1: Firmware version

Explanations:

The firmware version of DVPEN01-SL is displayed in hex, e.g. H'0100 indicates version V1.00.

### CR#2: Communication mode

Explanations:

Bit No.	Mode	"0"	"1"
b0	MODBUS TCP	Disable	Enable
b1	Data exchange	Disable	Enable

## ■ E-mail Functions

### CR#3~6: E-mail event 1~4 trigger

Explanations:

When the CR is set as "1", E-mail sending will be enabled. After the sending is completed, the CR will automatically be reset as "0". Note: Please trigger by differential instructions.

### CR#7~8: Status of E-mail 1~4

Explanations:

1. CR#7\_b0~b7: current status of E-mail 2; CR#7\_b8~b15: current status of E-mail 1.
2. CR#8\_b0~b7: current status of E-mail 4; CR#8\_b8~b15: current status of E-mail 3.
3. Table of E-mail statuses

CR value	E-mail status
0	Not been sent
1	Being processed
2	The sending of the E-mail is successful.
10	Fail to connect to the SMTP server.
11	Incorrect recipient E-mail address
12	SMTP server communication error
13	Exceeding the max. number of TCP connection
3~9, 14~255	Reserved

**CR#9~12:** E-mail 1~4 additional message

Explanations:

The user fills in the code, and the code will be stored in the title of the E-mail and sent out with the E-mail.

■ **Data Exchange**

**CR#13:** Data exchange trigger

Explanations:

CR#13	Execution
0	The data in data exchange area is not transmitted.
1	The data in data exchange area is transmitted.
2	The data exchange is executed continuously. If the value in CR#13 is 0, the data exchange will stop. Setting: Program Control in the Enable Condition drop-down list box is selected. (Please refer to section 5.6.)
3	The data exchange is executed once. After the data exchange is executed, the value in CR#13 will automatically become 0. Setting: Program Control in the Enable Condition drop-down list box is selected. (Please refer to section 5.6.) (V2.06 and later versions support the function.)

**CR#14:** Data exchange status

Explanations:

When the CR is set as “0”, the data have not yet been received. When the CR is set as “1”, the data exchange is in progress. When the CR is set as “2”, the data exchange is successful. When the CR is set as “3”, the data exchange fails.

CR value	Status
0	Data have not yet been received.
1	Data exchange is in progress.
2	Data exchange is successful.
3	Data exchange fails.

**CR#17:** Data exchange cycle time

Explanations:

The control register is used to set the minimum data exchange cycle time. The unit used is a millisecond. The default value is 0.

**CR#19~18:** Error status of slaves in data exchange

Explanations:

b0~b15 in CR#19: States of slave 1~16.

b0~b7 in CR#18: States of slave 17~24.

If the bit corresponding to the state of a slave is 1, an error occurs in the slave.

## CR#21~20: Enable/disable the data exchange in slaves individually

Explanations:

Use the data exchange function from the DCISoft to start the data exchange in slaves individually.

CR#21 b0 ~ b15: The status of the data change in slave 0~16.

CR#20 b0 ~ b7: The status of the data change in slave 17~24.

When the state is 1, the data exchange process has started.

CR number and the corresponding data exchange format table:

CR21															
b15	b14	b13	b12	b11	b10	b9	b8	b7	b6	b5	b4	b3	b2	b1	b0
No.16	No.15	No.14	No.13	No.12	No.11	No.10	No.9	No.8	No.7	No.6	No.5	No.4	No.3	No.2	No.1

CR20															
b15	b14	b13	b12	b11	b10	b9	b8	b7	b6	b5	b4	b3	b2	b1	b0
Reserve								No.24	No.23	No.22	No.21	No.20	No.19	No.18	No.17

## CR#22 : TCP/IP Retransmission Timeouts (RTO) setting

Explanations:

When the TCP/IP packet transmission time is over the RTO setting value, it will be resent.

Unit: ms, range: 20~3000ms, default: 20ms

## CR#25~26: Destination IP address

Explanations:

To set the slave IP address for data exchange manually, write "0" into CR#28 first before setting the destination IP address. For example, if the user wants to set the destination IP address to 192.168.0.2, write H'0002 to CR#25 and H'C0A8 to CR#26. (K192=H'C0, K168=H'A8, K0=H'00, K2=H'02).

## CR#27: Function code for a data exchange mode

Explanations:

0: Using the function code "0x17" for the reading of data and the writing of data

1: Using the function code "0x03" for the reading of data; using the function code "0x06" for the writing of a single piece of data; using the function code "0x10" for the writing of multiple pieces of data

## CR#28: Destination slave ID

Explanations:

When you set the Slave ID (i.e. K1~K255) for data exchange, DVPEN01-SL will automatically search for the corresponding IP address from the slave IP address list. For example, if the ID is set as "0", the value in CR#25 and #26 will be regarded as the destination IP address.

**CR#29~48: Data transmission buffer**

Explanations:

Storing the data to be transmitted to the remote MPU.

**CR#49~68: Data receiving buffer**

Explanations:

Storing the data received from the remote MPU.

**CR#81: Read address for data exchange**

Explanations:

Setting manually the MODBUS address of the register for Slave data exchange

Only register address is allowed (e.g. D0=H'1000).

**CR#82: Read length for data exchange**

Explanations:

The number of receiving registers (K1~K100) in data exchange.

**CR#83: Read length for data exchange**

Explanations:

Setting the MODBUS address of the register for Master data exchange

**CR#84: Written-in address for data exchange**

Explanations:

Setting manually the MODBUS address of the register for Slave data exchange

**CR#85: Written-in address for data exchange**

Explanations:

The number of transmission registers (K1~K100) in data exchange

**CR#86: Transmission address for data exchange**

Explanations:

1. Setting the MODBUS address of the register for Master data exchange.
2. Example: Write H'1000 (D0) into CR#81, K1 into CR#82, and H'1064 (D100) into CR#83. If the data exchange is successful, the value in D0 of the Slave will be written into D100 of the MPU. Or write H'1002 (D2) into CR#84, K4 into CR#85, and H'1008 (D8) into CR#86. If the data exchange is successful, the value in D8~D11 of the Master will be written into D2~D5 of the Slave. Both sending and receiving can be executed at the same time. When the values in CR#82 and #85 are both "0", DVPEN01-SL will use the default registers

(CR#29~CR#68) and number of registers (K20).

## ■ Setting an IP address

### CR#87: Mode of setting an IP address

Explanations:

0: Static IP address

1: DHCP

### CR#88~89: IP address

Explanations:

The control registers are used to set an IP address. If an IP address is 192.168.1.5, the value in CR#88 will be H'0105, and the value in CR#89 will be H'C0A8.

### CR#90~91: Netmask

Explanations:

The control registers are used to set a netmask. If a netmask is 255.255.255.0, the value in CR#90 will be H'FF00, and the value in CR#91 will be H'FFFF.

### CR#93~92: Gateway IP address

Explanations:

The control registers are used to set a gateway IP address. If a gateway IP address is 192.168.1.1, the value in CR#92 will be H'0101, and the value in CR#93 will be H'C0A8.

### CR#94: Enabling the setting of an IP address

Explanations:

If the value in CR#94 is 1, the setting of an IP address will be enabled. After the setting is complete, the value in CR#94 will automatically become 0.

### CR#95: Status of setting an IP address

Explanations:

The control register is used to show the status of setting an IP address. If the value in CR#95 is 0, the setting of an IP address is successful. If the value in CR#95 is 1, the setting of an IP address is being executed.

## ■ Sending MODBUS TCP Instruction

### CR#111: 8-bit processing mode

Explanations:

Setting the MODBUS TCP transmission mode

When the CR value is set as "0"→16-bit mode; when the CR value is set as "1"→8-bit mode.

## CR#112: MODBUS client Keepalive time-out

Explanations:

CR#112 is the TCP Keepalive timeout for MODBUS TCP connection. (Unit: Second)

Default: 30s

If the connection idle time becomes longer than the keep-alive time-out, DVPEN01-SL will cut off the idle connection.

## CR#114: MODBUS TCP timeout

Explanations:

Setting the communication time-out (in ms) for MODBUS TCP mode

## CR#115: MODBUS TCP trigger

Explanations:

When the CR value is set as "1", MODBUS TCP will be triggered. After the data transmission is completed in MODBUS TCP mode, the CR value will automatically be reset to "0". Please trigger by differential instructions.

## CR#116: MODBUS TCP status

Explanations:

Displaying the current communication status of MODBUS TCP mode

When the CR value is set as "0"→the data have not yet been received; when the CR value is set as "1"→the data exchange is in progress; when the CR value is set as "2"→the data exchange is successful; when the CR value is set as "3"→the data exchange fails.

CR value	Data exchange status
0	The data have not been received.
1	The data exchange is in progress.
2	The data exchange is successful.
3	The data exchange fails.

## CR#117~118: MODBUS TCP destination IP address

Explanations:

Setting the destination IP address in MODBUS TCP mode

See explanations on CR#70 and #71 for more information.

## CR#119: MODBUS TCP data length

Explanations:

Setting the length of communication data in MODBUS TCP mode

Length for 8-bit mode: K1~K100

Length for 16-bit mode: K1~K200.

## CR#120~219: MODBUS TCP data buffer

Explanations:

Buffer for transmitted/received data in MODBUS TCP mode

## CR#251: Error code

Explanations:

Table of error codes:

Bit No.	Error
b0	The network is not yet connected.
b1	Incorrect IP address setting
b2	CR#13 is set as "transmitting data", but the data exchange is forbidden.
b3	CR#13 is set as "transmitting data", but the data exchange mode has not yet been enabled.
b4	NTP-Server connection fails.
b7	SMTP-Server connection fails.
b8	DHCP has not obtained the correct network parameter.

## ■ RTU Mapping

### CR#15: Enabling glag for the RTU mapping

Explanations:

1: Enable

0: Disable

Default=0

Firmware V2.0 and later versions support the RTU mapping.

### CR#16: Connection status of the RTU mapping slave

Explanations:

b3~b0 display the connection status of RTU slave. The connection may encounter some problems when any of the bits becomes 0. Firmware V2.0 and later versions support RTU mapping.

b0: Status of RTU slave 1

b1: Status of RTU slave 2

b2: Status of RTU slave 3

b3: Status of RTU slave 4

## 4.3 Numbering of Left-Side Modules

After DVPEN01-SL is installed properly, you need to compile the PLC program to control the special I/O module. PLC offers FROM instruction (for reading) and TO instruction (for writing) to control the control registers (CR) in the special I/O module.

Numbering of the modules: Every special I/O module connected to PLC MPU has a No. to allow you to know which module is which when compiling the PLC program. The first special I/O module attached at the left hand side of the PLC MPU is numbered as K100, the second as K101, the third K102, and so on.



## 5 Setting the Software

This section gives instructions on how to set DVPEN01-SL by DCISoft and explanations on each setup page. Before you start a setup page, you have to select **Ethernet** in the **Communication Setting** window. Next, you can search by IP address or use Auto-Search. You also can open the setup page for DVPEN01-SL by RS-232. DVPEN01-SL is set by UDP port 20006; therefore, you have to be aware of the relevant settings of the firewall.

### 5.1 Setting Communication & Searching for Modules

#### ■ Communication settings

1. Open DCISoft in your PC and click on **Communication Setting**.

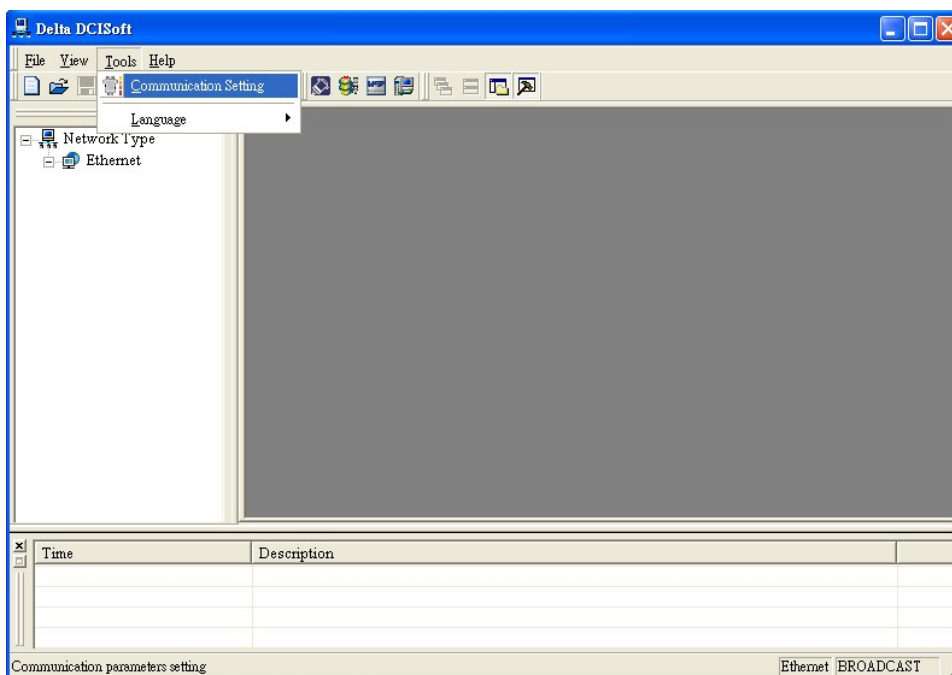

2. Select **Ethernet** as the transmission type.

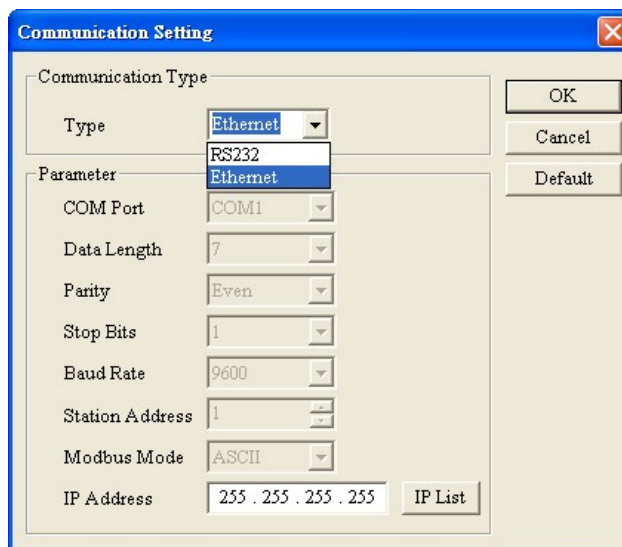

## ■ Broadcast search

1. Click **Search** in DCISoft to search for all Delta Ethernet products on the network. The window on the left hand side shows the models found, and the window on the right hand side displays the device list of all models.

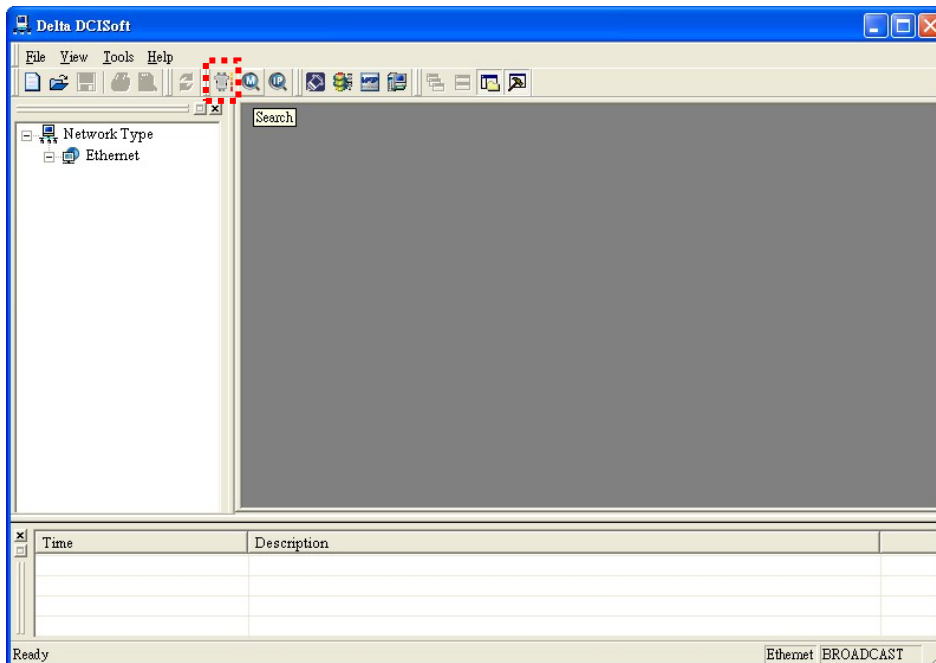

2. Click a model on the left hand side, and you will see the device list of the model selected on the right hand side. Click the device to be set to enter the setup page.

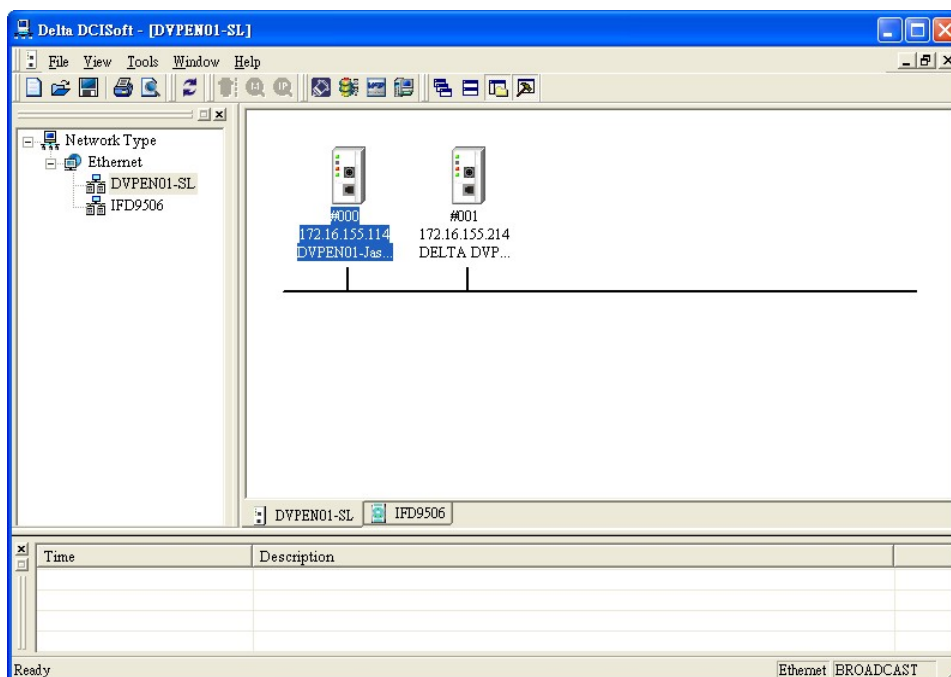

3. You will see the basic setup page as follow.

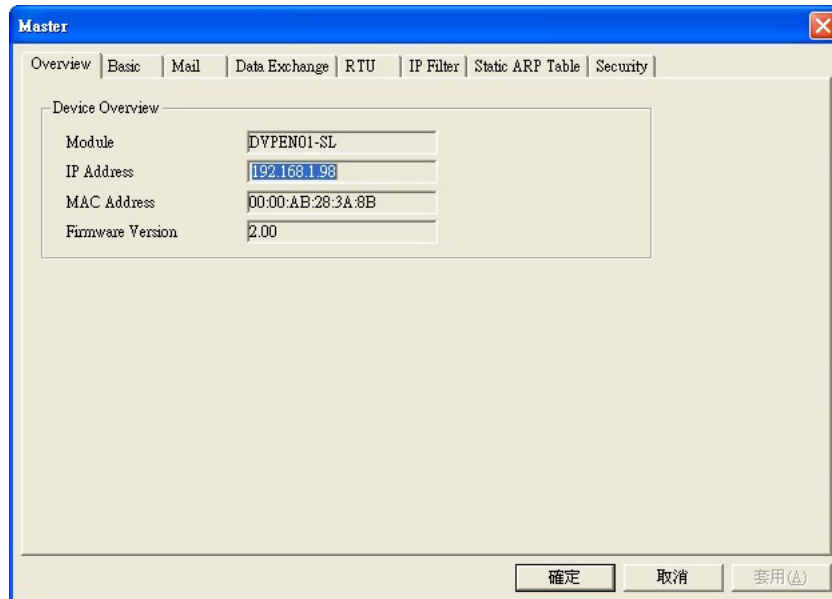

## ■ Designating a model to search

1. Right click **Ethernet** on the left hand side window and click **Configure** to designate a model to search for.

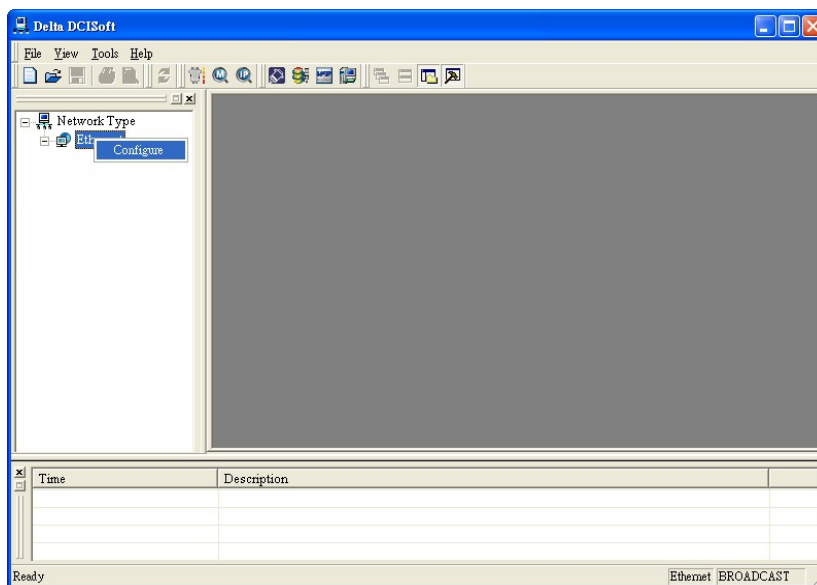

2. After configure a model, select the **DVPEN01-SL** checkbox and click **OK** to auto-search for DVPEN01-SL modules on the network.

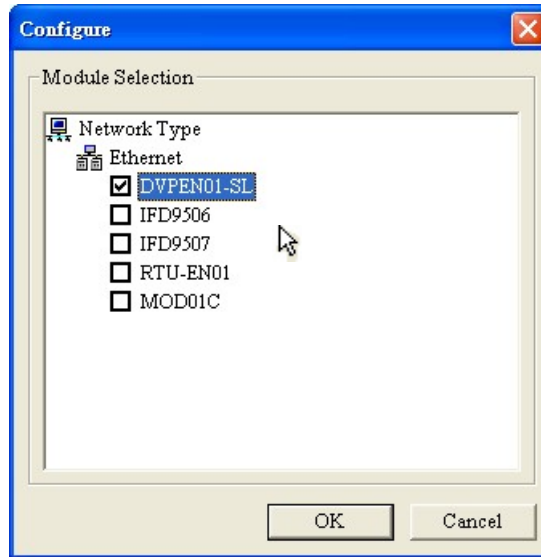

3. List of the current DVPEN01-SL modules

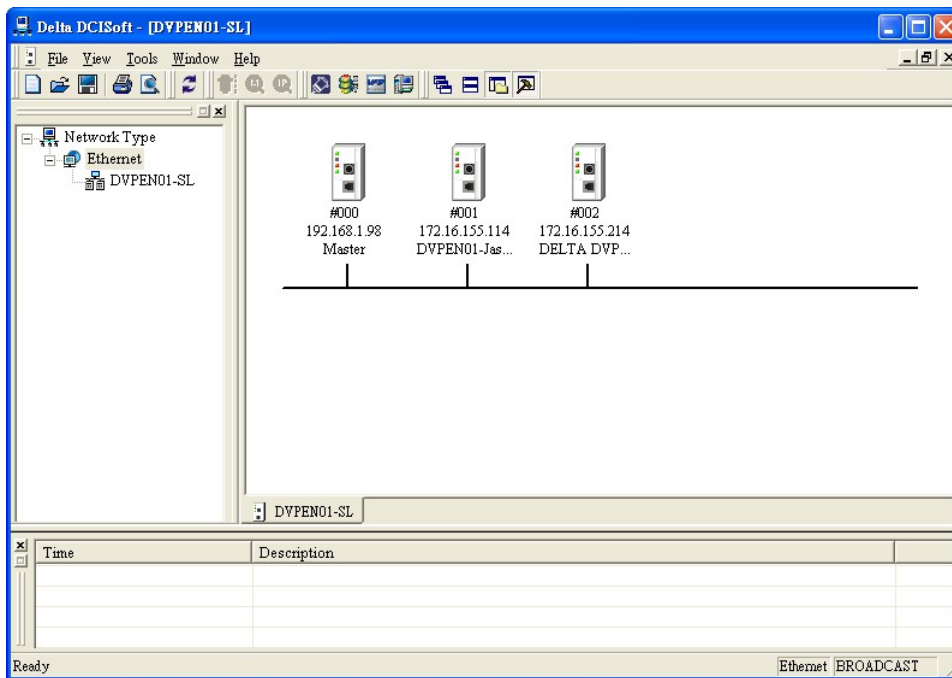

## ■ Searching by an IP address

1. Select **Ethernet** in the **Communication Type** section, and enter the IP address. Click **OK**.

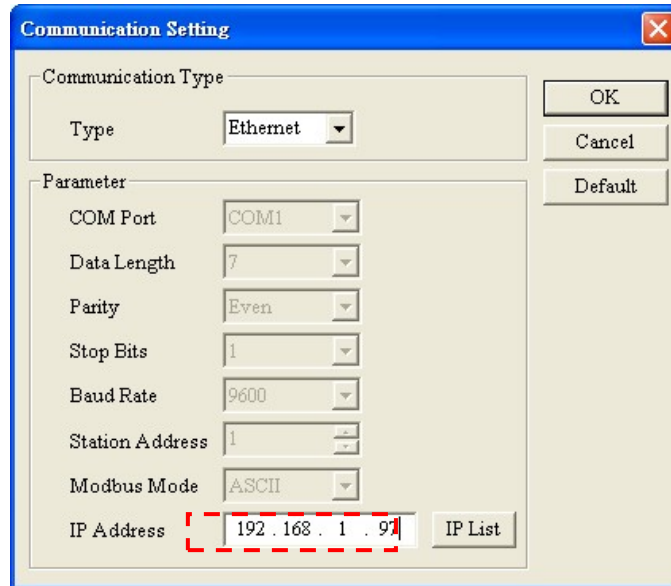

2. Click **IP Search** to start searching for the designated IP address.

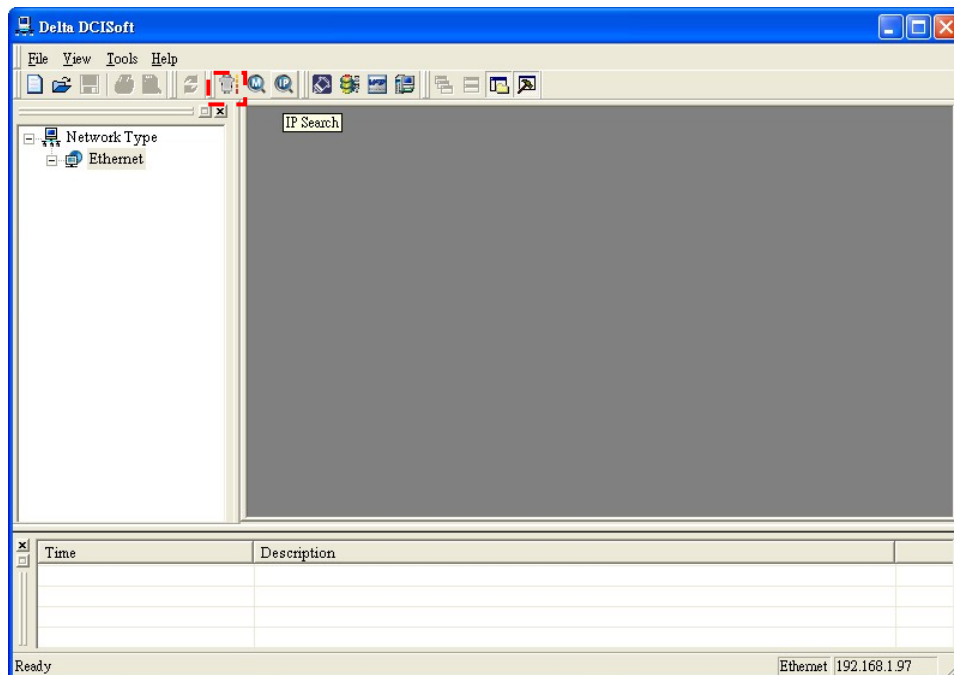

3. The DVPEN01-SL module found will be displayed in the right hand side window. Double click it to enter the setup page.

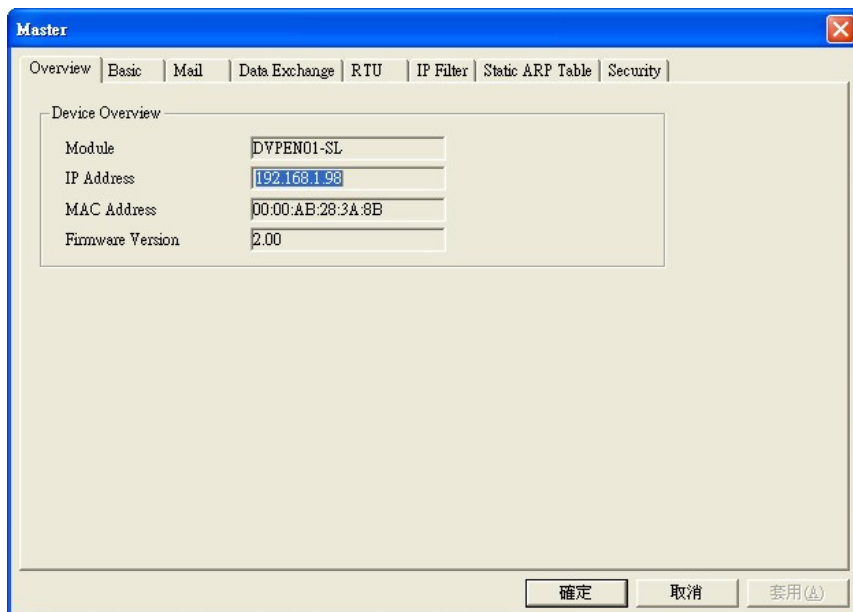

## ■ Opening the DVPEN01-SL setup page by RS-232

1. Select **RS232** as the transmission type in the **Communication Setting** window. You will have to designate a communication port. When DVPEN01-SL is searched by RS-232, you do not need to set the parameters (i.e. data length, parity, stop bits and baud rate).

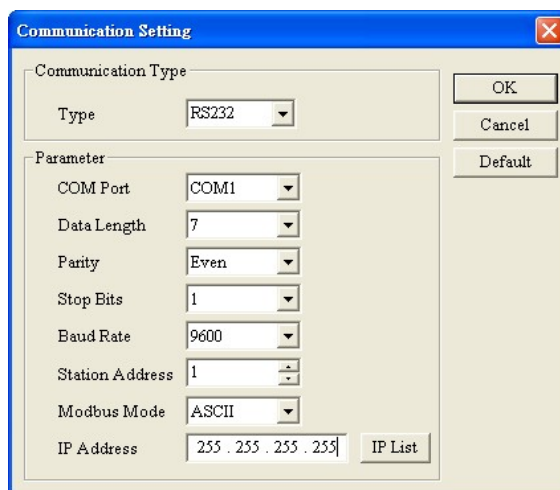

- After setting the communication port, click **Search**. If the searching is successful, the setup page for DVPEN01-SL will open automatically.

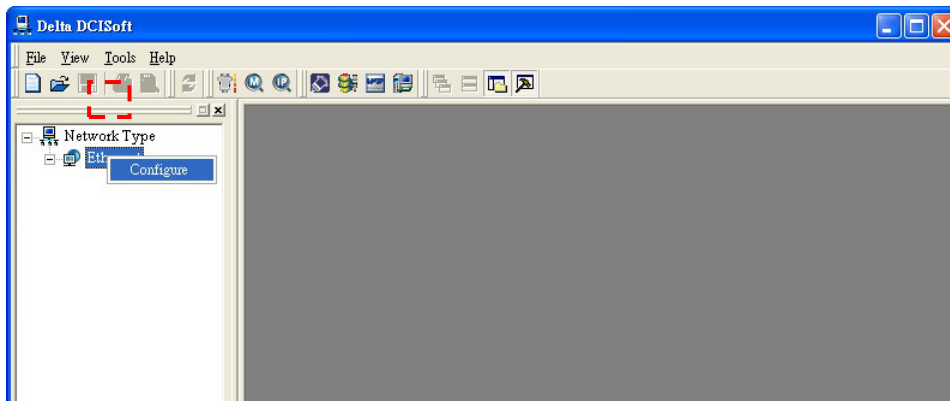

## 5.2 Basic Settings

The basic settings include parameters as module name, language, enabling MODBUS TCP and time correction.

### Basic settings

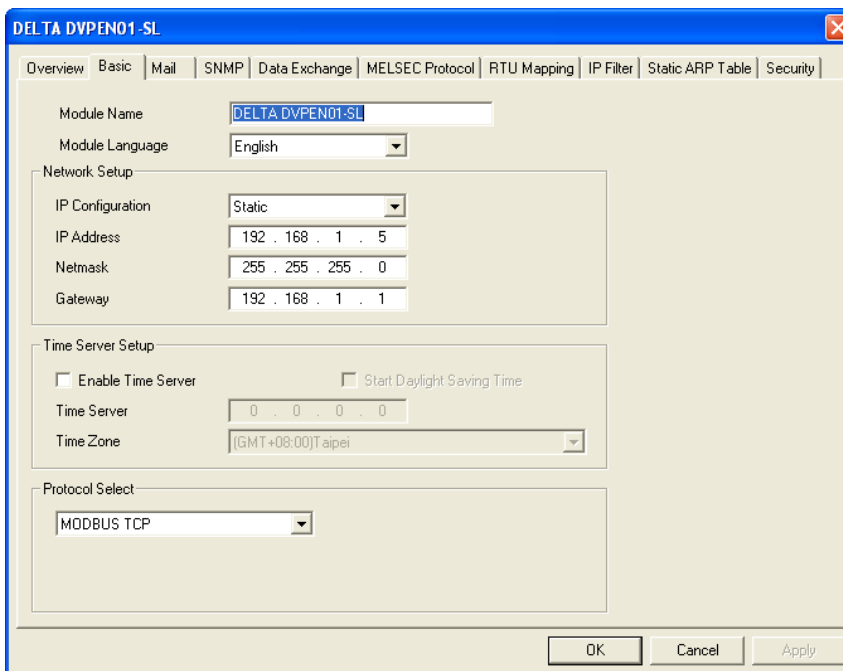

#### 1. Module Name

There can be many DVPEN01-SL modules in the network. Thus, you can set a module name for each module to identify the module when you need to use them.

#### 2. Module Language

You can select a language for each module name, and the windows will be displayed in the selected language.

#### 3. Enable MODBUS TCP

To enable or disable MODBUS TCP. When MODBUS TCP is disabled, WPLSoft will not be able to upload or download.

#### 4. Enable Time Server

DVPEN01-SL adopts NTP (Network Time protocol), which means it can acquire correct time automatically from the time server in the network and correct the RTC in the MPU every fixed period of time to ensure

correct time in the MPU. The **Enable Time Server** is unselected by default.

## 5. Start Daylight Saving Time

Daylight Saving Time; also known as summer time is a conventional local time adopted by many countries in the world on a seasonal basis. Most commonly DST is obtained by adjusting the official local time forward, by one hour, for the spring, summer, and early autumn periods. Daylight Saving Time is not implemented in Taiwan; therefore, you do not need to check this item.

## 6. Time Server

IP address of the time server. You can acquire correct time from the time server to correct the time in the MPU.

## 7. Time Zone

A time zone is a region of the Earth that has adopted the same standard time, usually referred to as the local time. Most adjacent time zones are exactly one hour apart, and by convention compute their local time as an offset from Greenwich Mean Time (see also UTC). Standard time zones can be defined by geometrically subdividing the Earth's spheroid into 24 lunes (wedge-shaped sections), bordered by meridians each 15° of longitude apart. The local time in neighboring zones is then exactly one hour different. However, political and geographical practicalities can result in irregularly shaped zones that follow political boundaries or that change their time seasonally (as with daylight saving time), as well as being subject to occasional redefinition as political conditions change. You should choose the Time zone that you are.

## 8. Protocol Select

DVPEN01-SL supports MODBUS TCP and the Mitsubishi MELSEC protocol in a UDP mode. The default setting is MODBUS TCP.

## 5.3 Network Settings

The first step for all the network equipment to connect to the network is to have its own IP address (Internet Protocol). The IP address is like a number for every network equipment to be identified in the network.

### ■ Setting the static IP address of the PC

1. Enter the **Control Panel** window.→ Enter the **Network Connections** window.→ Click on **Local Area Connection**.

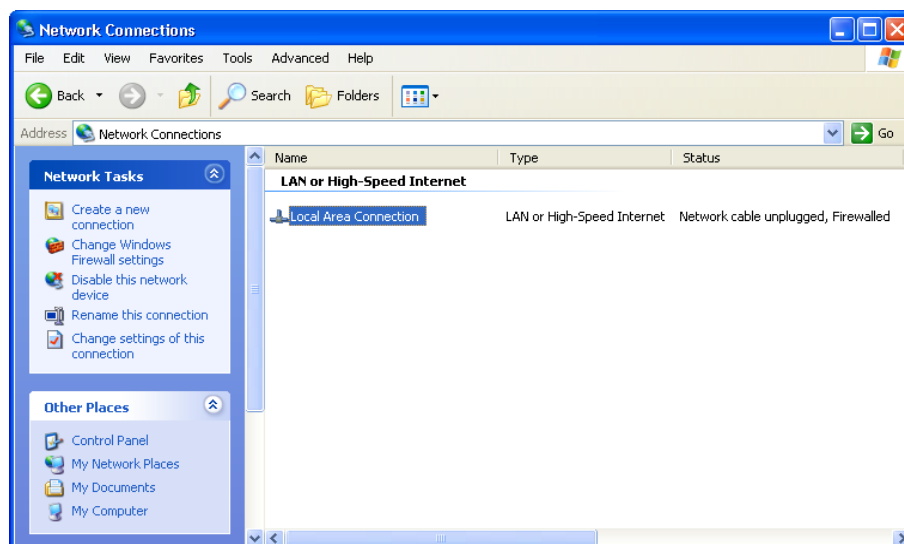



2. You will see the **Local Area Connection Status** window. Click on **Properties**.

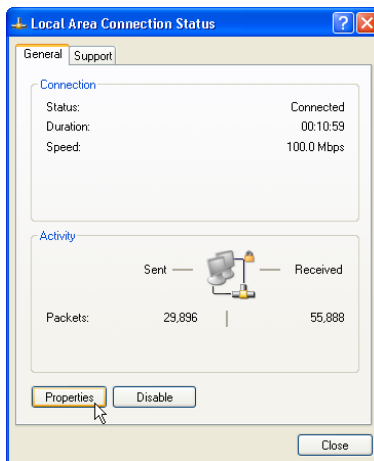

3. Click on **Internet Protocol (TCP/IP)**.

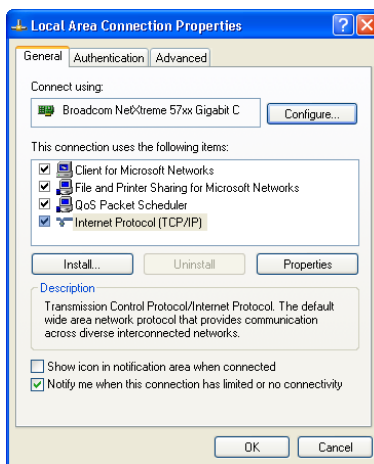

4. Enter 192.168.0.1 into the **IP address** box. Click on **OK** to complete the IP address setting of the PC.

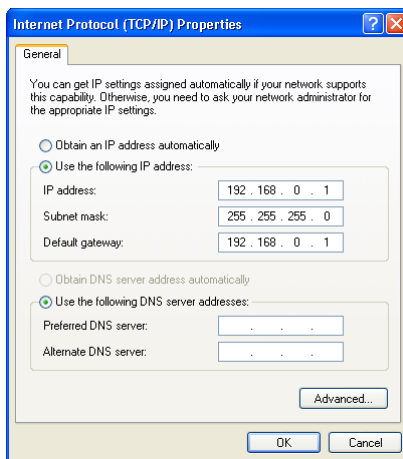

## ■ Setting the DVPEN01-SL network

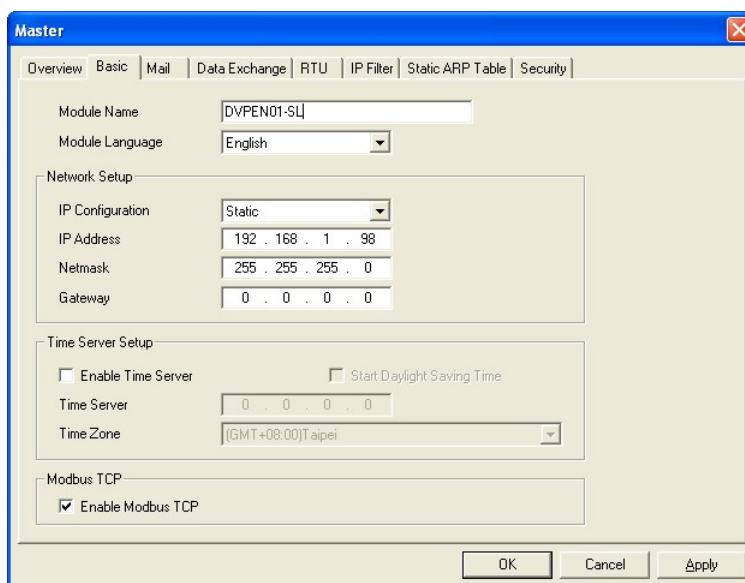

### 1. IP Configuration

There are two types of IP address, static IP addresses and DHCP.

Static IP address: Preset or manually modified by the user.

DHCP: Automatically updated by the server. There has to be a server in the LAN.

IP	Explanation
Static	The user enters the IP address, subnet mask and gateway.
DHCP	DHCP server offers the IP address, subnet mask and gateway.

### 2. IP Address

IP address is the location of the equipment in the network. Every equipment connected to the network has to have an IP address. Incorrect IP address will result in connection failure on the equipment or even other equipment. Ask your ISP for questions about IP address setup. The default IP address for DVPEN01-SL is 192.168.1.5.

### 3. Netmask

Subnet mask is an important parameter for setting the subnet, used for seeing if the destination IP address and the local equipment are in the same subnet. If not, the equipment will send the packet to the gateway, and the gateway will send the packet to another subnet. Incorrect setting may cause the destination equipment unable to communicate with DVPEN01-SL. To see if your setting is correct, conduct bitwise AND operations between your IP address and subnet mask and destination IP address and subnet mask. If the two values obtained are the same, the two IP addresses are in the same subnet. The default subnet mask of DVPEN01-SL is 255.255.255.0.

### 4. Gateway

Gateway is the gate for two different subnets, allowing the two ends in different subnets to communicate. For example, if the LAN has to be connected to WAN, it will need a gateway to bridge the communication. The IP address of the gateway has to be in the same subnet as DVPEN01-SL. The default gateway IP address of DVPEN01-SL is 192.168.1.1.

## 5.4 Setting E-mails

E-mail is the abbreviation of electronic mail, which transmits mails through the network. DVPEN01-SL has E-mail functions for the user to pre-save a segment of text messages, which can be a descriptive message or error message, into the subject of the E-mail. When the E-mail is triggered, DVPEN01-SL will send the messages to the user by E-mail.

DVPEN01-SL offers 4 sets of E-mail information, and you can self-define the register or bit information to be read. When the trigger occurs, DVPEN01-SL will add the set register or bit present value read to the E-mail. Every piece of E-mail information is able to contain the present values in the up to 100 consecutive registers.

### ■ Setting mails

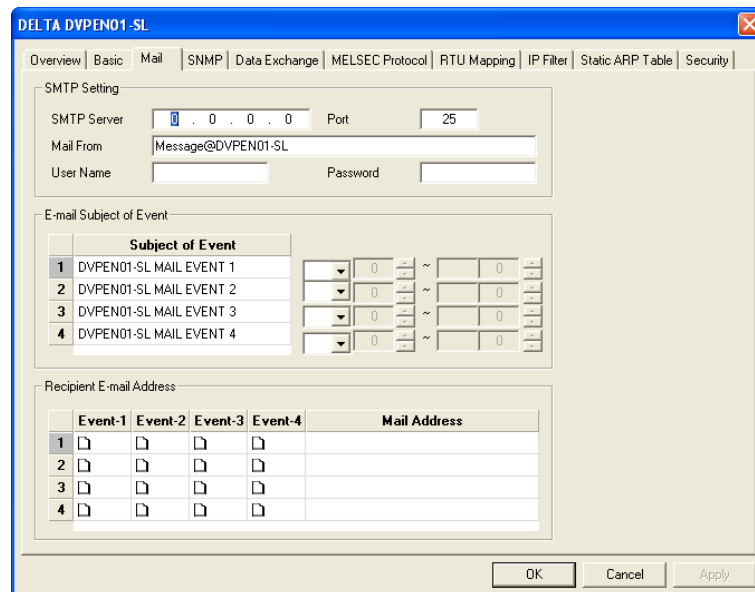

#### 1. SMTP Setting

The E-mail will first be sent to SMTP server, and SMTP server will send it to the designated address. For example, assume there is an E-mail to be sent to [test@delta.com.tw](mailto:test@delta.com.tw), and the SMTP server is 172.16.144.121. The E-mail will be sent to SMTP server first, and the server will further send it to the recipient [test@delta.com.tw](mailto:test@delta.com.tw).

The setting boxes are described below.

- **SMTP Server:** Setting the IP address of the SMTP server
- **Port:** Entering the port of the SMTP server (The default value is 25.)
- **Mail From:** Setting the mail address used to send E-mails (63 characters at most can be entered.)
- **User Name:** Account used to log in to the SMTP server
- **Password:** Password used to log in to the SMTP server

#### 2. E-mail Subject of Event

You can enter text message in the column, and the message will be placed in the subject of the E-mail and sent to the recipient. DVPEN01-SL is able to contain 1~4 E-mail subjects (max. 63 English characters are allowed).

You can select additional information for the E-mail. Every E-mail is able to contain the present values in 100 consecutive registers.

#### 3. Recipient E-mail Address

You can enter 4 E-mail addresses. One mail can be sent to 4 addresses (max. 63 English characters are

allowed).

#### 4. Selecting recipients:

After you have set all the parameters for the E-mail, you will need to select recipients. The E-mail will be sent to the designated recipients when the E-mail is triggered. To trigger the E-mail, set the value is CR#3~CR#6 to "1".

#### 5. See section 6.8" for more details.

#### Notes:

To correctly send out E-mails, there has to be a SMTP server in the network. When we send out an E-mail, the mail will be sent to SMTP server first, and the server will further send the mail to the designated address.

## 5.5 SNMP

SNMP is a simple network management function. Users can read and control the registers in a PLC by means of a SNMP network management tool. (DVPEN01-SL version 2.06 and above support this function.)

### ■ Setting

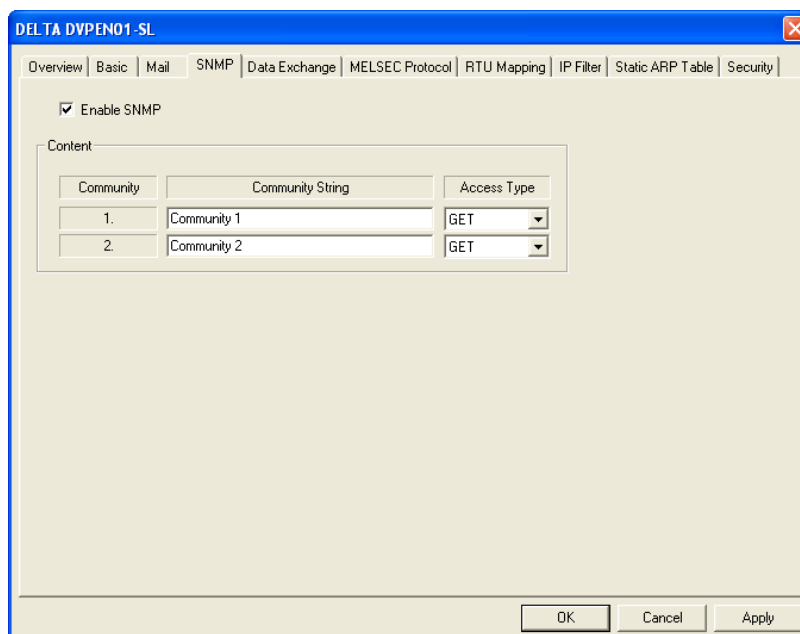

#### 1. Enable SNMP

Users can disable/enable the SNMP function by unselecting/selecting the **Enable SNMP** checkbox.

#### 2. Community

Users can set two communities. The relevant setting boxes are described below.

- **Community String:** Name given to the community which is connected (63 English characters at most can be entered.)
- **Access Type:** Users can select **GET** (reading) or **GET/SET** (reading/writing).

## 5.6 Data Exchange

DVPEN01-SL is able to designate a data exchange area for PLC MPUs to exchange and synchronize their data.

### Setting data exchange

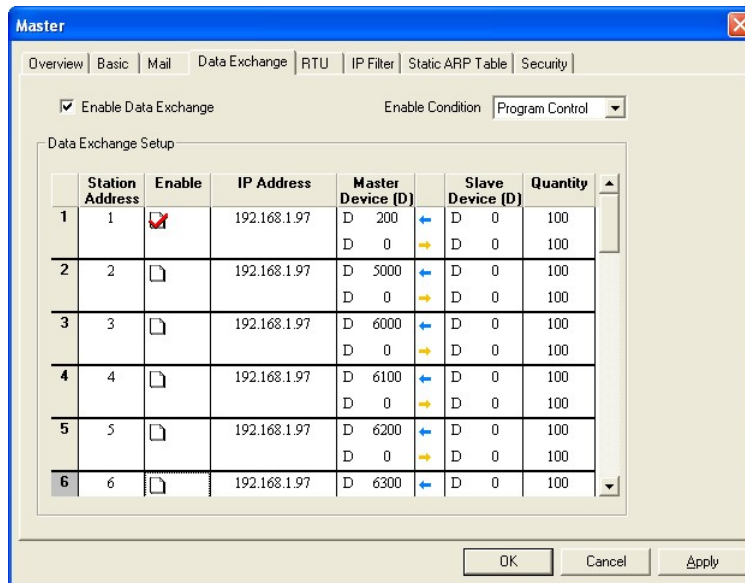

#### 1. Enable Data Exchange

Check/uncheck the station addresses to enable/disable data exchange. The station address can be selected individually. For example check Station Address 1 to enable the data exchange and uncheck the Station Address 2 to disable the data exchange as the the image shown below. This can also be achieved by setting up CR20~21. Please refer to chapter 4.2 in this manual for more information.

Station Address	Enable	IP Address	Master Device (D)	Slave Device (D)	Quantity
1	<input checked="" type="checkbox"/>	192.168.1.97	D 200 D 0	D 0 D 0	100
2	<input type="checkbox"/>	192.168.1.97	D 5000 D 0	D 0 D 0	100

#### 2. Enable Condition

You can select **Always Enable** or **Program Control**. If **Always Enable** is selected, DVPEN01-SL will execute data exchange continuously until the setting in DCISoft is changed. If **Program Control** is selected, DVPEN01-SL will execute data exchange according to the program setting (CR#13=2: Executing data exchange; CR#13=0: Stopping executing data exchange).

#### 3. Station Address and IP Address

You have to enter the IP address of DVPEN01-SL at the other end. For example, if you would like DVPEN01-SL to exchange data with 192.168.0.1, set No. 1 as 192.168.0.1. When the data are being exchanged, if the value in CR#28 is H'0001, the data will be exchanged with 192.168.0.1.

#### 4. Master Device, Slave Device, and Quantity.

Reading (←): Start address of the master's receiving register ← Start address of the slave's sending register  
 Writing (→): Start address of the master's sending register → Start address of the slave's receiving register  
 When data exchange is executed, DVPEN01-SL executes the writing (→) first before the reading (←).  
 Quantity: A slave is able to send and receive the data in 100 consecutive registers at the same time.

► For data exchange, D register is parted into 2 sections, D0000~D4095 and D4096~D9999. Please DO NOT use different sections for the consecutive sent and received data (start address + number of data).

#### 5. See section 6.9~section 6.11 for more details.

## 5.7 MELSEC Protocol

DVPEN01-SL can communicate with Mitsubishi devices by means of the MELSEC protocol. It can support the communication with a master and the communication with slaves simultaneously. Only UDP communication is allowed. (DVPEN01-SL version 2.10 and above support this function.)

- Setting the MELSEC protocol mode

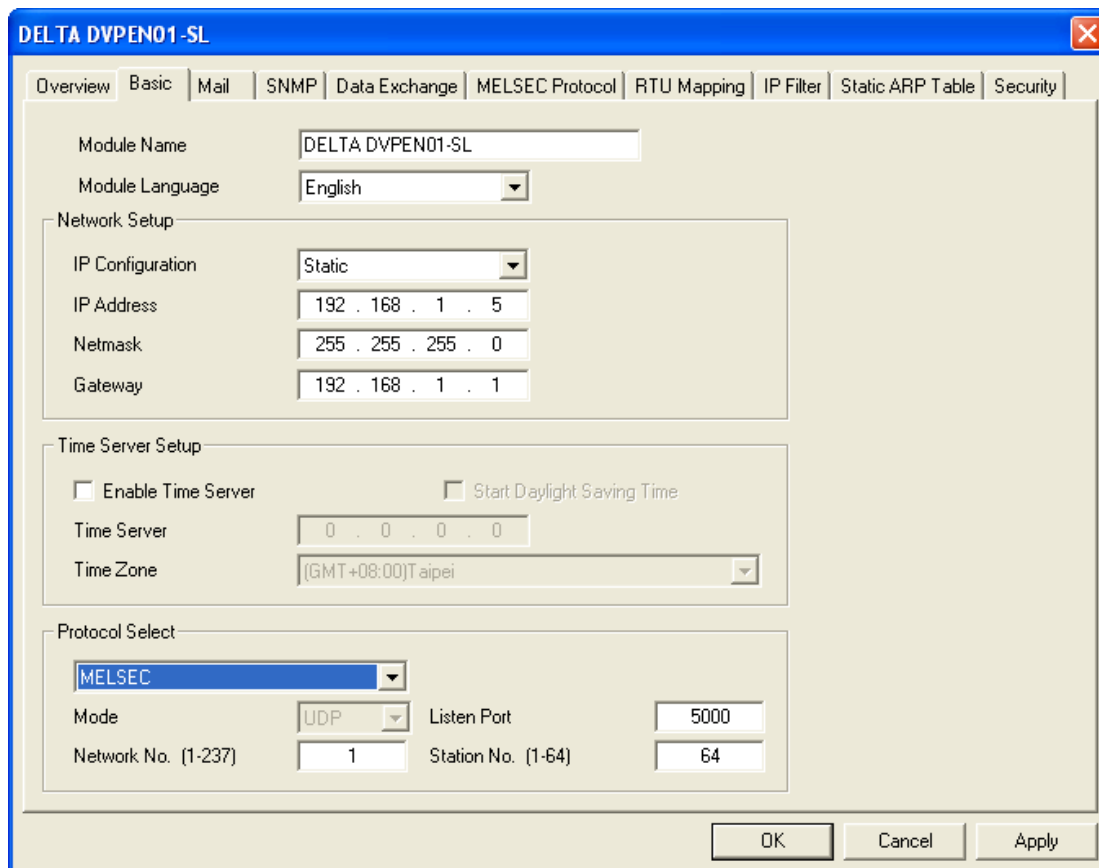

1. **Protocol Select:** Setting the MELSEC function
2. **Listen Port:** Setting the communication port of the MELSEC protocol slave
3. **Network No./Station No.:** Setting the network number and the station number of the MELSEC protocol device

■ Setting the MELSEC protocol data exchange

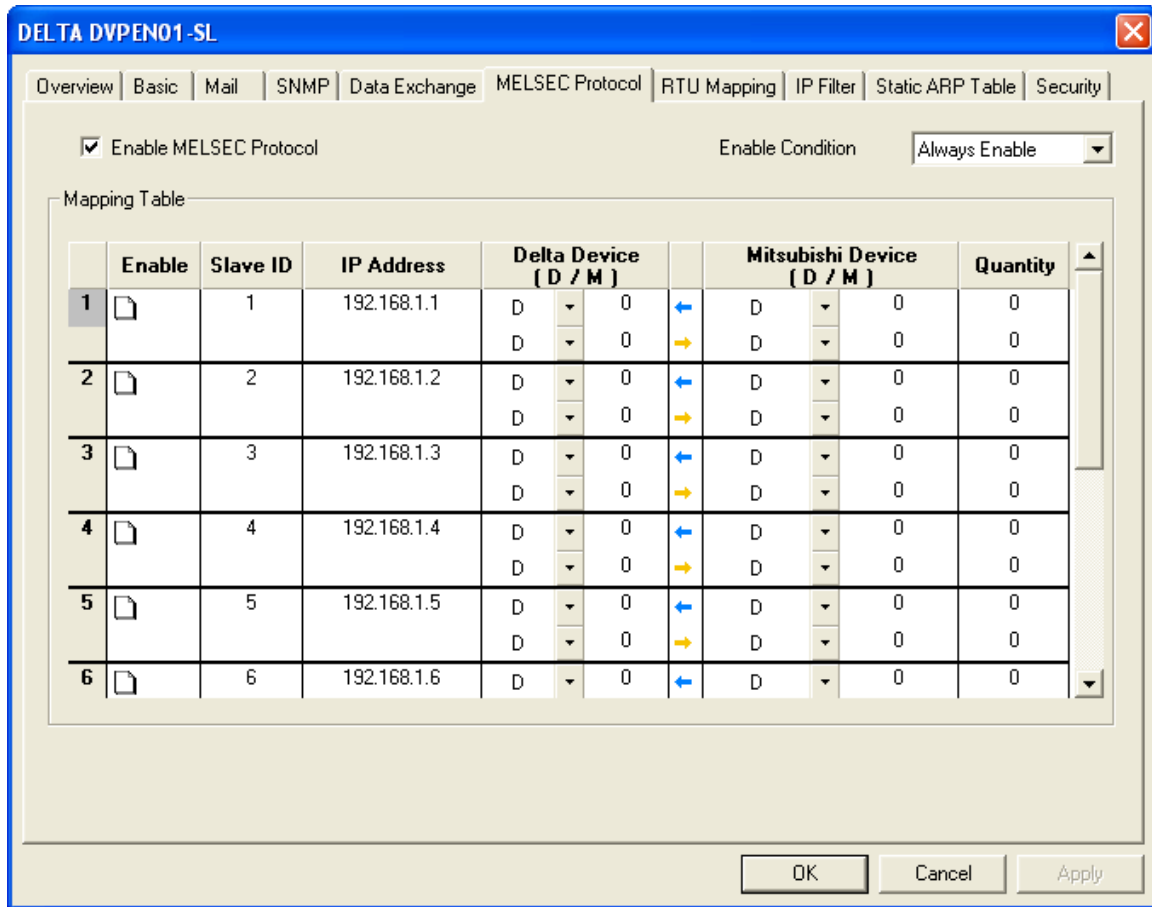

1. **Enable MELSEC Protocol**

Users can disable/enable the MELSEC protocol by unselecting/selecting the **Enable MELSEC Protocol** checkbox. After the MELSEC protocol is enabled, data exchange will be carried out according to the data which has been set.

2. **Enable Condition**

Users can select **Always Enable** or **Program Control**. If **Always Enable** is selected, DVPEN01-SL will execute data exchange continuously until the setting in DCISoft is changed. If **Program Control** is selected, DVPEN01-SL will execute data exchange according to the program setting (CR#13=2: Executing data exchange; CR#13=0: Stopping executing data exchange).

3. **Slave ID and IP address**

Users need to type the IP address and the slave ID of a Mitsubishi device which supports the MELSEC protocol. For example, the users can type the slave ID 1 and the IP address 192.168.0.1. If data exchange is executed, DVPEN01-SL will exchange data with the device whose slave ID is 1 and whose IP address is 192.168.0.1 by means of the MELSEC communication.

4. **Delta Device, Mitsubishi Device, and Quantity**

Reading (←): Start address of the Delta device's receiving register ← Start address of the Mitsubishi device's sending register

Writing (→): Start address of the Delta device's sending register → Start address of the Mitsubishi device's receiving register

When data exchange is executed, DVPEN01-SL executes the writing (→) first before the reading (←).

Quantity: A slave is able to send and receive the data in 100 consecutive registers at the same time.

- Please refer to section 6.15 for more information.

## 5.8 RTU

Use the RTU function to conduct mapping between Delta's network modules DVPEN01-SL and RTU-EN01. Set the mapping information first, and you will be able to use WPLSoft in DVPEN01-SL to save and retrieve the mapped bit (M) and register (D) in order to operate the remote RTU-EN01.

### ■ Setting the RTU mapping

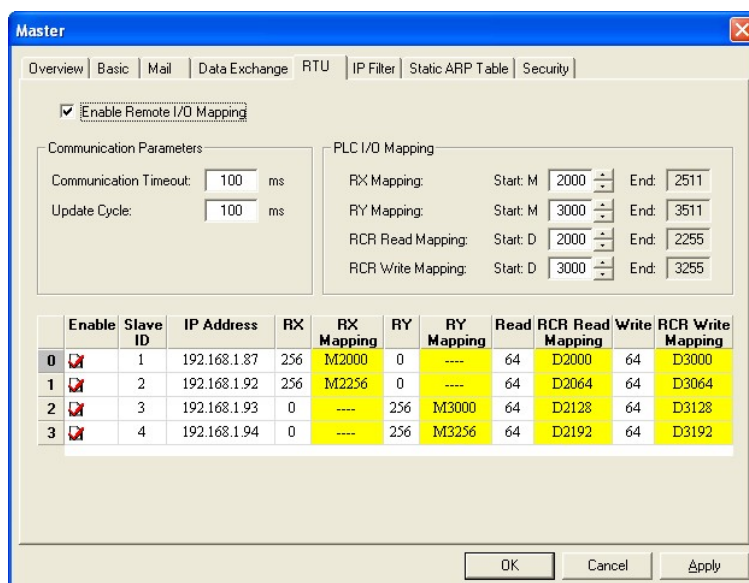

- 1. Enable Remote I/O Mapping**

Users can select the **Enable Remote I/O Mapping** checkbox. After the checkbox is selected, the network module used will be mapped onto RTU-EN01 according to the data set.

- 2. Communication Parameters**

Users can enter a time interval in the **Communication Timeout** box, and a cycle in the **Update Cycle** box.

- 3. PLC I/O Mapping**

Users can set the bit devices and the registers which correspond to digital inputs, digital outputs, and analog registers on RTU-EN01. The bit devices set start from M2000. The registers used for the reading of data start from D2000, and the registers used for the writing of data start from D3000. The software automatically calculates end addresses according to the numbers set.

- 4. Setting the remote device mapping**

After users check an **Enable** cell, they have to enter the station address of RTU-EN01, an IP address, the number of digital inputs, the number of digital outputs, the number of registers used for the reading of data, and the number of registers used for the writing of data.

DVPEN01-SL can be mapped onto four slaves. The maximum number of digital inputs used for mapping, the maximum number of digital outputs used for mapping, the maximum number of registers used for mapping are described below.

Digital I/O (RX+RY): 256

Analog (Reading) register: 64

Analog (Writing) register: 64



## 5.9 IP Filter

An IP filter is used for restricting the connection of the network in case some uncertain IP addresses will cause errors. Only the IP addresses set within a certain range can establish a connection. Other IP addresses will be rejected.

### ■ Setting an IP filter

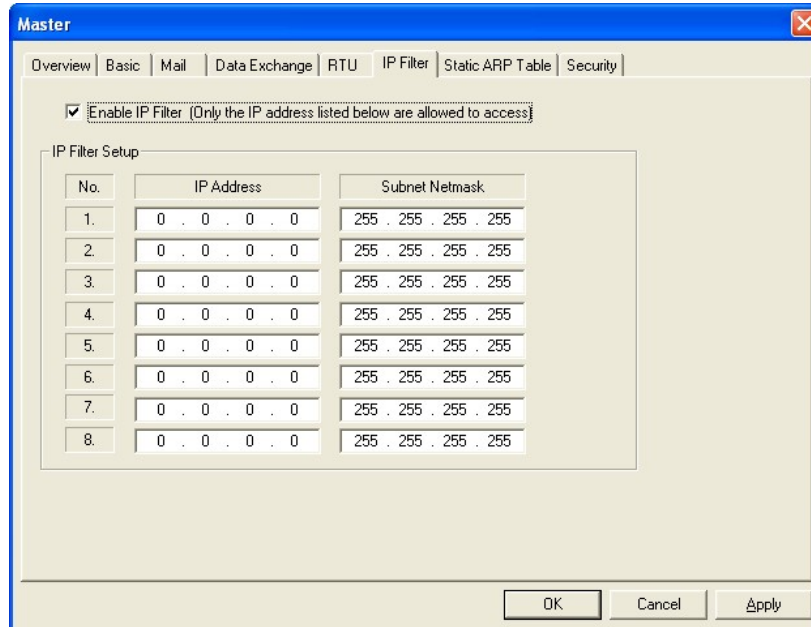

#### 1. Enable IP Filter

Check the box to enable IP filter.

#### 2. IP Address

IP addresses that are allowed to establish connections. Maximum 8 IP addresses are allowed.

#### 3. Subnet Netmask

The subnet of the IP address is allowed to establish a connection. To see whether the destination IP address is allowed, conduct bitwise AND operations between the allowed IP address and subnet mask and destination IP address and subnet mask. If the two values obtained are the same, the destination IP address is allowed by the IP filter. For example, assume the IP address is 192.168.0.1 and subnet mask 255.255.255.255, the only one IP address allowed to establish a connection is 192.168.0.1. If the subnet mask is 255.255.255.0, the IP addresses s allowed to establish connections will become 192.168.0.0~192.168.0.255.

## 5.10 Static ARP Table

ARP (Address Resolution Protocol) is used for obtaining the MAC address corresponding to the IP address in data transmission. For example, there is a datum to be sent to 172.16.155.250, but you do not know the corresponding MAC address. You can use ARP to look up the MAC address by IP address, and the corresponding MAC address will be saved, so you do not need to look it up again when sending the next datum. Therefore, if you do not know the MAC address, you will have to spend some time looking up the MAC address. If you want to enhance the transmission efficiency, use static ARP table to save time. For example, assume the IP address is 192.168.0.1 and MAC is 00:14:22:56:0F:7F. As long as there are data sent to 192.168.0.1, you will get the MAC address from the table.

## ■ Setting a static ARP table

No.	IP Address	MAC Address
1.	0 . 0 . 0 . 0	00:00:00:00:00:00
2.	0 . 0 . 0 . 0	00:00:00:00:00:00
3.	0 . 0 . 0 . 0	00:00:00:00:00:00
4.	0 . 0 . 0 . 0	00:00:00:00:00:00
5.	0 . 0 . 0 . 0	00:00:00:00:00:00
6.	0 . 0 . 0 . 0	00:00:00:00:00:00
7.	0 . 0 . 0 . 0	00:00:00:00:00:00
8.	0 . 0 . 0 . 0	00:00:00:00:00:00

### 1. IP Address

Destination IP address in data transmission.

### 2. MAC Address

The MAC addresses corresponding to the IP address.

#### Note:

Incorrect settings may result in connection failure. Therefore, DO NOT set the MAC address of the equipment without the network into the table.

## 5.11 Setting a Password

To prevent the set values in DVPEN01-SL from being modified, you can set a password to lock the settings in DVPEN01-SL.

### ■ Setting the DVPEN01-SL password

Login

Password

Password Setup

Modify

Password

Confirm Password

Load Factory Default

Factory Setting

### 1. Modify

Check the box to modify the password.

2. New password

Maximum 4 characters are allowed. Leave the column blank to disable the password protection function.

3. **Confirm Password**

Enter the new password again.

4. See section 6.4 for more details.

**Note:**

After the password is locked, all the pages cannot be set unless you unlock the password. However, if you set DVPEN01-SL by RS-232, you can return the setting to default setting whether the password is locked or not. For example, if you have locked DVPEN01-SL but forget the password, you have to return DVPEN01-SL to factory default setting by RS-232, and all the settings will return to default ones.

## 5.12 Returning to Default Settings

If you need to clear all the settings after many modifications on the settings and return the settings to default ones, select the **Factory Setting** checkbox.

■ **Returning to default settings**

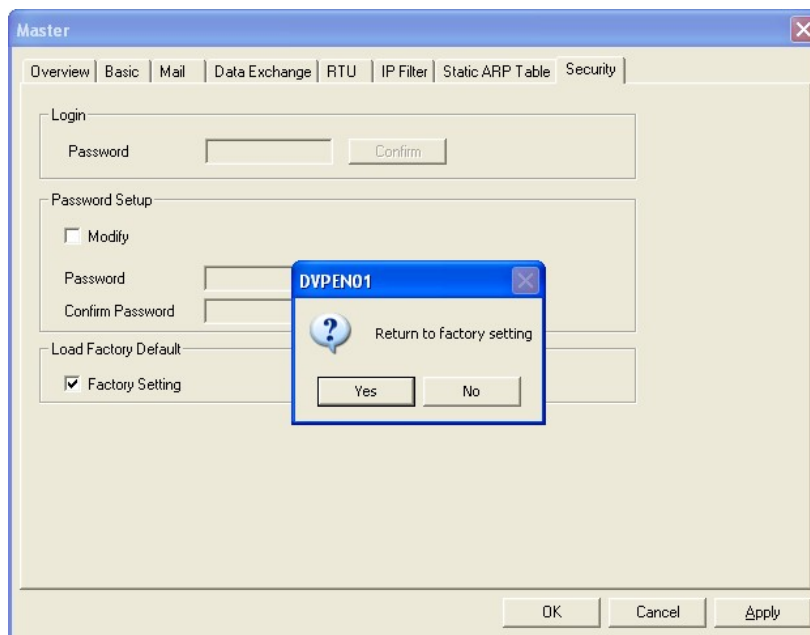

Select the **Factory Setting** checkbox, and click on **Yes**.

**Note:**

If you set DVPEN01-SL by RS-232, you can return the setting to default setting whether the password is locked or not. It takes approximately 10 seconds to return to default setting, so DO NOT switch off the power within the 10 seconds.

## 6 Application Examples

### 6.1 Setting an IP Address and Communication through WPLSoft

Application	Setting the network parameters of DVPEN01-SL directly on the PC.
Network environment	<p>(1) IP address of the PC executing WPLSoft: 192.168.0.3</p> <p>(2) Subnet mask: 255.255.255.0; Gateway: 192.168.0.1</p> <p>(3) IP address of DVPEN01-SL: 192.168.0.4</p> <p>(4) Connect the PC and DVPEN01-SL by RJ-45 cable.</p> <p><b>Note:</b> Both PC and DVPEN01-SL have to adopt a static IP address.</p>

1. The connection

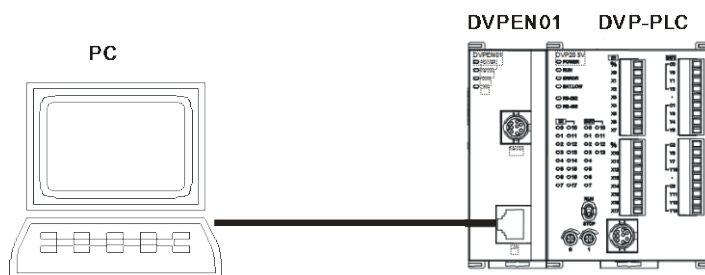

2. Start WPLSoft, and click **Ethernet** in the **Communication Setting** Section.

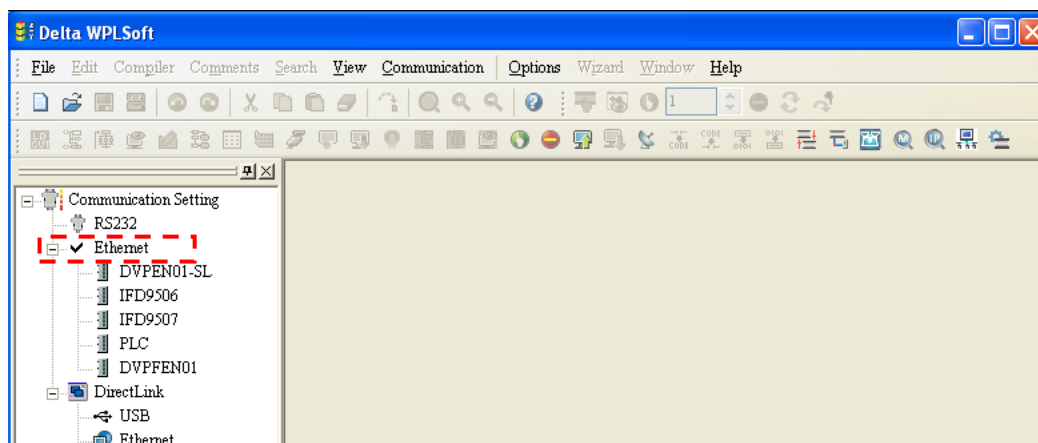

3. Click **Auto-Search Ethernet Module** to search for all the Ethernet modules on the network.

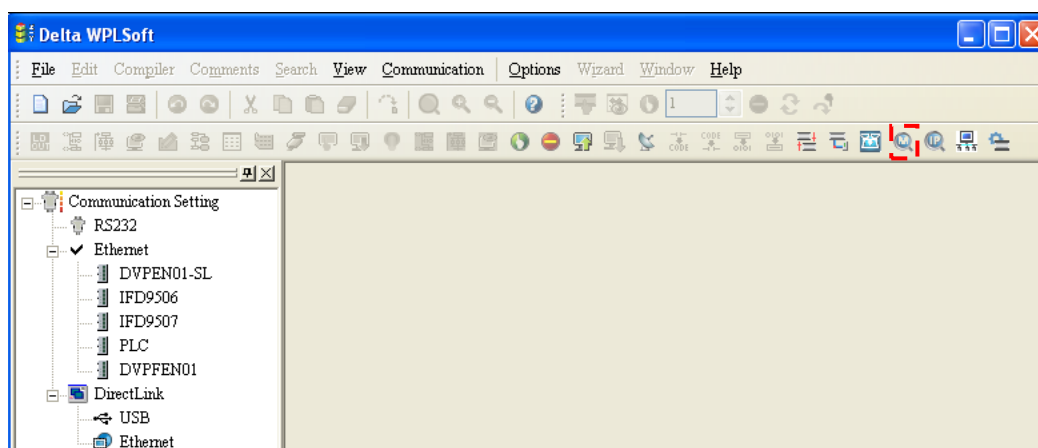

- All the devices connected to the network are shown in the **Ethernet** section. After **DELTA DVPEN01-SL** is clicked, WPLSoft can communicate with the MPU by means of DVPEN01-SL.

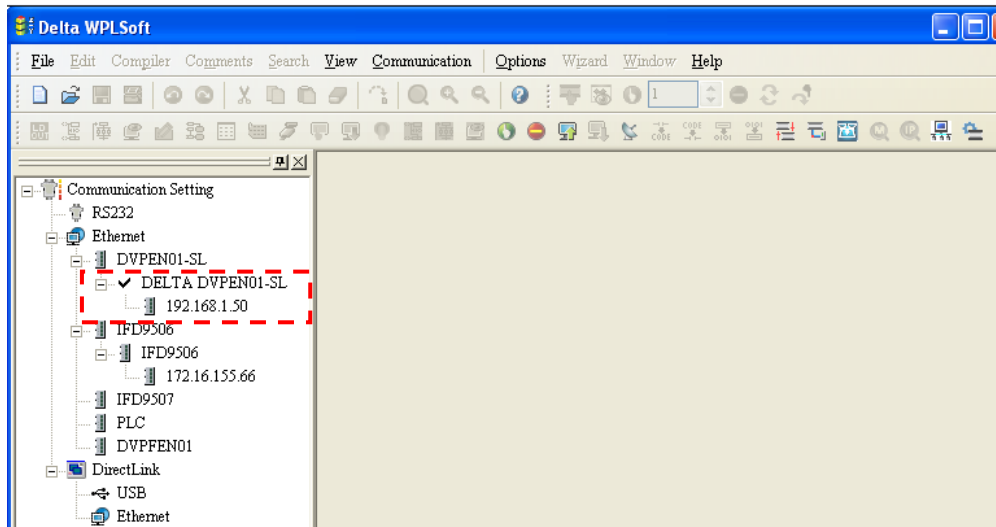

- After **DELTA DVPEN01-SL** in the **Ethernet** section is double-clicked, DCISoft will be started. Please refer to section 5.3 for more information about setting an IP address.

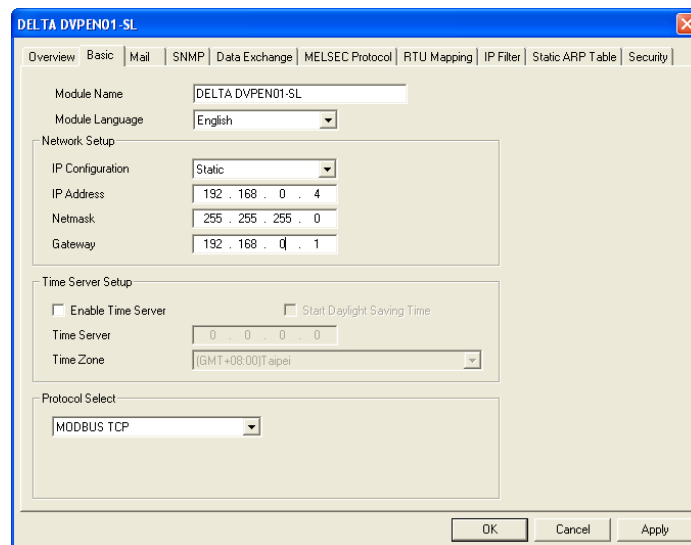

6. After the setting of an IP address is complete, and step 2~step 4 are repeated, the IP address can be used for communication.

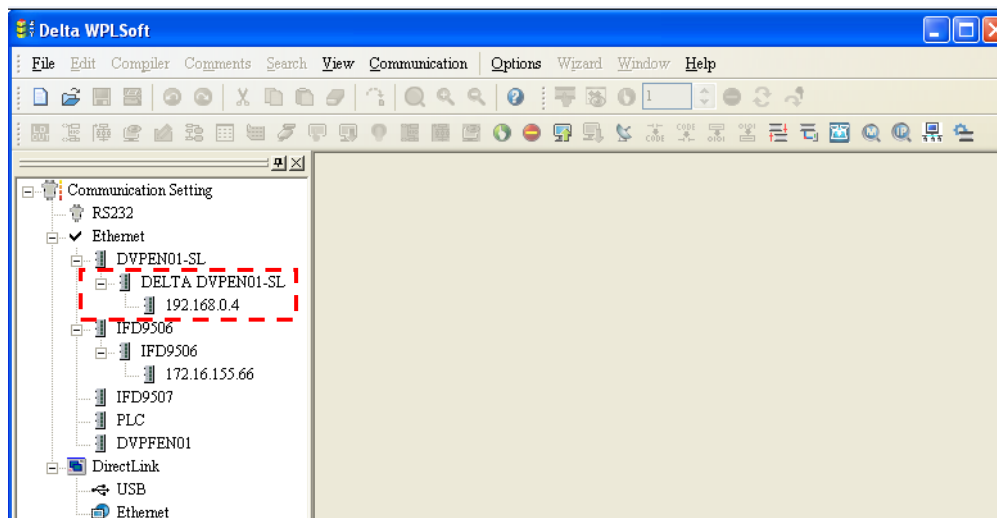

## 6.2 Connecting the PC with DVPEN01-SL through LAN

Application	Setting the network parameters of DVPEN01-SL by WPLSoft through LAN.
Network environment	<p>(1) Connect the PC and DVPEN01-SL by using DHCP server through LAN.</p> <p>(2) IP address of DVPEN01-SL: 172.16.157.148</p> <p><b>Note:</b> DVPEN01-SL can use a RJ-45 cable with/without a jump wire.</p>

1. The connection

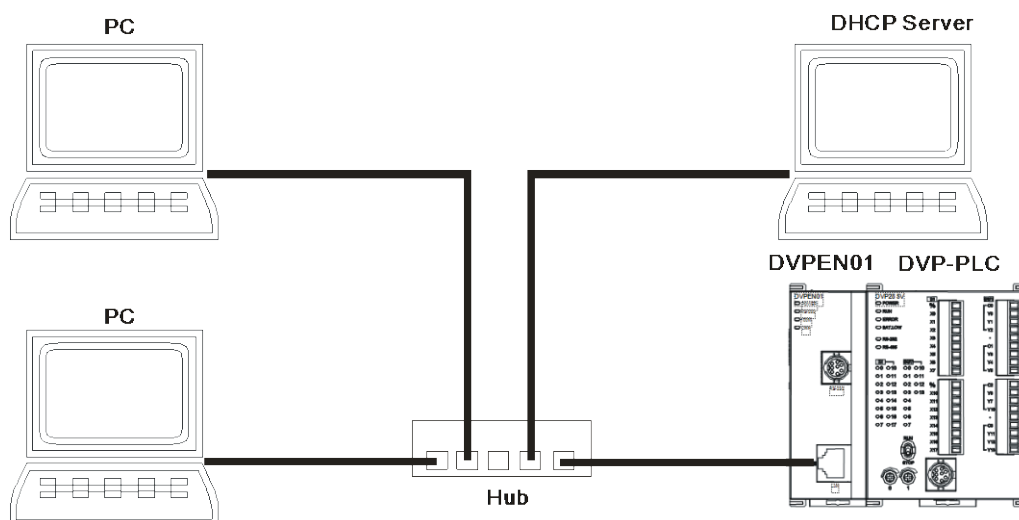

2. Start WPLSoft, and click **Ethernet** in the **Communication Setting** Section.

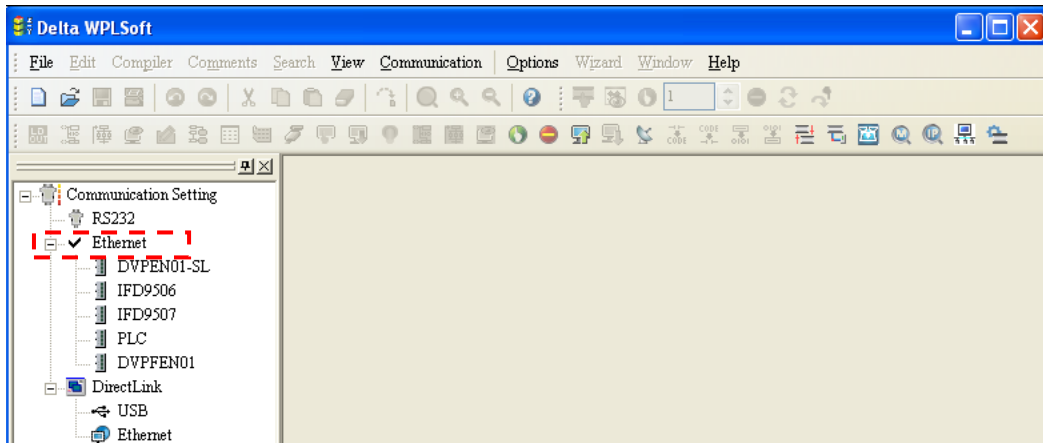

3. Click **Auto-Search Ethernet Module** to search for all the Ethernet modules on the network.

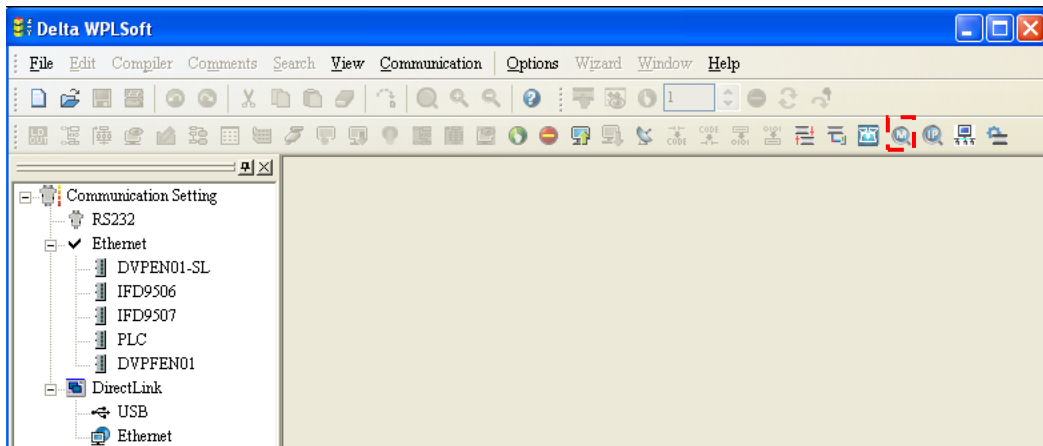

4. All the devices connected to the network are shown in the **Ethernet** section. After **DELTA DVPEN01-SL** is clicked, WPLSoft can communicate with the MPU by means of DVPEN01-SL.

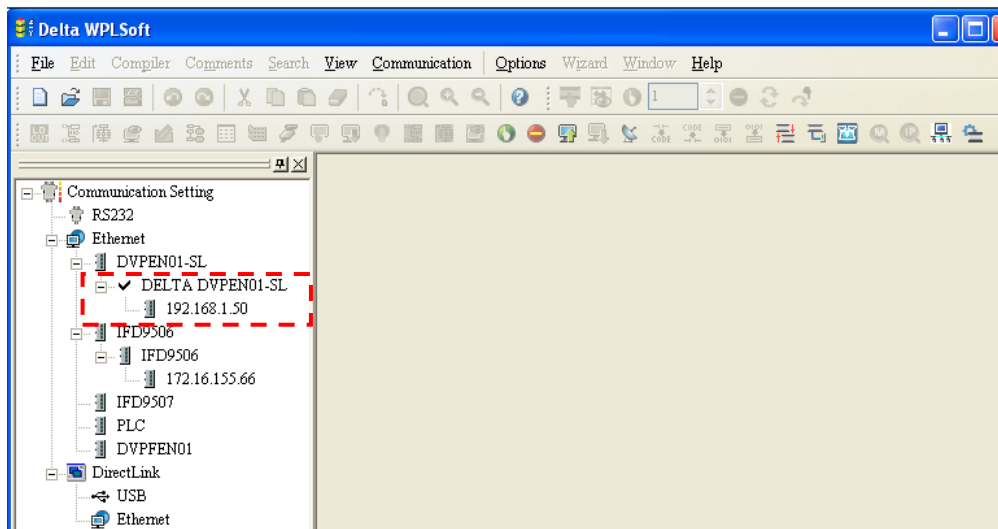

- After **DELTA DVPEN01-SL** in the **Ethernet** section is double-clicked, DCISoft will be started. Please refer to section 5.3 for more information about setting an IP address.

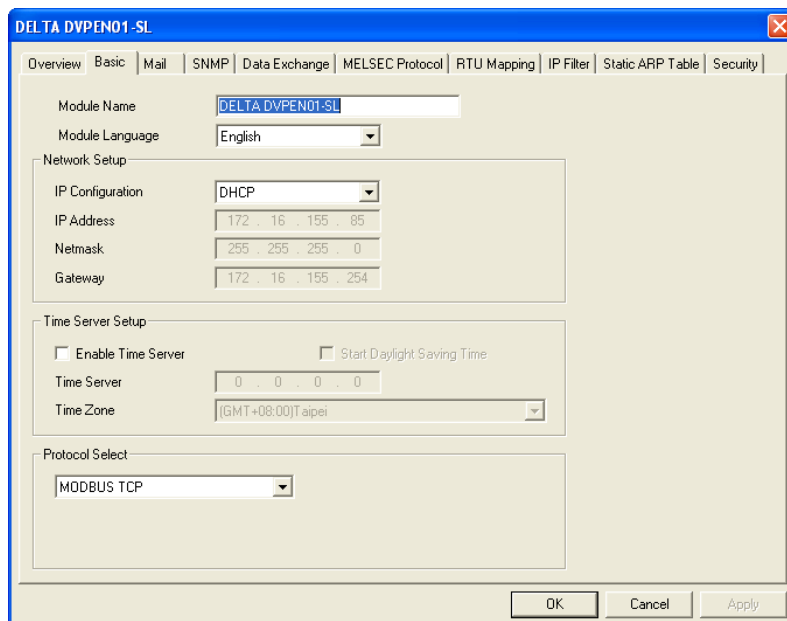

- After the setting of an IP address is complete, and step 2~step 4 are repeated, the IP address can be used for communication.

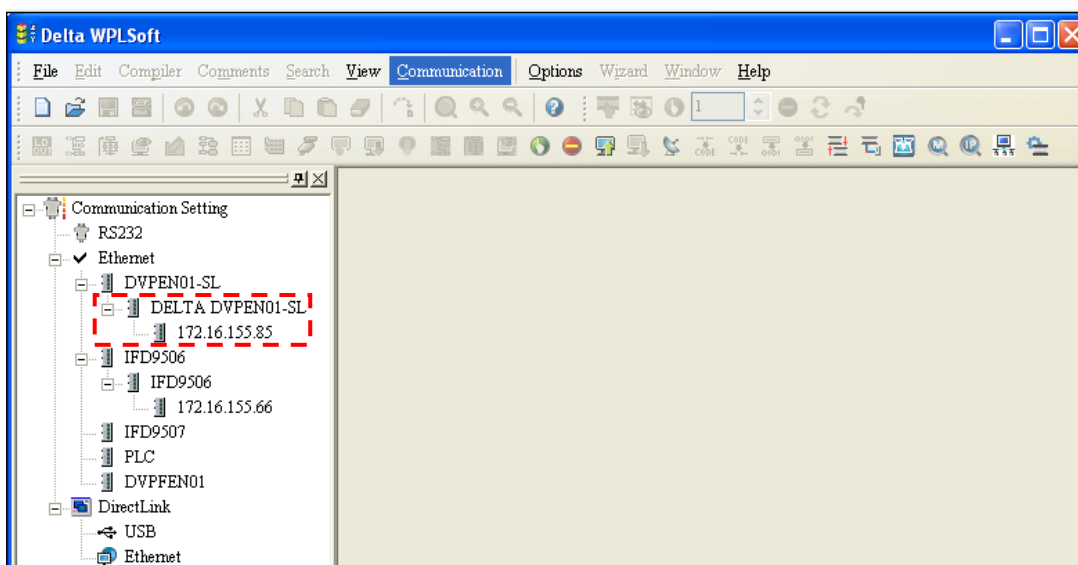

## 6.3 Setting a Password and Clearing a Password

Application	Setting and clearing a password by WPLSoft
Network environment	<ol style="list-style-type: none"> <li>Set password in DVPEN01-SL</li> <li>Unlock DVPEN01-SL</li> <li>Clear the password in DVPEN01-SL</li> </ol>

- See 6.1 for the connection and how to set the communication.
- Open the setup page and switch to the **Security** page.



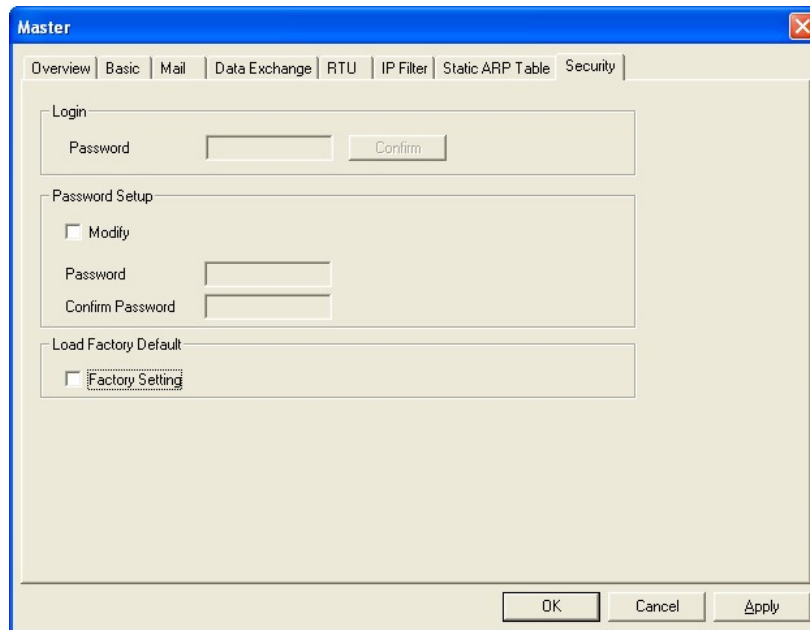

3. Select the **Modify** checkbox, and enter “aabb” in the **Password** box and the **Confirm Password** box. Click on **OK** to save the password.

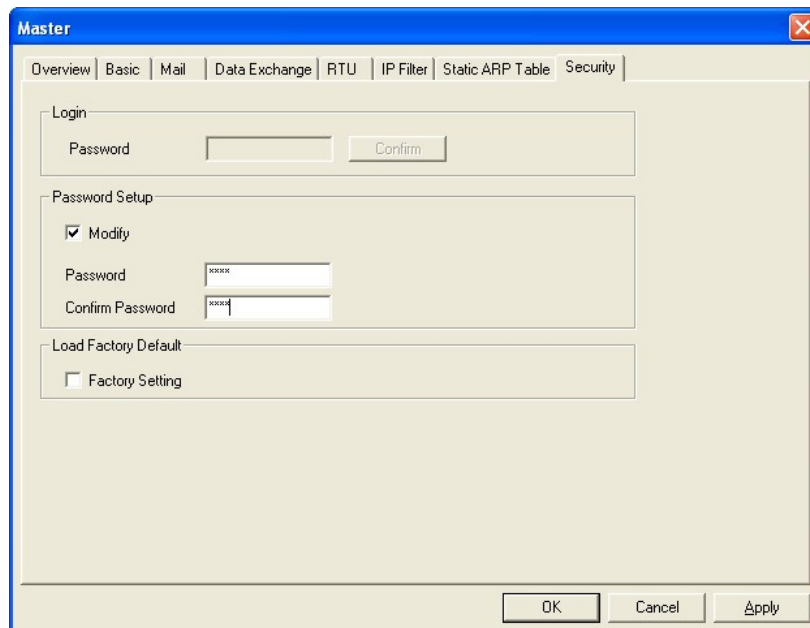

4. Open the setup page again, and DVPEN01-SL is now locked by the password. You cannot open any of the settings now. Click on **Confirm** to leave the entering password window.

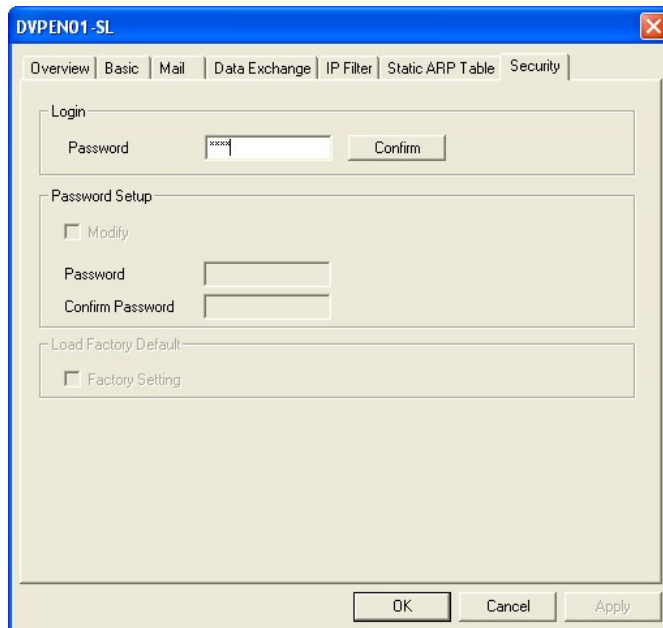

5. Enter the password to temporarily unlock the protection and modify the parameters. If you close the setup page, the locking will automatically be recovered.

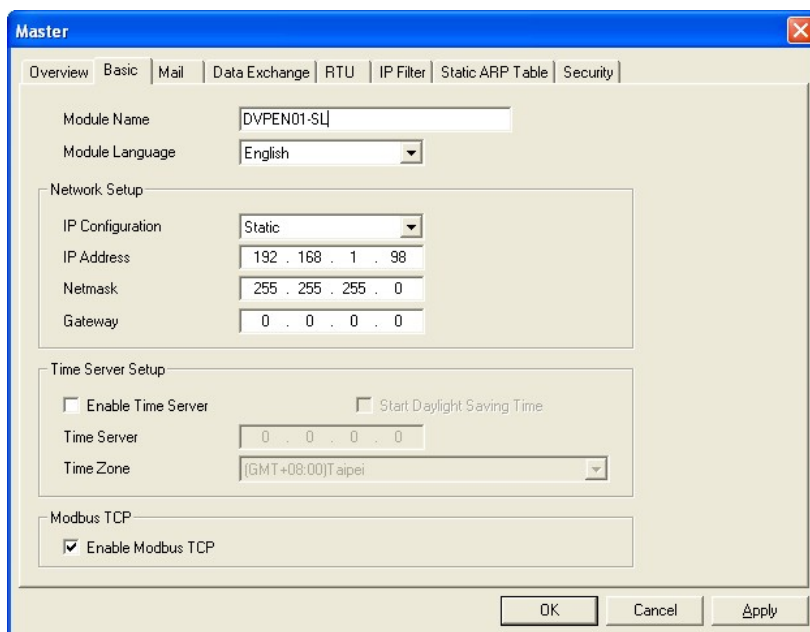

6. To clear the password, simply leave the password columns blank. Click on **Apply** to clear the password.

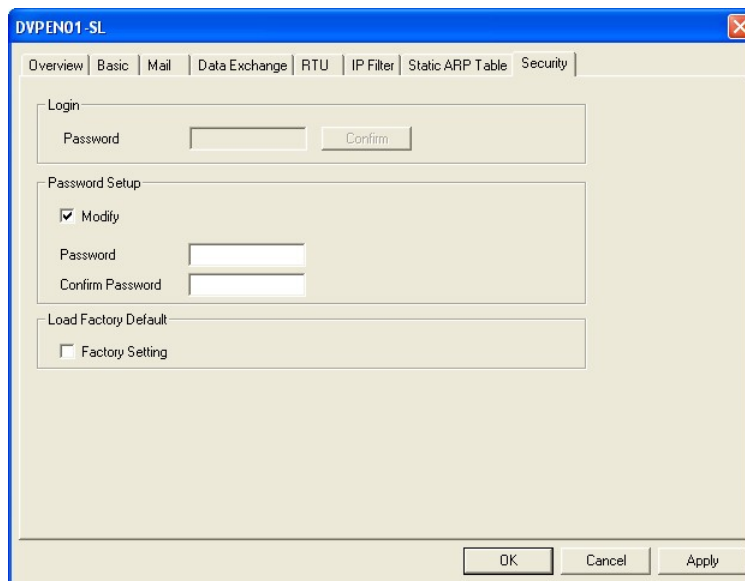

7. After the password is cleared, you can modify the parameters.

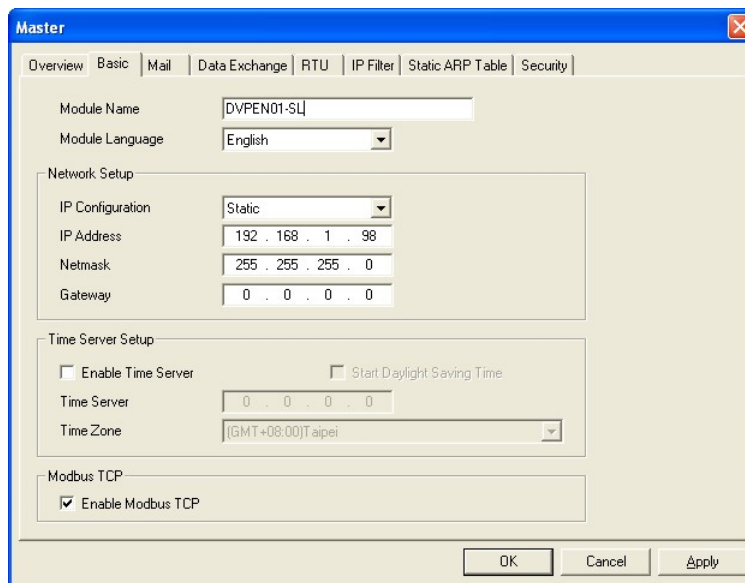

## 6.4 When the Password is Lost (Returning to Default Setting by RS-232)

Application	Returning to default setting by RS-232
Network environment	(1) DVPEN01-SL is set with a password. (2) The password is forgotten.

1. Use DVPACAB2A30 cable to connect the PC and DVPEN01-SL and open the setup page. Open the **Security** page.

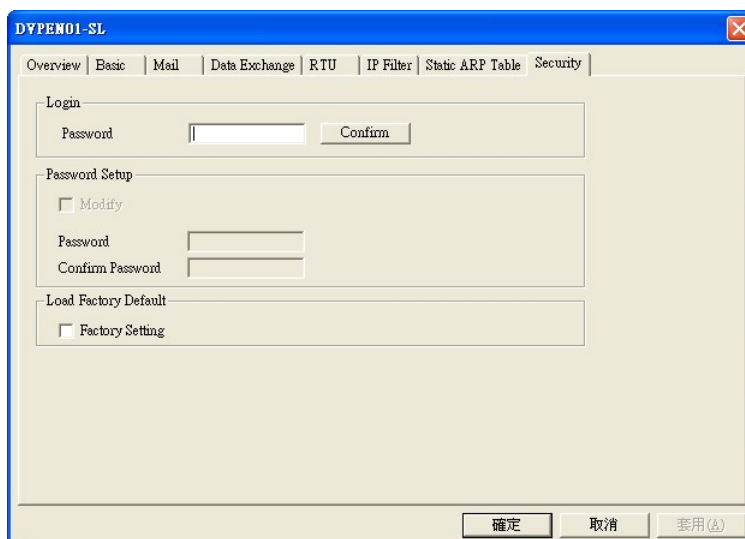

2. After the **Factory Setting** box is selected, a confirmation window will appear. Click on **Yes** to return to default settings (in approx. 5~10 seconds), and the password will be cleared as well.

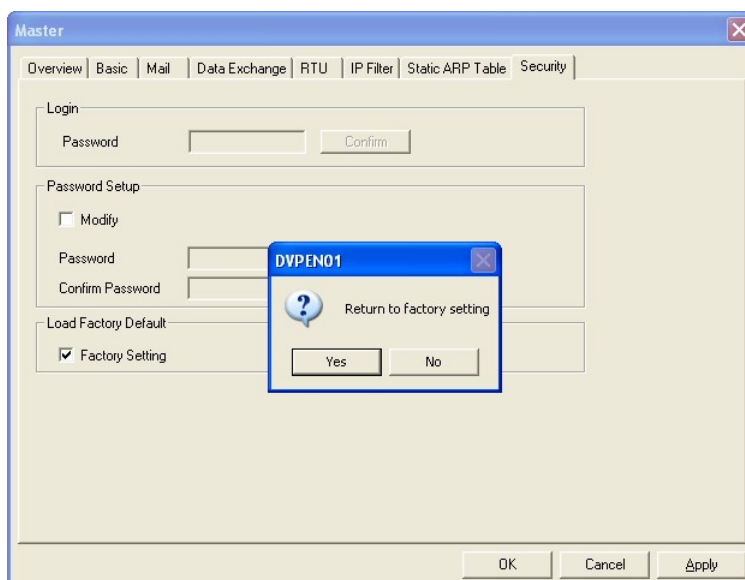

3. After the searching, all the parameters have already returned to their default settings.

## 6.5 IP Filter Protection

Application	Setting the IP filter protection
Network environment	(1) IP address of DVPEN01-SL: 192.168.0.4 (2) Only connections to 192.168.0.7 and 172.16.0.1~172.16.0.255 are allowed.

1. See 6.1 for the connection and how to set the communication.
2. Open the setup page and switch to the **IP Filter** page.

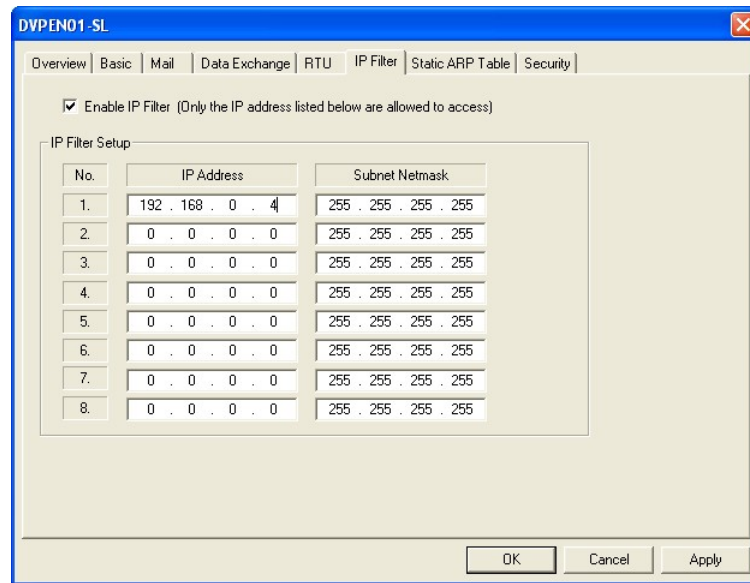

3. Select the **Enable IP Filter** checkbox. Enter “192.168.0.4” in the **No. 1 IP Address** box and “255.255.255.255” in the **No. 1 Subnet Netmask** box.

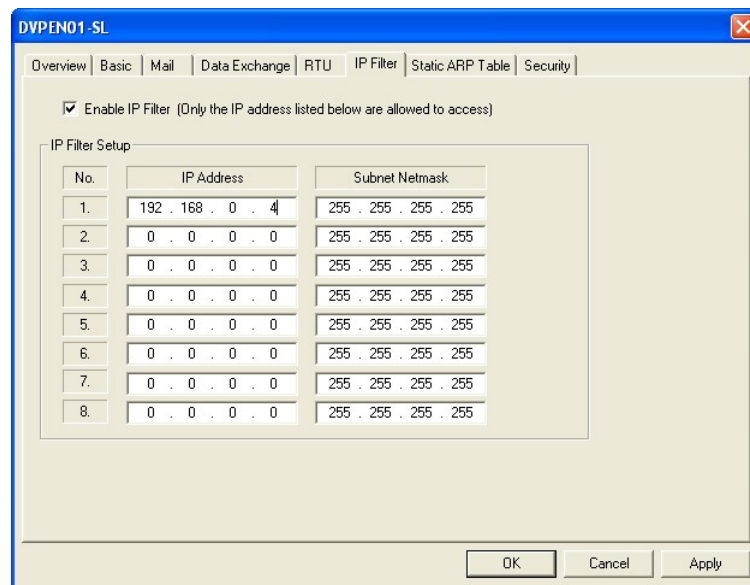

4. Enter “192.168.0.1” in the **No. 2 IP Address** box and “255.255.255.0” in the **No.2 Subnet Netmask** box. Click on **OK** to complete the setting. Only the equipment within the IP address range can be connected.

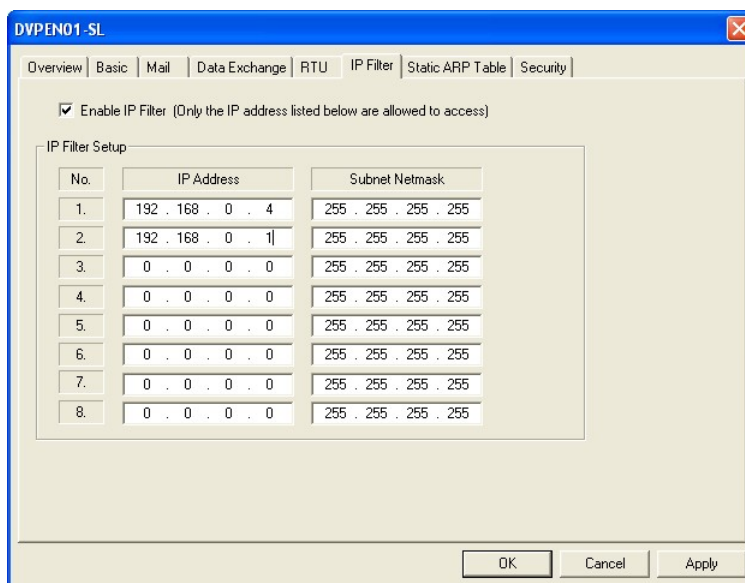

## 6.6 Setting a Static ARP Table

Application	Setting a static ARP table
Network environment	(1) MAC address of equipment 192.168.1.6 is 00:18:23:10:00:35 (2) MAC address of equipment 192.168.1.1 is 00:18:23:10:00:04

1. See 6.1 for the connection and how to set the communication.
2. Open the setup page and switch to the **Static ARP Table** page.

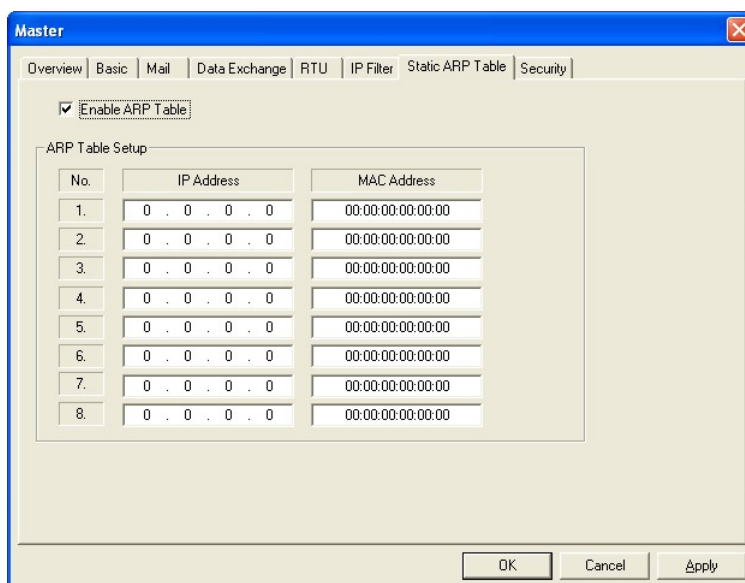

3. Select the **Enable ARP Table** checkbox. Enter "192.168.1.6" in the **No. 1 IP Address** box, and its corresponding MAC address is "00:18:23:10:00:35".

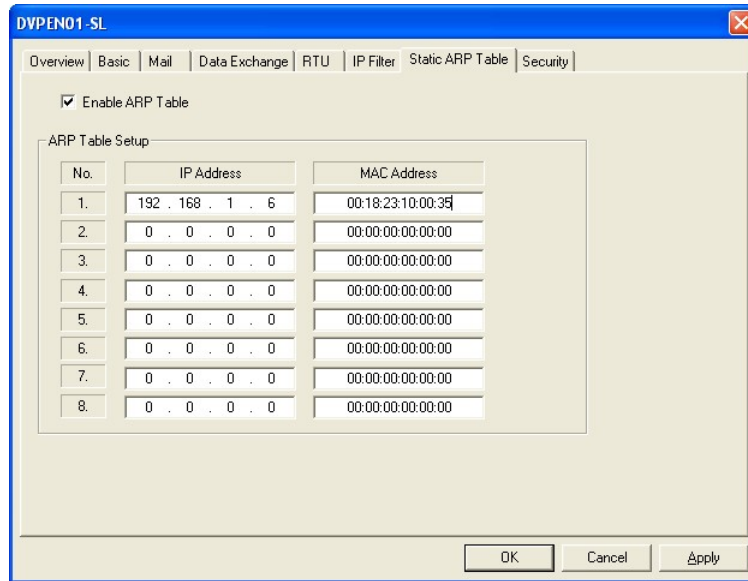

4. Enter “192.168.1.1” in **No.2 IP Address** box, and its MAC address is “00:18:23:10:00:04”. Click on **OK** to complete the setting. Only the equipment within the IP address range can be connected.

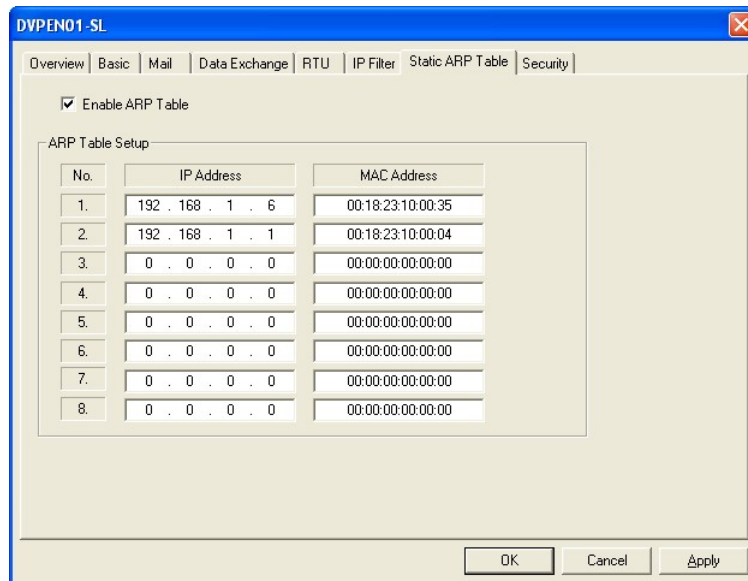

**Note:**

The MAC address of DVPEN01-SL can be obtained from WPLSoft or the MAC address sticker on the equipment. The MAC address of PC can be found in the **Network Connection Details** widow (see below).



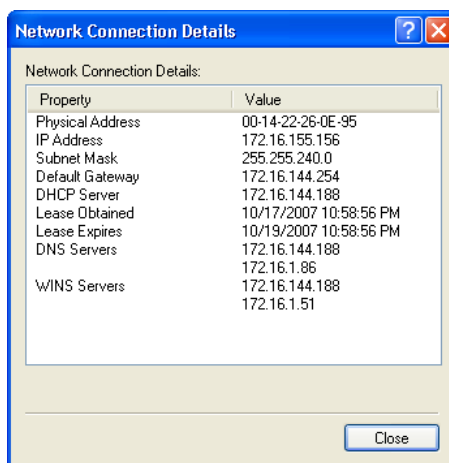

## 6.7 Application of E-mails

Application	Sending an E-mail to notify the administrator when the current status of X0 and Y0 is changed.
Network application	(1) IP address of the SMTP server: 172.16.144.121 (2) E-mail address of administrator: test@sample.com (3) An E-mail message will be generated when the status of X0 and Y0 is changed.

1. See 6.1 for the connection and how to set the communication.
2. Open the setup page and switch to the **Mail** page.

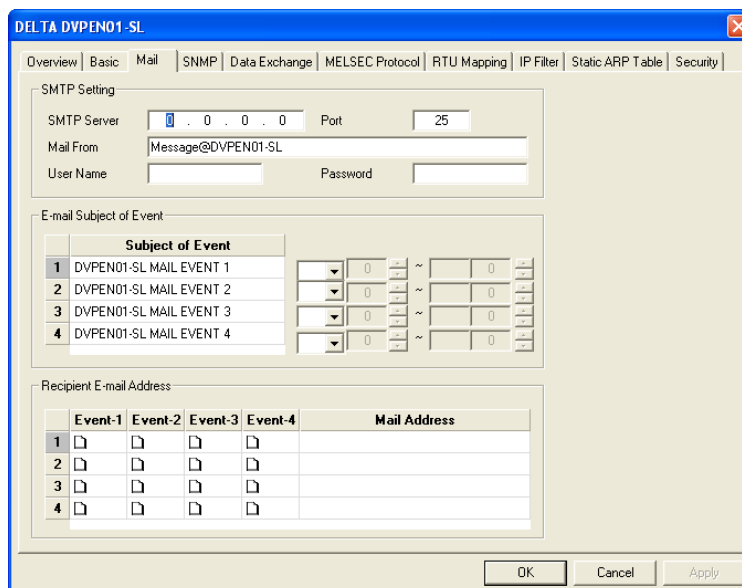

3. Set E-mails and select events. Enter the address of the SMTP server, the subjects of the E-mails, a user name/password, the E-mail addresses of the recipients, the present values in the registers (D devices, T devices, and C devices) attached to the E-mails, and the number of values. Check the **Event** cells for receipt 1. Click **Apply** to complete the setting of E-mails.



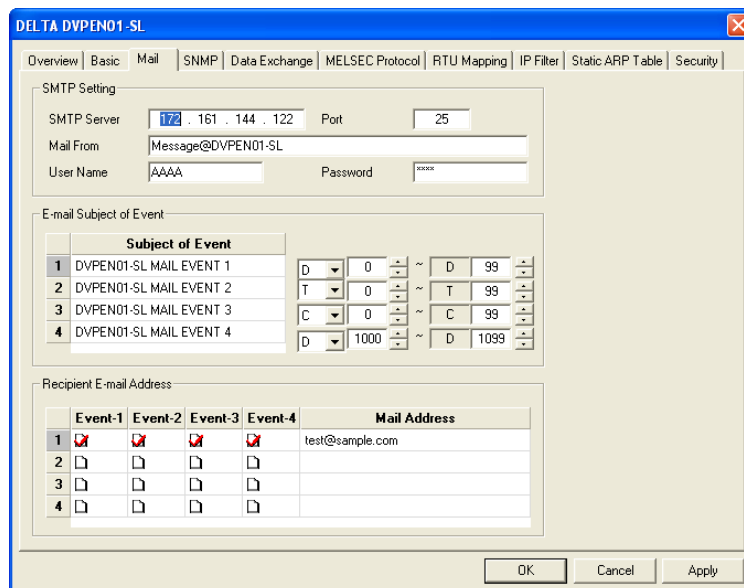

4. After all the settings in DVPEN01-SL are completed, compile the ladder diagram in the MPU and download it to the MPU. See below for the program design:

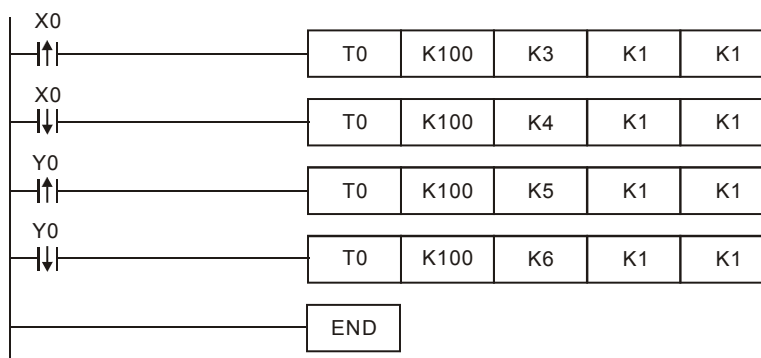

Explanations:

- If the rising-edge of X0 is triggered, X0 will go from Off to On. Write “1” into CR#3 of DVPEN01-SL, and the first E-mail will be sent out.
- If the falling-edge of X0 is triggered, X0 will go from On to Off. Write “1” into CR#4 of DVPEN01-SL, and the second E-mail will be sent out.
- If the rising-edge of Y0 is triggered, Y0 will go from Off to On. Write “1” into CR#5 of DVPEN01-SL, and the third E-mail will be sent out.
- If the falling-edge of Y0 is triggered, Y0 will go from On to Off. Write “1” into CR#6 of DVPEN01-SL, and the fourth E-mail will be sent out.
- 

## 6.8 Application of Data Exchange (1)

Application	Writing the time in RTC in PLC_B into D0~D6 of PLC_A
Network environment	(1) Adopt a static IP address. (2) IP address of PLC_A: 192.168.0.4 (3) IP address of PLC_B: 192.168.0.5 (4) Update from PLC_B to PLC_A.

1. See 6.1 for how to set the communication.

- Open the setup page of PLC\_B and switch to the **Data Exchange** page.

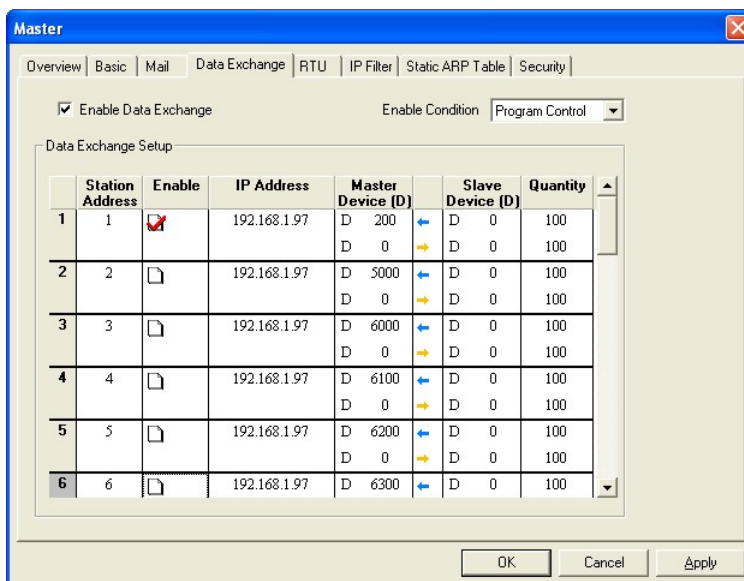

- Select the **Enable Data Exchange** checkbox. Select Program Control in the **Enable Condition** drop-down list box. Enter the IP address of PLC\_A "192.168.0.4" in the **IP Address** cell corresponding to station address 1. Click on **Apply** to complete the setting.

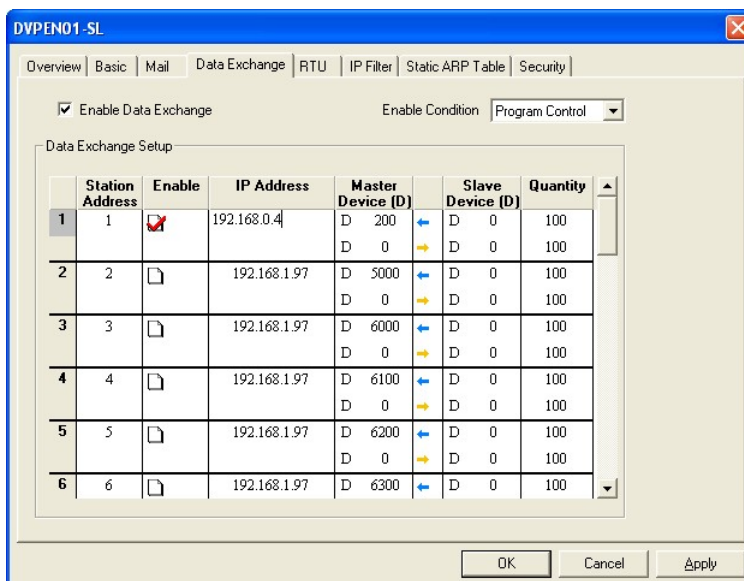

- After all the settings in PLC\_B are completed, compile the ladder diagram in the MPU and download it to PLC\_B. The program designed is like the one shown below.

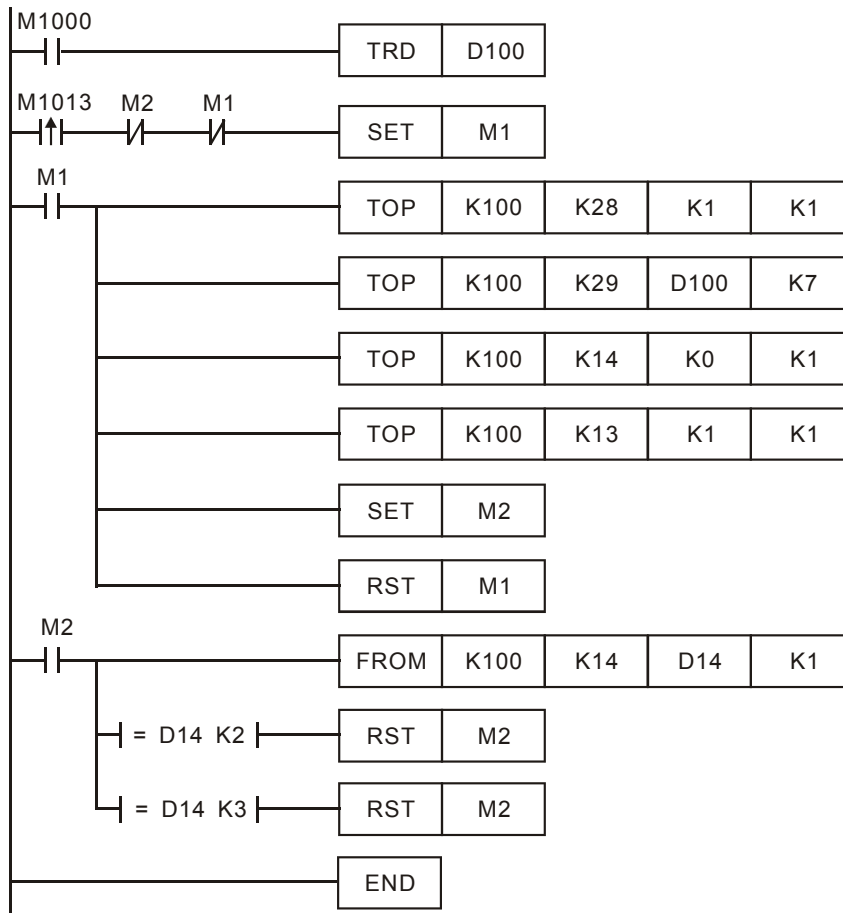

Explanations:

- The data exchange will be executed every one second.
  - Write the communication address of the destination PLC in CR#28, and DVPEN01-SL will automatically detect by the previous setting that No. 1 IP address is "192.168.0.4".
  - Write the data in RTC into CR#29~CR#35.
  - Write "1" into CR#13 to start the data exchange.
  - CR#14=2 refers to successful exchange. CR#14=3 refers to failed exchange.
5. Compile the ladder diagram for PLC\_A and download it to PLC\_A.

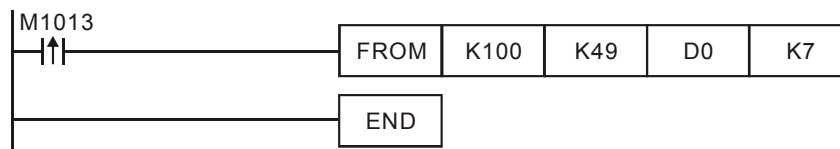

Explanations:

- The received data are stored in CR#49~CR#55.
- The data received every one second are written into D0~D6.

## 6.9 Application of Data Exchange (2)

Firmware version 2.0 and above support this function.

Application	Select <b>Always Enable</b> in the <b>Enable Condition</b> drop-down list box. Enable a timer and write the timer values into D0~D99. Continuously write the present values in D0~D99 of PLC_A into D0~D99 of PLC_B, and write the values in D0~D99 of PLC-B into D200~D299 of PLC_A.
-------------	---

Network environment	<ol style="list-style-type: none"> <li>(1) Adopt a static IP address.</li> <li>(2) IP address of PLC_A: 192.168.1.99</li> <li>(3) IP address of PLC_B: 192.168.1.97</li> <li>(4) Update from PLC_A to PLC_B and PLC_B to PLC_A.</li> </ol>
---------------------	--

1. See 6.1 for how to set the communication.
2. Open the setup page of PLC\_A and switch to the **Data Exchange** page.

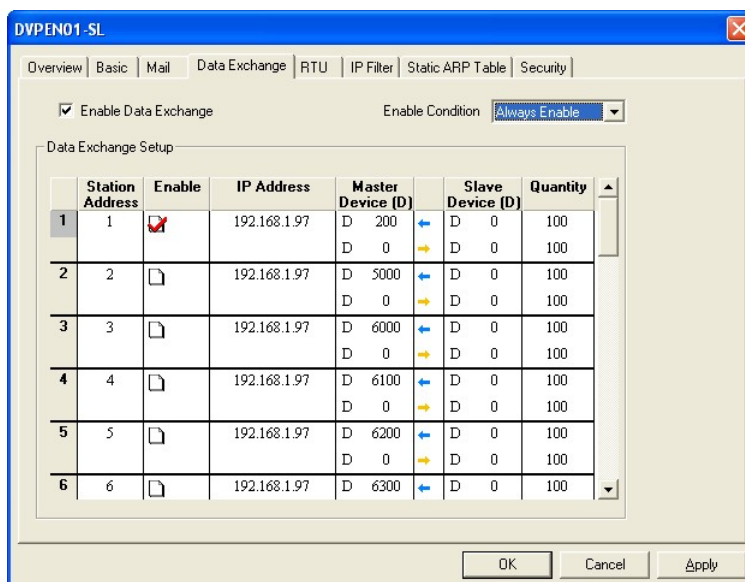

3. Select the **Enable Data Exchange** checkbox. Select **Always Enable** in the **Enable Condition** drop-down list box. Check the **Enable** cell corresponding to station address 1. Enter the IP address of PLC\_B “192.168.1.97” in the **IP Address** cell corresponding to station address 1, select D200 and D0 in the **Master Device** cell corresponding to station address 1, select D0 and D0 in the **Slave Device** cell corresponding to station address 1, and select 100 and 100 in the **Quantity** cell corresponding to station address 1.

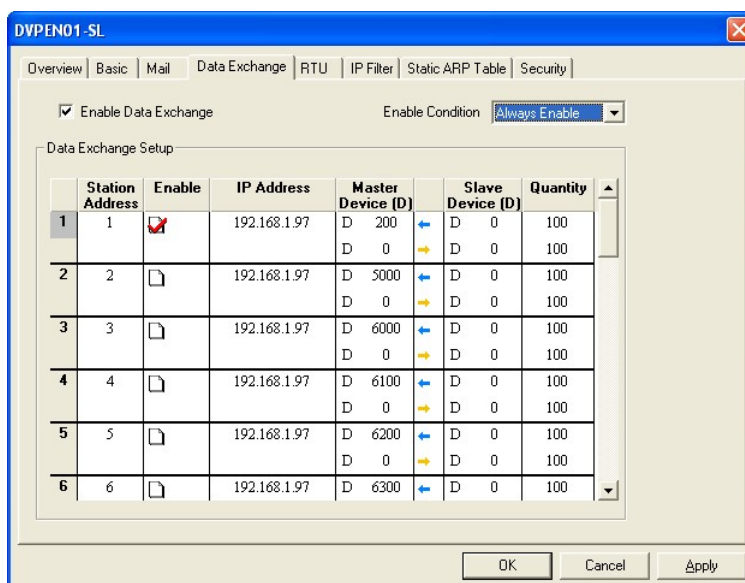

4. After all the settings in PLC\_A are completed, you have to write a ladder diagram for the MPU and download it to PLC\_B. The program designed is like the one shown below.

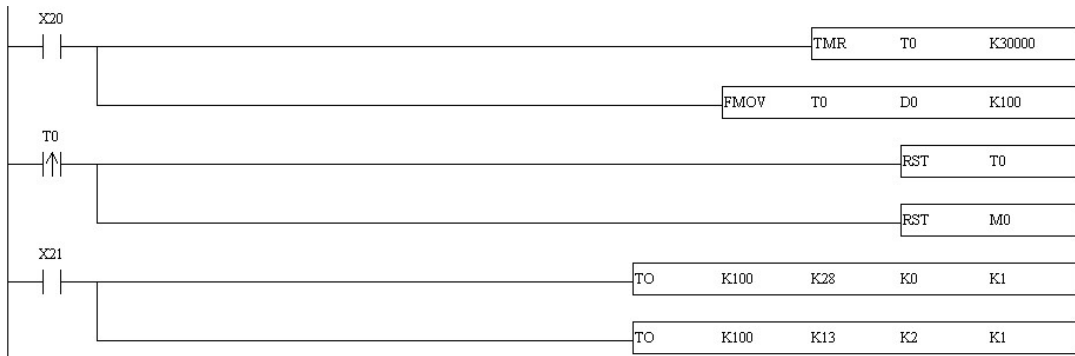

## 6.10 Application of Data Exchange (3)

Firmware version 2.0 and above support this function.

Application	Enable a timer (X20) and write the timer values into D0~D99. Control the program (X21) and write the present values in D0~D99 of PLC_A into D0~D99 of PLC_B, and write the values in D0~D99 of PLC-B into D200~D299 of PLC_A. Control the program (X21) to stop the execution.
Network environment	(1) Adopt a static IP address. (2) IP address of PLC_A: 192.168.1.99 (3) IP address of PLC_B: 192.168.1.97 (4) Update from PLC_A to PLC_B and PLC_B to PLC_A.

- See 6.1 for how to set the communication.
- Open the setup page of PLC\_A and switch to the **Data Exchange** page.

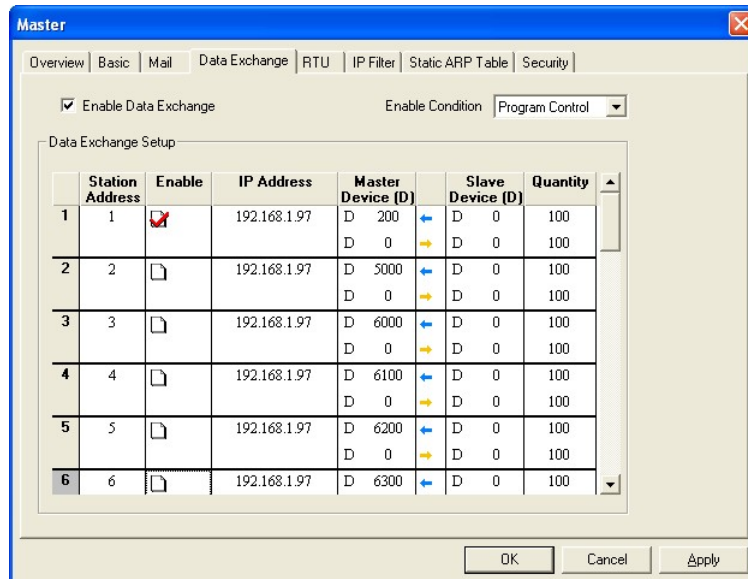

- Select the **Enable Data Exchange** checkbox. Select **Program Control** in the **Enable Condition** drop-down list box. Check the **Enable** cell corresponding to station address 1. Enter the IP address of PLC\_B "192.168.1.97" in the **IP Address** cell corresponding to station address 1, select D200 and D0 in the **Master Device** cell corresponding to station address 1, select D0 and D0 in the **Slave Device** cell corresponding to station address 1, and select 100 and 100 in the **Quantity** cell corresponding to station address 1.

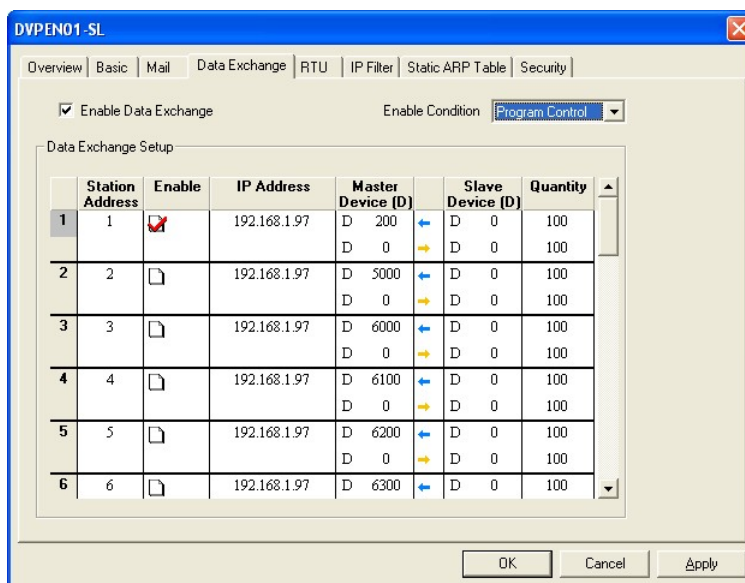

4. After all the settings in PLC\_A are completed, you have to write a ladder diagram for the MPU and download it to PLC\_B. The program designed is like the one shown below.



## 6.11 Application of Data Exchange (4)

Application	Writing the time of the RTC in PLC_B into D0~D6 of PLC_A by, and using a ladder diagram to designate an IP address
Network environment	(1) Adopt a static IP address. (2) IP address of PLC_A: 192.168.0.4 (3) IP address of PLC_B: 192.168.0.5 (4) Update from PLC_B to PLC_A

1. See 6.1 for how to set the communication. Compile the ladder diagram in the MPU and download it to PLC\_B. The program designed is like the one shown below.

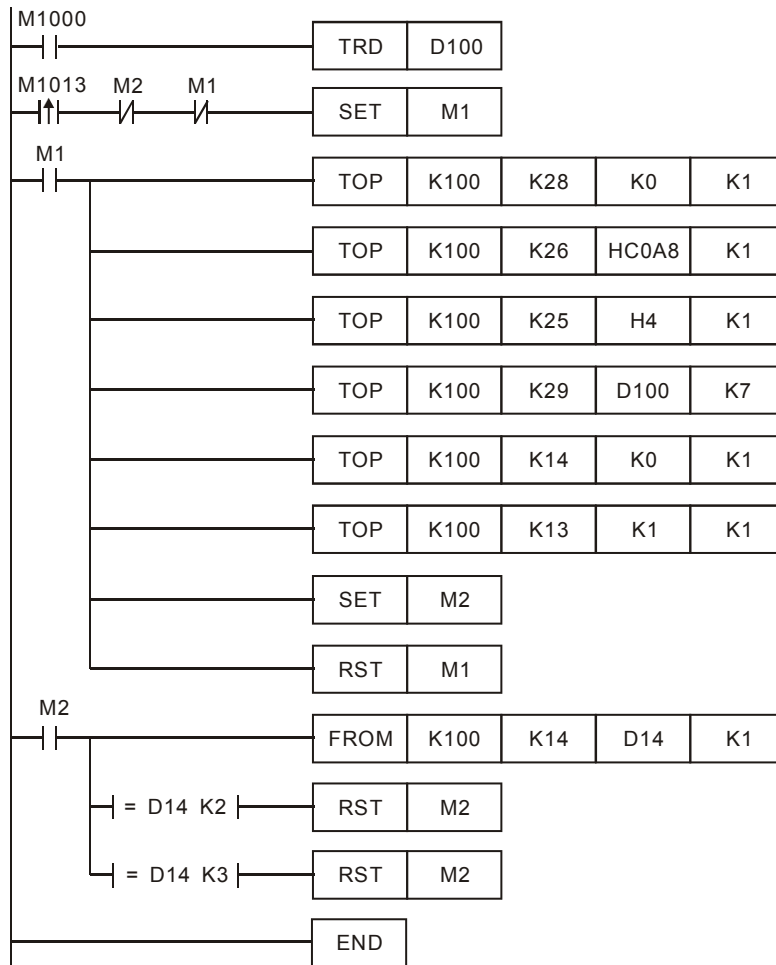

Explanations:

- The data exchange will be executed every one second.
- Write “0” into CR#28, and PLC\_B will use CR#25~CR#26 as the IP address of the destination PLC.
- Write the IP address of PLC\_A into CR#25 and CR#26. The first two IP codes (192.168=H'C0A8) should be written into CR#26, and the last two IP codes (0.4=H'0004) into CR#25.
- Write the data in RTC into CR#29~CR#35.
- Write “1” into CR#13 to start the data exchange.
- CR#14=2 refers to successful execution. CR#14=3 refers to failed execution.

2. Compile the ladder diagram for PLC\_A and download it to PLC\_A.

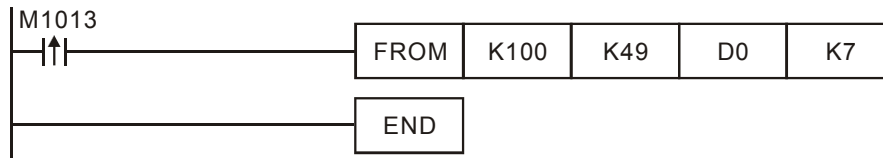

Explanations:

- The received data are stored in CR#49~CR#55.
- The data received every one second are written into D0~D6.

## 6.12 Application of Data Exchange (5)

Application	Writing the time in RTC in PLC_B directly into D0~D6 of PLC_A without writing in ladder diagram into PLC_A.
Network environment	(1) Adopt a static IP address. (2) IP address of PLC_A: 192.168.0.4 (3) IP address of PLC_B: 192.168.0.5 (4) Update from PLC_B to PLC_A.

1. See 6.1 for how to set communication.
2. Compile the ladder diagram in the MPU and download it to PLC\_B. We do not need to write any corresponding ladder diagram into PLC\_A.

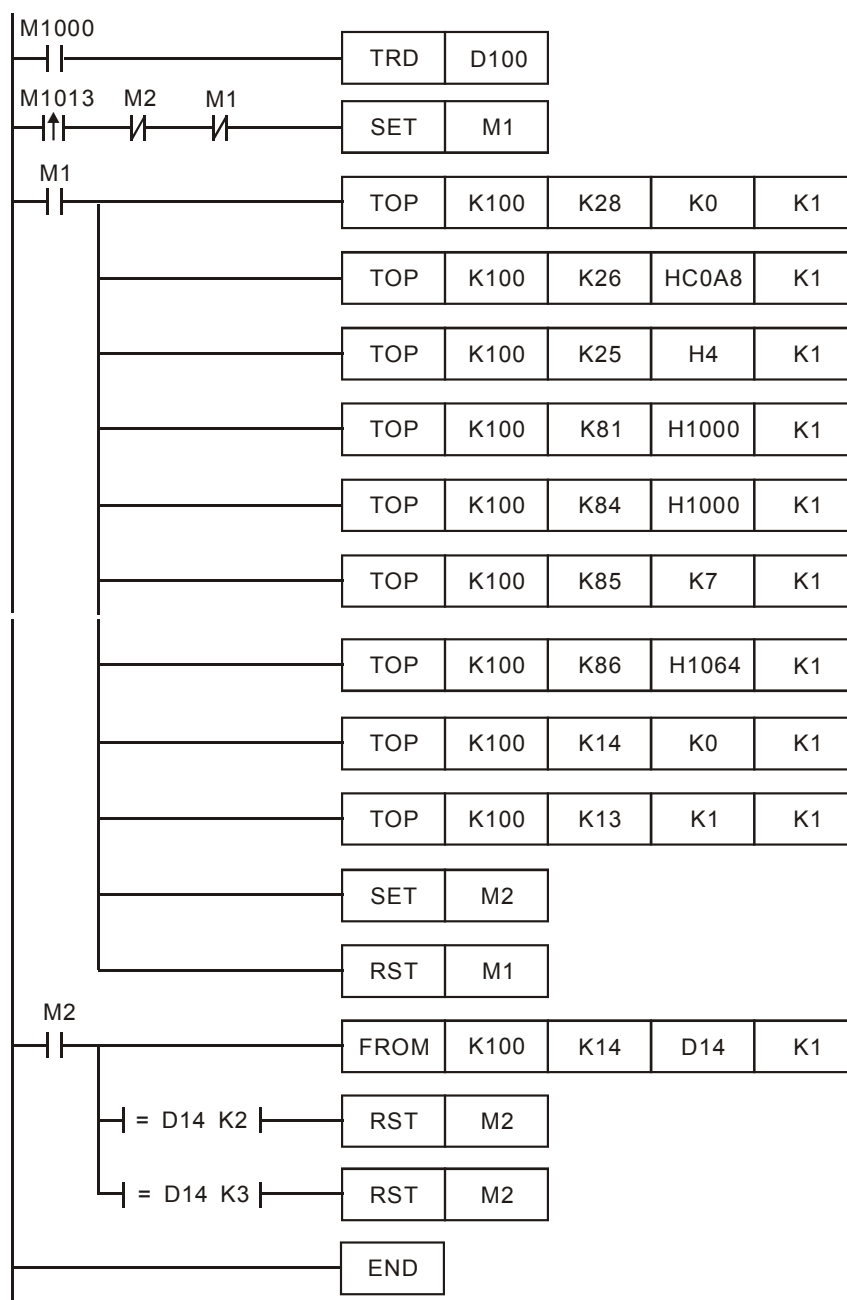

Explanations:

- The data exchange will be executed every one second.
- Write "0" into CR#28, and PLC\_B will use CR#25~CR#26 as the IP address of the destination PLC.



- Write the IP address of PLC\_A into CR#25 and CR#26. The first two IP codes (192.168=H'C0A8) should be written into CR#26, and the last two IP codes (0.4=H'0004) into CR#25.
- Write the MODBUS address of D0 (H'1000) in PLC\_A into CR#81 and CR#84.
- Write the MODBUS address of D100 (register of RTC) (H'1064) into CR#86.
- Write the number of registers K7 into CR#85.
- Write "1" into CR#13 to start the data exchange.
- CR#14=2 refers to successful execution. CR#14=3 refers to failed execution.
- Once the data exchange is successful, the values in D1313~D1318 in PLC\_B will be written into D0~D6 of PLC\_A.

### 6.13 Application of MODBUS TCP Master

Application	Compiling MODBUS instruction by PLC_B, making Y0 of PLC_A flashing
Network environment	(1) Adopt a static IP address. (2) IP address of PLC_A: 192.168.0.4 (3) IP address of PLC_B: 192.168.0.5 (4) Update from PLC_B to PLC_A (5) Use MODBUS instruction 050500FF00 to set "On" Y0. (6) Use MODBUS instruction 0505000000 to set "Off" Y0. (7) Y0 goes between On/Off once every one second.

1. See 6.1 for how to set the communication.
2. Compile the ladder diagram in the MPU and download it to PLC\_B. See below for the program design. We do not need to write any corresponding ladder diagram into PLC\_A.

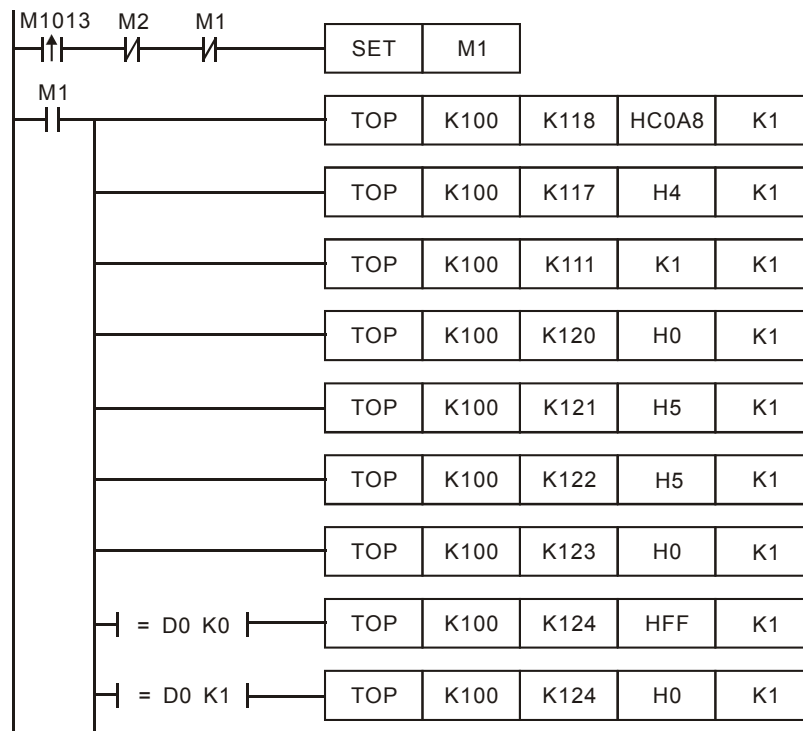

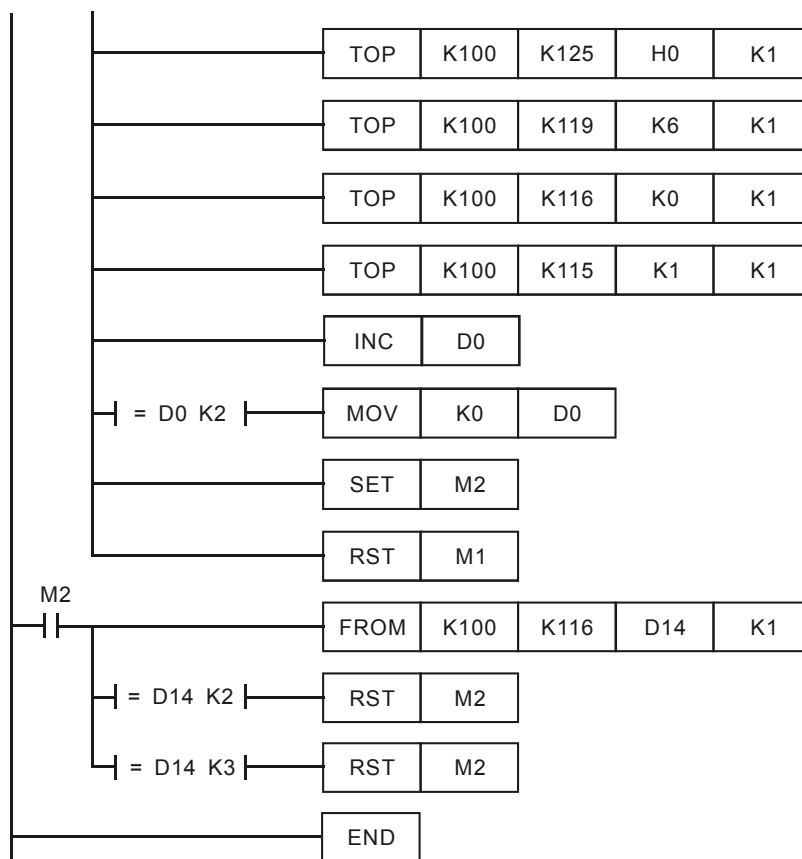

## Explanations:

- The data exchange will be executed every one second.
- Write the IP address of PLC\_A into CR#117 and CR#118. The first two IP codes (192.168=H'C0A8) should be written into CR#118, and the last two IP codes (0.4=H'0004) into CR#117.
- Set CR#111 as "1" to enable the 8-bit mode. The MODBUS instruction is stored in the low byte of CR#120~CR#247.
- Write MODBUS instruction into CR#120~CR#125. CR#120 is the MODBUS address.
- Write the length of the instruction into CR#119.
- Write "1" into CR#115 to start the execution of MODBUS TCP instruction.
- CR#116=2 refers to successful execution. CR#116=3 refers to failed execution.
- If the execution is successful, Y0 on PLC\_A will go between On and Off every one second.

## 6.14 RTU Mapping

Application	Using RTU mapping to read/write the remote digital I/O and analog I/O registers. DVP28SV+DVPEN01-SL→RTU-EN01+DVP06XA+DVP16SP
Network environment	<ol style="list-style-type: none"> <li>(1) Adopt a static IP address.</li> <li>(2) IP address of DVPEN01-SL: 192.168.1.90</li> <li>(3) IP address of RTU-EN01: 92.168.1.91</li> <li>(4) Use DCISoft for RTU-EN01 and check 10 mapping data for read and 10 mapping data for write.</li> <li>(5) Set the mapping start address and number of data for RX, RY, RCR (read) and RCR (write) at DVPEN01-SL.</li> <li>(6) Enable the mapping function in DVP-SV PLC at DVPEN01-SL. Use M2000 and D2000 in DVP-SV to read and M3000 and D3000 to write the value in the remote RTU-EN01.</li> </ol>

1. Please refer to section 6.1 for more information about setting communication.
2. Use DCISoft for RTU-EN01 to set mapping control registers used for reading/writing.

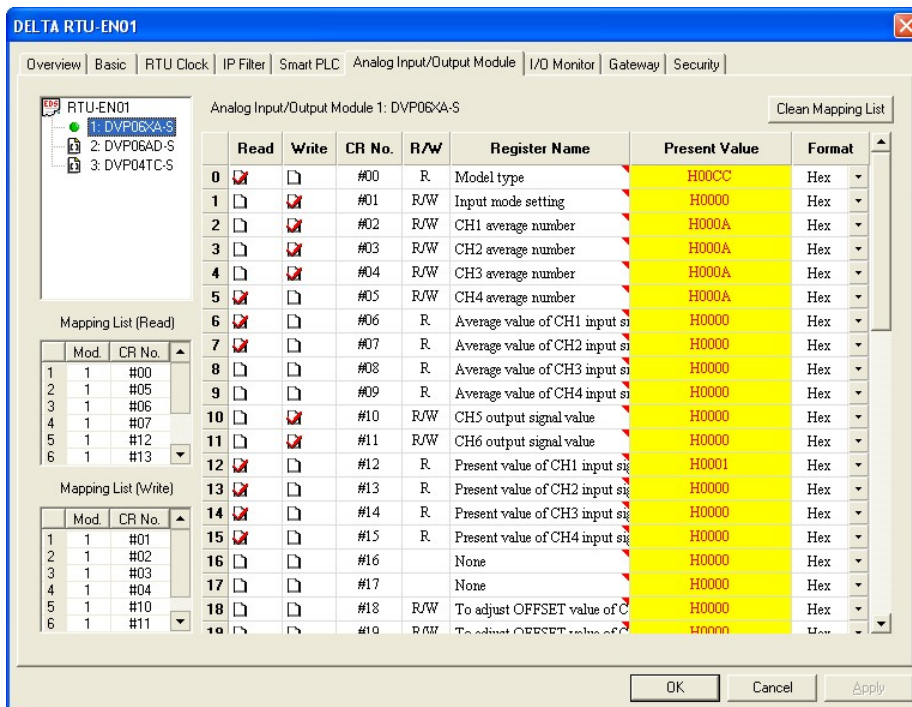

3. Use DCISoft for DVPEN01-SL to set start addresses and numbers. (RX: M2000~M2009; RY: M3000~M3009; RCR (Reading): D2000~D2009; RCR (Writing): D3000~D3009)

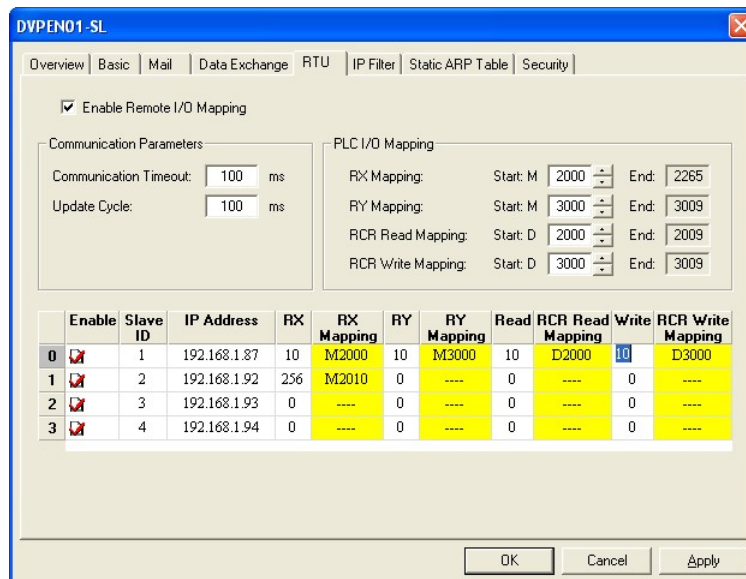

4. Edit a ladder diagram, and download it to DVPEN01-SL. The program edited is like the one shown below.

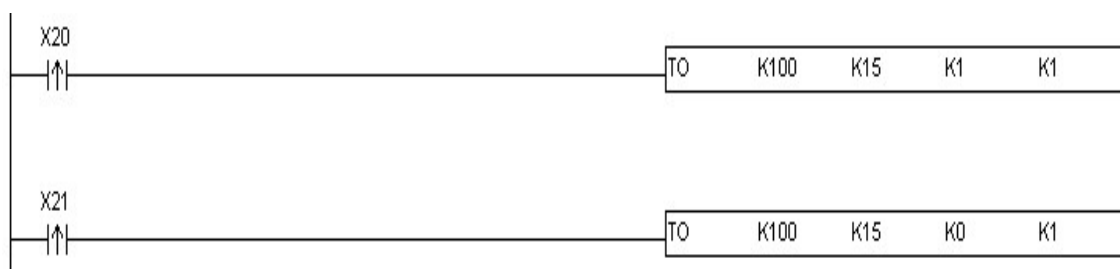

Explanations:

1. Enabling mapping: CR15=1
2. Disabling mapping: CR15=0
3. After CR#15 is enabled, M2000~M2009 and D2000~D2009 will be used to read data, and present values will be read before M3000~M3009 and D3000~D3009 are used to write data.
4. During the execution of mapping, other devices can not be used to modify the values in mapping registers.

## 6.15 Application of the MELSEC Protocol

Application	Using <b>Always Enable</b> in the <b>Enable Condition</b> drop-down list box to read/write registers in a Mitsubishi PLC DVP28SV+DVPEN01-SL→Mitsubishi PLC
Network environment	(1) Use a static IP address. (2) The IP address of DVPEN01-SL is 192.168.1.5, and the sending communication port is 9002. (3) The IP address of RTU-EN01 is 192.168.1.39, and the receiving communication port is 9002. (4) Data mapping: D100~D199 in DVP28SV are mapped onto D100~D199 in the Mitsubishi PLC, and D0~D99 in the Mitsubishi PLC are mapped onto D0~D99 in DVP28SV.

※ Firmware version 2.10 and above support this function.

※ Please visit the Mitsubishi website for more information about the Mitsubishi PLC models which support the MELSEC communication protocol.

1. Please refer to section 6.1 for more information about setting communication.
2. Use the Mitsubishi software to set the IP address of the Mitsubishi PLC and the communication parameters.
  - Communication protocol: MC protocol
  - Communication mode: UDP
  - Communication port: 9002
3. Write a program for the MPU, and download it to DVPEN01-SL. The program designed is like the one shown below.



4. Use DCISof to set data exchange for DVPEN01-SL.

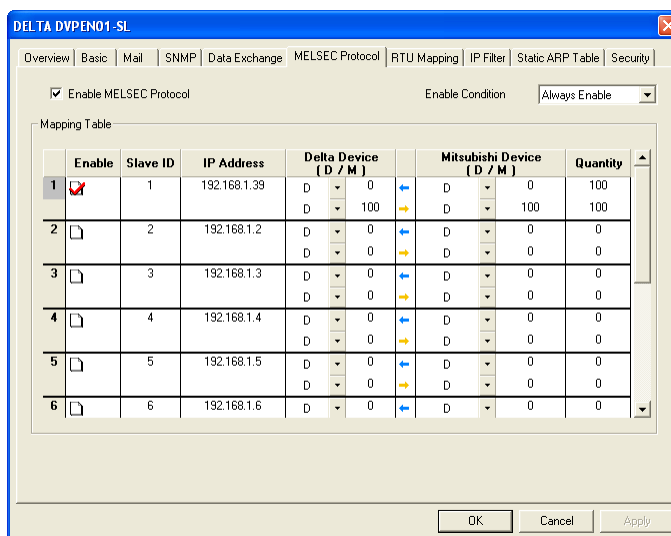

※ After the settings are downloaded, DVPEN01-SL will read the data in D0~D99 in the Mitsubishi PLC into D0~D99 in DVP28SV, and write the data in D100~D199 in DVP28SV into D100~D199 in the Mitsubishi PLC.