



# Delta Embedded Industrial PC Operation Manual J1900 Series



[www.deltaww.com](http://www.deltaww.com)

 **DELTA**  
Smarter. Greener. Together.



Smarter. Greener. Together.

## Industrial Automation Headquarters

### Delta Electronics, Inc.

Taoyuan Technology Center  
No.18, Xinglong Rd., Taoyuan District,  
Taoyuan City 33068, Taiwan  
TEL: 886-3-362-6301 / FAX: 886-3-371-6301

### Asia

#### Delta Electronics (Shanghai) Co., Ltd.

No.182 Minyu Rd., Pudong Shanghai, P.R.C.  
Post code : 201209  
TEL: 86-21-6872-3988 / FAX: 86-21-6872-3996  
Customer Service: 400-820-9595

#### Delta Electronics (Japan), Inc.

Tokyo Office  
Industrial Automation Sales Department  
2-1-14 Shibadaimon, Minato-ku  
Tokyo, Japan 105-0012  
TEL: 81-3-5733-1155 / FAX: 81-3-5733-1255

#### Delta Electronics (Korea), Inc.

Seoul Office  
1511, 219, Gasan Digital 1-Ro., Geumcheon-gu,  
Seoul, 08501 South Korea  
TEL: 82-2-515-5305 / FAX: 82-2-515-5302

#### Delta Energy Systems (Singapore) Pte Ltd.

4 Kaki Bukit Avenue 1, #05-04, Singapore 417939  
TEL: 65-6747-5155 / FAX: 65-6744-9228

#### Delta Electronics (India) Pvt. Ltd.

Plot No.43, Sector 35, HSIIDC Gurgaon,  
PIN 122001, Haryana, India  
TEL: 91-124-4874900 / FAX : 91-124-4874945

#### Delta Electronics (Thailand) PCL.

909 Soi 9, Moo 4, Bangpoo Industrial Estate (E.P.Z),  
Pattana 1 Rd., T.Phraksa, A.Muang,  
Samutprakarn 10280, Thailand  
TEL: 66-2709-2800 / FAX : 662-709-2827

#### Delta Energy Systems (Australia) Pty Ltd.

Unit 20-21/45 Normanby Rd., Notting Hill Vic 3168, Australia  
TEL: 61-3-9543-3720

### Americas

#### Delta Electronics (Americas) Ltd.

Raleigh Office  
P.O. Box 12173, 5101 Davis Drive,  
Research Triangle Park, NC 27709, U.S.A.  
TEL: 1-919-767-3813 / FAX: 1-919-767-3969

#### Delta Greentech (Brasil) S/A

São Paulo Office  
Rua Itapeva, 26 – 3º Andar - Bela Vista  
CEP: 01332-000 – São Paulo – SP - Brasil  
TEL: 55-11-3530-8642 / 55-11-3530-8640

#### Delta Electronics International Mexico S.A. de C.V.

Mexico Office  
Vía Dr. Gustavo Baz No. 2160, Colonia La Loma,  
54060 Tlalnepanitla Estado de Mexico  
TEL: 52-55-2628-3015 #3050/3052

### EMEA

#### Headquarters: Delta Electronics (Netherlands) B.V.

Sales: Sales.IA.EMEA@deltaww.com  
Marketing: Marketing.IA.EMEA@deltaww.com  
Technical Support: iatechnicalsupport@deltaww.com  
Customer Support: Customer-Support@deltaww.com  
Service: Service.IA.emea@deltaww.com  
TEL: +31(0)40 800 3800

#### BENELUX: Delta Electronics (Netherlands) B.V.

De Witbogt 20, 5652 AG Eindhoven, The Netherlands  
Mail: Sales.IA.Benelux@deltaww.com  
TEL: +31(0)40 800 3800

#### DACH: Delta Electronics (Netherlands) B.V.

Coesterweg 45, D-59494 Soest, Germany  
Mail: Sales.IA.DACH@deltaww.com  
TEL: +49(0)2921 987 0

#### France: Delta Electronics (France) S.A.

ZI du bois Challand 2, 15 rue des Pyrénées,  
Lisses, 91090 Evry Cedex, France  
Mail: Sales.IA.FR@deltaww.com  
TEL: +33(0)1 69 77 82 60

#### Iberia: Delta Electronics Solutions (Spain) S.L.U

Ctra. De Villaverde a Vallecas, 265 1º Dcha Ed.  
Hormigueras – P.I. de Vallecas 28031 Madrid  
TEL: +34(0)91 223 74 20

C/Llull, 321-329 (Edifici CINC) | 22@Barcelona, 08019 Barcelona

Mail: Sales.IA.Iberia@deltaww.com  
TEL: +34 93 303 00 60

#### Italy: Delta Electronics (Italy) S.r.l.

Ufficio di Milano Via Senigallia 18/2 20161 Milano (MI)  
Piazza Grazioli 18 00186 Roma Italy  
Mail: Sales.IA.Italy@deltaww.com  
TEL: +39 02 64672538

#### Russia: Delta Energy System LLC

Vereyskaya Plaza II, office 112 Vereyskaya str.  
17 121357 Moscow Russia  
Mail: Sales.IA.RU@deltaww.com  
TEL: +7 495 644 3240

#### Turkey: Delta Greentech Elektronik San. Ltd. Sti. (Turkey)

Şerifali Mah. Hendem Cad. Kule Sok. No:16-A  
34775 Ümraniye – İstanbul  
Mail: Sales.IA.Turkey@deltaww.com  
TEL: + 90 216 499 9910

#### GCC: Delta Energy Systems AG (Dubai BR)

P.O. Box 185668, Gate 7, 3rd Floor, Hamarain Centre  
Dubai, United Arab Emirates  
Mail: Sales.IA.MEA@deltaww.com  
TEL: +971(0)4 2690148

#### Egypt + North Africa: Delta Electronics

511 Cairo Business Plaza, North 90 street,  
New Cairo, Cairo, Egypt  
Mail: Sales.IA.MEA@deltaww.com

# Delta Embedded Industrial PC Operation

## Manual - J1900 Series

### Copyright notice

©Delta Electronics, Inc. All rights reserved.

All information contained in this user manual is the exclusive property of Delta Electronics Inc. (hereinafter referred to as "Delta ") and is protected by copyright law and all other laws. Delta retains the exclusive rights of this user manual in accordance with the copyright law and all other laws. No parts in this manual may be reproduced, transmitted, transcribed, translated or used in any other ways without the prior consent of Delta.

### Limitation of Liability

The contents of this user manual are only for the use of the embedded industrial PC manufactured by Delta. Except as defined in special mandatory laws, Delta provides this user manual “as is” and does not offer any kind of warranty through this user manual for using the product, either express or implied, including but not limited to the following: (i) this product will meet your needs or expectations; (ii) the information contained in the product is current and correct; (iii) the product does not infringe any rights of any other person. You shall bear your own risk to use this product.

In no event shall Delta, its subsidiaries, affiliates, managers, employees, agents, partners and licensors be liable for any direct, indirect, incidental, special, derivative or consequential damages (including but not limited to the damages for loss of profits, goodwill, use or other intangible losses) unless the laws contains special mandatory provisions to the contrary.

Delta reserves the right to make changes to the user manual and the products described in the user manual without prior notice and afterwards.

- **Warranty Terms and Conditions:**

This warranty is valid for 18 months. Consideration for special requirement is based on the contract signed by the two parties.

- **Trademarks:**

All trademarks mentioned in this manual are registered to the respective companies:

AMI® is the registered trademark of AMI Company.

Intel®, Celeron® are the registered trademarks of Intel.

Windows 7, Windows 10 are the registered trademarks of Microsoft.

- **Notes On Use:**

This is as Class A product and may cause EMI (Electro Magnetic Interference) in the living environment which users are required to take appropriate measure.

- **Warning:**

Notice (Marked on operating instructions and its packaging):

- (1) Operate the device for 30 minutes and take 10-minute break.
- (2) Do not let young children less than 2 years old stare at the screen, nor let elder children stare at the screen for more than 1 hour.
- (3) Overuse of devices can affect the eyes.
- (4) Risk of explosion may occur when batteries are inaccurately changed. Please handle the batteries based on the instructions provided by the manufacturer.

- **Safety Instructions:**

We disclaim liability for inadequate installation or use of device that led to direct or indirect damages and with intent or not.

1. Carefully read the operation manual before using the product, and keep it for future reference.
2. Before connecting power supply to the product, please confirm the voltage is compliant with the requirement of the device.
3. To avoid electric shock or damage to the product, please unplug the power cord from the socket before cleaning the device with wet cloth.
4. Do not use liquid or stain remover spray aerosol cleaner to clean up the device.
5. To avoid short circuit or fire, please do not let any liquid get into or splash into the product.
6. For device that needs power cords, there must be an easy-to-reach power socket near the device.
7. Do not use the product in a damp environment.
8. Make sure the device is placed on a solid surface before installation; accidental drop or tipping may cause malfunction or damage to the device.
9. All power cords need to be unplugged first before connecting or unplugging any signal cables.
10. To avoid unnecessary damage caused by frequent power-on/off, wait at least 30 seconds after restarting the computer.
11. When product is not used for a long time, please disconnect the power cord to avoid damages caused by transient voltage.
12. Some precision devices are sensitive to ESD and needs to be installed or dismantled via its workstation for enhancement.
13. Provide excellent heat dissipation and system ventilation.
14. Do not open or dismantle the device by yourself. Please let professional maintenance person open the device due to safety concerns.

# Delta Embedded Industrial PC Operation Manual- J1900 Series

## Revision History

Version	Revision	Date
1 <sup>st</sup>	The first version was published.	2019/02/27

# Delta Embedded Industrial PC Operation Manual-J1900 Series

## Contents

### Chapter 1 Product Specification

<b>1.1</b>	<b>Introduction</b> .....	<b>1-2</b>
<b>1.2</b>	<b>Host Controller Specification</b> .....	<b>1-2</b>
1.2.1	DIAVH-IPC00J10x Series .....	1-2
1.2.2	DIAVH-PPCxxJ10x Series .....	1-3
<b>1.3</b>	<b>Dimensions</b> .....	<b>1-5</b>
1.3.1	DIAVH-IPC00J10x Series .....	1-5
1.3.2	DIAVH-PPC10J10x Series .....	1-6
1.3.3	DIAVH-PPC12J10x Series .....	1-6
1.3.4	DIAVH-PPC15J10x Series .....	1-7
1.3.5	DIAVH-PPC17J10x Series .....	1-7

### Chapter 2 I/O Interface

<b>2.1</b>	<b>Diagrams of I/O Interface</b> .....	<b>2-2</b>
2.1.1	DIAVH-IPC00J10x Series .....	2-2
2.1.2	DIAVH-PPC10J10x Series .....	2-3
2.1.3	DIAVH-PPC12J10x Series .....	2-4
2.1.4	DIAVH-PPC15J10x Series .....	2-5
2.1.5	DIAVH-PPC17J10x Series .....	2-6
<b>2.2</b>	<b>I/O Port Pins</b> .....	<b>2-7</b>
2.2.1	Standard DB9 Port .....	2-7
2.2.2	RJ-45 LAN Port .....	2-8
2.2.3	VGA Port .....	2-9
2.2.4	USB 2.0 Port .....	2-9
2.2.5	USB 3.0 Port .....	2-10
2.2.6	HDMI A Type Port .....	2-10
2.2.7	GPIO Port .....	2-11

2.2.8	DC12V Power Port.....	2-11
-------	-----------------------	------

### **Chapter 3 AMI BIOS Utility**

<b>3.1</b>	<b>Starting BIOS .....</b>	<b>3-2</b>
<b>3.2</b>	<b>Hotkey Shortcuts.....</b>	<b>3-2</b>
<b>3.3</b>	<b>Main Menu .....</b>	<b>3-2</b>
<b>3.4</b>	<b>Advanced Menu .....</b>	<b>3-3</b>
<b>3.5</b>	<b>Chipset Menu .....</b>	<b>3-4</b>
<b>3.6</b>	<b>Security Menu.....</b>	<b>3-4</b>
<b>3.7</b>	<b>Boot Menu .....</b>	<b>3-5</b>
<b>3.8</b>	<b>Save &amp; Exit Menu.....</b>	<b>3-5</b>
<b>3.9</b>	<b>Restore AC Power Loss .....</b>	<b>3-6</b>

### **Chapter 4 Transportation and Storage Requirements**

<b>4.1</b>	<b>Unpack and Check the Delivery Package.....</b>	<b>4-2</b>
<b>4.2</b>	<b>Transportation.....</b>	<b>4-2</b>
<b>4.3</b>	<b>Storage Requirements .....</b>	<b>4-2</b>

### **Appendix A Touch Screen Usage and Calibration**

<b>A.1</b>	<b>Using the Touch Screen.....</b>	<b>A-2</b>
<b>A.2</b>	<b>Four Points Calibration .....</b>	<b>A-2</b>

---

# Chapter 1 Product Specification

## Table of Contents

- 1.1 Introduction..... 1-2**
- 1.2 Host Controller Specification..... 1-2**
  - 1.2.1 DIAVH-IPC00J10x Series ..... 1-2
  - 1.2.2 DIAVH-PPCxxJ10x Series..... 1-3
- 1.3 Dimensions ..... 1-5**
  - 1.3.1 DIAVH-IPC00J10x Series ..... 1-5
  - 1.3.2 DIAVH-PPC10J10x Series..... 1-6
  - 1.3.3 DIAVH-PPC12J10x Series..... 1-6
  - 1.3.4 DIAVH-PPC15J10x Series..... 1-7
  - 1.3.5 DIAVH-PPC17J10x Series..... 1-7



## 1.1 Introduction

DIAVH-IPC and PPC series are embedded industrial PCs featuring low power, high-performance and with sealed fan-less design. In addition, the product adopts excellent high-strength aluminum-alloy material including heat sinks made from dense aluminum-alloy.

The product is equipped with advanced Intel® Celeron J1900 quad core processor, standard 4G RAM and extended up to 8GB in memory. It supports operating systems such as Windows 7/10 and Linux.

For IPC product series, the embedded device is applied in solutions such as in-vehicle computing systems, intelligent transportation and industrial automation control. As for PPC product series, the device is suitable for mechanical rubber, solar photovoltaic (PV), vehicle control and general industrial automation industries (e.g. paper, environmental related).

## 1.2 Host Controller Specification

The J1900 series features five hardware specifications including fan-less IPC and 10/12/15/17-inch PPCs. Below are details regarding each specification.

### 1.2.1 DIAVH-IPC00J10x Series

<b>Applicable Models</b>	DIAVH-IPC00J100, DIAVH-IPC00J102, DIAVH-IPC00J103, DIAVH-IPC00J104
--------------------------	--

Item	Specification
CPU	Intel® Celeron J1900 2.42GHz processor
RAM	4GB DDR3 1600MHz, max. up to 8GB
SSD	128GB mSata SSD
Network	2x Intel® I211 Gigabit Ethernet Controller
Audio	1x Standard frequency I/O
Expansion	Supports mini PCIE interface and Wi-Fi communication modules
External I/O	<ul style="list-style-type: none"> <li>● Serial port: COM 1~5 (RS-232), COM 6 (RS-422/485)</li> <li>● 5 x USB 2.0, 1 x USB 3.0 (blue)</li> <li>● 1 x VGA output</li> <li>● 1 x HDMI output</li> </ul>
Dimension	Rack NOT included: 211.5mm (L) × 200mm (W) × 67mm (H) ; Rack included: 251.9mm (L) × 200mm(W) × 71.6mm (H)
Structure	<ul style="list-style-type: none"> <li>● Case: High-strength aluminum alloy, sand blasting anodizing aluminum</li> <li>● Color: Black</li> <li>● Thermal conductivity: An integrated aluminum case with active heat conduction design</li> <li>● Material: Aluminum alloy heat sink</li> </ul>
Weight	Net weight: 2.8Kg; Gross weight: 3.5Kg
Temperature	<ul style="list-style-type: none"> <li>● Operation temperature: -20°C ~ 40°C</li> <li>● Storage temperature: -40°C ~ 70°C</li> </ul>
Humidity	95% @ 40°C (non-condensing)

Item	Specification
EMC	<ul style="list-style-type: none"> <li>● Level A, and GB9254-1998</li> <li>● GB/T 17618</li> </ul>
Reliability	<ul style="list-style-type: none"> <li>● Mean time between failures (MTBF): <math>\geq 5000\text{h}</math></li> <li>● Mean time to recovery (MTTR): <math>\leq 0.5\text{h}</math></li> </ul>
Certification	CE, FCC
Environment	<ul style="list-style-type: none"> <li>● Anti-vibration: 5-19Hz/1.0mm amplitude ; 19-200Hz/1.0g acceleration</li> <li>● Anti-shock: 10g acceleration, 11ms duration</li> </ul>
Power	<ul style="list-style-type: none"> <li>● Standard VT: Input voltage/ frequency: 100~240VAC/ 50~60Hz Input voltage/ current: 12VDC/5A</li> <li>● Power consumption: 7 W (stand-by); 16 W (running max. power 100%)</li> </ul>

### 1.2.2 DIAVH-PPCxxJ10x Series

<b>Applicable Models</b>	DIAVH-PPC10J100, DIAVH-PPC10J102, DIAVH-PPC10J103, DIAVH-PPC10J104, DIAVH-PPC12J100, DIAVH-PPC12J102, DIAVH-PPC12J103, DIAVH-PPC12J104, DIAVH-PPC15J100, DIAVH-PPC15J102, DIAVH-PPC15J103, DIAVH-PPC15J104, DIAVH-PPC17J100, DIAVH-PPC17J102, DIAVH-PPC17J103, DIAVH-PPC17J104
--------------------------	--

Item	Specification
CPU	Intel® Celeron J1900 2.42GHz processor
RAM	4GB DDR3 1600MHz, max. up to 8GB
SSD	128GB mSata SSD
Network	2 x Intel® I211 Gigabit Ethernet Controller
Audio	1 x Standard frequency I/O
Expansion	Supports mini PCIE interface and Wi-Fi communication modules
External I/O	<ul style="list-style-type: none"> <li>● Serial port: COM 1~3 (RS-232), COM 4 (RS-422/485)</li> <li>● 3 x USB 2.0, 1 x USB 3.0 (blue)</li> <li>● 1 x VGA output</li> <li>● 1 x HDMI output</li> <li>● 1 x GPIO DB9 (10"/12" types)</li> </ul>
LED Screen	10" PPC <ul style="list-style-type: none"> <li>● Display: 9.7" TFT LED</li> <li>● Resolution: 1024x768</li> <li>● Brightness: 350cd/m<sup>2</sup></li> <li>● Contrast: 800 : 1</li> <li>● Viewing angle (CR <math>\geq 10</math>): 170° (V) / 170° (H)</li> </ul>
	12" PPC <ul style="list-style-type: none"> <li>● Display: 12.1" TFT LED</li> <li>● Resolution: 1024x768</li> <li>● Brightness: 450cd/m<sup>2</sup></li> <li>● Contrast: 700 : 1</li> <li>● Viewing angle (CR <math>\geq 10</math>): 160° (V) / 160° (H)</li> </ul>

Item	Specification	
	15" PPC	<ul style="list-style-type: none"> <li>● Display: 15" TFT LED</li> <li>● Resolution: 1024x768</li> <li>● Brightness: 300cd/m<sup>2</sup></li> <li>● Contrast: 1500 : 1</li> <li>● Viewing angle (CR ≥ 10) : 140° (V) / 140° (H)</li> </ul>
LED Screen	17" PPC	<ul style="list-style-type: none"> <li>● Display: 17" TFT LED</li> <li>● Resolution: 1280x1024</li> <li>● Brightness: 250cd/m<sup>2</sup></li> <li>● Contrast: 1000 : 1</li> <li>● Viewing angle (CR ≥ 5): 150° (V) / 140° (H)</li> </ul>
Touch Screen	<ul style="list-style-type: none"> <li>● Connection: USB</li> <li>● Type: 5-wire resistive touch</li> </ul>	
Dimensions	<p>10" PPC : 258mm (L) × 198mm (W) × 57.5mm (H) ;</p> <p>12" PPC : 317mm (L) × 246mm (W) × 66mm (H) ;</p> <p>15" PPC : 380mm (L) × 300mm (W) × 59mm (H) ;</p> <p>17" PPC : 400mm (L) × 320mm (W) × 59mm (H) ;</p>	
Structure	<ul style="list-style-type: none"> <li>● Case: High-strength aluminum alloy, sand blasting anodizing aluminum</li> <li>● Color: Silver</li> <li>● Thermal conductivity: An integrated aluminum case with active heat conduction design</li> <li>● Material: Aluminum alloy heat sink</li> </ul>	
Weights	<p>10" PPC: Net weight: 2.5Kg; Gross weight: 4.0Kg</p> <p>12" PPC: Net weight: 4.3Kg; Gross weight: 5.7Kg</p> <p>15" PPC: Net weight: 5.2Kg; Gross weight: 6.8Kg</p> <p>17" PPC: Net weight: 6.1Kg; Gross weight: 8.0Kg</p>	
Temperature	<ul style="list-style-type: none"> <li>● Operation temperature: -10°C ~ 40°C</li> <li>● Storage temperature: -20°C ~ 60°C</li> </ul>	
Humidity	95% @ 40°C (non-condensing)	
EMC	<ul style="list-style-type: none"> <li>● Level A, and GB9254-1998</li> <li>● GB/T 17618</li> </ul>	
Reliability	<ul style="list-style-type: none"> <li>● Mean time between failures (MTBF): ≥ 5000h</li> <li>● Mean time to recovery (MTTR): ≤ 0.5h</li> </ul>	
Certification	CE, FCC	
Environment	<ul style="list-style-type: none"> <li>● Anti-vibration: 5-19Hz/1.0mm amplitude : 19-200Hz/1.0g acceleration</li> <li>● Anti-shock:10g acceleration, 11ms duration</li> </ul>	
Power	<ul style="list-style-type: none"> <li>● Standard VT: Input voltage/ frequency: 100~240VAC/50~60Hz Input voltage/ current: 12VDC/5A</li> </ul>	
	10" PPC	<ul style="list-style-type: none"> <li>● Power consumption: 10 W (stand-by); 19 W (running max. power 100%)</li> </ul>

Item	Specification	
12" PPC	●	Power consumption: 15 W (stand-by); 20 W (running max. power 100%)
15" PPC	●	Power consumption: 11 W (stand-by); 26 W (running max. power 100%)
17" PPC	●	Power consumption: 11 W (stand-by); 30 W (running max. power 100%)

## 1.3 Dimensions

### 1.3.1 DIAVH-IPC00J10x Series

Applicable Models	DIAPH-IPC00J100, DIAVH-IPC00J102, DIAVH-IPC00J103, DIAVH-IPC00J104
-------------------	--

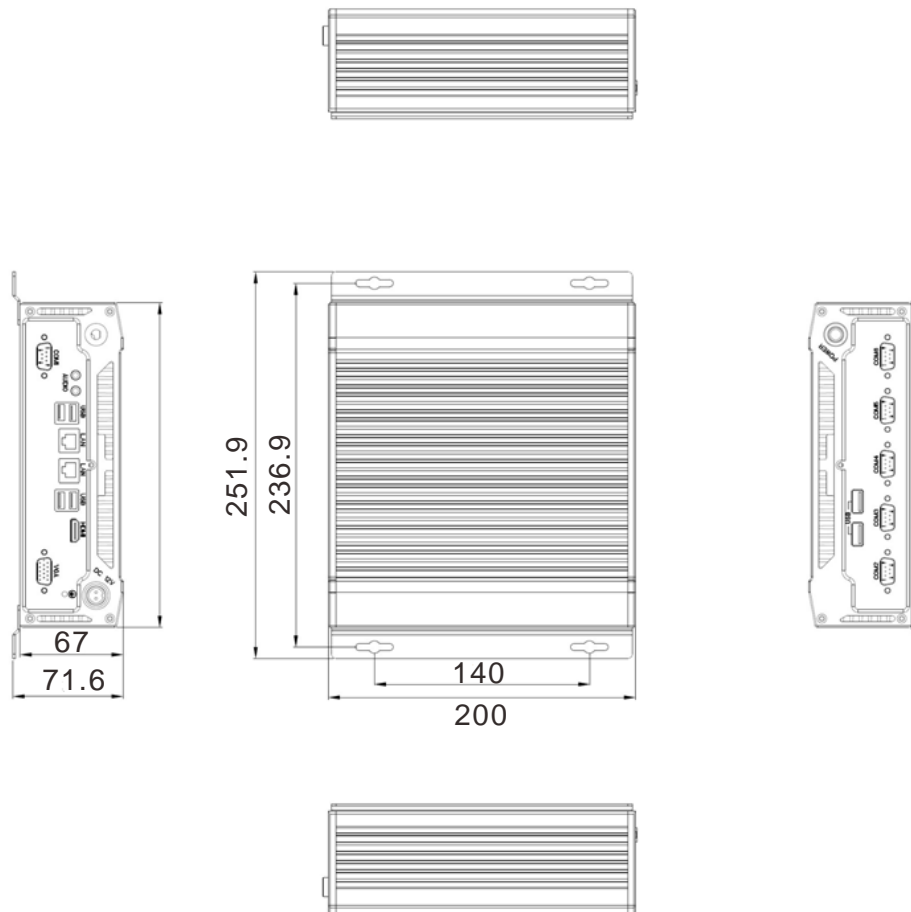

Unit : mm

### 1.3.2 DIAVH-PPC10J10x Series

<b>Applicable Models</b>	DIAVH-PPC10J100, DIAVH-PPC10J102, DIAVH-PPC10J103, DIAVH-PPC10J104
--------------------------	--

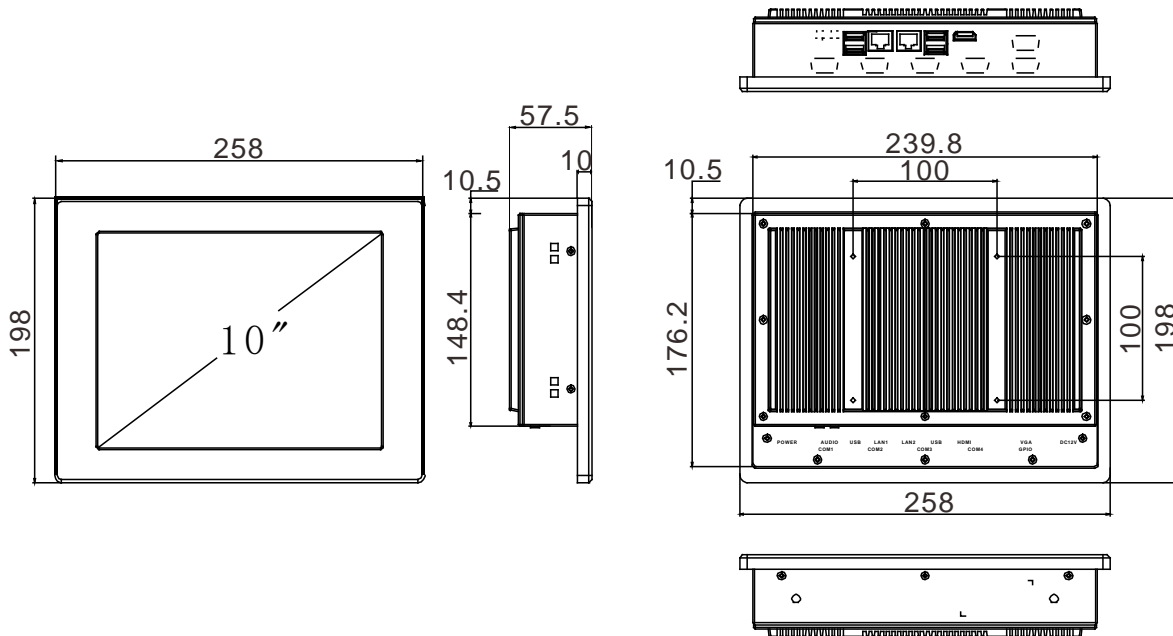

Unit : mm

### 1.3.3 DIAVH-PPC12J10x Series

<b>Applicable Models</b>	DIAVH-PPC12J100, DIAVH-PPC12J102, DIAVH-PPC12J103, DIAVH-PPC12J104
--------------------------	--

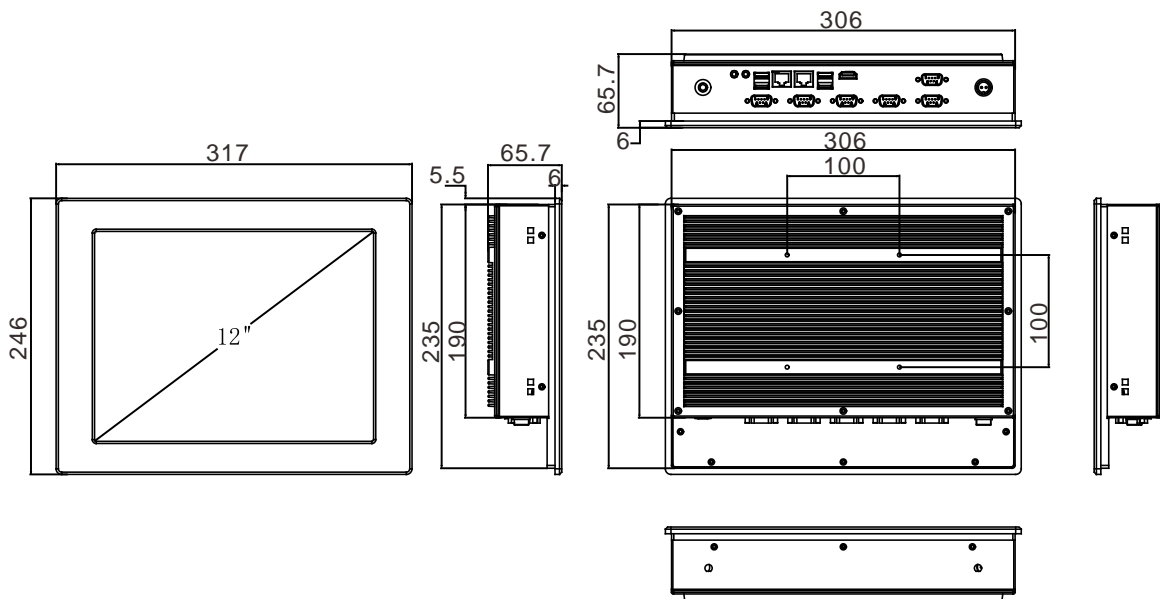

Unit : mm

### 1.3.4 DIAVH-PPC15J10x Series

<b>Applicable Models</b>	DIAVH-PPC15J100, DIAVH-PPC15J102, DIAVH-PPC15J103, DIAVH-PPC15J104
--------------------------	--

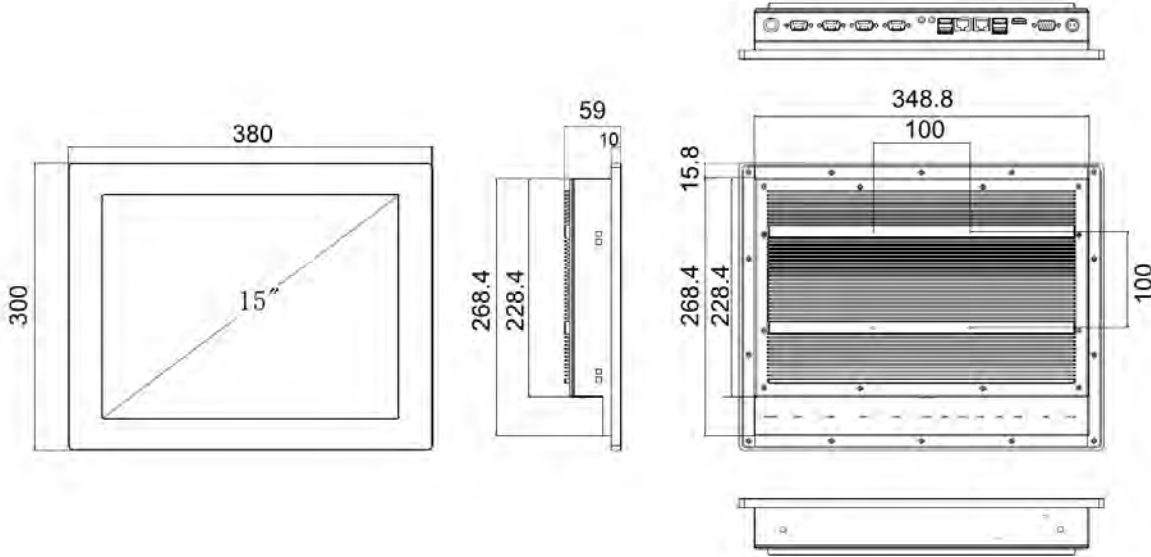

Unit : mm

### 1.3.5 DIAVH-PPC17J10x Series

<b>Applicable Models</b>	DIAVH-PPC17J100, DIAVH-PPC17J102, DIAVH-PPC17J103, DIAVH-PPC17J104
--------------------------	--

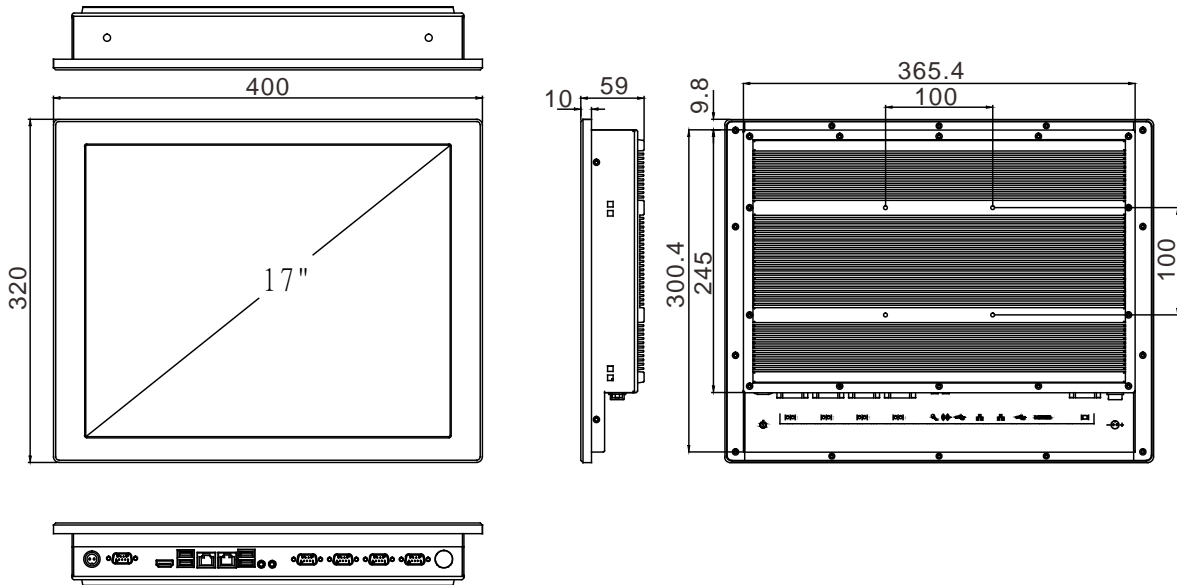

Unit : mm

## MEMO

1

---

## Chapter 2 I/O Interface

### Table of Contents

<b>2.1</b>	<b>Diagrams of I/O Interface</b> .....	<b>2-2</b>
2.1.1	DIAVH-IPC00J10x Series .....	2-2
2.1.2	DIAVH-PPC10J10x Series.....	2-3
2.1.3	DIAVH-PPC12J10x Series.....	2-4
2.1.4	DIAVH-PPC15J10x Series.....	2-5
2.1.5	DIAVH-PPC17J10x Series.....	2-6
<b>2.2</b>	<b>I/O Port Pins</b> .....	<b>2-7</b>
2.2.1	Standard DB9 Port .....	2-7
2.2.2	RJ-45 LAN Port .....	2-8
2.2.3	VGA Port.....	2-9
2.2.4	USB 2.0 Port .....	2-9
2.2.5	USB 3.0 Port .....	2-10
2.2.6	HDMI A Type Port .....	2-10
2.2.7	GPIO Port .....	2-11
2.2.8	DC12V Power Port.....	2-11



## 2.1 Diagrams of I/O Interface

### 2.1.1 DIAVH-IPC00J10x Series

<b>Applicable Models</b>	DIAVH-IPC00J100, DIAVH-IPC00J103, DIAVH-IPC00J102, DIAVH-IPC00J104
--------------------------	--

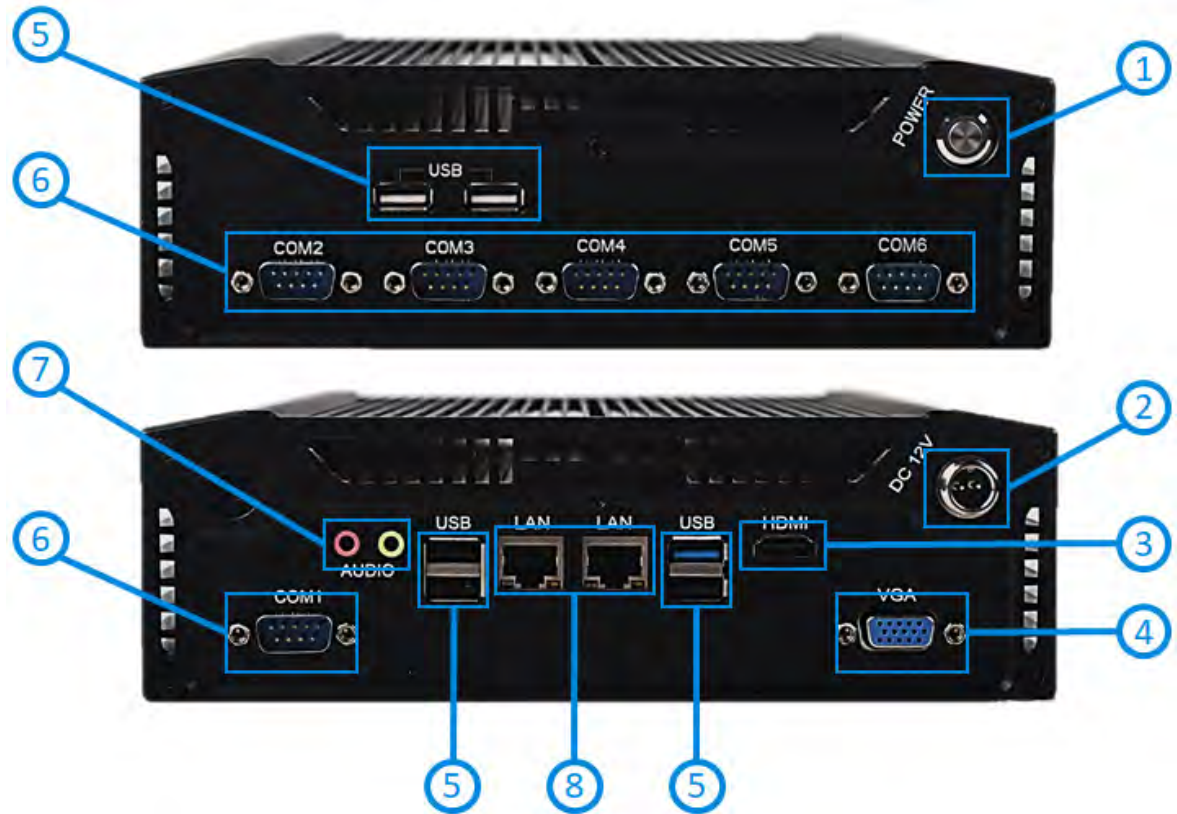

No.	Item	No.	Item
1	Power Switch	5	USB2.0 / USB3.0
2	Power Connector	6	RS-232 / RS-422 / RS-485
3	HDMI	7	MIC-In / Line-Out
4	VGA	8	Ethernet

### 2.1.2 DIAVH-PPC10J10x Series

<b>Applicable Models</b>	DIAVH-PPC10J100, DIAVH-PPC10J103, DIAVH-PPC10J102, DIAVH-PPC10J104
--------------------------	--

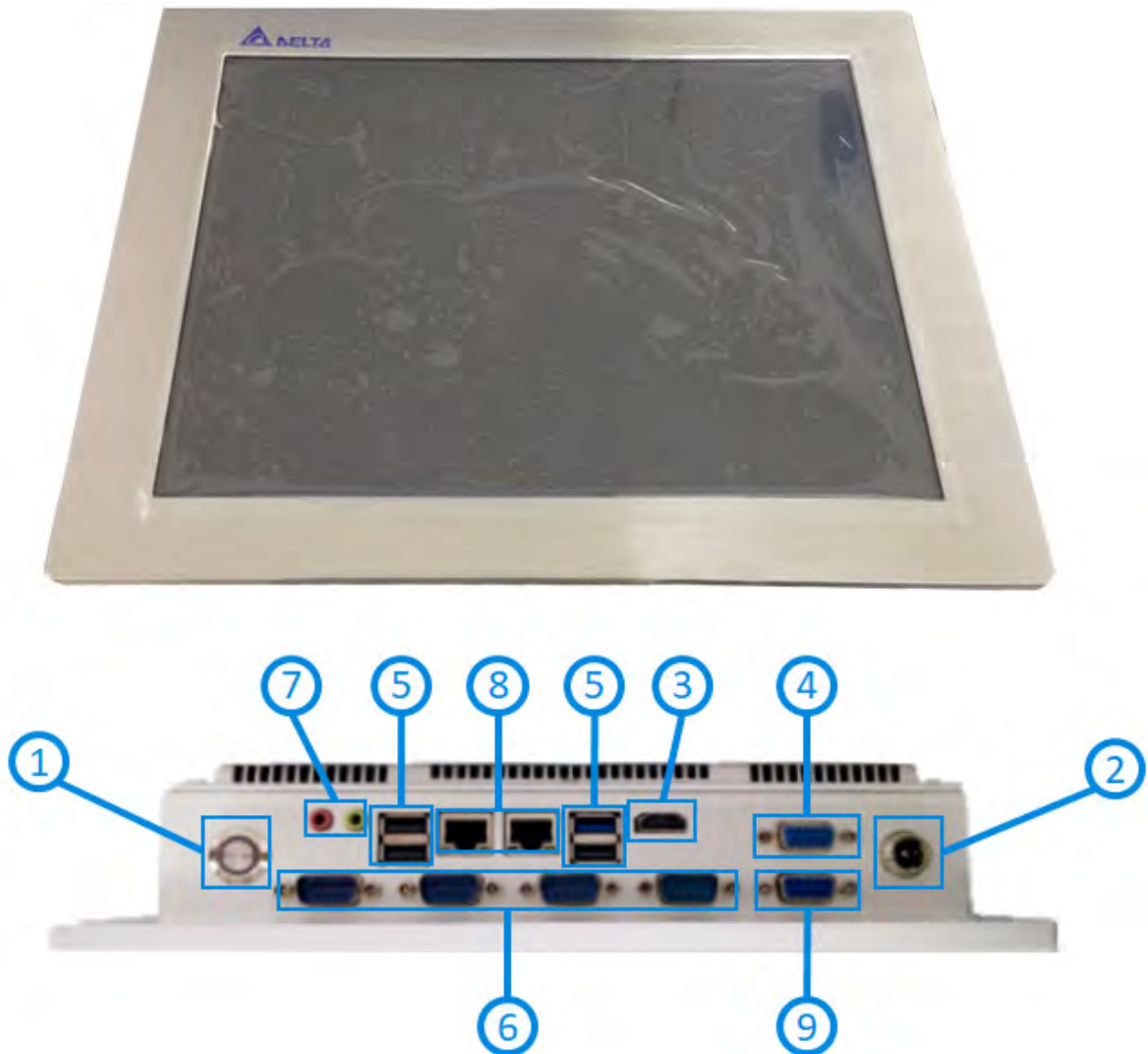

No.	Item	No.	Item
1	Power Switch	6	RS-232 / RS-422 / RS-485
2	Power Connector	7	MIC-In / Line-Out
3	HDMI	8	Ethernet
4	VGA	9	GPIO
5	USB2.0 / USB3.0		

### 2.1.3 DIAVH-PPC12J10x Series

<b>Applicable Models</b>	DIAVH-PPC12J100, DIAVH-PPC12J103, DIAVH-PPC12J102, DIAVH-PPC12J104
--------------------------	--

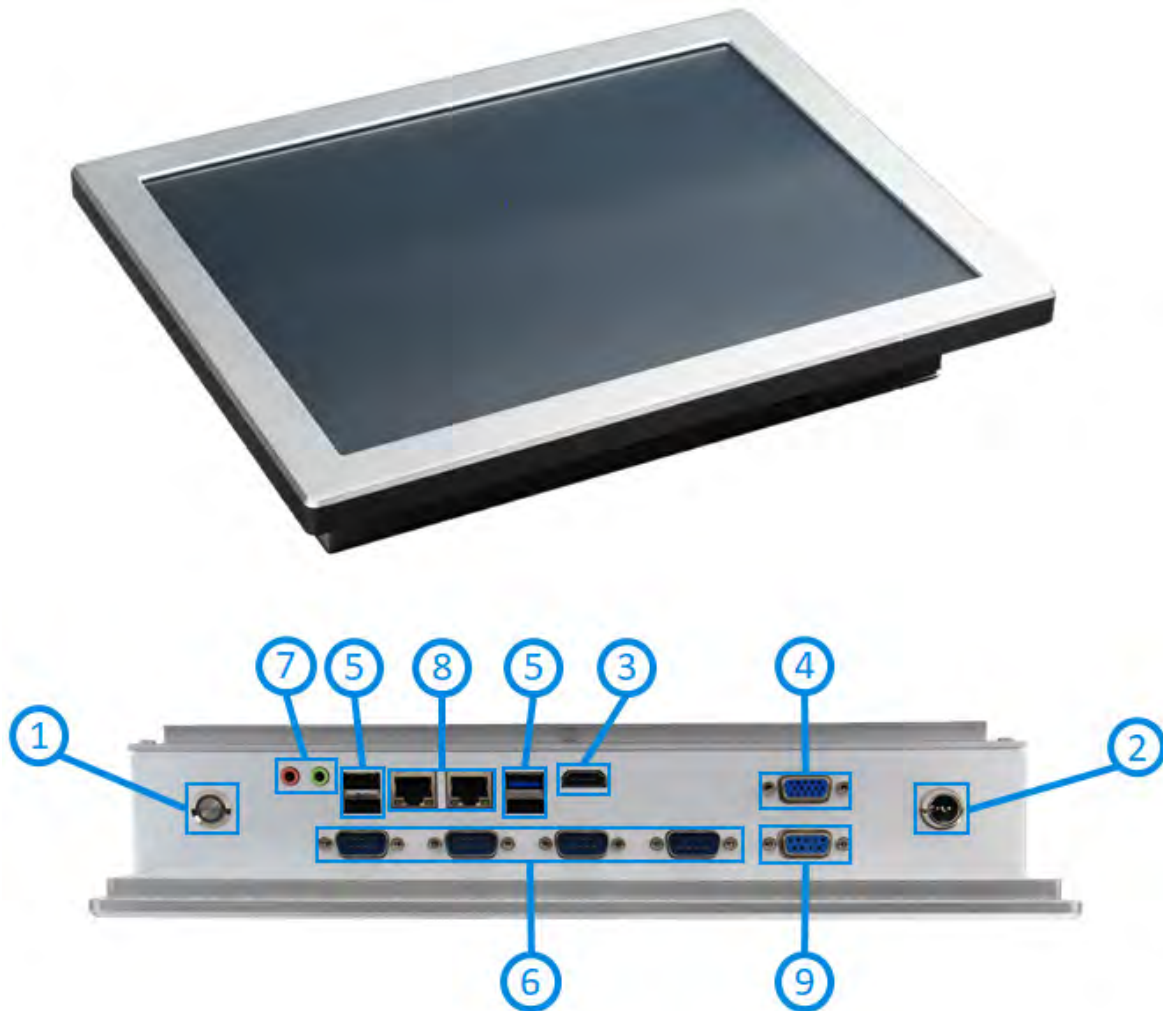

No.	Item	No.	Item
1	Power Switch	6	RS-232 / RS-422 / RS-485
2	Power Connector	7	MIC-In / Line-Out
3	HDMI	8	Ethernet
4	VGA	9	GPIO
5	USB2.0 / USB3.0		

### 2.1.4 DIAVH-PPC15J10x Series

<b>Applicable Models</b>	DIAVH-PPC15J100, DIAVH-PPC15J103, DIAVH-PPC15J102, DIAVH-PPC15J104
--------------------------	--



No.	Item	No.	Item
1	Power Switch	5	USB2.0 / USB3.0
2	Power Connector	6	RS-232 / RS-422 / RS-485
3	HDMI	7	MIC-In / Line-Out
4	VGA	8	Ethernet

### 2.1.5 DIAVH-PPC17J10x Series

<b>Applicable Models</b>	DIAVH-PPC17J100, DIAVH-PPC17J103, DIAVH-PPC17J102, DIAVH-PPC17J104
--------------------------	--



No.	Item	No.	Item
1	Power Switch	5	USB2.0 / USB3.0
2	Power Connector	6	RS-232 / RS-422 / RS-485
3	HDMI	7	MIC-In / Line-Out
4	VGA	8	Ethernet

## 2.2 I/O Port Pins

### 2.2.1 Standard DB9 Port

<b>Applicable Models</b>	DIAVH IPC/PPC series
--------------------------	----------------------

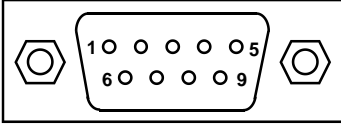
Serial Port	Pin	Communication Interface		
		RS-232	RS-485	RS-422
	1	DCD	DATA+	T+/R+
	2	RXD	DATA-	T-/R-
	3	TXD	-	RXD+
	4	DTR	-	RXD-
	5	GND	GND	GND
	6	DSR	VCC +5V (Standby Input)	VCC +5V (Standby Input)
	7	RTS	-	-
	8	CTS	-	-
	9	RI	-	-

### 2.2.2 RJ-45 LAN Port

<b>Applicable Models</b>	DIAVH IPC/PPC series
--------------------------	----------------------

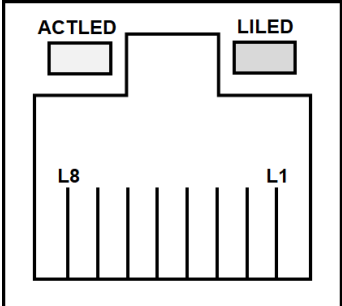
RJ-45	Pin	1000 Base-T	100 Base-T	
	L1	Red	Green	
	L2	Blue	N.C.	
	L3	GND	DETECT	
	L4	GND	GND	
	L5	+5V	GND	
	L6	N.C.	DDC DATA	
	L7	Horizontal Sync	Vertical Sync	
	L8	DDC CLK		
	ACTLED	<b>Network Status Display</b> LED ON: Data transmitting LED OFF: No data transmission		
	LILED	<b>Network Transmission Rate</b> LED (Orange light): 1000Mbps LED (Green light): 100Mbps LED OFF: 10Mbps		

### 2.2.3 VGA Port

<b>Applicable Models</b>	DIAPH IPC/PPC series
--------------------------	----------------------

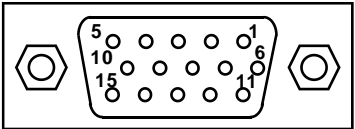
VGA	Pin	Signal	Pin	Signal
	1	Red	2	Green
	3	Blue	4	N.C.
	5	GND	6	DETECT
	7	GND	8	GND
	9	+5V	10	GND
	11	N.C.	12	DDC DATA
	13	Horizontal Sync	14	Vertical Sync
	15	DDC CLK		

### 2.2.4 USB 2.0 Port

<b>Applicable Models</b>	DIAPH IPC/PPC series
--------------------------	----------------------

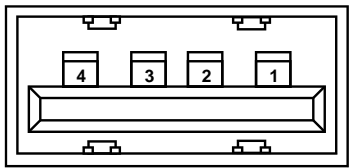
USB 2.0	Pin	Signal
	1	USB VCC +5V
	2	USB Data-
	3	USB Data+
	4	GND



### 2.2.5 USB 3.0 Port

<b>Applicable Models</b>	DIAVH IPC/PPC series
--------------------------	----------------------

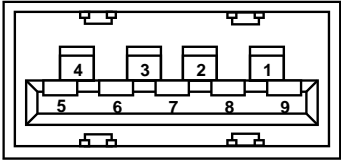
USB 3.0	Pin	Signal
	1	USB VCC +5V
	2	USB Data-
	3	USB Data+
	4	GND
	5	StdA_SSRX-
	6	StdA_SSRX+
	7	GND
	8	StdA_SSTX-
	9	StdA_SSTX+

### 2.2.6 HDMI A Type Port

<b>Applicable Models</b>	DIAVH IPC/PPC series
--------------------------	----------------------

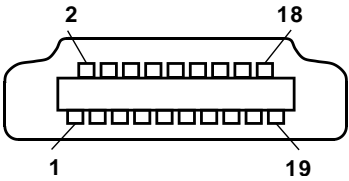
HDMI	Pin	Signal	Pin	Signal
	1	TMDS Data2+	2	TMDS Data2 Shield
	3	TMDS Data2-	4	TMDS Data1+
	5	TMDS Data1 Shield	6	TMDS Data1-
	7	TMDS Data0+	8	TMDS Data0 Shield
	9	TMDS Data0-	10	TMDS Clock+
	11	TMDS Clock Shield	12	TMDS Clock-
	13	CEC	14	Reserved
	15	SCL	16	SDA
	17	DDC/CEC Ground	18	+5V Power
	19	Hot Plug Detect		

## 2.2.7 GPIO Port

<b>Applicable Models</b>	DIAVH-PPC10J100, DIAVH-PPC10J103, DIAVH-PPC10J102, DIAVH-PPC10J104, DIAVH-PPC12J100, DIAVH-PPC12J103, DIAVH-PPC12J102, DIAVH-PPC12J104
--------------------------	--

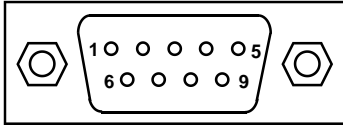
GPIO	Pin	Signal
	1	GP_OUT1
	2	GP_OUT2
	3	GP_OUT3
	4	GP_OUT4
	5	GP_IN1
	6	GP_IN2
	7	GP_IN3
	8	GP_IN4
	9	VCC5

## 2.2.8 DC12V Power Port

<b>Applicable Models</b>	DIAVH IPC/PPC series
--------------------------	----------------------

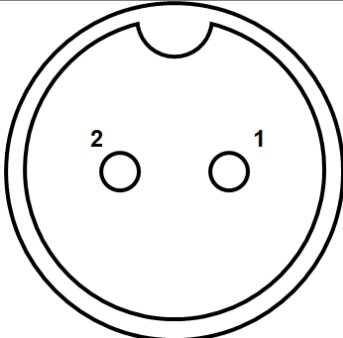
DC12V	Pin	Signal
	1	DC +12V
	2	GND

**MEMO**

---

## Chapter 3 AMI BIOS Utility

### Table of Contents

3.1	Starting BIOS .....	3-2
3.2	Hotkey Shortcuts .....	3-2
3.3	Main Menu .....	3-2
3.4	Advanced Menu .....	3-3
3.5	Chipset Menu .....	3-4
3.6	Security Menu .....	3-4
3.7	Boot Menu .....	3-5
3.8	Save & Exit Menu .....	3-5
3.9	Restore AC Power Loss .....	3-6

### 3.1 Starting BIOS

The AMI UEFI BIOS provides users with a built-in setup program to modify basic system configuration. Start the BIOS setup via the following steps:

1. Turn on the computer and immediately press <F2>
2. After entering the BIOS selection menu, users can access other setups including Advanced and Chipset menus.

It is strongly recommended NOT to change the BIOS default setup parameters, since these defaults are carefully setup by both AMI and the system manufacturer to provide excellent performance and reliability.

### 3.2 Hotkey Shortcuts

The BIOS setup/utility uses hotkeys from the keyboard to access the settings, these keys include <F1>, <F9>, <Enter>, <ESC>, <Arrow> keys and so on.

Hotkey	Description
← → <b>Left/Right</b>	The left and right <Arrow> keys can switch to the BIOS setup page.
↑ ↓ <b>Up/Down</b>	The up and down <Arrow> keys can select sub-items from a BIOS setup page.
+ - <b>Plus/Minus</b>	The plus and minus <Arrow> keys can change the field value of a particular setup item.
<b>Tab</b>	<Tab> key can setup fields.
<b>F1</b>	< F1 > key can display the Help page.
<b>F3</b>	< F3 > key is used in loading the parameter value before the last modification.
<b>F9</b>	< F9 > key is used in loading optimized defaults.
<b>F10</b>	< F10 > key can save any changes and exit the BIOS setup.
<b>Esc</b>	< Esc > key can discard any changes and exit the BIOS setup.
<b>Enter</b>	< Enter > key can display or change specific parameters.

### 3.3 Main Menu

The Main menu displays data including BIOS information, CPU configuration, memory information/ total memory and system time.

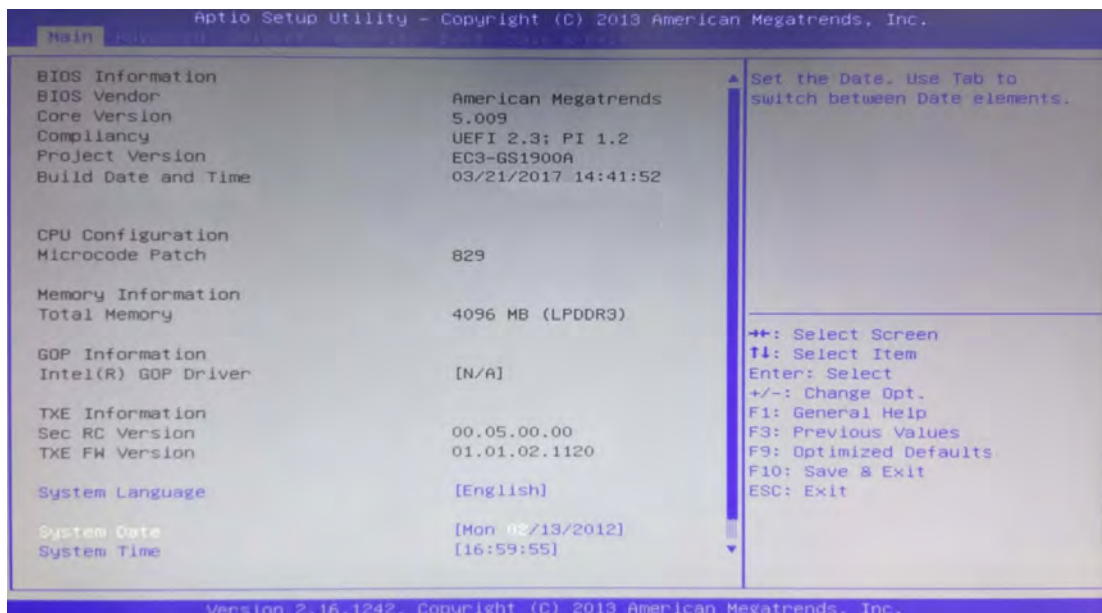

### 3.4 Advanced Menu

The menu provides the host hardware parameter settings for CPU, memory, USB, PCI, MPS configurations.

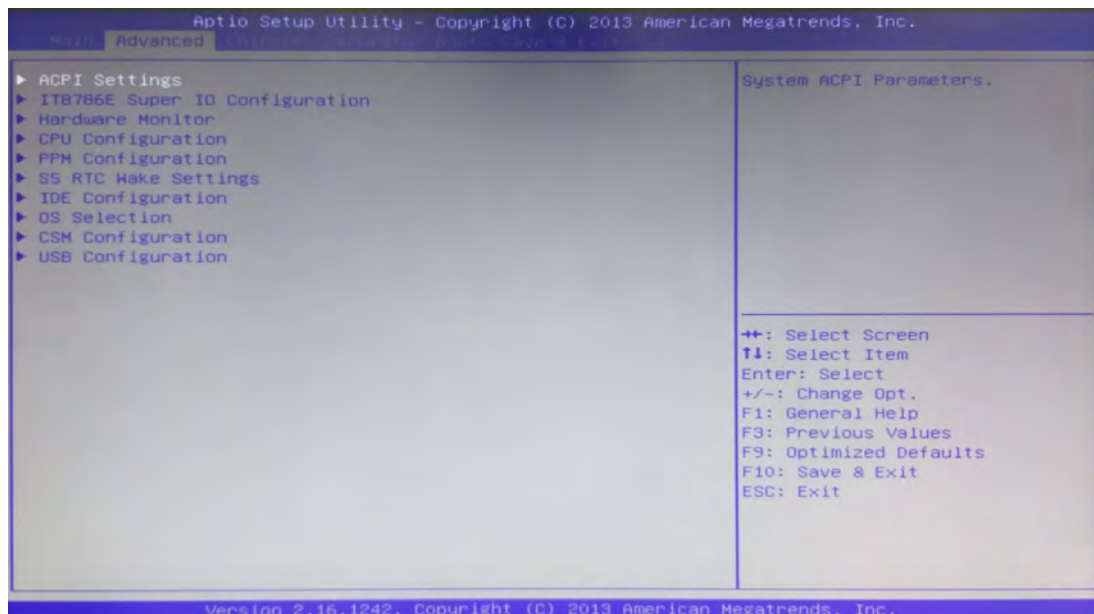

- ACPI Settings
- IT8786E Super IO Configuration
- Hardware Monitor : Include host temperature, voltage monitoring.
- CPU Configuration
- PPM Configuration
- S5 RTC Wake Settings
- IDE Configuration
- OS Selection
- CSM Configuration
- USB Configuration

### 3.5 Chipset Menu

The menu provides hardware setups for south and north bridge chips.

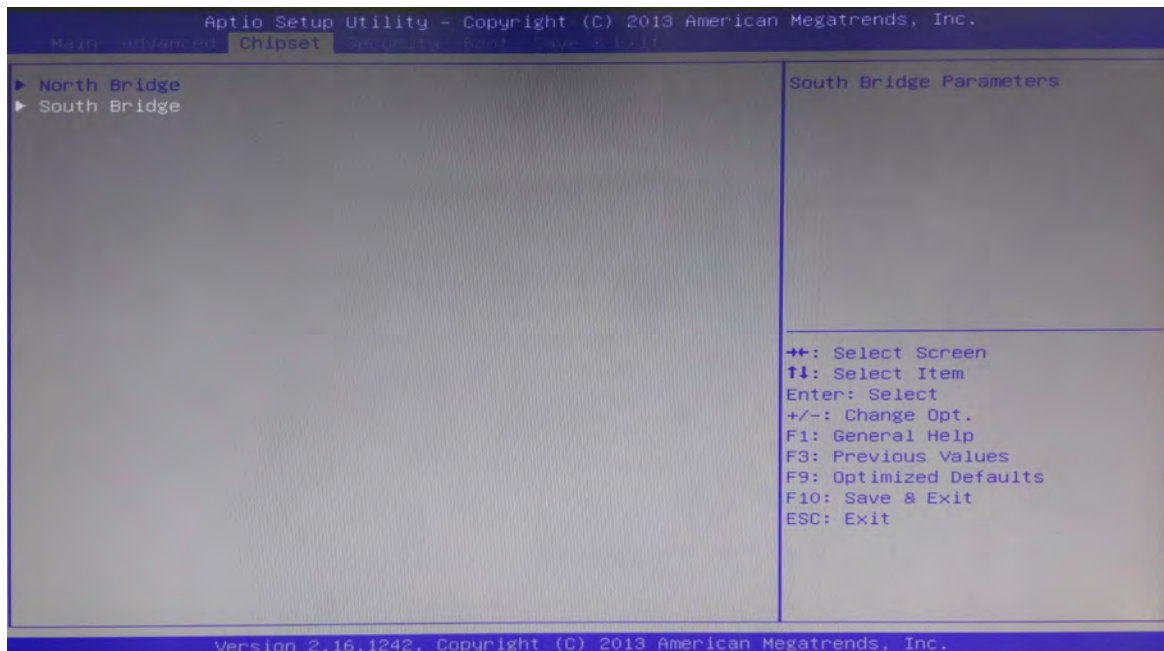

- North Bridge
- South Bridge

### 3.6 Security Menu

The menu provides passwords permitted to access BIOS Setup interface and are used to boot up the computer.

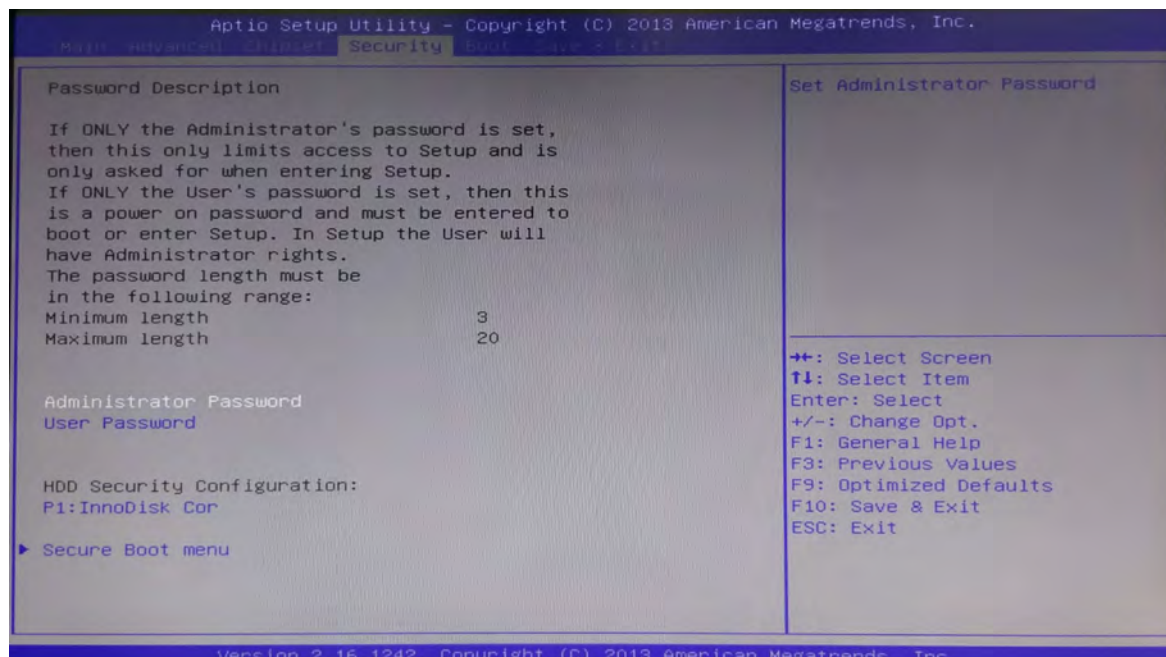

### 3.7 Boot Menu

The menu provides boot configuration and option priorities to setup SSD as the default boot drive; For any changes regarding boot option priorities, choose 'Hard Drive BBS Priorities' shown below.

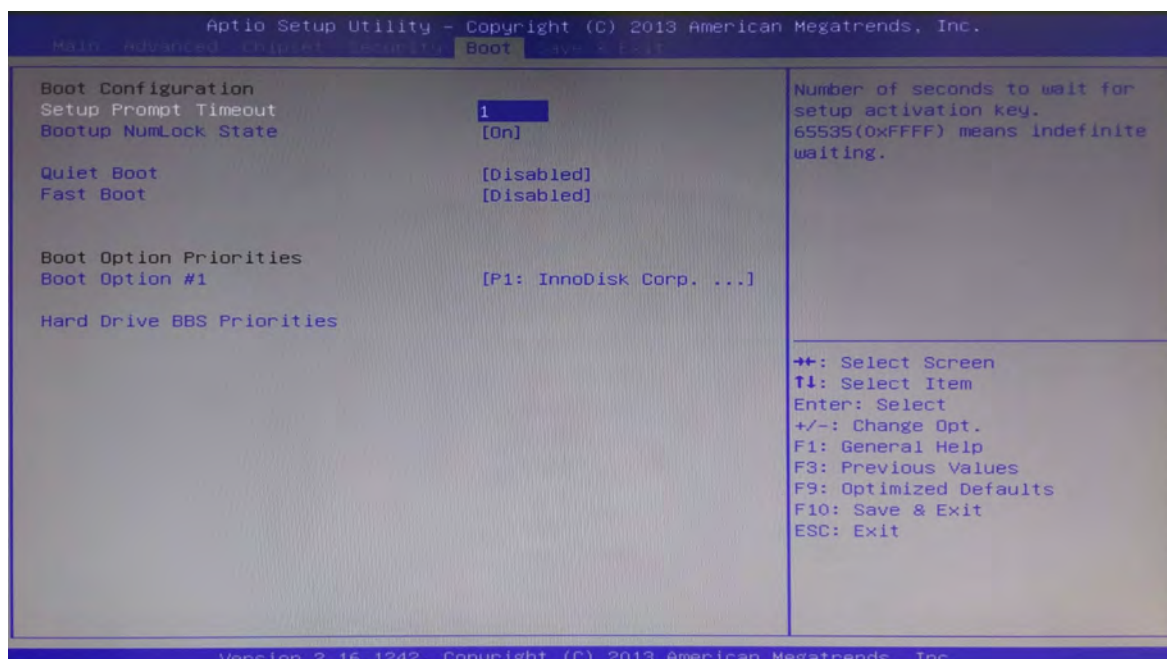

3

### 3.8 Save & Exit Menu

The menu includes reset BIOS parameters and changes that can be made only when needed.

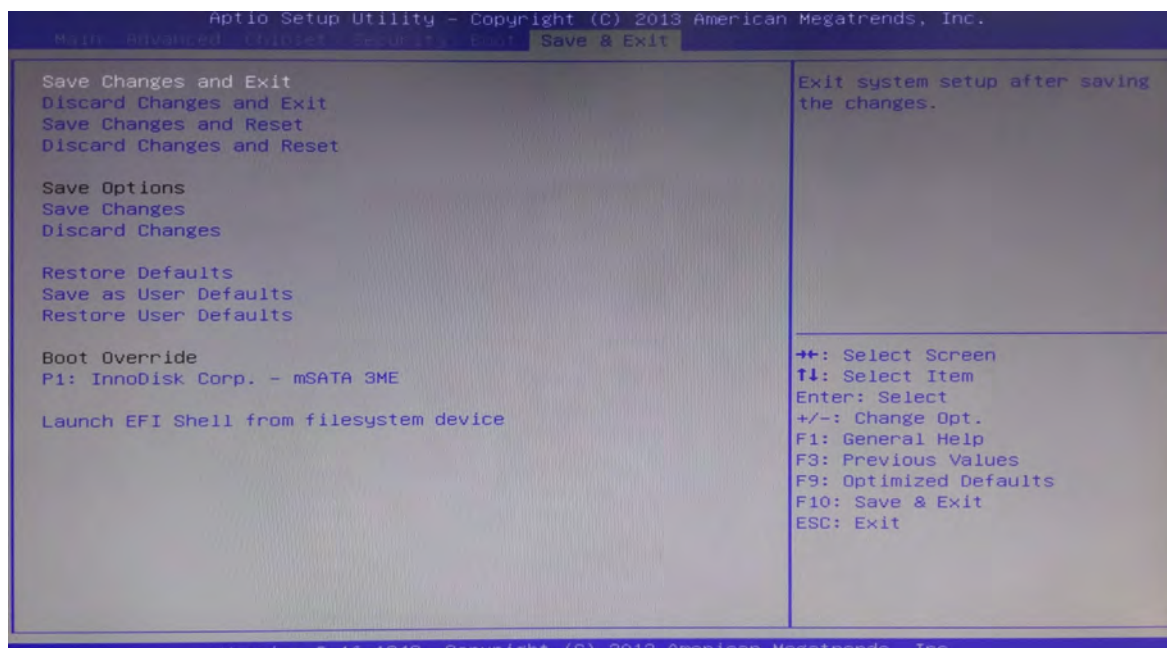



### 3.9 Restore AC Power Loss

Enter the Chipset menu and select South Bridge to setup the Restore AC Power Loss value.

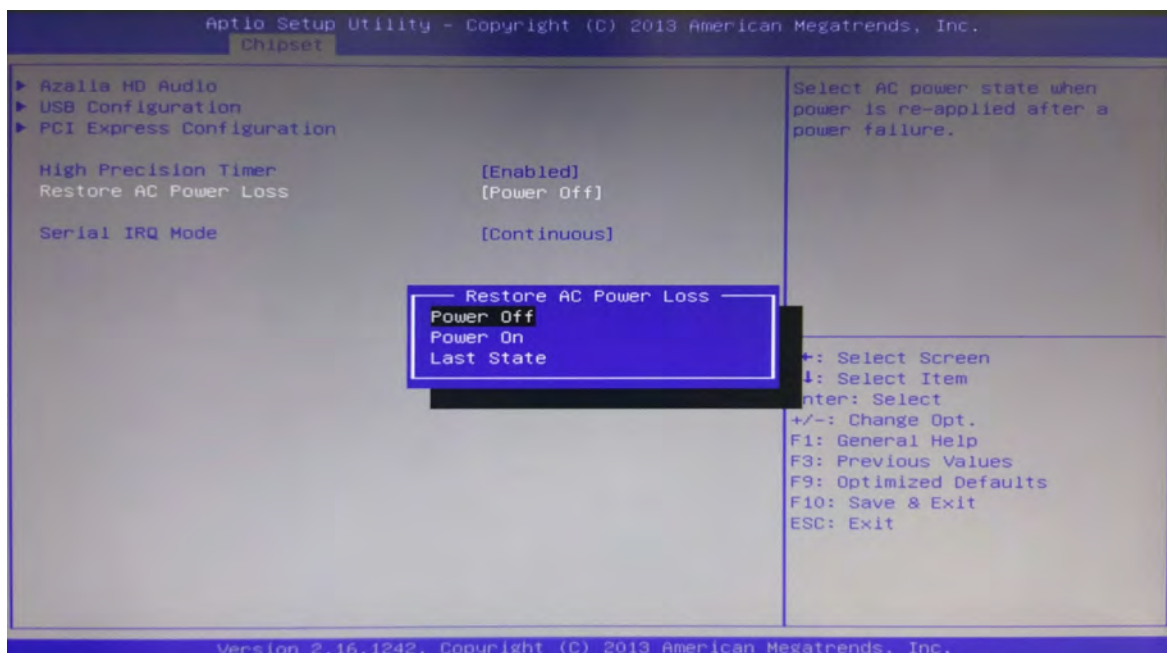
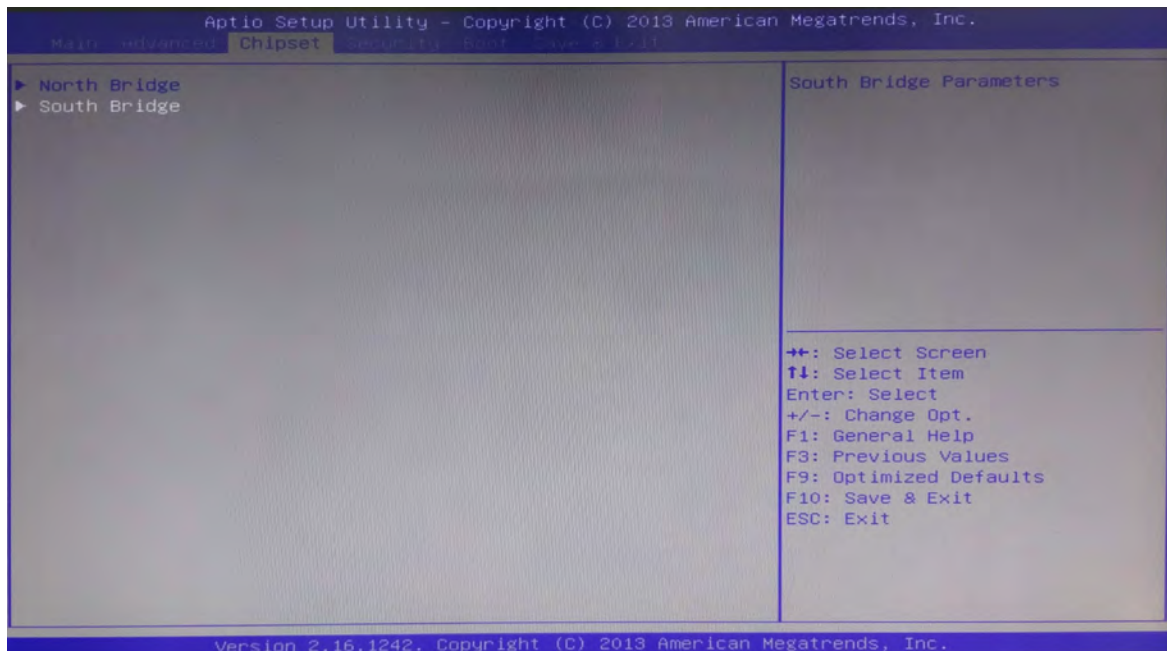

- Power off : Press the host power button to start up the computer.
- Power on : Turns on the computer.
- Last State : Restores to the last state when power is on; if the computer is not properly shut down, it will be turned on when the power is on; if properly shut down, it will be turned off.

---

# Chapter 4 Transportation and Storage Requirements

## Table of Contents

- 4.1 Unpack and Check the Delivery Package ..... 4-2
- 4.2 Transportation ..... 4-2
- 4.3 Storage Requirements ..... 4-2

## 4.1 Unpack and Check the Delivery Package

Please take note of the following when accepting a delivery:

- Do not dispose the original packaging in case you have to reuse it to transport the device again.
- Please keep the enclosed disc drive containing the documentation in a safe place.
- Check the device for any transport damage at the time of delivery.
- Verify the packing list for the completeness of the packaging contents and any accessories.
- If the contents of the packaging are damaged or do not match your order, please contact our customer service.

## 4.2 Transportation

Well-packaged devices are suited for all kinds of transportation. During long-distance transport, pay attention to the following:

- Do not store the device in open cabin or carriage.
- No device is to keep in an outdoor storage during transit.
- Avoid transporting the products together with flammable, explosive and corrosive chemicals.
- Keep the device dry and do not expose to rain, snow or any liquid substances to avoid damage the device.

## 4.3 Storage Requirements

In order to store or keep the products, please take the following precautions:

- Store the product in its original packaging. Please refer to the spec sheet for storage temperature and relative humidity.
- Do not store any harmful gas, flammable, explosive products and corrosive chemicals.
- The device is stored without vibrations, shocks, and strong magnetic interference.
- Keep at least 10cm distance between the packing box and the ground and at least 50cm distance from the wall, heat source, cooling source, window or air inlet.

	<b>CAUTION ! !</b>
	<p>Risk of damage to the device !</p> <p>When transporting the device in cold weather, please pay attention to the extreme changes in temperature. Make sure no water drop (condensation) is build up on the surface or inside the device. If condensation develops, please wait at least 12 hours before switching on the device.</p>



---

# **Appendix A    Touch Screen Usage and Calibration**

## **Table of Contents**

<b>A.1    Using the Touch Screen .....</b>	<b>A-2</b>
<b>A.2    Four Points Calibration .....</b>	<b>A-2</b>

## A.1 Using the Touch Screen

Before the device is delivered, all PPCs are equipped with installation of the touch screen driver so that users can use the function when the computer is switched on. For re-installation, please view the following steps:

- Left-click the mouse: Touch the screen once.
- Double left-click the mouse: Touch the screen twice.
- Right-click the mouse: Touch the screen and wait 1 sec.

## A.2 Four Points Calibration

1. Click 'eGalaxTouch' from the desktop and activate the touch screen software.

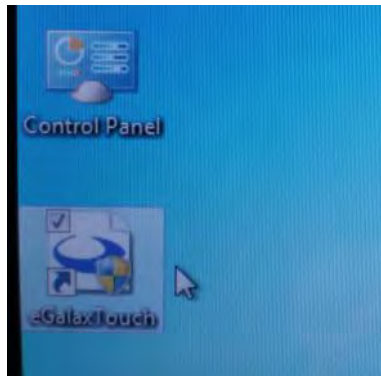

2. Select 'Tools' page.

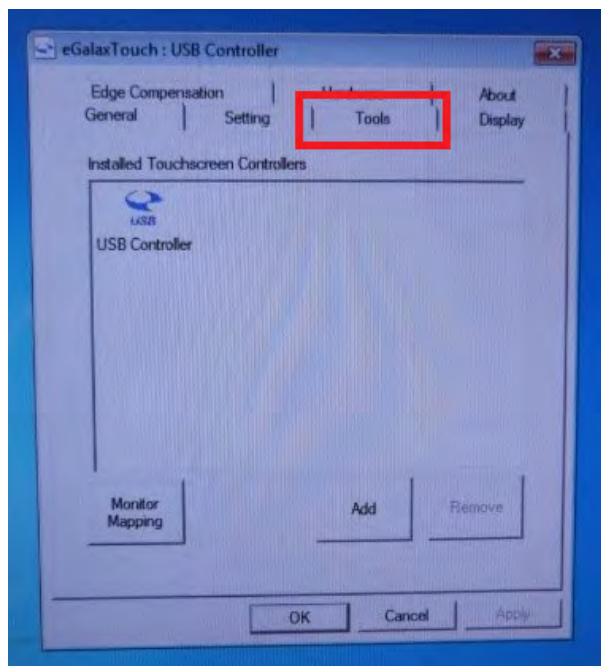

3. Select **'4 Points Calibration'** to enter the page.

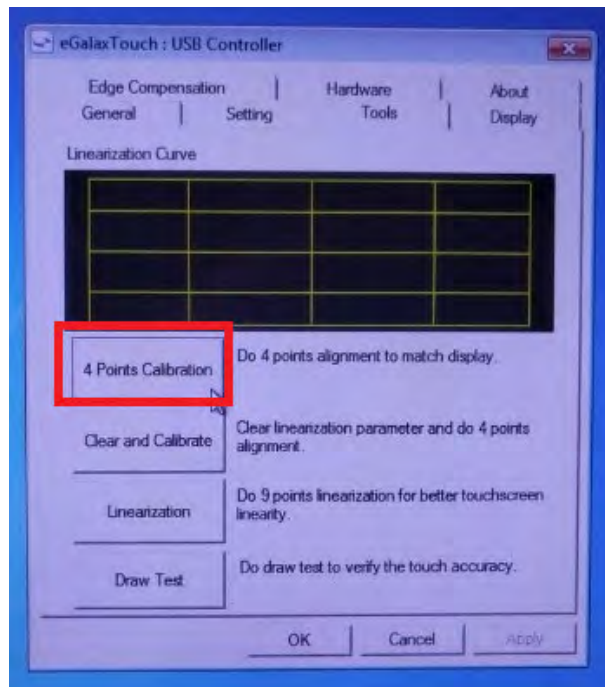

4. Click the four corners on the screen (see below) to complete the 4 points calibration.



A

