



DVPPF02-SL

PROFIBUS DP Slave Communication Module

Operation Manual



<http://www.delta.com.tw/industrialautomation>



Warning

- ✓ This operation manual provides introduction on the functions, specifications, installation, basic operation, settings and network protocol for DVPPF02-SL.
- ✓ This is an OPEN TYPE device and therefore should be installed in an enclosure free of airborne dust, humidity, electric shock and vibration. The enclosure should prevent non-maintenance staff from operating the device (e.g. key or specific tools are required to open the enclosure) in case danger and damage on the device may occur. DO NOT touch any terminal when the power is switched on.
- ✓ Please read this operation manual thoroughly and follow the instructions in case damages on the device or injuries on the operation staff occur.



Table of Content

1	Introduction to DVPPF02-SL	2
1.1	Features	2
2	Product Profile and Outline	2
3	Installation	4
3.1	Dimensions.....	4
3.2	Connecting DVPPF02-SL to PLC MPU.....	4
3.3	Installing DVPPF02-SL and PLC MPU on DIN Rail	4
3.4	PIN Definition for PROFIBUS DP Port	5
3.5	Connecting to PROFIBUS DP Port	5
3.6	Address Switch.....	5
4	Establishing PROFIBUS DP Network by DVPPF02-SL	6
5	Transmission Distance and Baudrate	6
6	GSD File	7
7	Mapping Areas and Status Registers	7
8	Configuring DVPPF02-SL	8
8.1	Configuring DVPPF02-SL	8
8.2	I/O Configuration for DVPPF02-SL	8
9	LED Indicators and Trouble-shooting	9
10	Application Example	10

1 Introduction to DVPPF02-SL

1. Thank you for choosing Delta DVPPF02-SL PROFIBUS DP slave communication module. To ensure correct installation and operation of the product, please read this operation manual carefully before using it.
2. This operation manual only provides introductory information on DVPPF02-SL. For more detailed information on the PROFIBUS DP protocol, please refer to relevant references or literatures.
3. DVPPF02-SL is a PROFIBUS DP slave communication module, used for connecting the Delta DVP-SV and DVP-SX2 series PLC to the PROFIBUS DP network. DVPPF02-SL is a left-side extension module, and no external power supply is required when using it. The power is supplied by the PLC MPU (main processing unit).

1.1 Features

- Supports the loop data transmission between the PROFIBUS DP master and many slaves.
- Auto-detects baudrate; supports max. 12M bps.
- Self-diagnosis
- A PLC MPU is extendable to max. 8 modules on its left hand side.
- Supports max. 100 words of I/O output and 100 words of I/O input.

2 Product Profile and Outline

2.1 Product Profiles

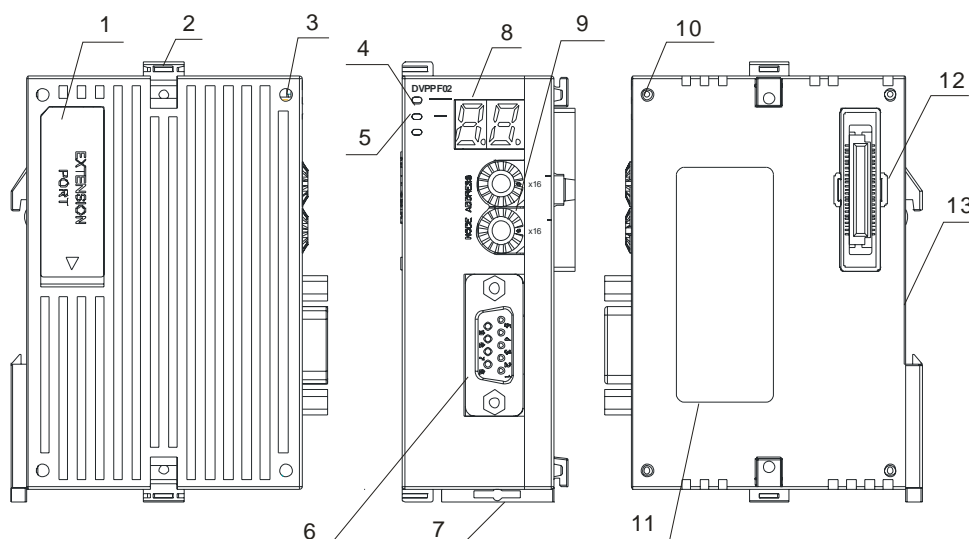

1	Interface for left-side I/O module	2	I/O module fastening clip	3	I/O module positioning hole
4	POWER indicator	5	NET indicator	6	PROFIBUS DP port
7	DIN rail clip	8	Digital display	9	Address switch
10	Positioning clip	11	Nameplate	12	I/O module interface
13	DIN rail (35mm)				

2.2 Specifications

PROFIBUS DP Port

Interface	DB9 connector
Transmission method	High-speed RS-485
Transmission cable	Shielded twisted pair cable
Electrical isolation	500 VDC

Communication

Data type	Cyclic data exchange
Module name	DVPPF02-SL
GSD document	DELA0AFE.GSD
Product ID	0AFE
Serial baudrate supported (auto-detection)	9.6k, 19.2k, 93.75k, 187.5k, 500k, 1.5M, 3M, 6M, 12M bps (bits/second)

Electrical Specification

Power supply voltage	24 VDC
Insulation voltage	500 VDC
Power consumption	2 W
Weight	115 g

Environment

Interference immunity	ESD (IEC 61800-5-1, IEC 6100-4-2) EFT (IEC 61800-5-1, IEC 6100-4-4) Surge Teat (IEC 61800-5-1, IEC 6100-4-5) Conducted Susceptibility Test (IEC 61800-5-1, IEC 6100-4-6)
Storage/operation	Operation: -10 to 50°C (temperature), 90% (humidity) Storage: -25 to 70°C (temperature), 95% (humidity)
Shock/vibration immunity	International standards: IEC 61800-5-1, IEC 60068-2-6/IEC 61800-5-1, IEC 60068-2-27

3 Installation

3.1 Dimensions

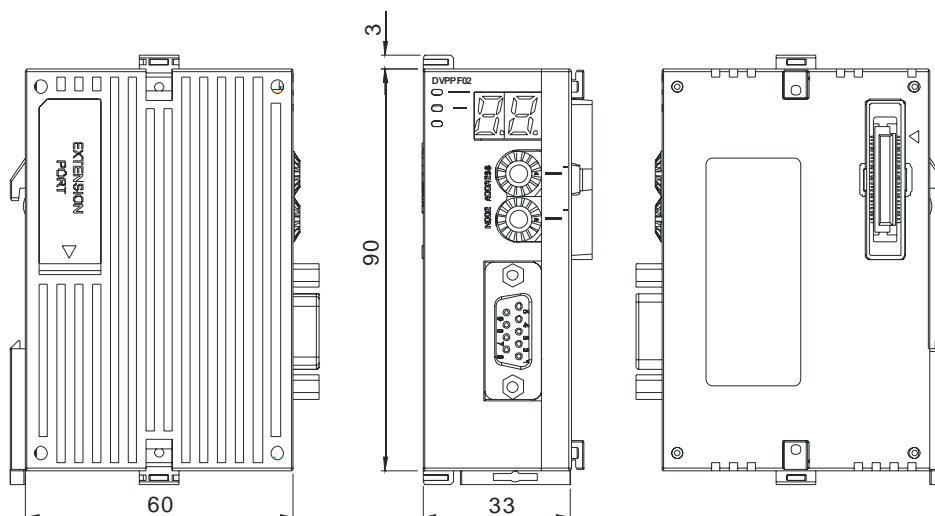

Unit: mm

3.2 Connecting DVPPF02-SL to PLC MPU

- Open the fastening ports for the I/O module on the left hand side of the PLC MPU and insert the DVPPF02-SL alongside the fastening clips, as ①.
- Press the clips to make sure the connection is tight, as ②.

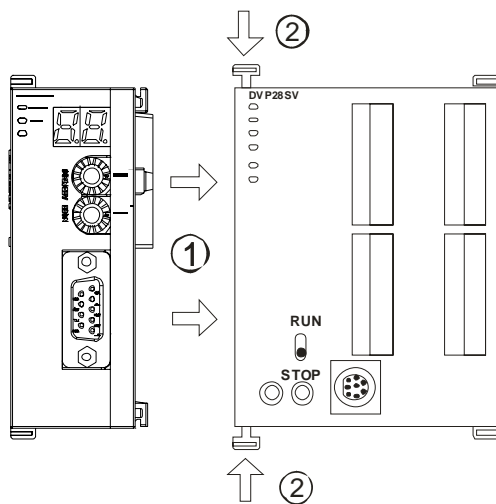

3.3 Installing DVPPF02-SL and PLC MPU on DIN Rail

- Use 35mm DIN rail.
- Open the DIN rail clips on DVPPF02-SL and the PLC MPU. Insert DVPPF02-SL and the PLC MPU onto the DIN rail.
- Clip up the DIN rail clip on DVPPF02-SL and the PLC MPU to fix them on the DIN rail.

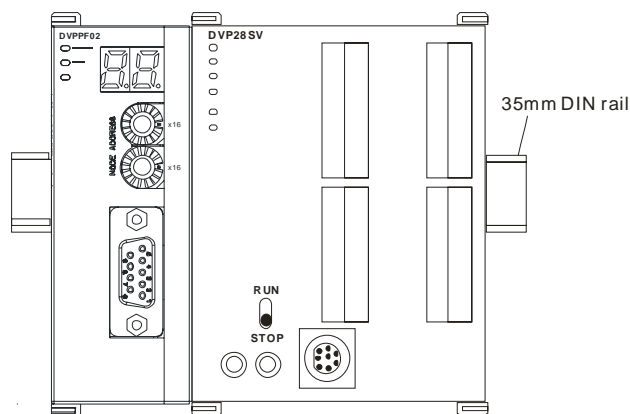

3.4 PIN Definition for PROFIBUS DP Port

PIN	Name	Definition
1	--	N/C
2	--	N/C
3	RxD/TxD-P	Sending/receiving data P (B)
4	--	N/C
5	DGND	Data reference potential (C)
6	VP	Power voltage - positive
7	--	N/C
8	RxD/TxD-N	Sending/receiving data N (A)
9	--	N/C

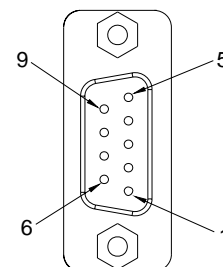

3.5 Connecting to PROFIBUS DP Port

Insert the PROFIBUS DP bus connector into the PROFIBUS DP port on DVPPF02-SL. Screw it tight to ensure DVPPF02-SL and the PROFIBUS DP bus are properly connected.

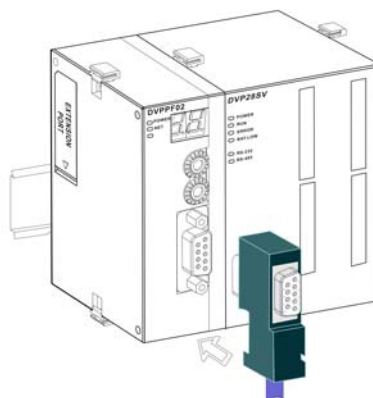

3.6 Address Switch

The address switches on DVPPF02-SL are used for setting up the node address of DVPPF02-SL on the PROFIBUS DP network. The switches are two rotary switches x16⁰ and x16¹. Range for each switch: 0 ~ F. See the table below for the setup range for the switches.

Address	Definition
H'1 ~ H'7D	Valid PROFIBUS address
H'0 or H'7E ~ H'FF	Invalid PROFIBUS address

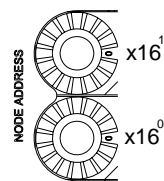

Example: If you are to set the node address of DVPPF02-SL to 26 (decimal), simply switch x16¹ to 1 and x16⁰ to A. 26 (decimal) = 1A (hex) = 1×16¹ + A×16⁰.

Notes:

- Set up the address of DVPPF02-SL when the power is off. Re-power the module after you finish setting the address.
- Changing the setting of address when DVPPF02-SL is operating is regarded invalid.
- Use slotted screwdriver carefully to adjust the address in case you scrape the module.

4 Establishing PROFIBUS DP Network by DVPPF02-SL

DVPPF02-SL is used for connecting the DVP-SV and DVP-SX2 series PLC to the PROFIBUS DP network.

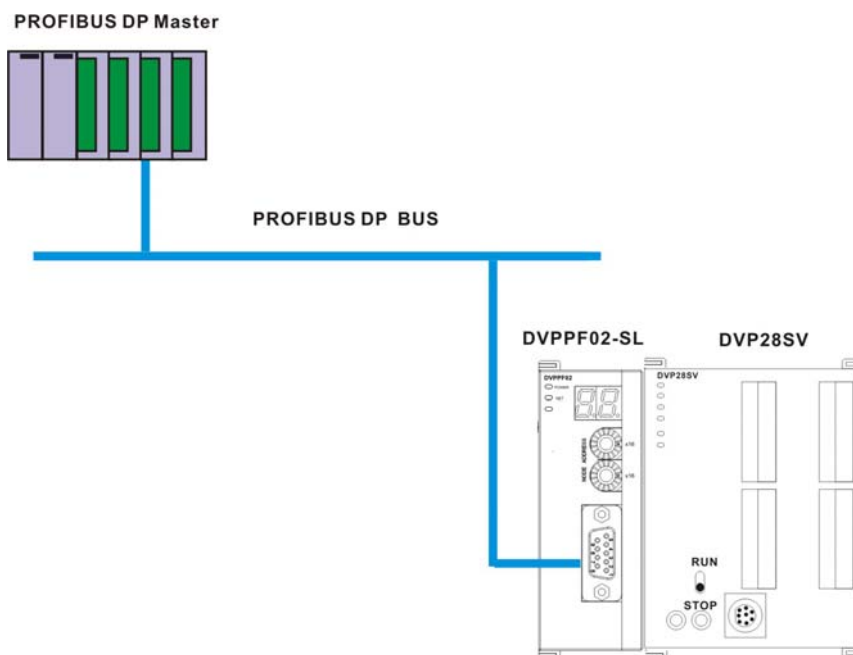

5 Transmission Distance and Baudrate

The baudrate for PROFIBUS DP communication ranges from 9.6k to 12M bits per second (bps). The length of cable is determined by the transmission speed. The transmission distance can be from 100 to 1,200 meters. See the table below for the baudrates DVPPF02-SL support and their corresponding transmission distance.

Baudrate (bps)	9.6k	19.2k	93.75k	187.5k	500k	1.5M	3M	6M	12M
Distance (m)	1,200	1,200	1,200	1,000	400	200	100	100	100

6 GSD File

GSD file is a text file, used for identify the PROFIBUS DP device (master or slave). A GSD file includes data required for configuring a slave on the PROFIBUS DP master, information on the supplier, baudrates supported and applicable I/O. When using DVPPF02-SL, first import the GSD file to the software for configuring the PROFIBUS DP master, then DVPPF02-SL and items to be configured will be displayed in the software. You can download the GSD file for DVPPF02-SL from Delta's website:

<http://www.delta.com.tw/>

7 Mapping Areas and Status Registers

The PLC MPU is extendable to 8 DVPPF02-SL modules on its left hand side. The first module is at location 1. See the table below for the I/O mapping and status registers of DVPPF02-SL at different locations.

Direction Location	Output mapping Slave → Master	Input mapping Master → Slave	Status register
1	D6250 ~ D6349	D6000 ~ D6099	D6100
2	D6750 ~ D6849	D6500 ~ D6599	D6600
3	D7250 ~ D7349	D7000 ~ D7099	D7100
4	D7750 ~ D7849	D7500 ~ D7599	D7600
5	D8250 ~ D8349	D8000 ~ D8099	D8100
6	D8750 ~ D8849	D8500 ~ D8599	D8600
7	D9250 ~ D9349	D9000 ~ D9099	D9100
8	D9750 ~ D9849	D9500 ~ D9599	D9600

Explanations on status registers for DVPPF02-SL:

High byte		Low byte	
Code	Definition	Code	Definition
0	Normal status	0	No error
1	Initializing	F1	DVPPF02-SL is initializing.
2	Error	F0	The node address of DVPPF02-SL is out of range.
		F2	Error in low voltage detection
		F3	DVPPF02-SL enters factory test mode.
		F4	DVPPF02-SL is disconnected from the master.
		F5	Error in parameter

High byte		Low byte	
Code	Definition	Code	Definition
2	Error	F7	Hardware error
		F9	Configuration error

8 Configuring DVPPF02-SL

8.1 Configuring DVPPF02-SL

When you configure DVPPF02-SL in the software for PROFIBUS DP master and DVPPF02-SL is offline from the PROFIBUS DP master, you can select to “clear I/O data” or “hold I/O data”, as shown below.

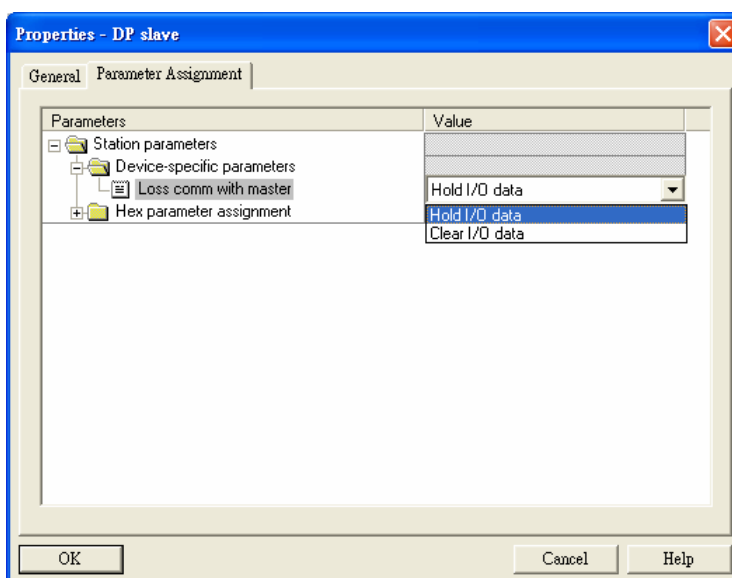

Figure 8.1-1

Parameter	Value	Definition
Los comm. with master	Hold I/O data	After DVPPF02-SL goes offline from the master, the I/O data will remain the same as they were before being offline.
	Clear I/O data	After DVPPF02-SL goes offline from the master, the output data will be reset to 0 and input data remain the same.

8.2 I/O Configuration for DVPPF02-SL

When DVPPF02-SL is configured in the software for the PROFIBUS DP master, it offers many choices for configuration, satisfying all kinds of data length demands. See the table below. The output configuration means the data is sent from the master to the slave; the input configuration means from the slave to the master.

Output configuration	Input configuration	I/O configuration
1 word out	1 word out	1 word out 1 word in
2 words out	2 words out	2 words out 1 word in
4 words out	4 words out	4 words out 1 word in
8 words out	8 words out	8 words out 1 word in
16 words out	16 words out	16 words out 1 word in
32 words out	32 words out	32 words out 1 word in
64 words out	64 words out	64 words out 1 word in

9 LED Indicators and Trouble-shooting

- POWER LED

The POWER LED displays the status of the power supply for DVPPF02-SL.

LED status	Indication	How to correct
Green light on	The power supply is normal.	--
Off	No power supply	<ol style="list-style-type: none"> 1. Check if the connection between DVPPF02-SL and the PLC MPU is normal. 2. Check if the power supply from the PLC MPU is normal.

- NET LED

The NET LED displays the communication status between DVPPF02-SL and the PROFIBUS DP master.

LED status	Indication	How to correct
Green light on	A connection is established between the master and slave.	--
Red light on	DVPPF02-SL has not established a connection with the master.	<ol style="list-style-type: none"> 1. Check if DVPPF02-SL is connected with the PROFIBUS DP bus. 2. Check if the communication cable between DVPPF02-SL and the PROFIBUS DP master is well connected. 3. Check if the actual address of DVPPF02-SL is consistent with the address configured in the software. 4. Check if the GSD file is used correctly.

- Digital Display

The digital display shows the status of DVPPF02-SL.

Code	Indication	How to correct
1 ~ 7D	The node address of DVPPF02-SL when it is operating normally.	--
F0	The node address of DVPPF02-SL is out of range.	Set the node address of DVPPF02-SL to be 1 to 125.

Code	Indication	How to correct
F1	DVPPF02-SL is initializing.	--
F2	Error in low voltage detection	1. Check if the connection between DVPPF02-SL and the PLC MPU is normal. 2. Check if the power supply from the PLC MPU is normal.
F3	DVPPF02-SL enters factory test mode.	Write 0 into D6350 in the PLC MPU.
F4	DVPPF02-SL is disconnected from the master.	Check if the communication cable between DVPPF02-SL and the PROFIBUS DP master is well connected.
F5	Error in parameter	Check if the GSD file is used correctly.
F7	Hardware error	Send the module back to factory for repair.
F9	Configuration error	Check if the GSD file is used correctly.
80	The PLC MPU connected to DVPPF02-SL is in STOP status.	Switch the PLC MPU to RUN.

Operation of Digital Display

1. When DVPPF02-SL is in normal operation status and the PLC MPU is in RUN status, the digital display will only show its node address.
2. When DVPPF02-SL is in normal operation status and the PLC MPU is in STOP status, the digital display will show its node address and the STOP status code alternately.
3. When DVPPF02-SL is initializing or in error status and the PLC MPU is in RUN status, the digital display will show its node address, initialization code or error code alternately.
4. When DVPPF02-SL is initializing or in error status and the PLC MPU is in STOP status, the digital display will show its node address, initialization or error code and STOP status code alternately.

10 Application Example

Application:

A data exchange between Siemens S7-300 PLC and DVPPF02-SL through the PROFIBUS DP network

Connecting DVPPF02-SL to the PROFIBUS DP Network:

1. The Siemens S7-300 PLC is the PROFIBUS DP master and DVPPF02-SL the slave. See Figure 10-1 for the network structure.

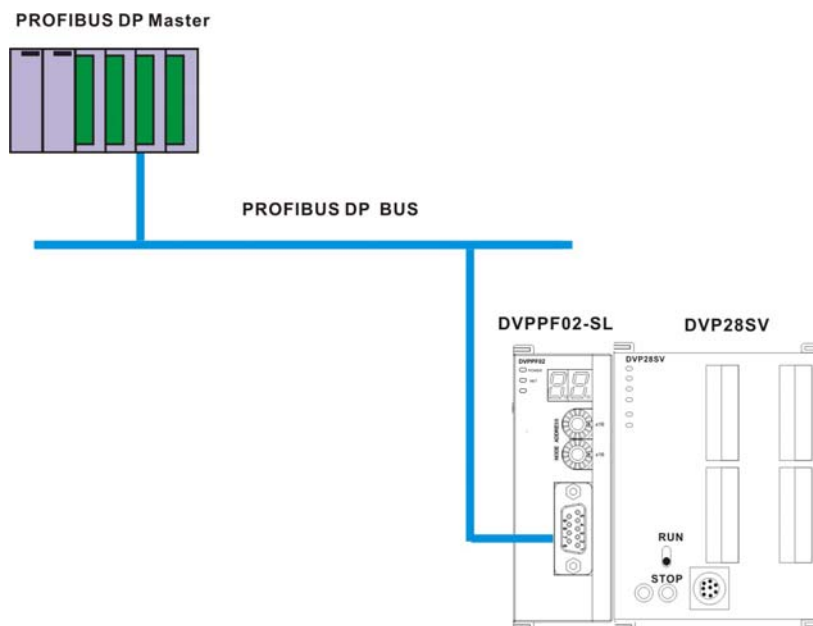

Figure 10-1

2. Set the PROFIBUS address of DVPPF02-SL to "1".
3. Connect a DVP-SV PLC on the right side of DVPPF02-SL and check if the connection is proper.

Configuring DVPPF02-SL on the PROFIBUS DP Network by Software:

- Creating a new project using the software wizard
1. Open the software SIMATIC Manager, as Figure 10-2.

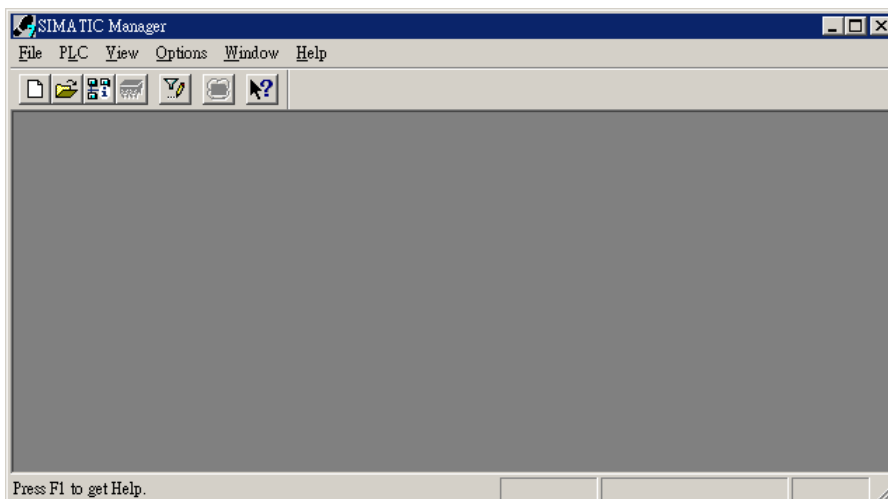

Figure 10-2

2. Select "File" => "New Project Wizard", as Figure 10-3.

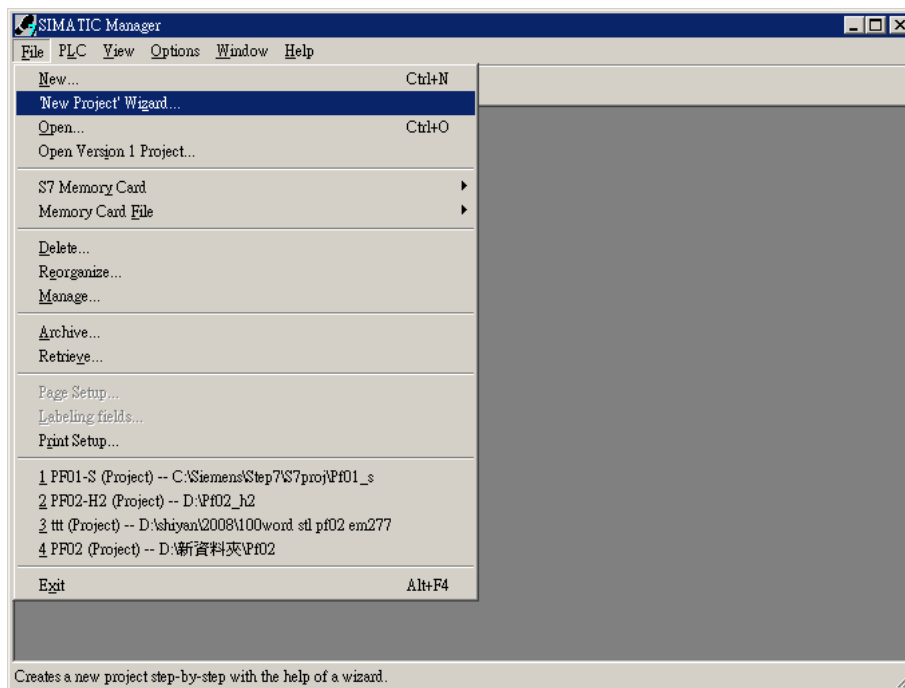

Figure 10-3

3. Click “Next” in the wizard, as Figure 10-4.

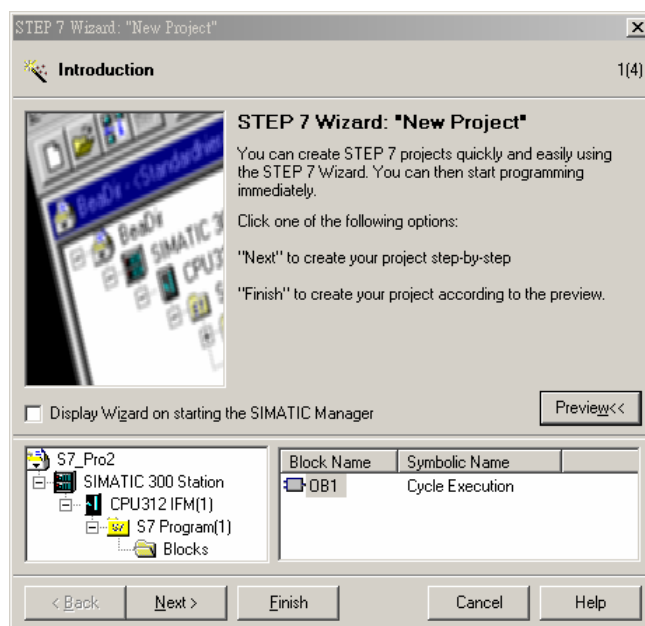

Figure 10-4

4. Select a CPU type for the S7-300 model we are using and click “Next”, as Figure 10-5.

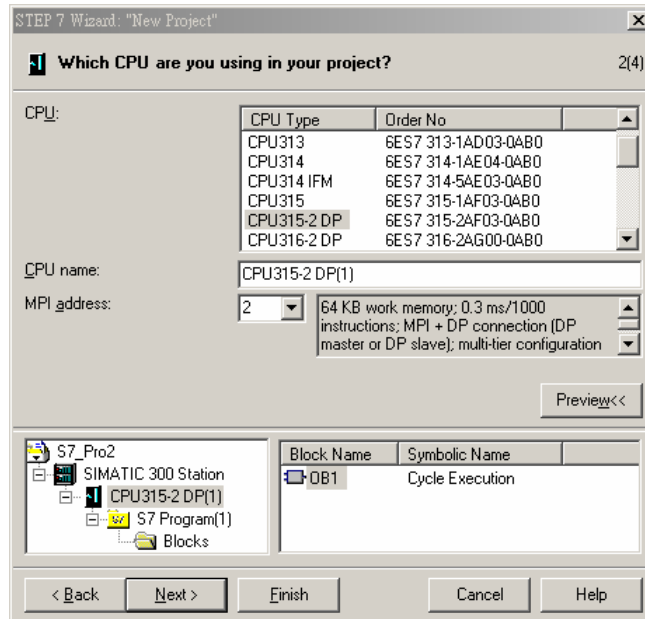

Figure 10-5

5. Select a language for selected blocks and click "Next", as Figure 10-6.

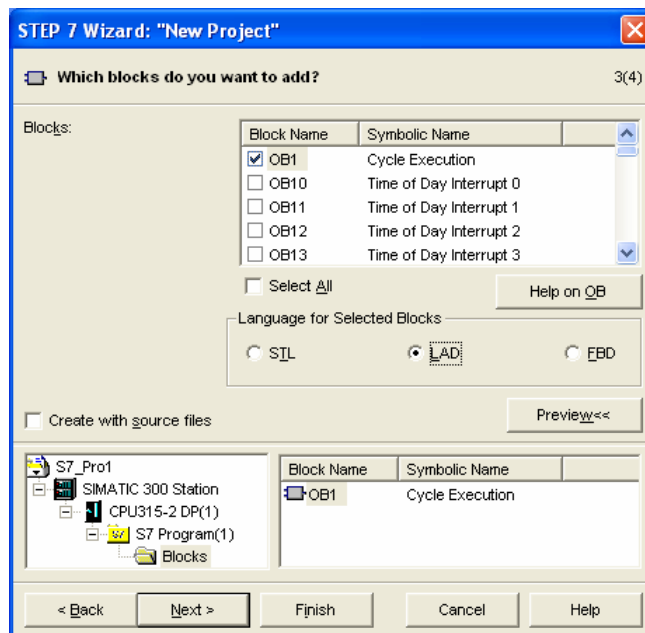

Figure 10-6

6. Enter the project name and click "Finish", as Figure 10-7.

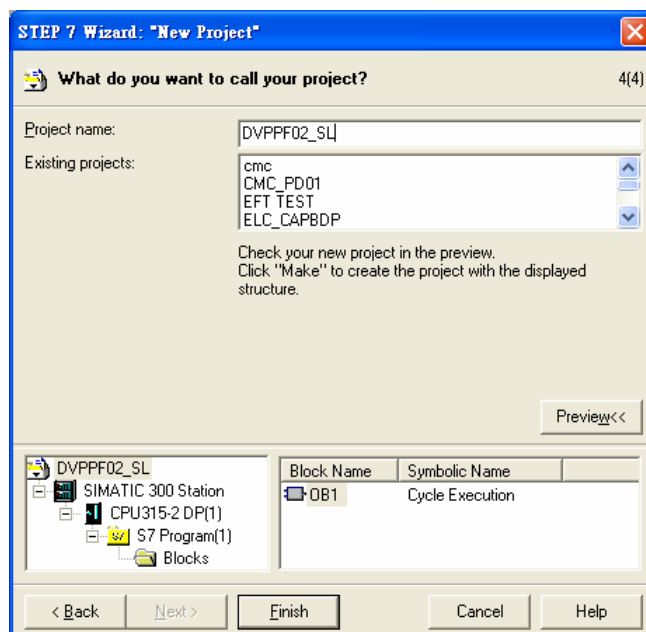

Figure 10-7

7. A new window for the newly created project then appears, as Figure 10-8.

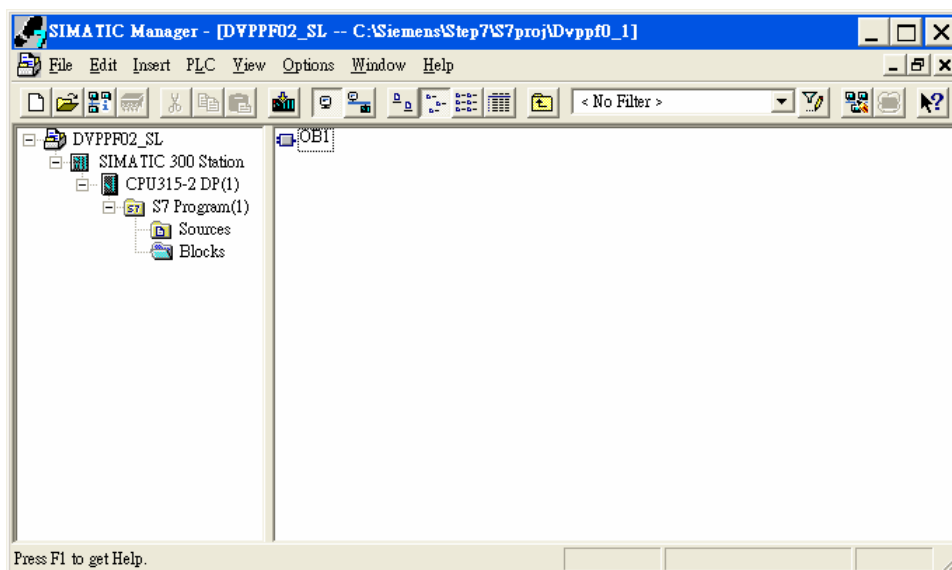

Figure 10-8

- Adding PROFIBUS DP bus
 1. Select "SIMATIC 300 Station" in the new project window and double click "Hardware" in the right-hand side window. A new window "HW-Config" will then appear.

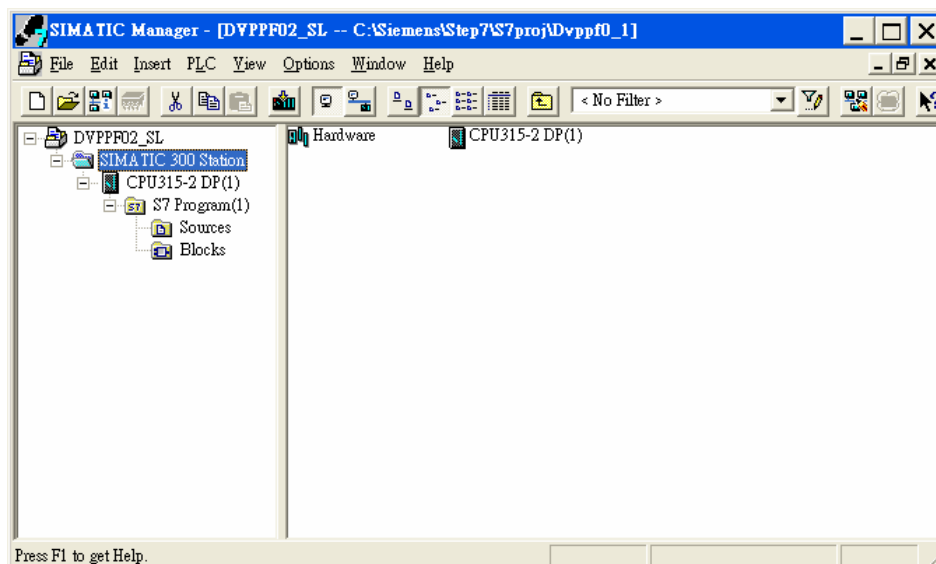

Figure 10-9

2. In the HW Config window, double click “DP” in the (0)UR window, as Figure 10-10, and a new dialog box will appear.

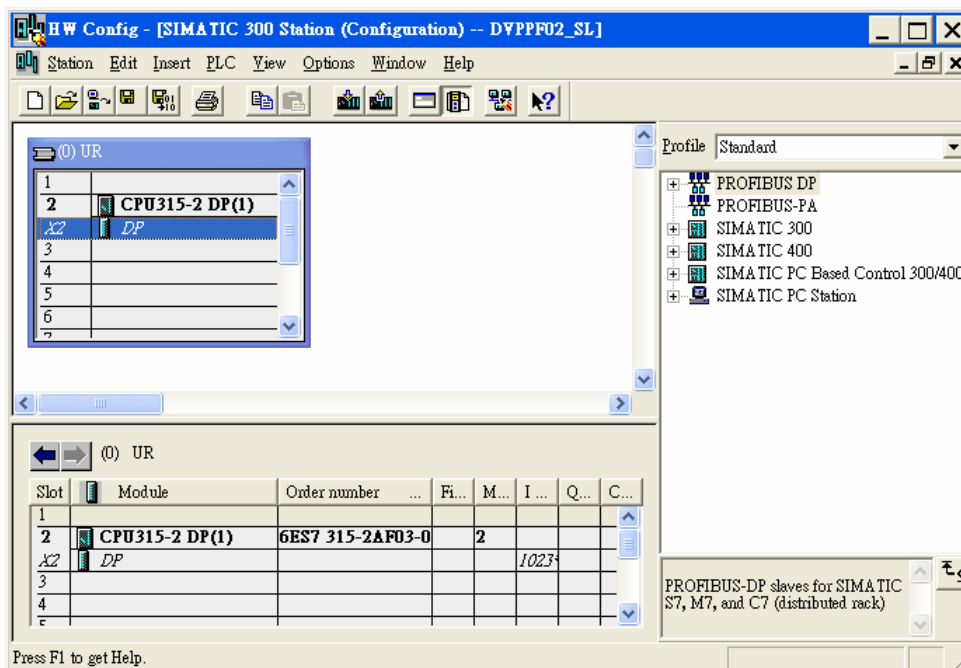

Figure 10-10

3. In the new dialog box, click “Properties” to open another dialog box, as Figure 10-11.

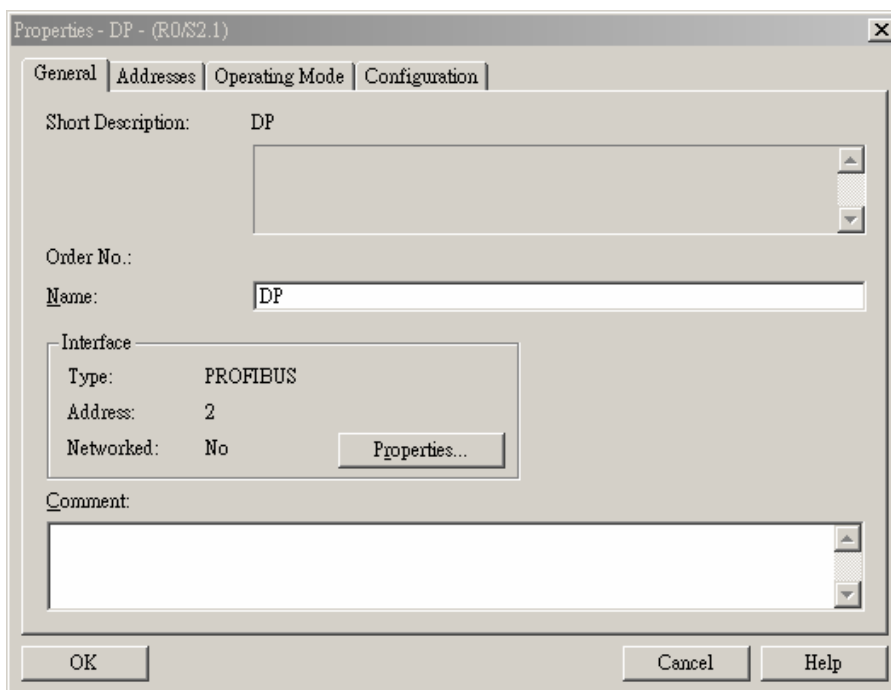

Figure 10-11

4. In this dialog box, select an address for the master and click “New” to open another dialog box, as Figure 10-12.

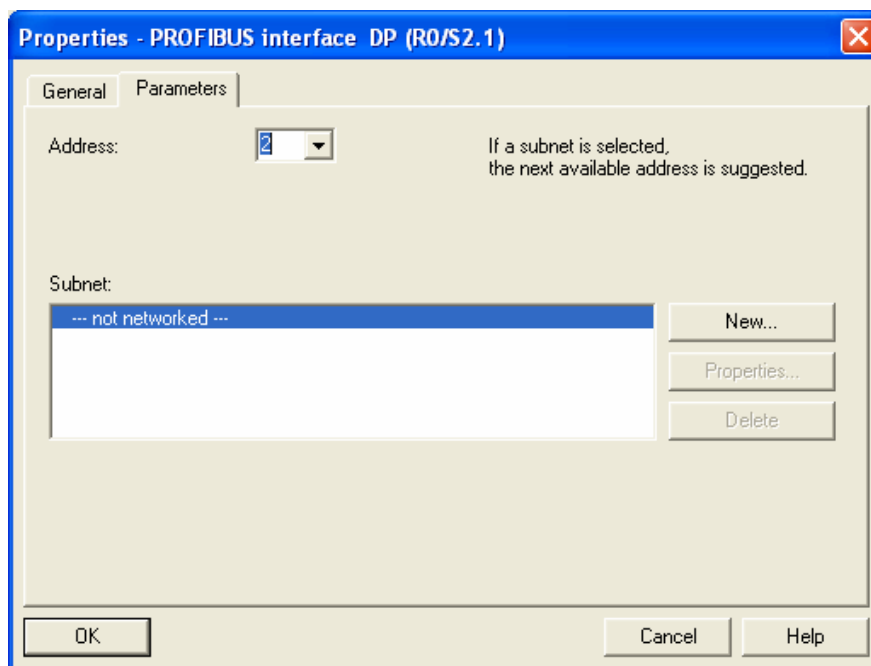

Figure 10-12

5. In this dialog box, select transmission rate and profile for the bus and click “OK”, as Figure 10-13.

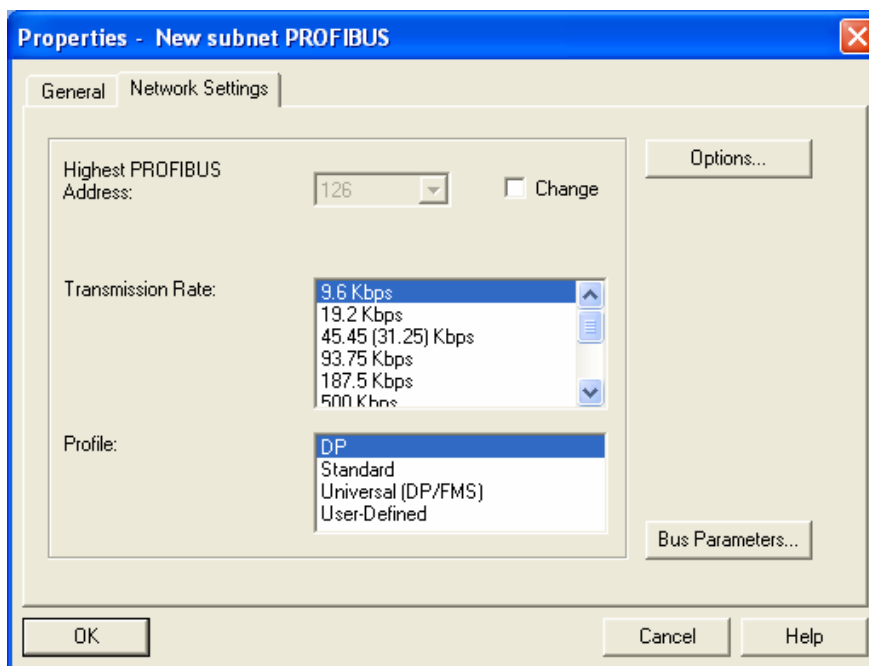

Figure 10-13

6. In this successive dialog box, confirm the address and transmission rate of the PROFIBUS DP bus and click "OK".

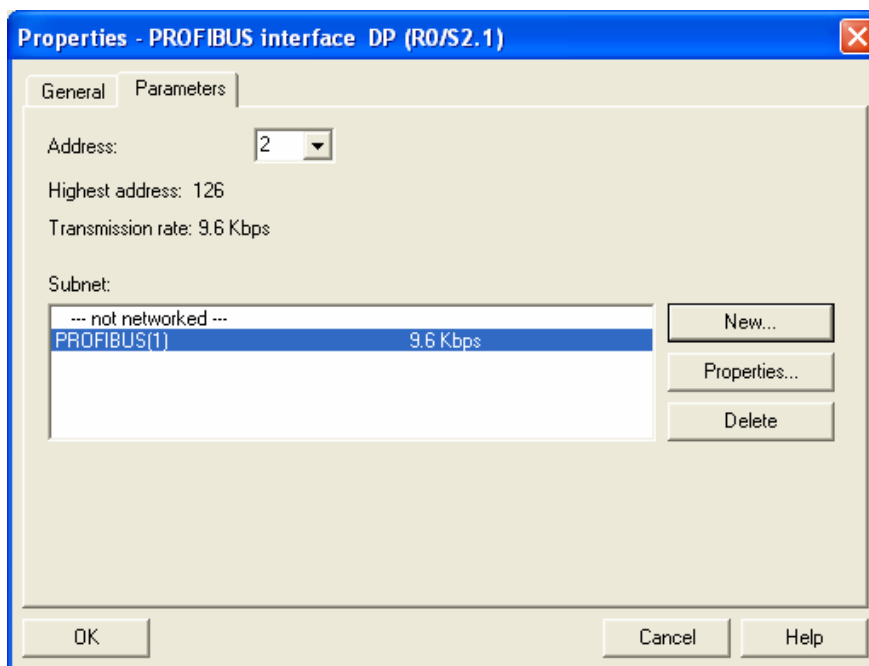

Figure 10-14

7. In this successive dialog box, confirm all information for the DP bus and click "OK", as Figure 10-15.

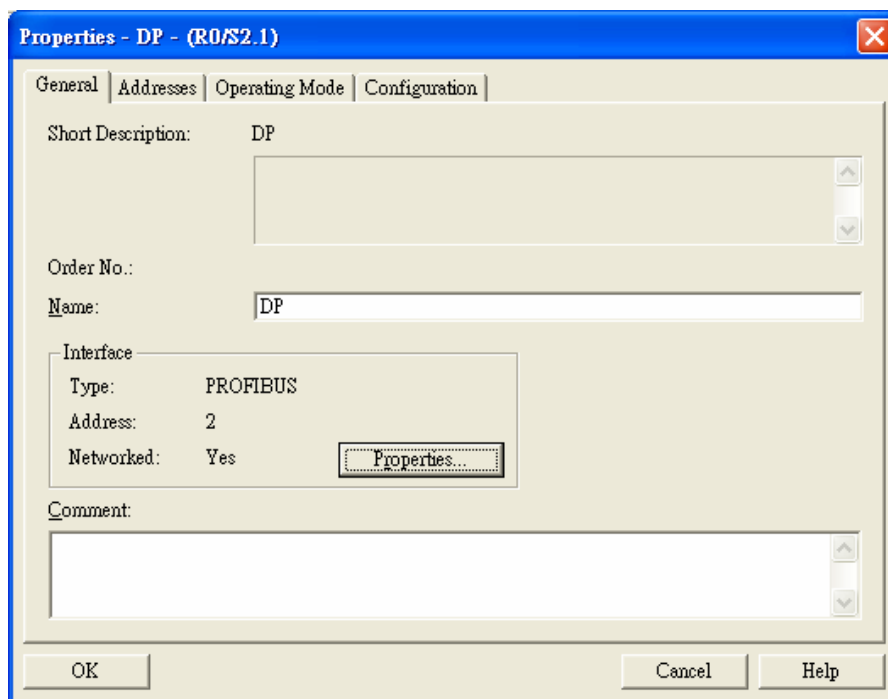

Figure 10-15

8. After all the parameters are set, a PROFIBUS DP bus will be created after the UR window, as Figure 10-16.

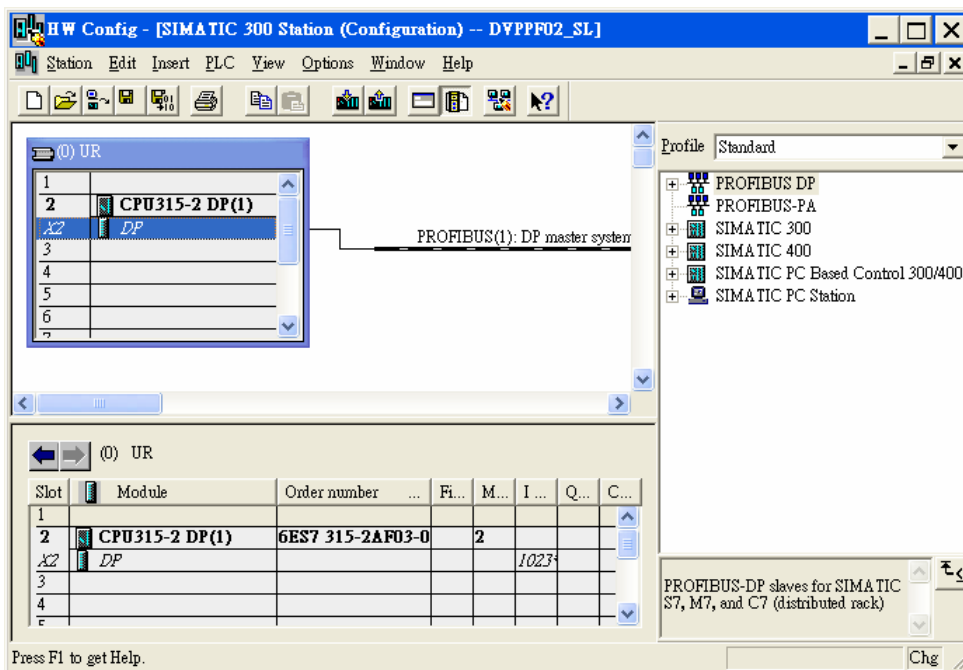

Figure 10-16

- Adding GSD file

1. In the HW Config window, select "Options" => "Install GSD File", as Figure 10-17.

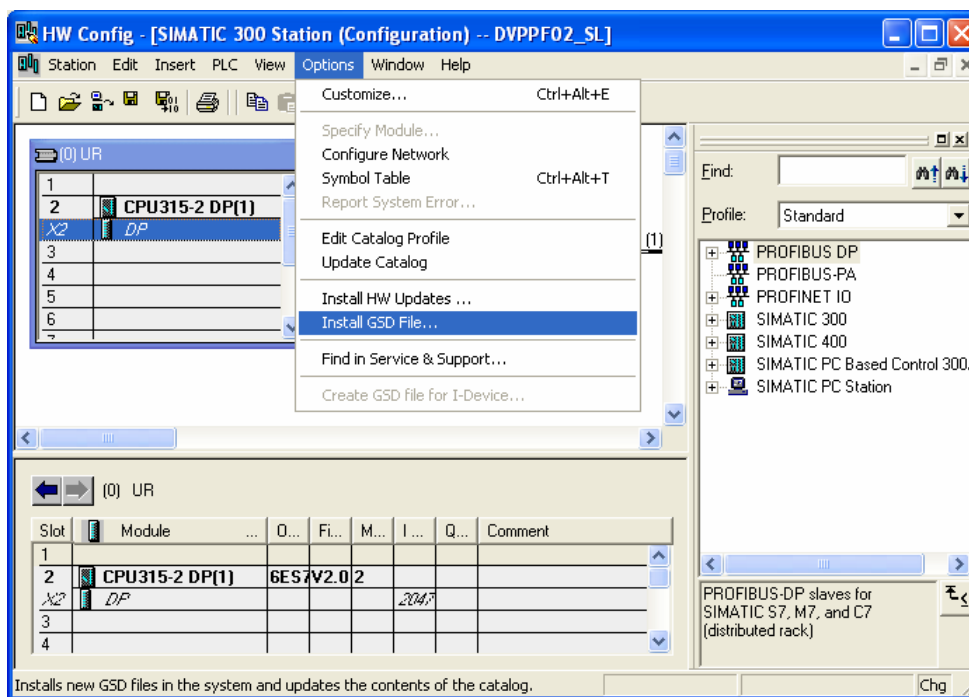

Figure 10-17

- Find the location to save the GSD file, select the GSD file to be installed and click “Install”, as Figure 10-18.

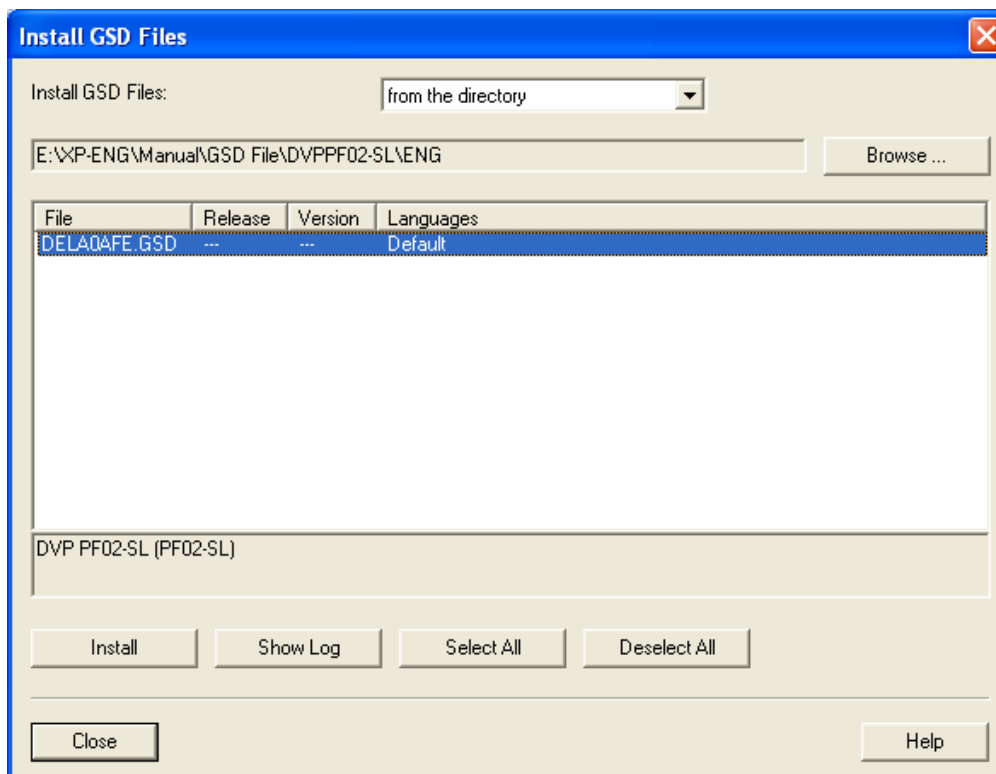

Figure 10-18

- After the GSD file is added, we can find DVPPF02-SL in the right-hand side window, as Figure 10-19. DVPPF02-SL is the new module created.

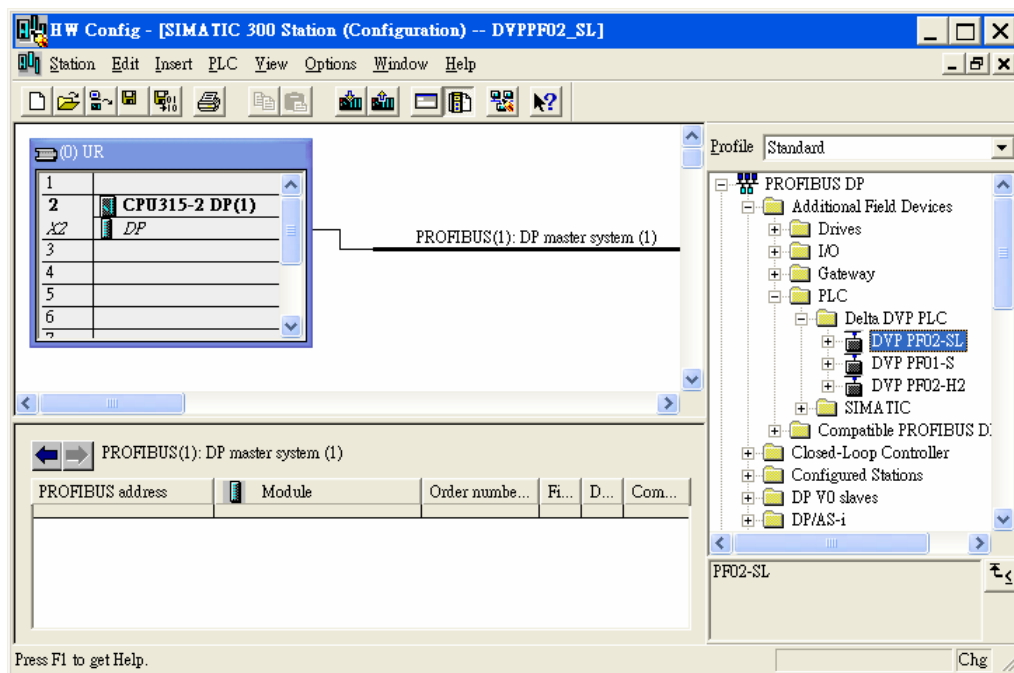

Figure 10-19

- Adding the slave DVPPF02-SL and setting up parameters

1. Select the PROFIBUS DP bus and double click the DVPPF02-SL in the right-hand side, as Figure 10-20, to open a dialog box.

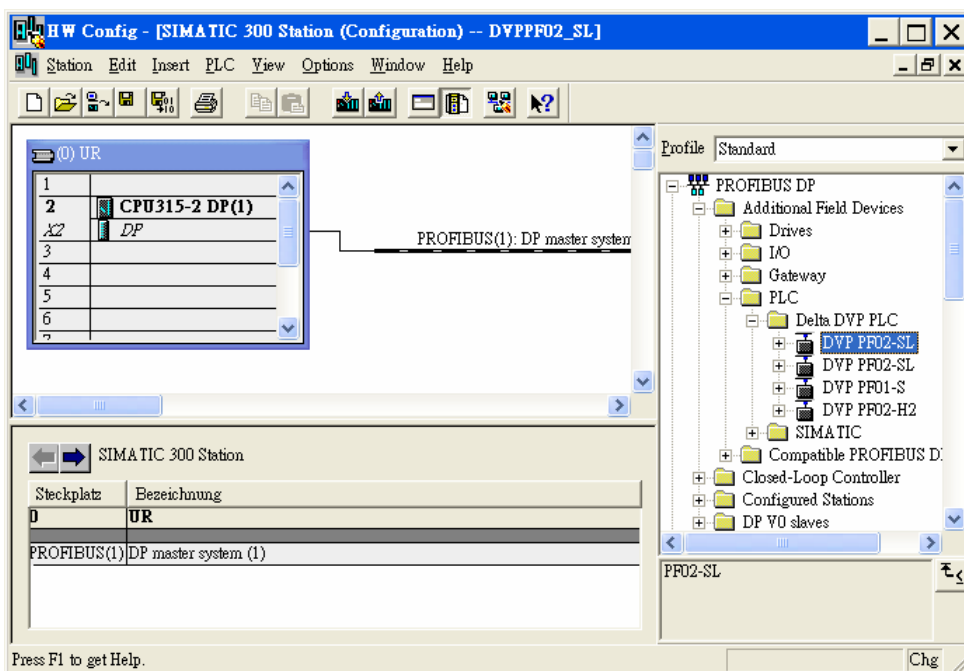

Figure 10-20

2. In this dialog box, select an address for DVPPF00-SL, as Figure 10-21. The address has to be consistent with the address set by the address switch on DVPPF02-SL. Next, click “OK”.

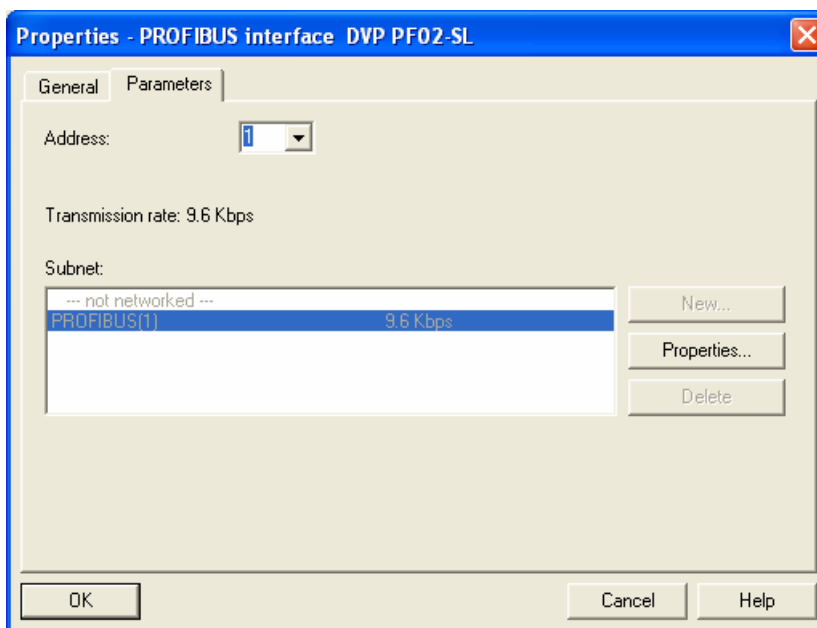

Figure 10-21

3. DVPPF02-SL is now added to the PROFIBUS DP bus, as Figure 10-22.

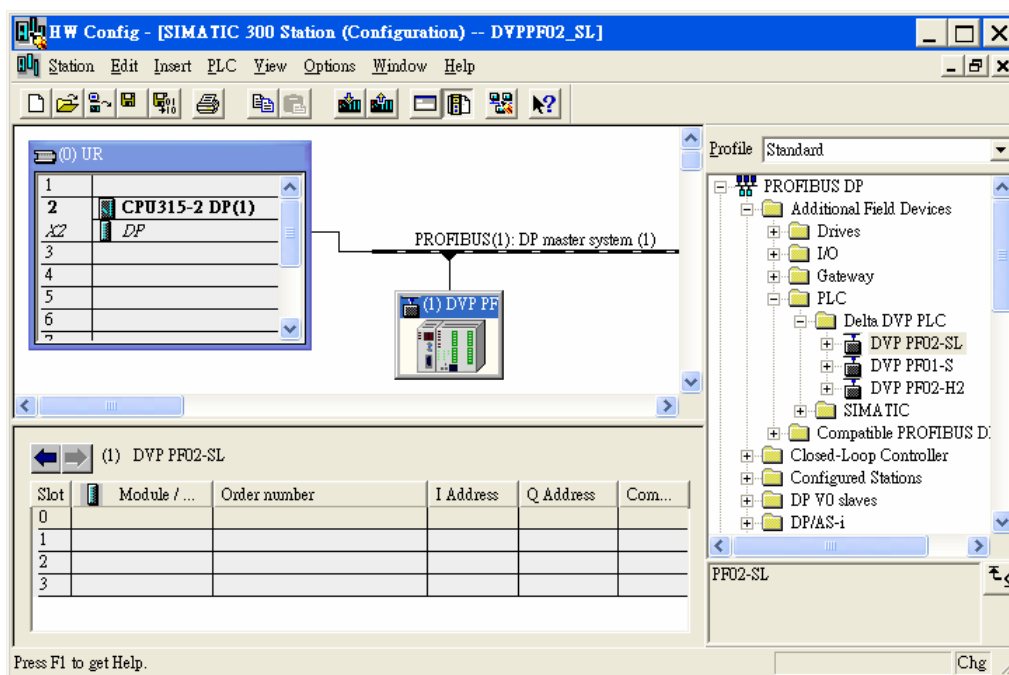

Figure 10-22

4. Select Slot 0 and double click “1 Word Out” on the right-hand side window, as Figure 10-23.

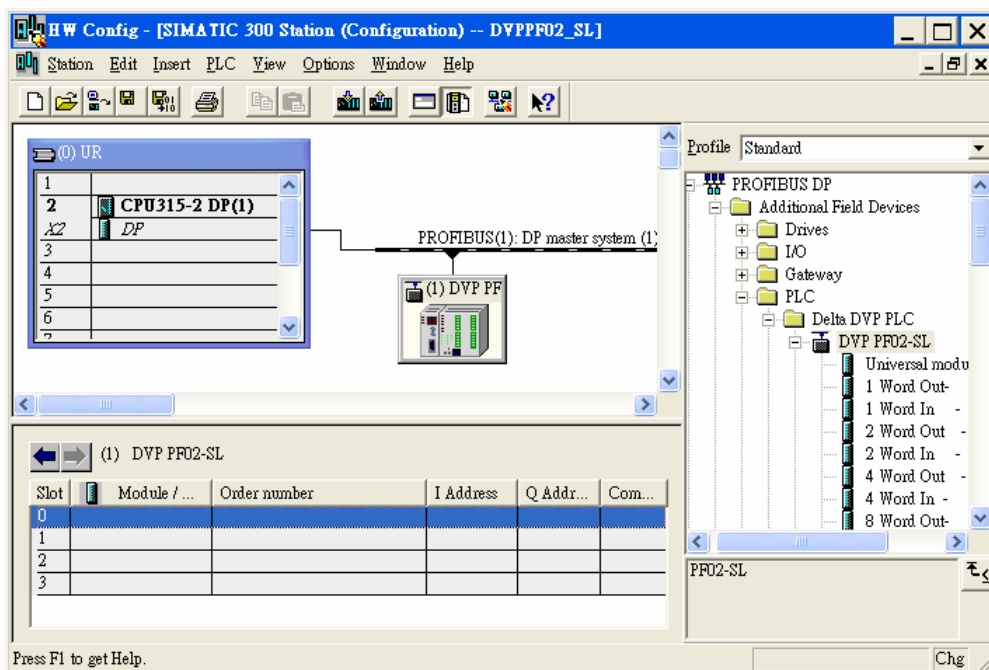

Figure 10-23

5. Configure “1 Word Out” to Slot 0, as Figure 10-24.

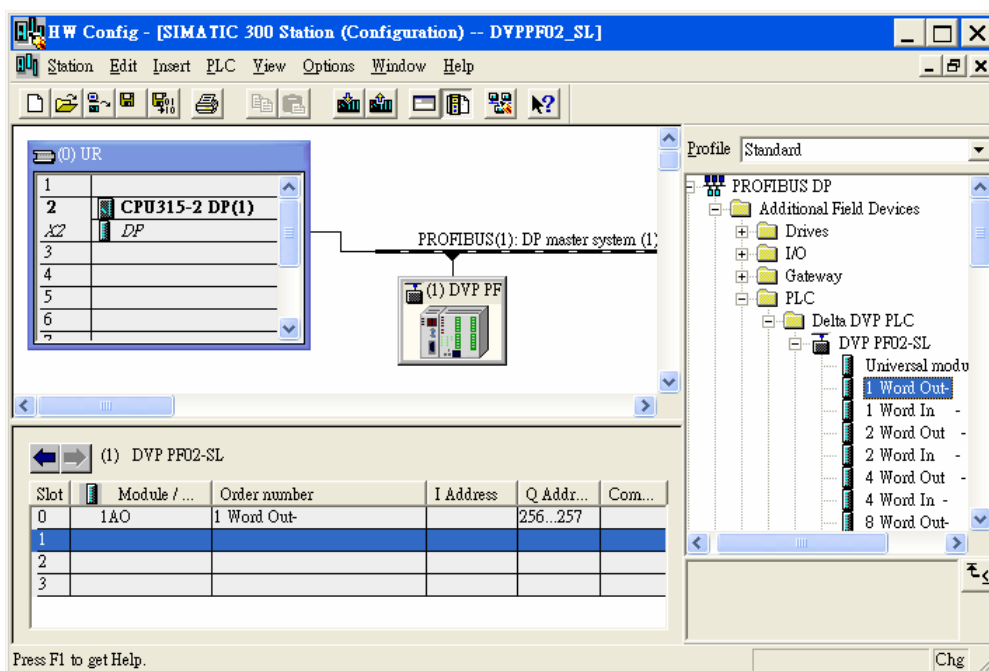

Figure 10-24

6. Configure other slots as the way Slot 0 is configured, as Figure 10-25. Finish configuring Slot 0 to Slot 2.

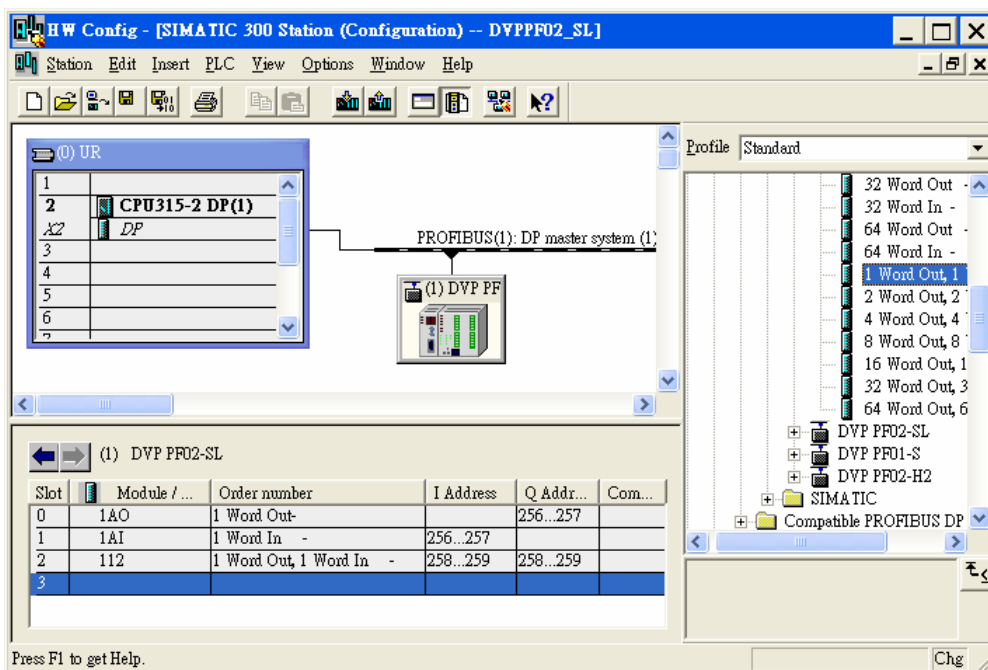

Figure 10-25

- After DVPPF02-SL is configured, double click the slave DVPPF02-SL on the PROFIBUS DP bus in Figure 10-25, and a dialog box will appear, as Figure 10-26. See 8.1 for definitions of the parameters in the dialog box.

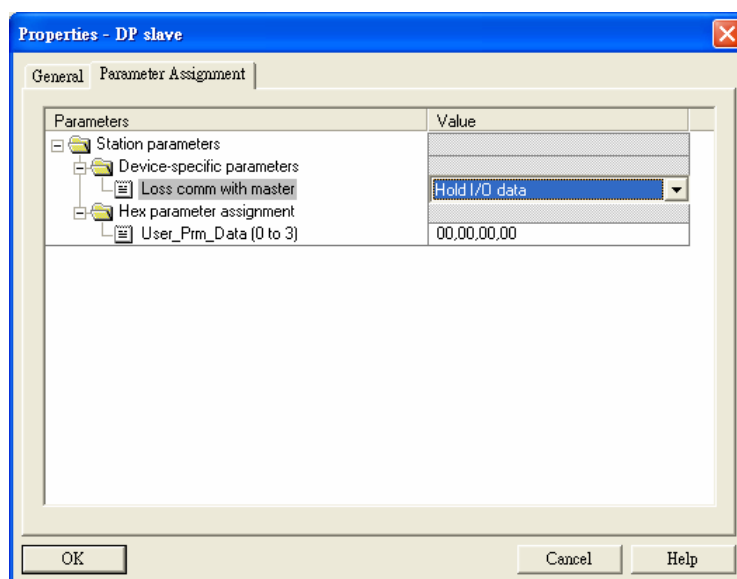

Figure 10-26

- Download the configured parameters. After the master establishes a connection with DVPPF02-SL, the NET LED on DVPPF02-SL will be constantly on in green color.

Data Mapping:

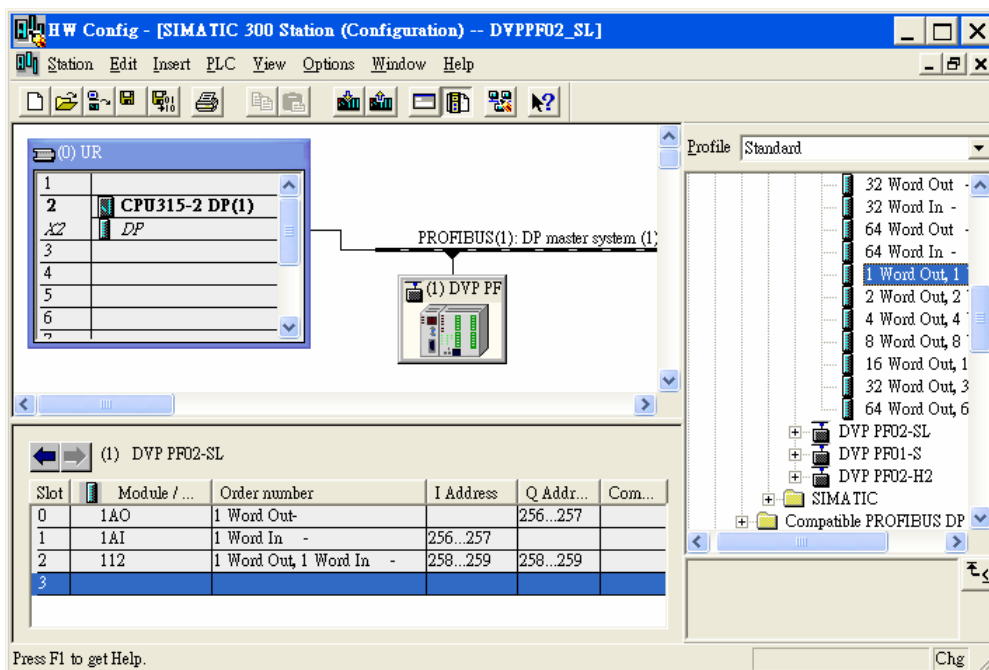

Figure 10-30

The data mapping for the parameters shown in Figure 10-30 is illustrated in Table 10-1.

Register in S7-300 (master)	Direction of data transmission in PROFIBUS DP network	Register in DVP-SV PLC
PQW256	➔	D6000
PQW258		D6001
PIW256	➔	D6250
PIW258		D6251

Table 10-1

Program Example:

The program for master

- Write the program for master in OB1.
- When M0.0 is ON, write 1000 into PQW256 and 2000 into PQW258. The master will then send the data in PQW256 and PQW258 to D6000 and D6001 in the slave through the PROFIBUS DP bus.
- When M0.0 is ON, write the data in PIW256 to MW10 and data in PIW258 to MW12. The data in PIW256 and PIW258 are sent from D6250 and D6251 in the slave to the master through the PROFIBUS DP bus.

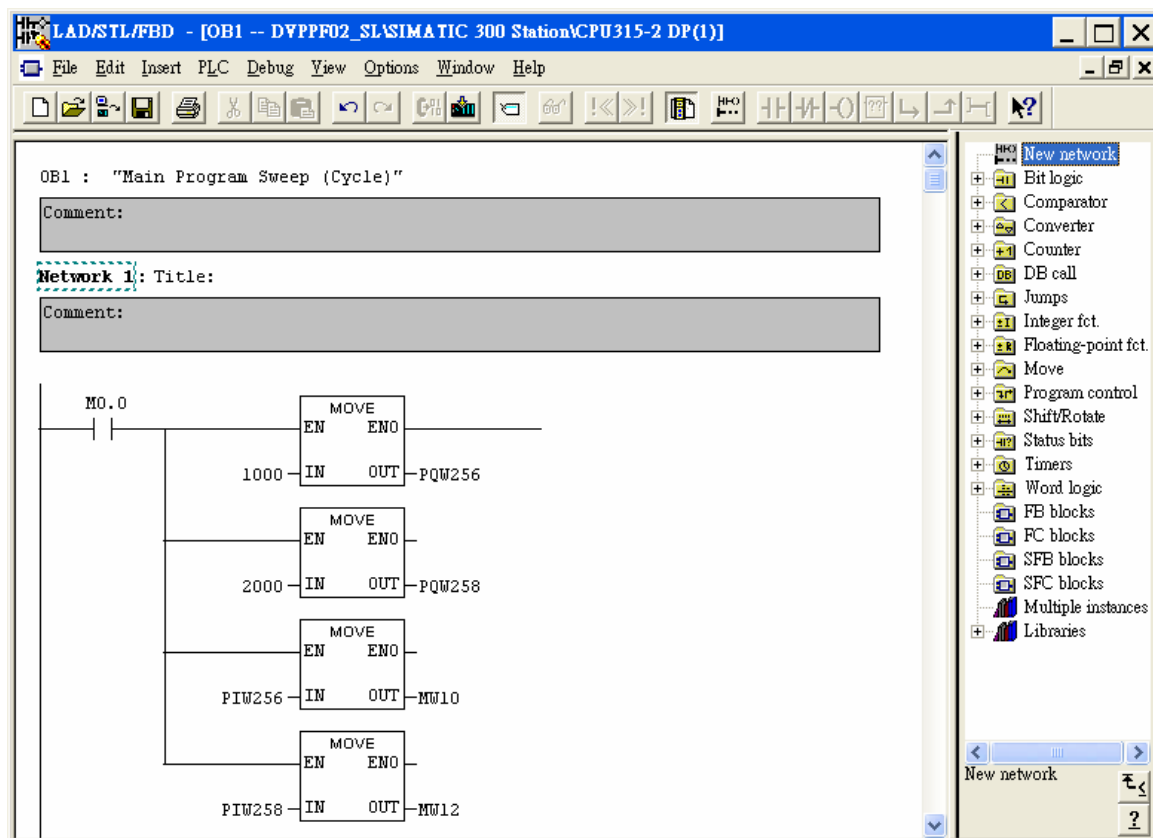

The program for slave

- Compile the program by Delta WPLSoft software. See the software help document for details.
- When M0 is ON, write 3000 into D6250 and 4000 into D6251. DVPPF02-SL will send the data in D6250 and D6251 to PIW256 and PIW258 in the master through the PROFIBUS DP bus.
- When M1 is ON, write the value in D6000 to D10 and the value in D6001 to D11. The data in D6000 and D6001 are sent from the master to DVPPF02-SL through the PROFIBUS DP bus.

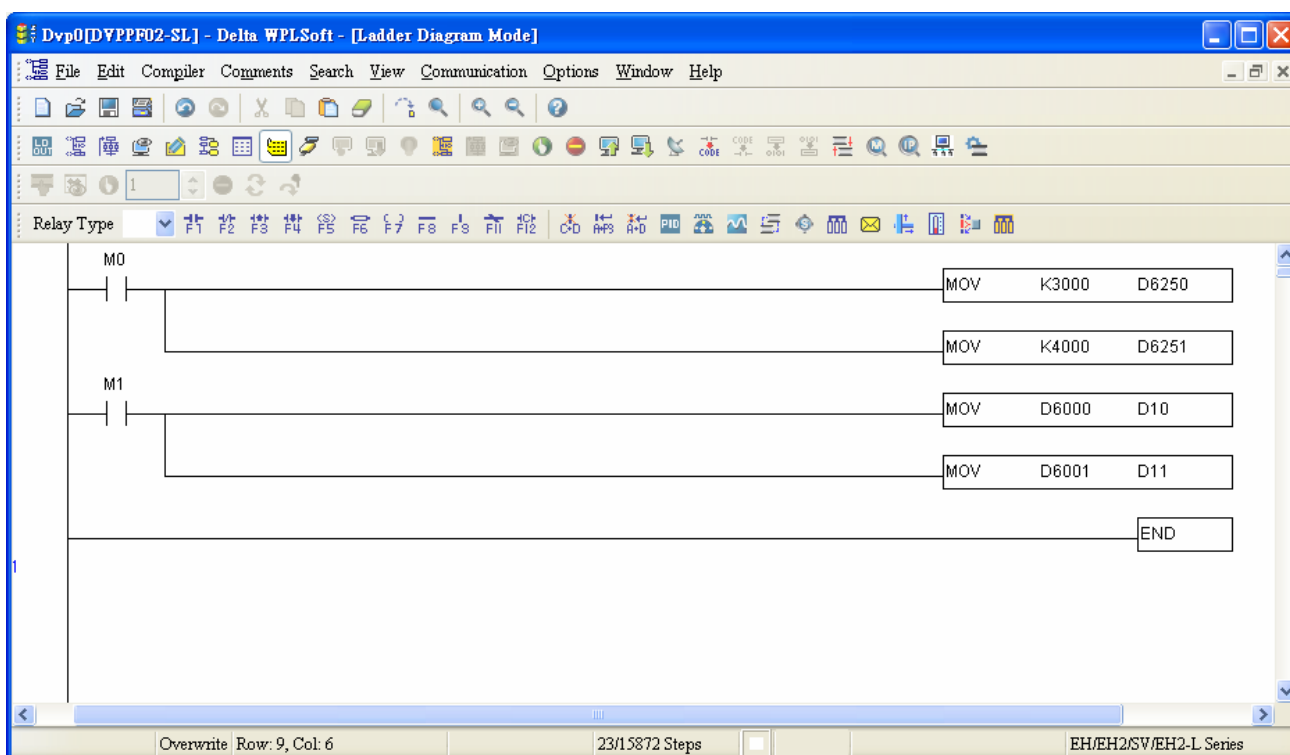

MEMO