

Automation for a Changing World

# Delta Industrial PC-Based Motion Control Solution Motion Control Card Series



[www.deltaww.com](http://www.deltaww.com)

 **DELTA**  
Smarter. Greener. Together.

## High-Speed Communication Solution for Multi-Axis and Synchronous Motion Control

The Delta Industrial PC-Based Motion Control Solution features a one-wire protocol for unimpeded access, achieving easy wiring, high synchronization, and excellent motion control performance. With Delta's flexible dynamic-link library (DLL), it easily connects Delta's motion control cards to multiple control devices such as servo motors, linear motors, remote digital I/O modules, analog modules, and pulse I/O modules for real-time data exchanges and high-precision technical programming via the PCI / PCIe interface.

The solution is the best integrated motion control platform that effortlessly fulfills the need for multi-axis and synchronous motion control with enhanced stability, flexible extension capabilities and versatile operation for industry upgrades.

### Four Major Features

- ▶ Supports DMCNET and EtherCAT communication motion control cards
- ▶ Connects to a variety of peripheral devices with standard Ethernet structure, such as servo motors, remote digital I/O and analog modules and stepping motors. Directly drives DD motors and linear motors.
- ▶ Offers a high-security IC device for each motion control card for confidential programming protection
- ▶ Fieldbus verification and validation software provides easy configuration with relevant parameters of the fieldbus communication segment and hardware system, reducing programming cost and third-party software



## Table of Contents

---

1	Introduction to Delta Industrial PC-Based Motion Control Solution
3	DMCNET System Configuration and Product Features
9	IPC Motion Platform (IMP 1.5)
14	Soft Numeric Control (SNC)
19	Fieldbus Verification and Validation - EzDMC Software
21	EtherCAT System Configuration and Product Features
23	Fieldbus Verification and Validation - EcNavi Software
25	Specifications of DMCNET Motion Control Cards
35	Specifications of EtherCAT Motion Control Cards
45	DMCNET Remote Modules
51	ASDA-A3-F DMCNET Servo Drive Specifications
53	ASDA-A2-F DMCNET Servo Drive Specifications
55	ASDA-B2-F DMCNET Servo Drive Specifications
57	ASDA-M DMCNET Servo Drive Specifications
61	EtherCAT Remote Modules
68	ASDA-A2-E EtherCAT Servo Drive Specifications
72	Ordering Information

# DMCNET System Configuration

<b>Motion Control Cards</b>	<p>Motion Control Cards</p> <table border="0"> <tr> <td data-bbox="411 398 576 495"></td> <td data-bbox="651 398 810 495"></td> <td data-bbox="852 398 1002 495"></td> <td data-bbox="1038 398 1189 495"></td> <td data-bbox="1262 398 1426 495"></td> </tr> <tr> <td data-bbox="427 504 587 577"> <b>PCI-DMC-A02</b>  <b>PAGE 25</b> </td> <td data-bbox="655 504 815 577"> <b>PCI-DMC-B01</b>  <b>PAGE 27</b> </td> <td data-bbox="847 504 1007 577"> <b>PCI-DMC-B02</b>  <b>PAGE 29</b> </td> <td data-bbox="1038 504 1198 577"> <b>PCI-DMC-B03</b>  <b>PAGE 31</b> </td> <td data-bbox="1262 504 1422 577"> <b>PCI-DMC-F02</b>  <b>PAGE 33</b> </td> </tr> </table>						<b>PCI-DMC-A02</b> <b>PAGE 25</b>	<b>PCI-DMC-B01</b> <b>PAGE 27</b>	<b>PCI-DMC-B02</b> <b>PAGE 29</b>	<b>PCI-DMC-B03</b> <b>PAGE 31</b>	<b>PCI-DMC-F02</b> <b>PAGE 33</b>		
<b>PCI-DMC-A02</b> <b>PAGE 25</b>	<b>PCI-DMC-B01</b> <b>PAGE 27</b>	<b>PCI-DMC-B02</b> <b>PAGE 29</b>	<b>PCI-DMC-B03</b> <b>PAGE 31</b>	<b>PCI-DMC-F02</b> <b>PAGE 33</b>									
<b>Servo Systems</b>	<p>Servo Drives and Motors</p> <table border="0"> <tr> <td data-bbox="469 629 592 757"></td> <td data-bbox="730 629 869 757"></td> <td data-bbox="979 629 1139 757"></td> <td data-bbox="1235 629 1422 757"></td> </tr> <tr> <td data-bbox="448 766 587 840"> <b>ASDA-A3-F</b>  <b>PAGE 51</b> </td> <td data-bbox="724 766 863 840"> <b>ASDA-A2-F</b>  <b>PAGE 53</b> </td> <td data-bbox="1002 766 1141 840"> <b>ASDA-B2-F</b>  <b>PAGE 55</b> </td> <td data-bbox="1262 766 1401 840"> <b>ASDA-M</b>  <b>PAGE 57</b> </td> </tr> </table>					<b>ASDA-A3-F</b> <b>PAGE 51</b>	<b>ASDA-A2-F</b> <b>PAGE 53</b>	<b>ASDA-B2-F</b> <b>PAGE 55</b>	<b>ASDA-M</b> <b>PAGE 57</b>				
<b>ASDA-A3-F</b> <b>PAGE 51</b>	<b>ASDA-A2-F</b> <b>PAGE 53</b>	<b>ASDA-B2-F</b> <b>PAGE 55</b>	<b>ASDA-M</b> <b>PAGE 57</b>										
<b>Digital Remote Modules</b>	<table border="0"> <tr> <td data-bbox="236 898 368 994"></td> <td data-bbox="624 898 852 994"></td> <td data-bbox="1031 909 1259 994"></td> </tr> <tr> <td data-bbox="229 1019 571 1081"> <b>32 Digital Input Remote Module</b>  <b>ASD-DMC-RM32MN</b> </td> <td data-bbox="619 1019 960 1081"> <b>64 Digital Input Remote Module</b>  <b>ASD-DMC-RM64MN</b> </td> <td data-bbox="1024 1019 1315 1081"> <b>Digital I/O Remote Module</b>  <b>HMC-RIO3232RT5</b> </td> </tr> <tr> <td data-bbox="236 1120 368 1216"></td> <td data-bbox="624 1120 852 1216"></td> <td data-bbox="1031 1120 1163 1216"></td> </tr> <tr> <td data-bbox="229 1240 592 1303"> <b>32 Digital Output Remote Module</b>  <b>ASD-DMC-RM32NT</b> </td> <td data-bbox="619 1240 981 1303"> <b>64 Digital Output Remote Module</b>  <b>ASD-DMC-RM64NT</b> </td> <td data-bbox="1024 1240 1476 1303"> <b>32 Digital I/O Remote Module</b>  <b>ASD-DMC-RM32PT</b> </td> </tr> </table> <p style="text-align: right;"><b>PAGE 33 ~ 37</b></p>				<b>32 Digital Input Remote Module</b> <b>ASD-DMC-RM32MN</b>	<b>64 Digital Input Remote Module</b> <b>ASD-DMC-RM64MN</b>	<b>Digital I/O Remote Module</b> <b>HMC-RIO3232RT5</b>				<b>32 Digital Output Remote Module</b> <b>ASD-DMC-RM32NT</b>	<b>64 Digital Output Remote Module</b> <b>ASD-DMC-RM64NT</b>	<b>32 Digital I/O Remote Module</b> <b>ASD-DMC-RM32PT</b>
<b>32 Digital Input Remote Module</b> <b>ASD-DMC-RM32MN</b>	<b>64 Digital Input Remote Module</b> <b>ASD-DMC-RM64MN</b>	<b>Digital I/O Remote Module</b> <b>HMC-RIO3232RT5</b>											
<b>32 Digital Output Remote Module</b> <b>ASD-DMC-RM32NT</b>	<b>64 Digital Output Remote Module</b> <b>ASD-DMC-RM64NT</b>	<b>32 Digital I/O Remote Module</b> <b>ASD-DMC-RM32PT</b>											
<b>Pulse Remote Module</b>	<table border="0"> <tr> <td data-bbox="488 1395 770 1518"></td> <td data-bbox="804 1424 1166 1487"> <b>4-Channel Pulse Remote Module</b>  <b>ASD-DMC-RM04PI</b> </td> </tr> </table> <p style="text-align: right;"><b>PAGE 35</b></p>		<b>4-Channel Pulse Remote Module</b> <b>ASD-DMC-RM04PI</b>										
	<b>4-Channel Pulse Remote Module</b> <b>ASD-DMC-RM04PI</b>												
<b>Analog Remote Modules</b>	<table border="0"> <tr> <td data-bbox="288 1608 459 1731"></td> <td data-bbox="488 1626 767 1718"> <b>4-Channel Analog Output Remote Module</b>  <b>ASD-DMC-RM04DA</b> </td> <td data-bbox="890 1608 1061 1731"></td> <td data-bbox="1098 1626 1362 1718"> <b>4-Channel Analog Input Remote Module</b>  <b>ASD-DMC-RM04AD</b> </td> </tr> </table> <p style="text-align: right;"><b>PAGE 36</b></p>		<b>4-Channel Analog Output Remote Module</b> <b>ASD-DMC-RM04DA</b>		<b>4-Channel Analog Input Remote Module</b> <b>ASD-DMC-RM04AD</b>								
	<b>4-Channel Analog Output Remote Module</b> <b>ASD-DMC-RM04DA</b>		<b>4-Channel Analog Input Remote Module</b> <b>ASD-DMC-RM04AD</b>										
<b>Gateway Type Remote Modules</b>	<table border="0"> <tr> <td data-bbox="293 1809 373 1995"></td> <td data-bbox="443 1854 699 1948"> <b>Gateway Type Remote Power Coupler</b>  <b>ASD-DMC-GA01</b> </td> <td data-bbox="927 1827 975 1980"></td> <td data-bbox="1043 1854 1331 1948"> <b>Gateway Type 1-Channel Pulse Remote Module</b>  <b>ASD-DMC-GE01PH</b> </td> </tr> </table> <p style="text-align: right;"><b>PAGE 38</b></p>		<b>Gateway Type Remote Power Coupler</b> <b>ASD-DMC-GA01</b>		<b>Gateway Type 1-Channel Pulse Remote Module</b> <b>ASD-DMC-GE01PH</b>								
	<b>Gateway Type Remote Power Coupler</b> <b>ASD-DMC-GA01</b>		<b>Gateway Type 1-Channel Pulse Remote Module</b> <b>ASD-DMC-GE01PH</b>										

# Delta's High-Speed Motion Control System - DMCNET Product Features

Delta's Motion Control NETwork (DMCNET) is a high speed, real-time communication system, capable of controlling up to 12 axes of servo system units within 1ms simultaneously: with 3-axis helical and linear interpolation in 4 groups, or 2-axis linear and arc interpolation in 6 groups. It supports 64-bit dual precision floating point, allowing high-precision system calculations and flexible operation, and also absolute commands, incremental commands and T-curve / S-curve velocity profiles for different uses. With built-in position, speed and torque control modes, and 35 homing modes, it is able to receive real-time servo information, parameters, or change control modes via communication command, offering fast communication and motion control for various applications.

## DMCNET Motion Control Structure

DMCNET is equipped with the high-speed and reliable one-wire DMCNET communication protocol for diverse motion control applications. Adapted depending on customer's needs, Delta's PCI motion control cards are available in three series: the 12-axis PCI-DMC-A02, 6-axis PCI-DMC-F02 with digital I/O interfaces and the PCI-DMC-B01 with pulse compare & capture functions. All series are able to connect to multiple servo systems, such as the high performance ASDA-A2-F Series, standard ASDA-B2-F Series, or ASDA-A2R Series. Combined with Delta's linear motors, the series establishes a total motion control solution enabling lower system cost and superior performance to increase end-product value and competitiveness.

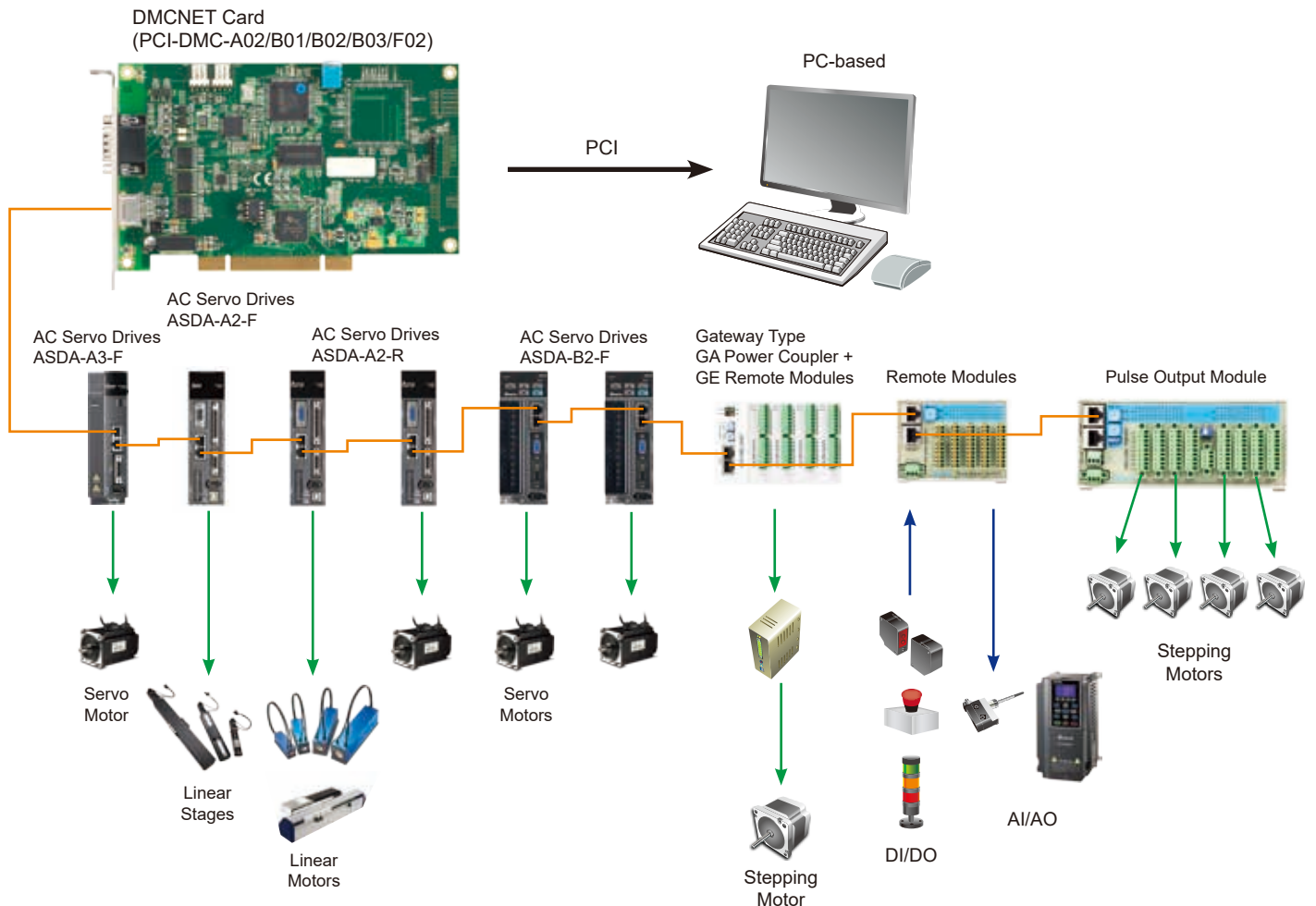

## DMCNET Communication

The DMCNET is a motion control communication network that is able to control up to 12 servo drives or modules in serial connection on the same fieldbus, simplifying wiring as well as saving cost. With its fast and stable communication speed that deals with commands of the servo motors and modules within 1ms simultaneously, DMCNET offers an easy, fast and stable communication system solution that makes motion control easier.

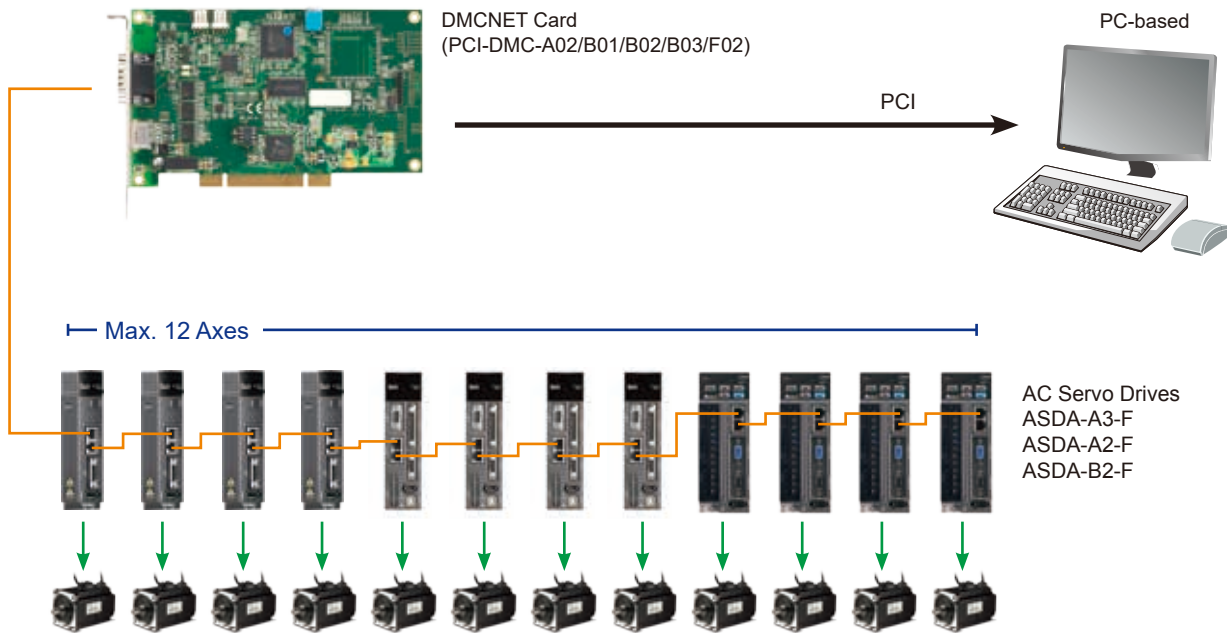

## DMCNET I/O Control Structure

In a pure I/O control structure, DMCNET is capable of controlling up to 12 remote module units, which include a total of 768 digital inputs and outputs, offering customers a more flexible and effective solution.

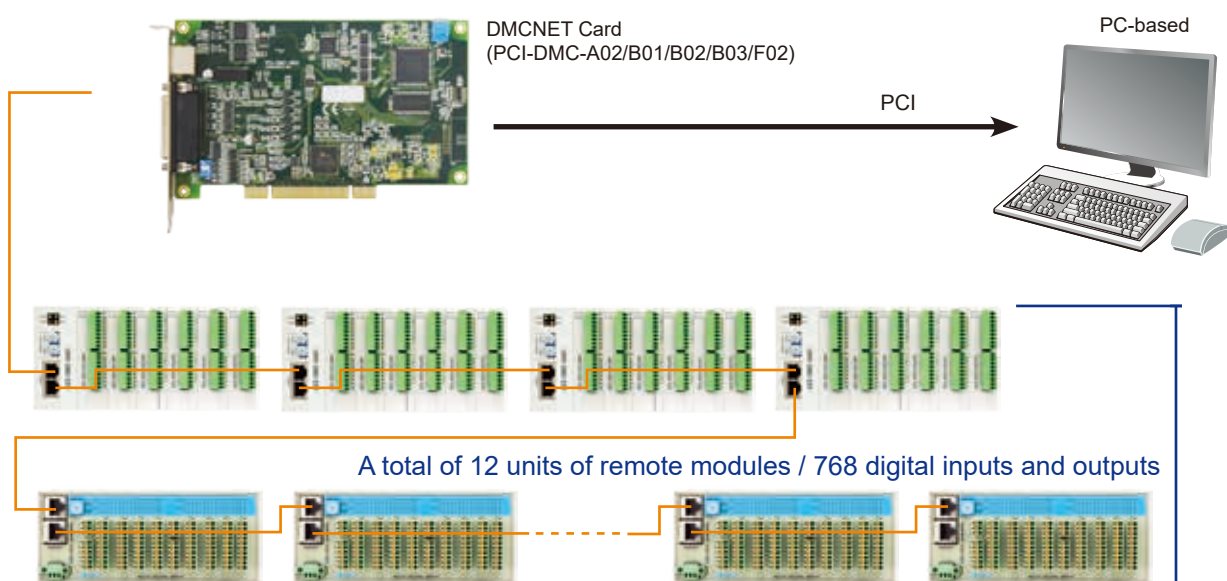

# Motion Control Functions

## Multi-Group Synchronous Control

The DMCNET is capable of controlling 12 servo system units or 4 groups, 3-axis interpolation algorithms synchronously, realizing simultaneous 3-axis linear interpolation, 2-axis arc interpolation, 3-axis helical interpolation and continuous interpolation. It can also transfer the data of 12 servo motor units, or 768 digital inputs and outputs within 1ms simultaneously.

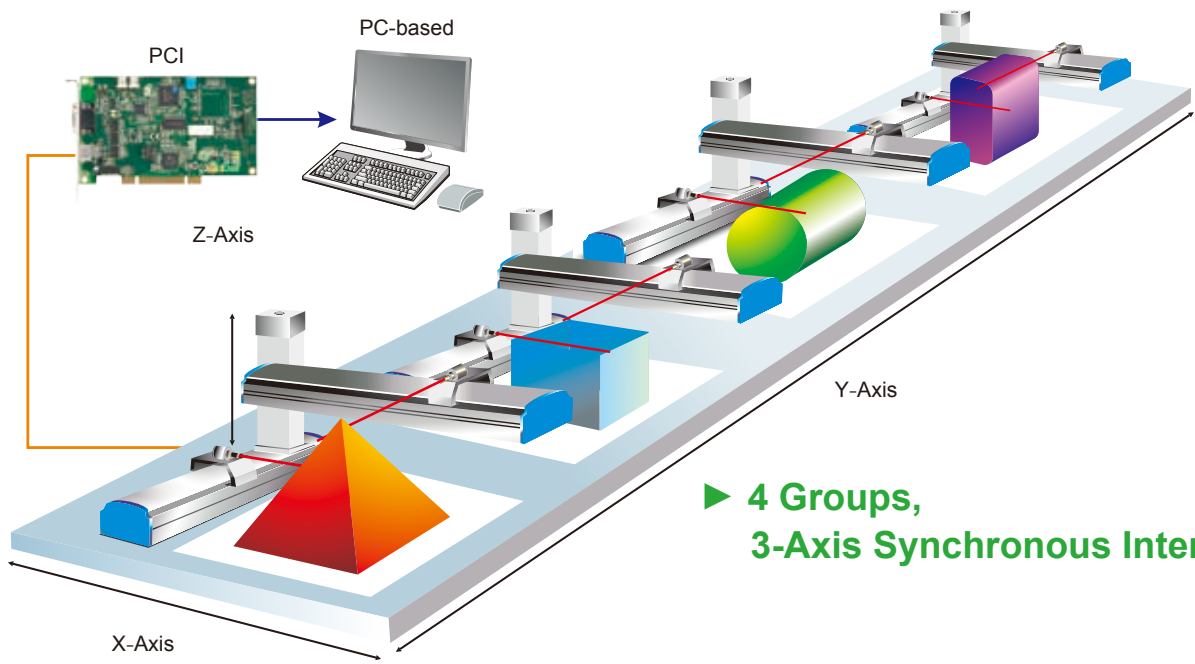

► 4 Groups,  
3-Axis Synchronous Interpolation

► 3-Axis Interpolation

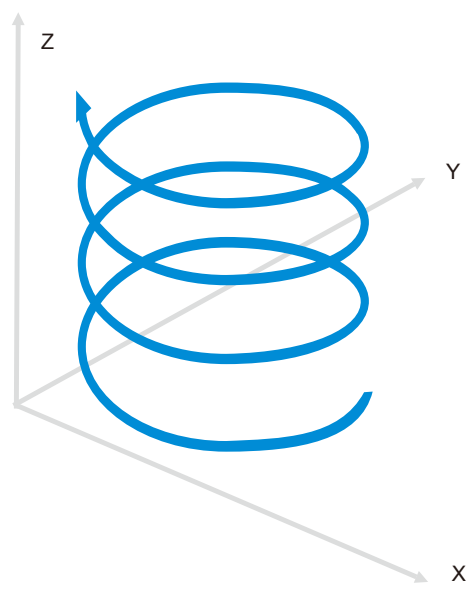

► 2-Axis Interpolation

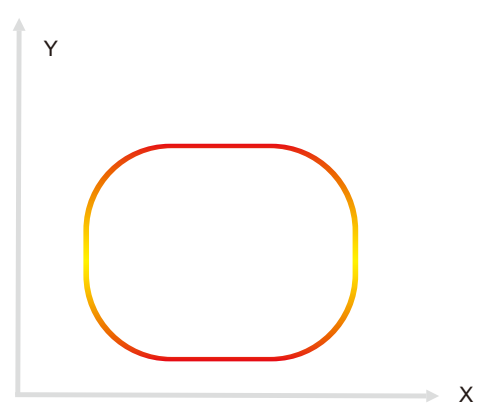

# Standard / Economical Motion Control Card PCI-DMC-A02 / PCI-DMC-F02

## Rapid Configuration and Easy Control with Digital I/O Interfaces

The PCI-DMC-A02 and PCI-DMC-F02 motion control cards are built-in with digital local I/O interfaces that are equipped with up to 32 digital inputs and 24 digital outputs. Without controlling through communication, the motion cards are able to rapidly capture and identify IO messages, enhancing the controlling efficiency of the system. For users who have fewer IO needs, this helps save cost with extended axes and rapid response (the PCI-DMC-F02 motion control card controls up to 6 axes). In addition, the motion cards can connect to a manual pulse generator (MPG) and conduct system adjustment directly, achieving real-time configuration and flexible operation.

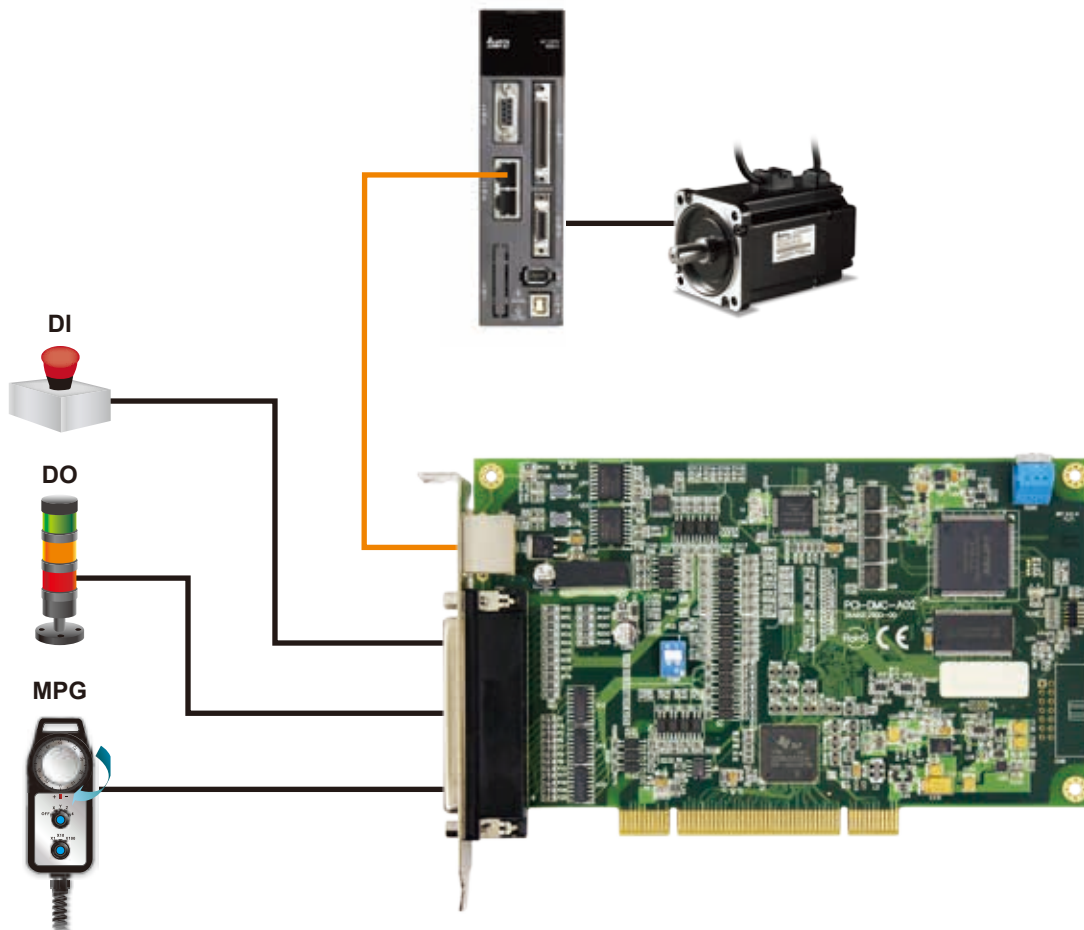



# Advanced Motion Control Card PCI-DMC-B01

## Real-time Capture and Compare Functions

The capture function inputs a retrieve pulse to the control cards via an encoder and performs a pulse compare to remotely trigger the camera shutter and take pictures in equally spaced or unequally spaced pulse positions at a set time interval.

The PCI-DMC-B01 motion card provides 2 groups of real time pulse capture and 2 groups of compare functions.

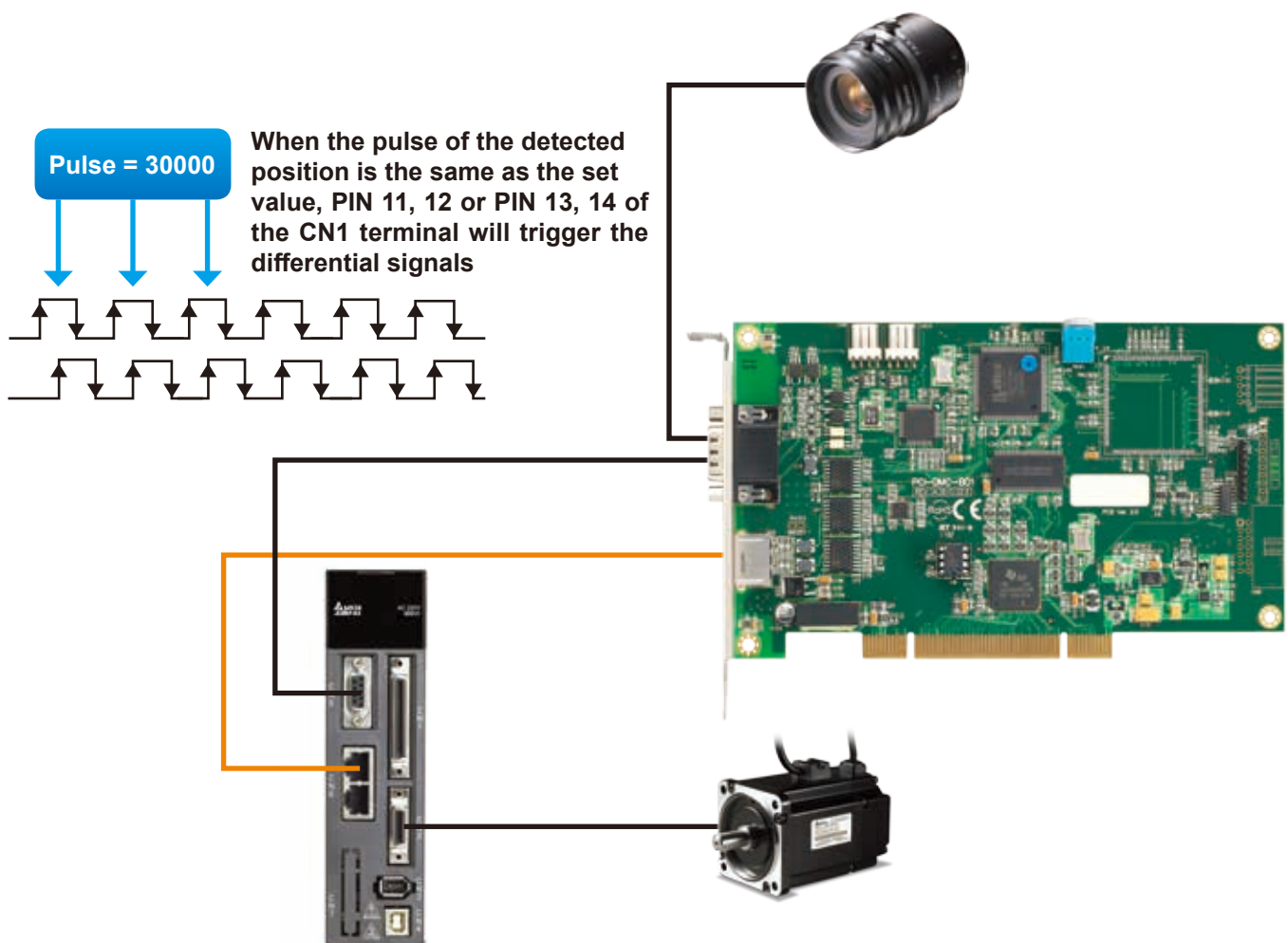

# Advanced Motion Control Card PCI-DMC-B02

## Real-time Capture and 2D Compare Functions

- The X and Y-axis path planning function can set the position and inputs the retrieve pulses of X and Y-axis to the control cards via an encoder. Users set 2D compare condition and speed to remotely trigger the camera shutter and take pictures.
- The PCI-DMC-B02 motion card provides 3 groups of real time pulse capture and 10 groups of compare functions.

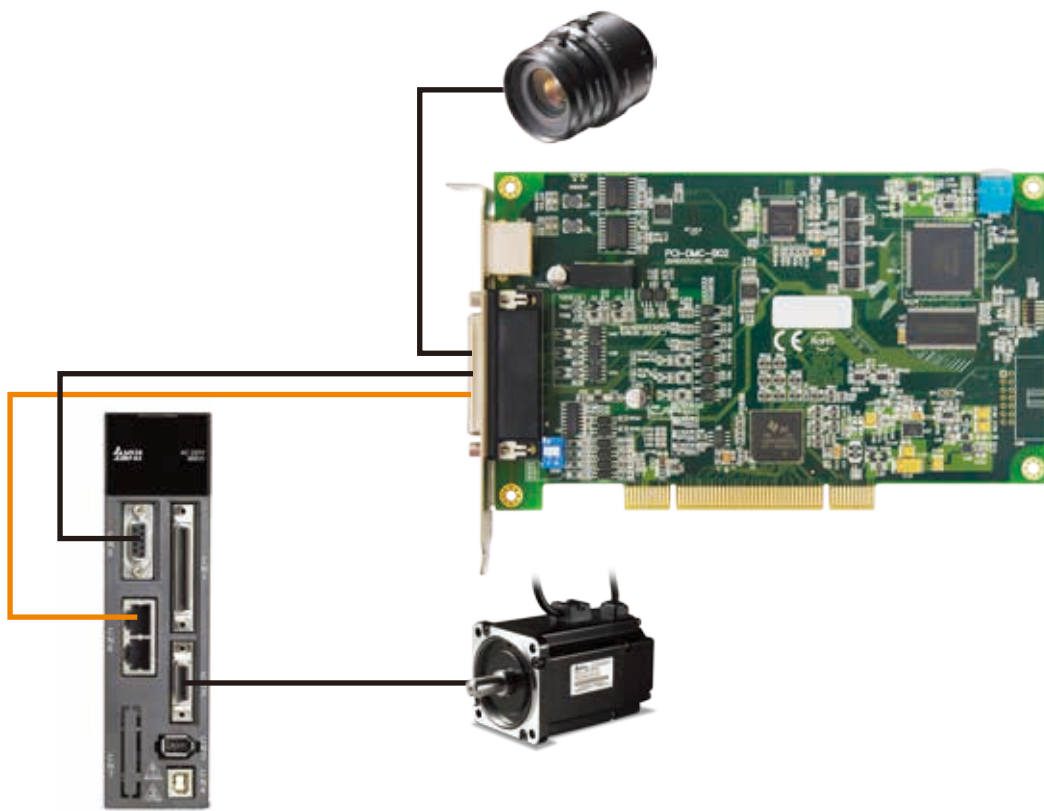

# Advanced Motion Control Card PCI-DMC-B03

## Real-time Capture and Multiple Compare Functions

- The capture function inputs a retrieve pulse to the control cards via an encoder and performs a pulse compare to remotely trigger the camera shutter and take pictures in equally spaced or unequally spaced pulse positions at a set time interval.
- The PCI-DMC-B03 motion card provides 3 groups of real time pulse capture, 4 groups of equally spaced compare pulse triggers, and 6 groups of unequally spaced compare pulse triggers.

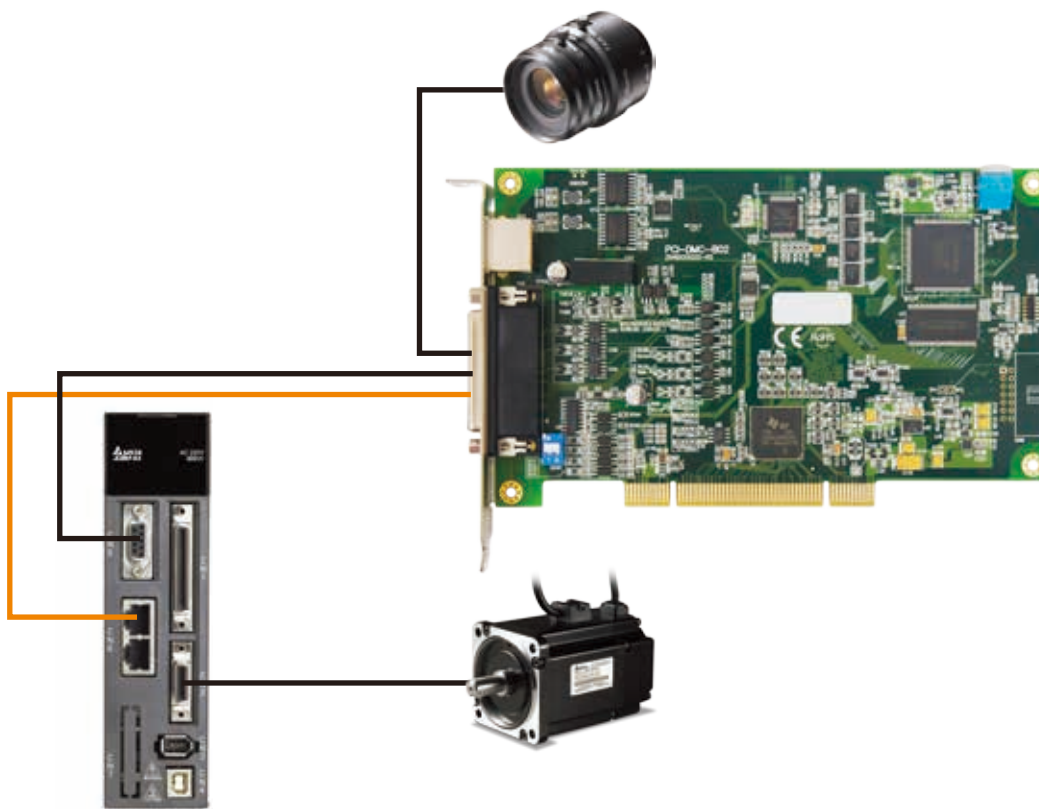

# IPC Motion Platform (IMP 1.5)

## A Simple and Fast Setup Development Platform for Unsurpassed Motion Control

The IMP is a high-speed, flexible and scalable development platform which combines powerful motion control functions and integrates Delta's HMI editing and PLC logic programming software tools to achieve complex and precise motion control based on customers' requirements.

- **Powerful Motion Control Core:** Upgrades Delta's PAC and PC with a motion control card installed to become an advanced motion controller, which integrates functions of motion control, HMI, PLC and high-speed communication fieldbus in one unit.
- **Customized Platform for Secondary Development:** Combines with Delta's standard HMI editor DOPSoft and PLC editor WPLSoft in one customer-driven platform, the platform makes complex programming and development easy and time-saving without depending on technical support from the manufacturer.
- **Scalable Communication for Expandable Network:** Through PCI extension slots, three DMCNET communication networks with up to 36 stations can be established, which means 36 axes of servo motors can be controlled simultaneously without connecting to any remote modules.
- **Industry-Oriented Controller:** Soft Numeric Control (SNC) and Motion Program Macro (MPM) are provided for users to adjust and modify self-developed motion paths and commands according to changing application requirements.
- **Standard Communication Interfaces:** Support built-in standard MODBUS and MODBUS TCP gateways to enable more convenient data transmission and exchange between machines.

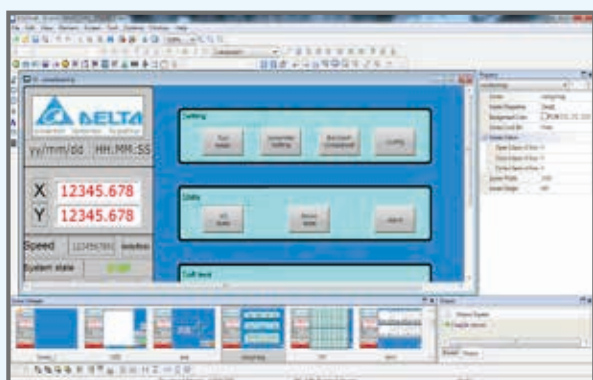

**HMI Editor**

After installing on a PC, even without C or C++ programming language, the HMI Editor DOPSoft 3.0 provides a simple path and quick downloading of customized user interfaces to Delta's PAC with the IMP for easy programming and system design. For specific industry applications, such as numerical control (NC), the IMP contains numerous example programs to provide a practical aid in real time for machine verification and evaluation.

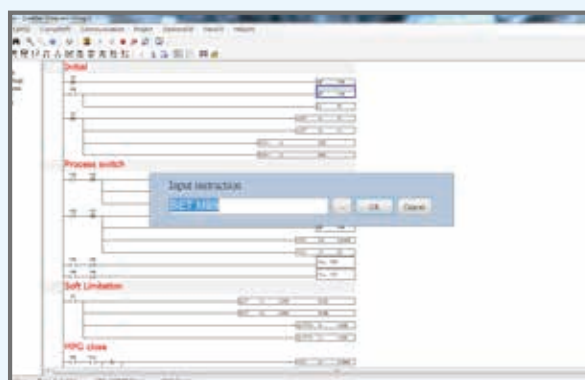

**PLC Editor**

The IMP integrates Delta's PLC editor WPLSoft that offers users a ladder diagram editing environment to develop PLC programs for secondary development and to customize their applications. The PLC editor also accepts motion control commands and allows users to control servo systems and remote I/O modules to complete single-axis motions, multi-axis linear interpolation, arc interpolation, continuous speed and other motions, fulfilling the needs of users who are familiar with the PLC.

# IMP System Configuration with DMCNET

## IMP - Powerful Motion Control Kernel



VGA Display

The IMP is the kernel of the system, like the firmware of a motion controller, which runs on one of the processors of a multi-core PC or PAC with a plug-in motion control card. Without adding extra hardware, users can download HMI screens and PLC programs, edit user-defined graphical interfaces and execute programming logic control to run machine applications via software and VGA display only.

The IMP is a powerful motion control kernel and it simplifies connectivity and delivers more flexible functionality for the entire system. Not only is MODBUS communication equipped as standard, Soft Numeric Control (SNC) and Motion Program Macro (MPM) are also provided for users to change and calibrate motion paths and commands for different application requirements.

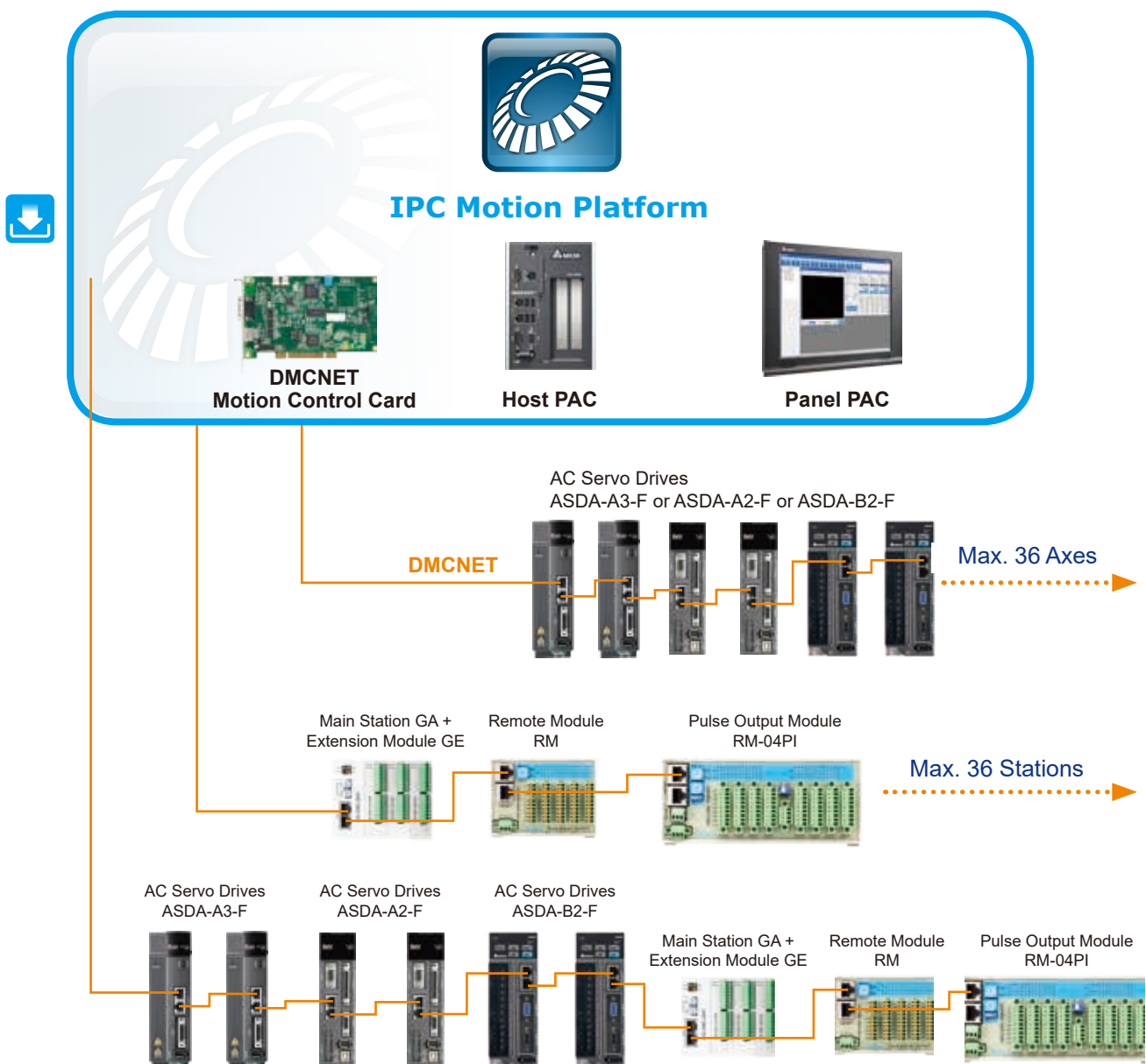

## IMP System Configuration with EtherCAT



VGA Display

### IMP - Powerful Motion Control Kernel

The IMP is the kernel of the system, like the firmware of a motion controller, which runs on one of the processors of a multi-core PC or PAC with a plug-in motion control card. Without adding extra hardware, users can download HMI screens and PLC programs, edit user-defined graphical interfaces and execute programming logic control to run machine applications via software and VGA display only.

The IMP is a powerful motion control kernel and it simplifies connectivity and delivers more flexible functionality for the entire system. Not only is MODBUS communication equipped as standard, Soft Numeric Control (SNC) and Motion Program Macro (MPM) are also provided for users to change and calibrate motion paths and commands for different application requirements.

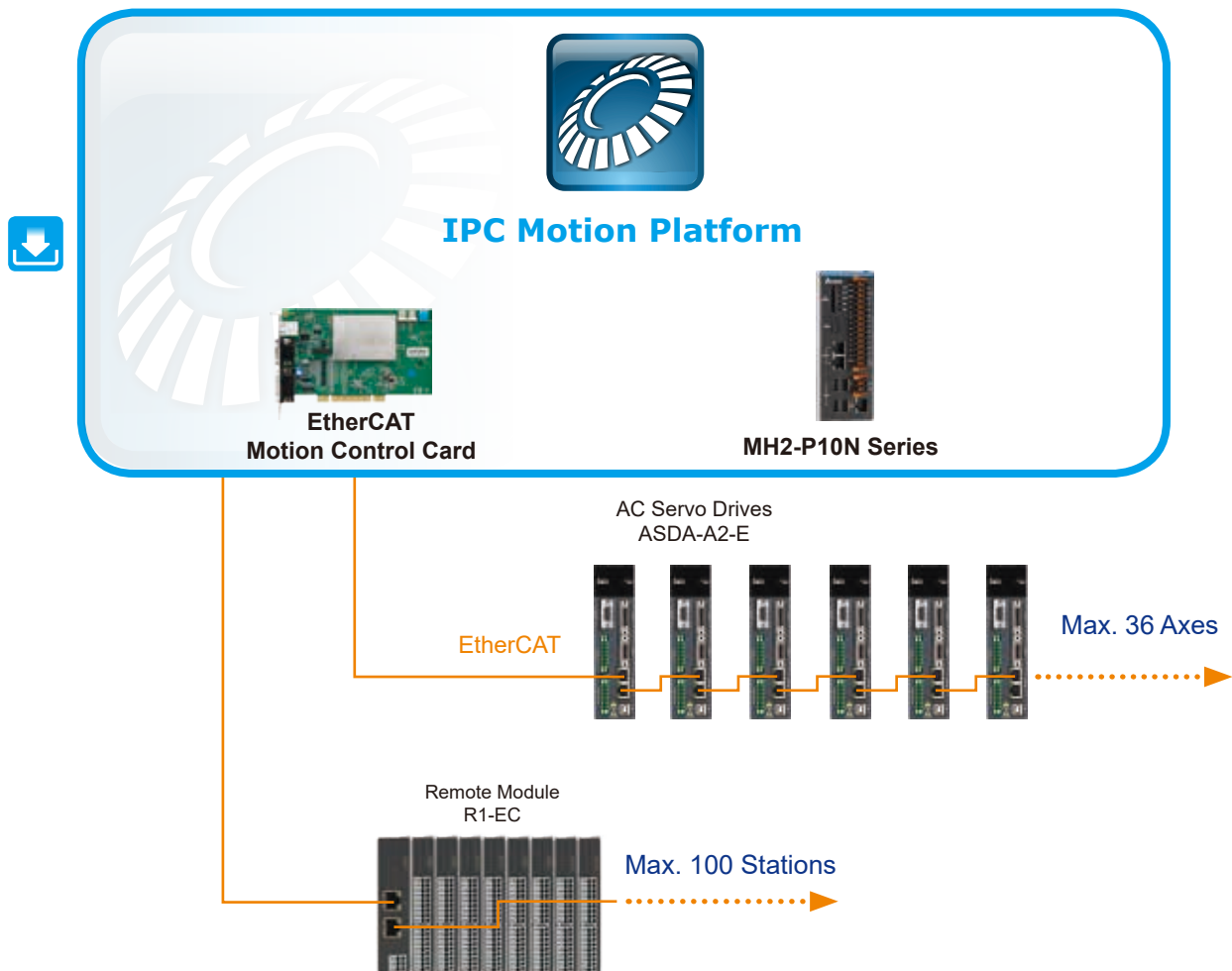

# Soft Numeric Control (SNC)

## SNC Software Structure with DMCNET

MH1-XXD Series



MP1 Series



PCI-DMC-B01

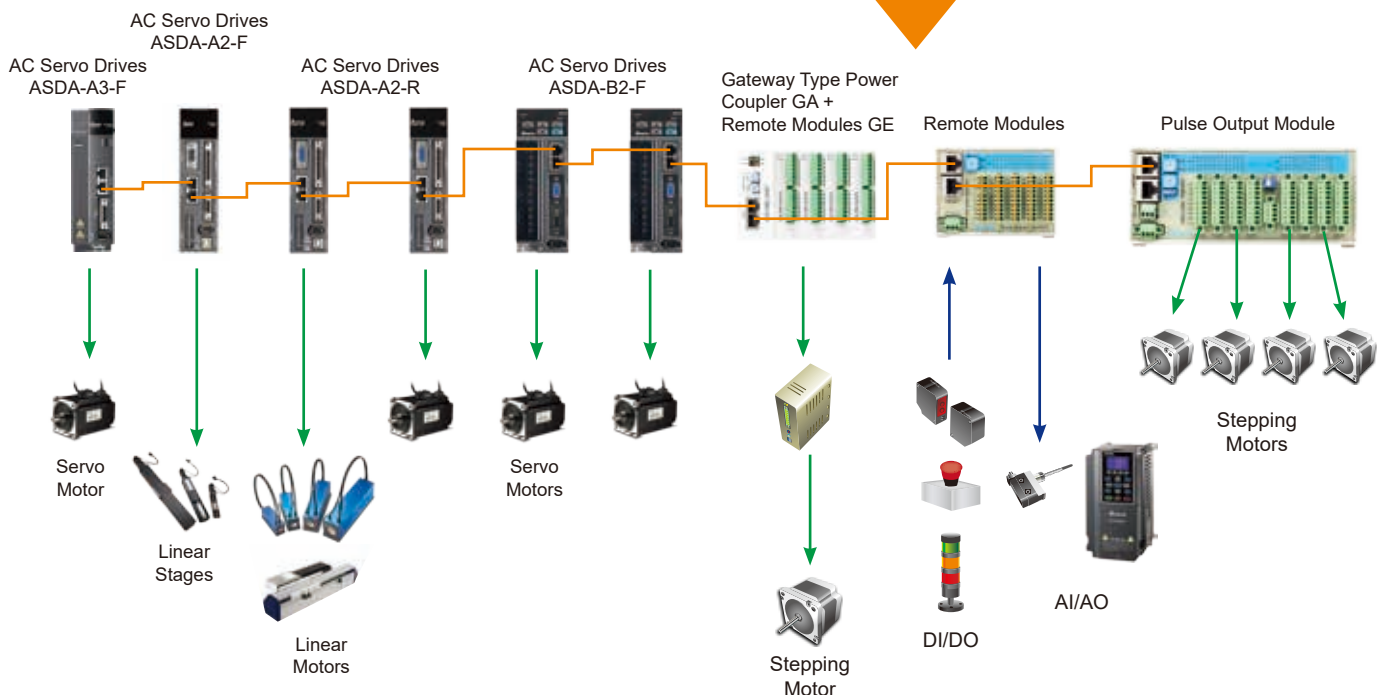
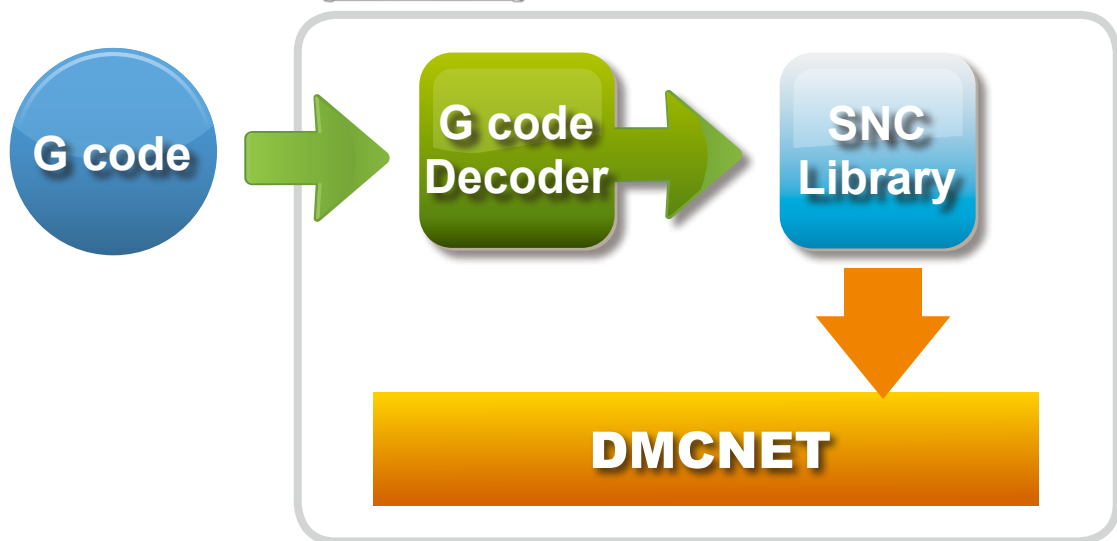

# Soft Numeric Control (SNC)

## SNC Software Structure with EtherCAT

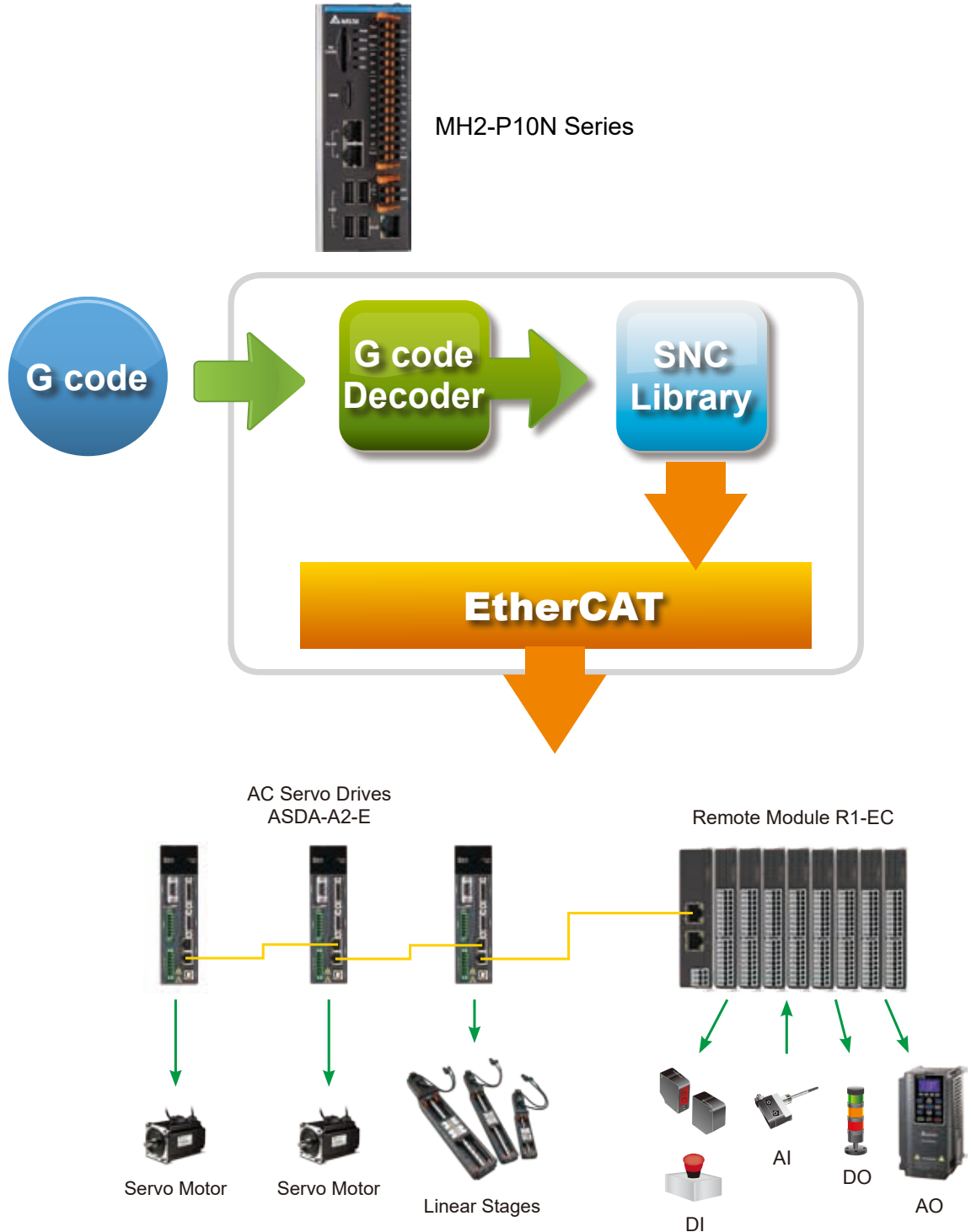



## Soft Numeric Control (SNC) Library

- The SNC Library offers abundant DLLs, including built-in G code decoder, Jerk control, S-curve smoothing, automatic corner deceleration, high speed multi-block look-ahead, curve fitting, tool management and other functions. It helps users develop user-defined NC programs through platforms such as BCB, C#, Delphi, VB, VB.Net, and VC.

### G code Decoder

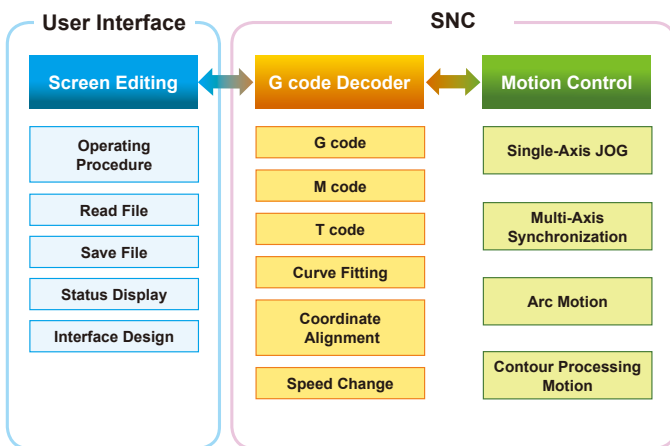

### Jerk Control

- When acceleration changes significantly, or the cutting path changes from a straight line to curve, the Jerk Control decelerates speed to suppress machine vibration and shock, and to maintain stability and precision for long term operation.

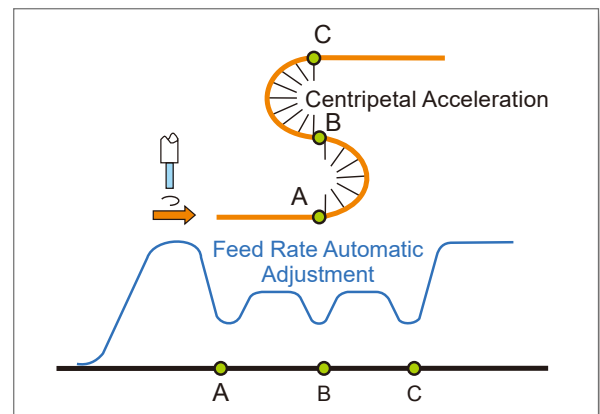

### S-Curve Smoothing

- The S-curve acceleration profile for smooth acceleration and deceleration before interpolation minimizes vibration and offers a stable and high-precision machining process.

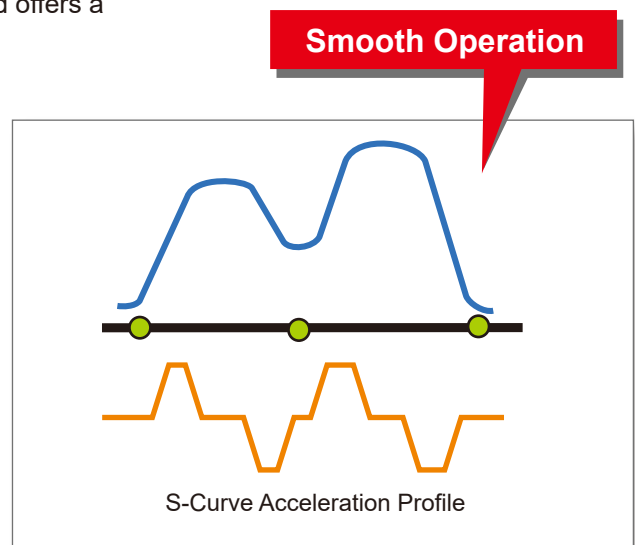
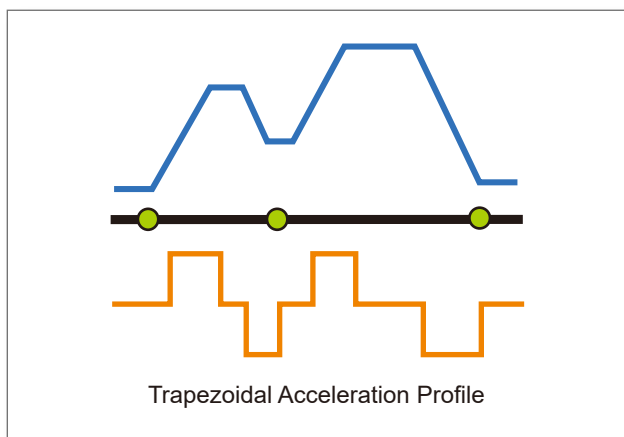

# Soft Numeric Control (SNC)

## Automatic Corner Deceleration

- During machining processes, corner deceleration is automatically calculated to help each axis maintain its precision and speed at corners and effectively smooth the process.

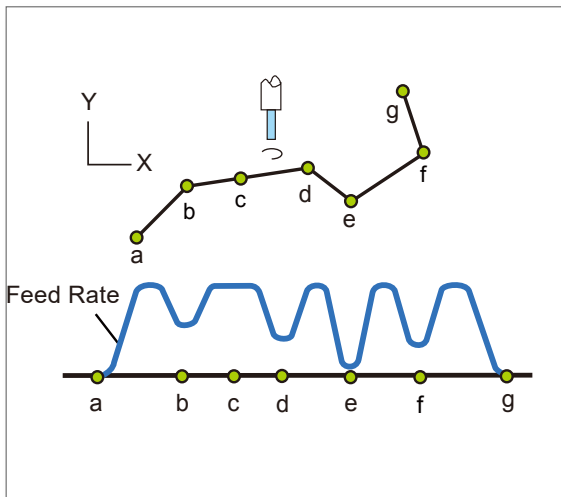

## Friction Compensation

- The servo drives provide real-time and smooth friction compensation with high sampling speed control loop for correcting the torque.

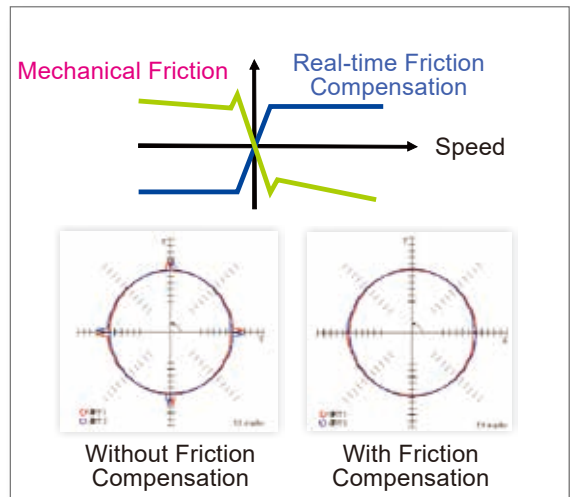

## Look-Ahead

- The look-ahead function performs processing operations according to the preset feed rate and path. This can efficiently reduce unnecessary deceleration and effectively increase production speed.

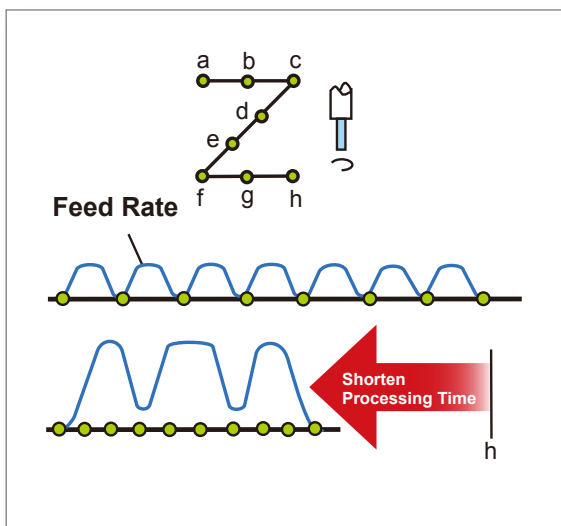

## Specific Line Number Execution

- When the machining is stopped by an incident, users can restart their program at a specified G code line number with breakpoint line number information to enhance processing efficiency.

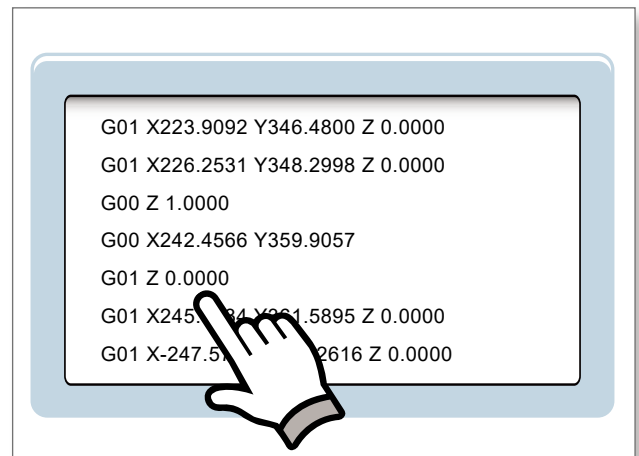

## Back and Release

- If there is a sudden stop due to incomplete workpieces cuts or insufficient oxy-fuel gas during laser and flame cutting, this function helps the tool move back to the intermediate point of the original processing path and continue processing.

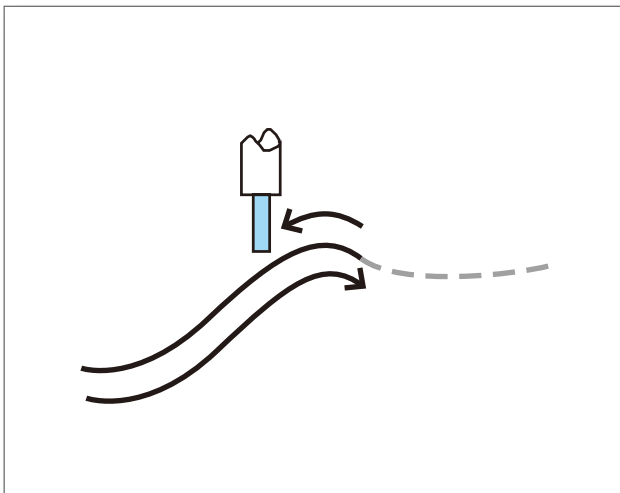

## Manual Pulse Generator (MPG) Simulation

- For first time CNC machining, the MPG simulation function can perform an exact simulation of the desired machining process under all operating conditions. It guarantees processing stability and eliminates problems with execution error or cutter / tool crashing while making processing safer and more accurate.



## Tool Management Function

- The tool management function provides functions such as setting tool numbers, resetting tool indexes, locking the desired tools, and setting numbers of the required cutters to prevent repeated usage and selecting the incorrect tool. The built-in carousel and armless modules also help speed up tool function setup.

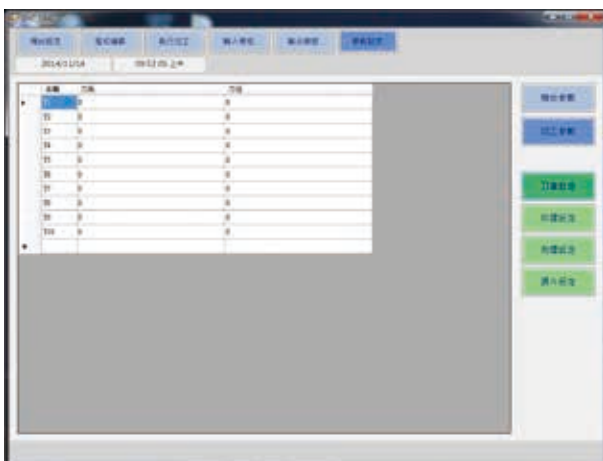

## Motion Graphical Functions

- The motion graphical functions capture the motion of a robot for optimizing motion control.



# Fieldbus Verification and Validation - EzDMC Software

EzDMC Software provides simple editing functions for all the relevant parameters of the fieldbus communication and facilitates easy configuration of program development and the hardware system. Even first time users of Delta's DMCNET motion control cards can utilize the motion control card functions.

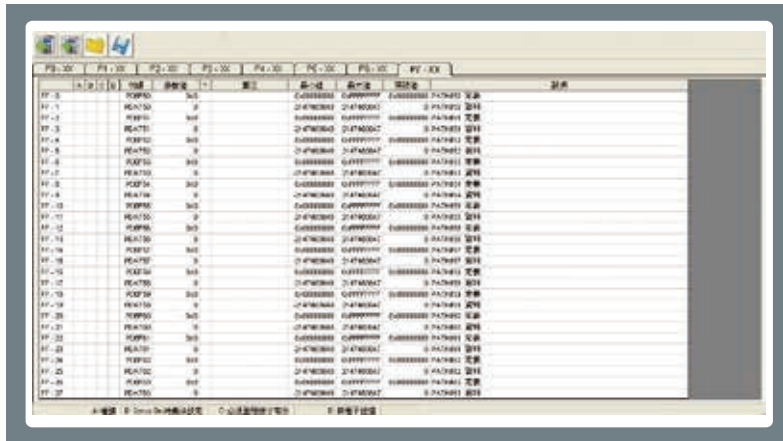

## ► User-Friendly Operator Interface

Helps users create and edit programs with clear images, easy-to-use parameter settings, and instruction disk for programming samples and function keys explanation

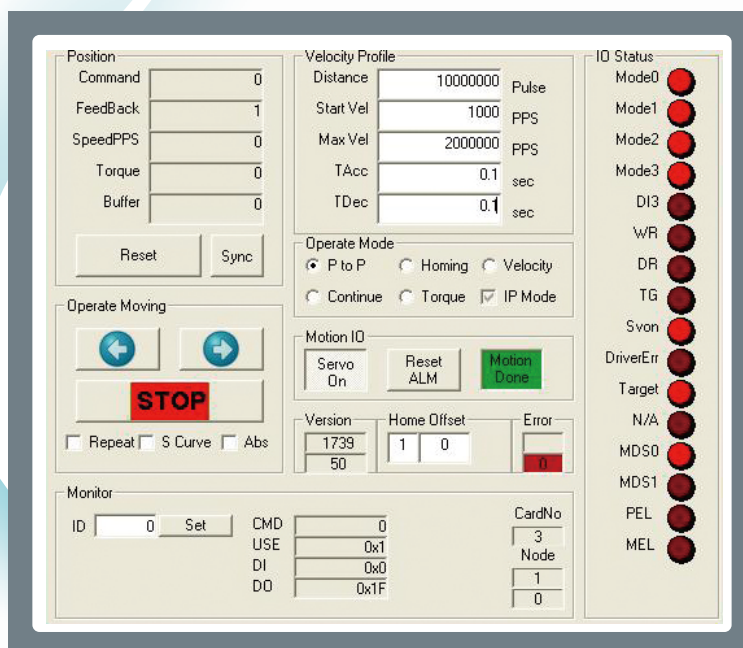
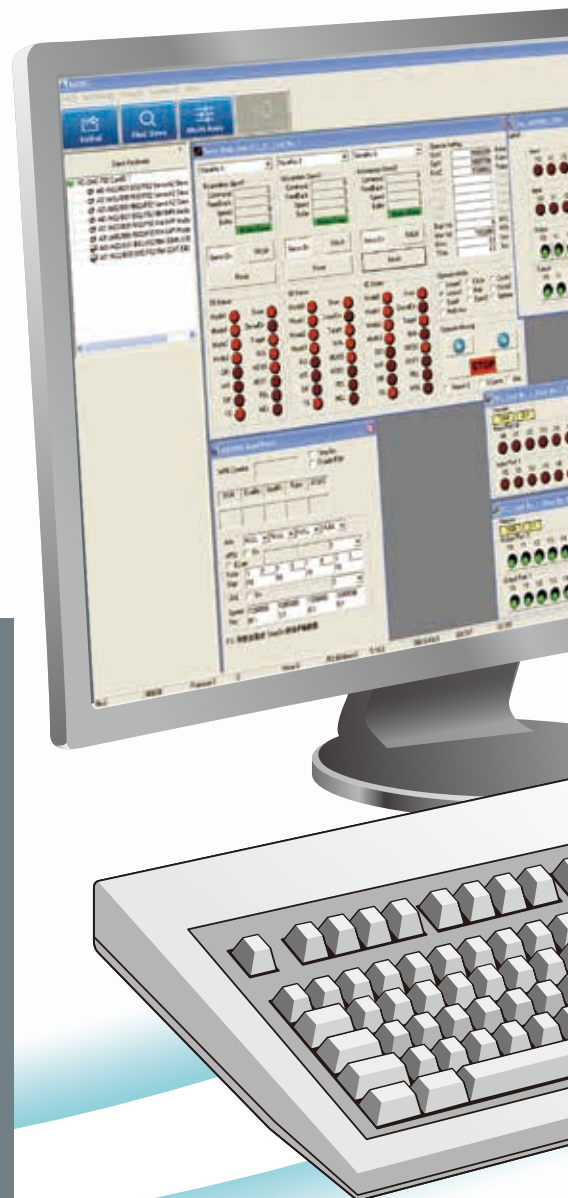

## ► Independent Control Unit

With the independent control unit, users can set up simple motions of the servo drives for flexible operation and management

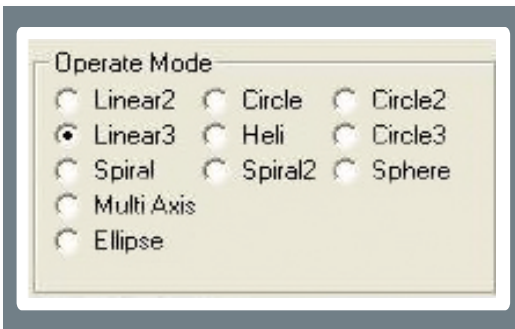

### ► Multi-Axis Motion Control Modes

Offers a variety of sample programs and control modes (e.g. Linear 2, Linear 3, Heli, Circle, Circle 2 and Circle 3) for linear, arc and helical interpolation to supervise various multi-axis motions and execute programming for multi-axis motion control applications

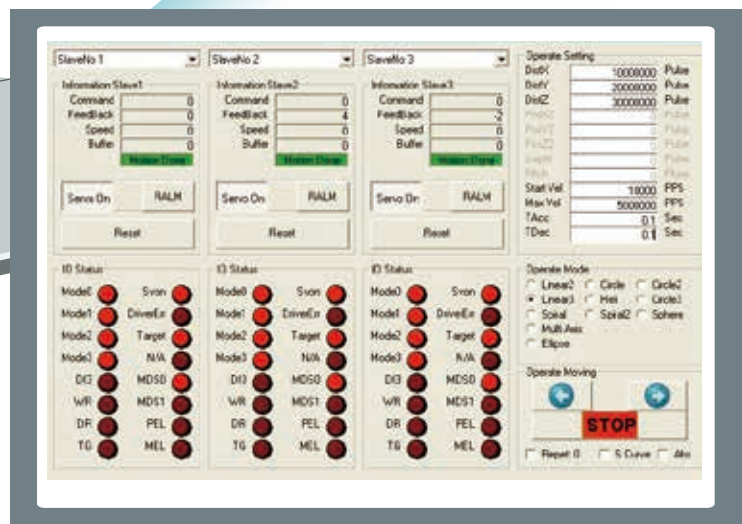
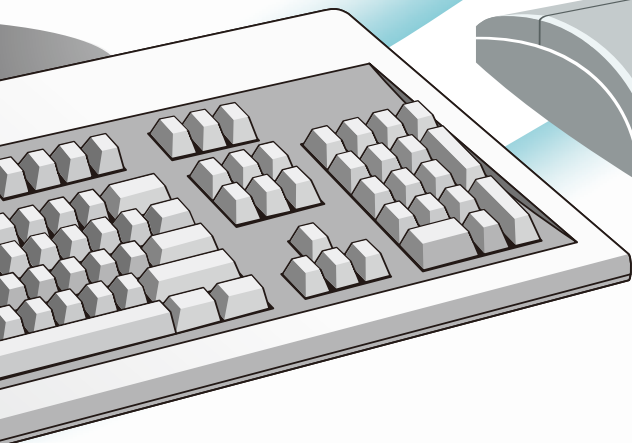

### ► Real-time Response and Feedback

Monitoring and displaying the status of the connected servo drives is completed in a timely and efficient manner

# EtherCAT System Configuration

## Motion Controllers

EtherCAT Motion Control Card

PAGE 35~40



PCIe-L221-B1D0

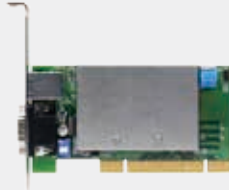

PCI-L221-P1D0



PCI-L221-B1D0

## Servo Systems

AC Servo Drive



ASDA-A2-E

PAGE 68

### Gateway Type Remote Modules

PAGE 61

Gateway Type E-Bus Remote Power Coupler



R1-EC5500D0 R1-EC5512D0

### Pulse Remote Module

1-Channel Pulse Remote Module



R1-EC5621D0

PAGE 62

### Digital Remote Modules

16 Digital Input Remote Module

R1-EC6002D0  
R1-EC6022D0

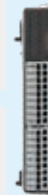

16 Digital Input Remote Module

R1-EC7062D0  
R1-EC70A2D0  
R1-EC70E2D0  
R1-EC70F2D0



PAGE 63~64

### Analog Remote Modules

4-Channel Analog Output Remote Module

R1-EC8124D0

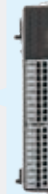

4-Channel Analog Output Remote Module

R1-EC9144D0

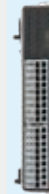

PAGE 65~66

### Functional Remote Modules

For Manual Pulse Generator (MPG)



R1-EC5614D0

PAGE 67

# High-Speed Motion Control System - EtherCAT Product Features

Ethernet Central Automation Technology (EtherCAT) is an open Ethernet-based fieldbus system that provides high-efficiency and high-performance synchronization quality for automation control. With EtherCAT, Delta's EtherCAT motion control card PCI-L221-P1 achieves rapid and real-time multiple axes of motion control, and is capable of controlling up to 100 slave stations that enable a 64-axis motion control within 1ms cycle time. It also provides 35 homing modes, point-to-point position control, 2-axis interpolation, 3-axis interpolation, multi-axis synchronization, continuous motion, gantry control, speed control, torque control and more. In addition, the IEC61131 is one of the optional functions for programming flexibility and scalability.

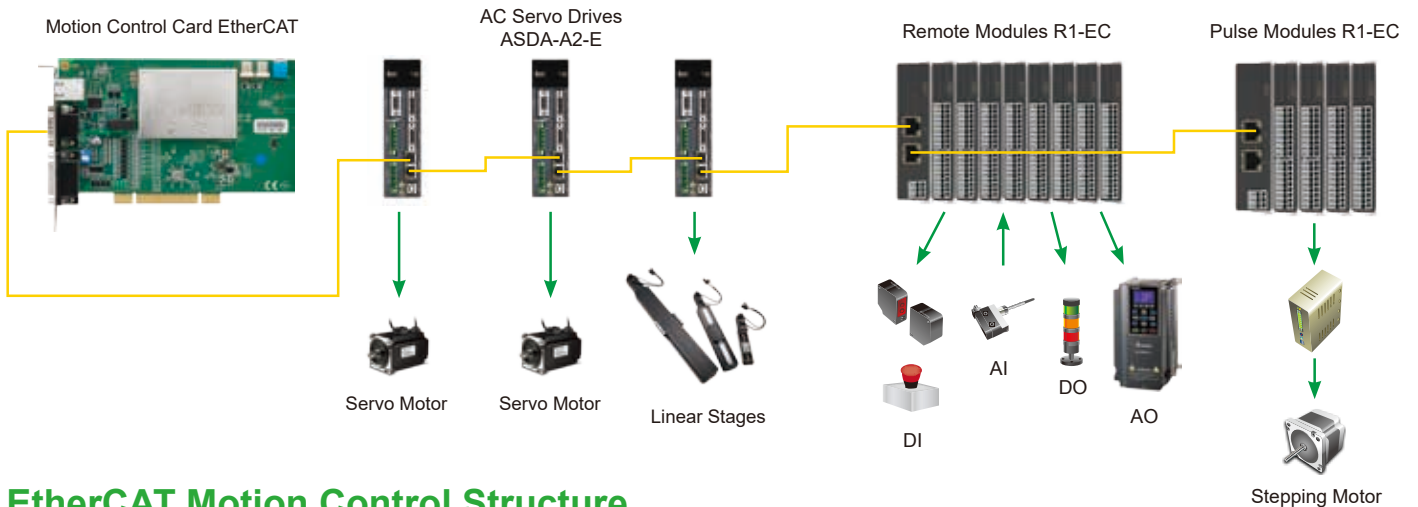

## EtherCAT Motion Control Structure

Delta provides a high-speed motion control card PCI-L221-XXD0 with complete functions for EtherCAT masters. Supporting device descriptions in XML format (EtherCAT Slave Information - ESI), the PCI-L221-XXD0 also allows the system to quickly identify ESI files and offers the capability of real-time connection via EtherCAT for high level integration. It can adjust the communication cycle time between stations within 1ms ~ 0.5 ms according to customer needs.

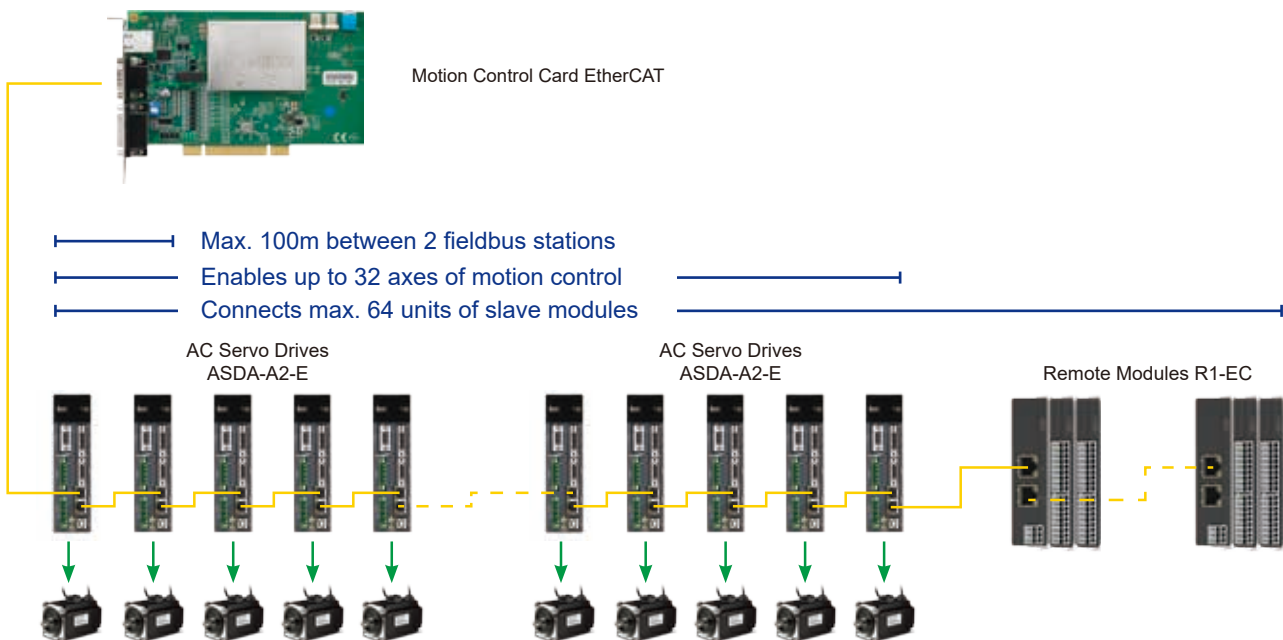

# Fieldbus Verification and Validation - EcNavi Software

EcNavi development software is for configuring an EtherCAT network that includes an EtherCAT master controller and slave devices for data communication, functional identification, programming and debugging. For new users of Delta's EtherCAT motion control, the EcNavi helps them become familiar with the configuration of the system and to complete the function verification and validation in real time.

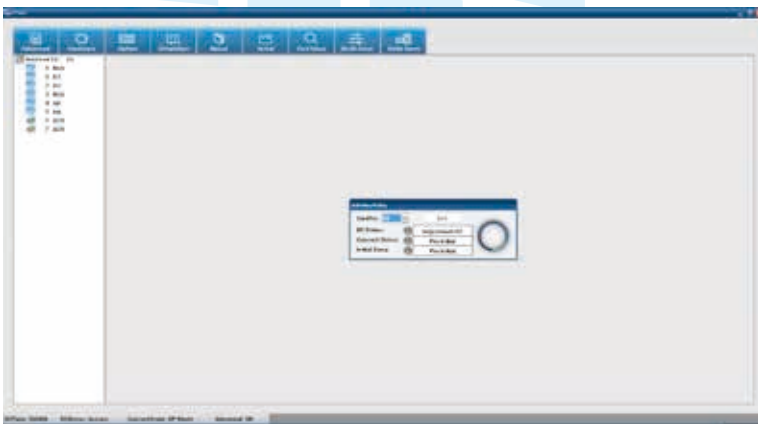

## ► Hardware Structure Search

Provides a search function for all slaves connected by EtherCAT to check hardware configuration and verify whether network communication is established successfully via software

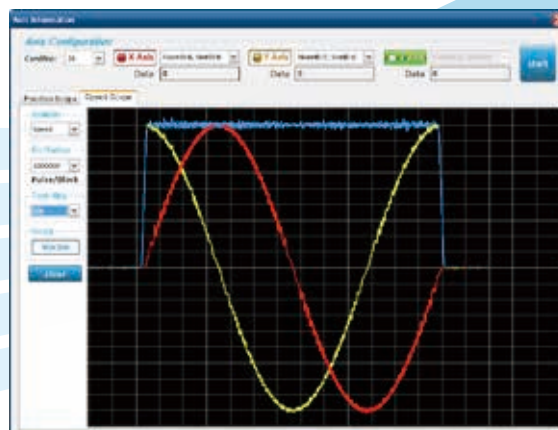

## ► Speed Curve Tracing

Offers real-time tracing for speed curves of current motion commands to achieve better synchronization effects between multiple axes

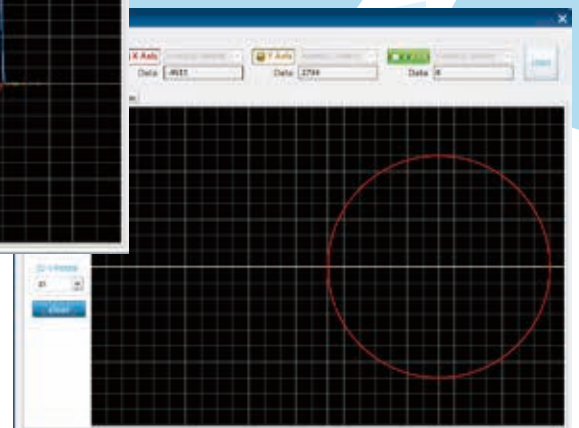





### ► Independent Control Unit

Helps users avoid writing complex programs and immediately verifies all motion commands with the servo drives to meet application requirements



### ► Multi-Axis Motion Control Mode

Offers a variety of sample programs and control modes for EtherCAT devices (e.g. Linear 2, Linear 3, Heli, Circle, Circle 2 and Circle 3) to help users easily edit and complete development programs for multi-axis motion control applications

# DMCNET Motion Control Card

- **Standard Type PCI-DMC-A02**

## Specifications

Model Name	PCI-DMC-A02
Supporting Module	Delta Servo Drive ASDA-A2-F / ASDA-B2-F Series
Homing Mode	35 types (Parameter Setting via DMCNET)
Velocity Profiles	T-curve, S-curve
Interpolation Mode	Linear, Arc, Helical and Continuous
Ring	1 Ring
Supporting Languages	VB, VC, BCB, Delphi, C#, VB.NET, Labview
Communication Cable	Category 5e STP Ethernet Cable (24AWG / 4Pairs)
Communication Distance	Max. 30m (12 slave modules)
Communication Interface	Half duplex RS-485 with transformer isolation
PCI Specifications	ver.2.2, supports 32-bit, 3.3 V / 5 V <sub>DC</sub> operation
Power Consumption	+5V DC at 1A typical
Environment	Operating Temperature: 0°C ~ 50°C ; Storage Temperature: -20°C ~ 70°C Humidity: 5 ~ 95% (non-condensing)
Maximum Axes	12
Maximum Number of Modules	12
Digital Input	32-CH isolated, SINK/SOURCE type, 24 V <sub>DC</sub> (5mA/CH)
Digital Output	24-CH isolated, SINK type, 24 V <sub>DC</sub> (100mA/CH)
Noise Tolerance	Withstand (Peak) voltage: 1500V <sub>AC</sub> (Primary-secondary); 1500V <sub>AC</sub> (Primary-PE) ESD (IEC 61131-2, IEC 61000-4-2): 8 KV Air Discharge EFT (IEC 61131-2, IEC 61000-4-4): Power Line: 2KV, Communication I/O: 1KV RS (IEC 61131-2, IEC 61000-4-3): 26MHz ~ 1GHz, 10V/m

## Exterior of the Motion Control Card

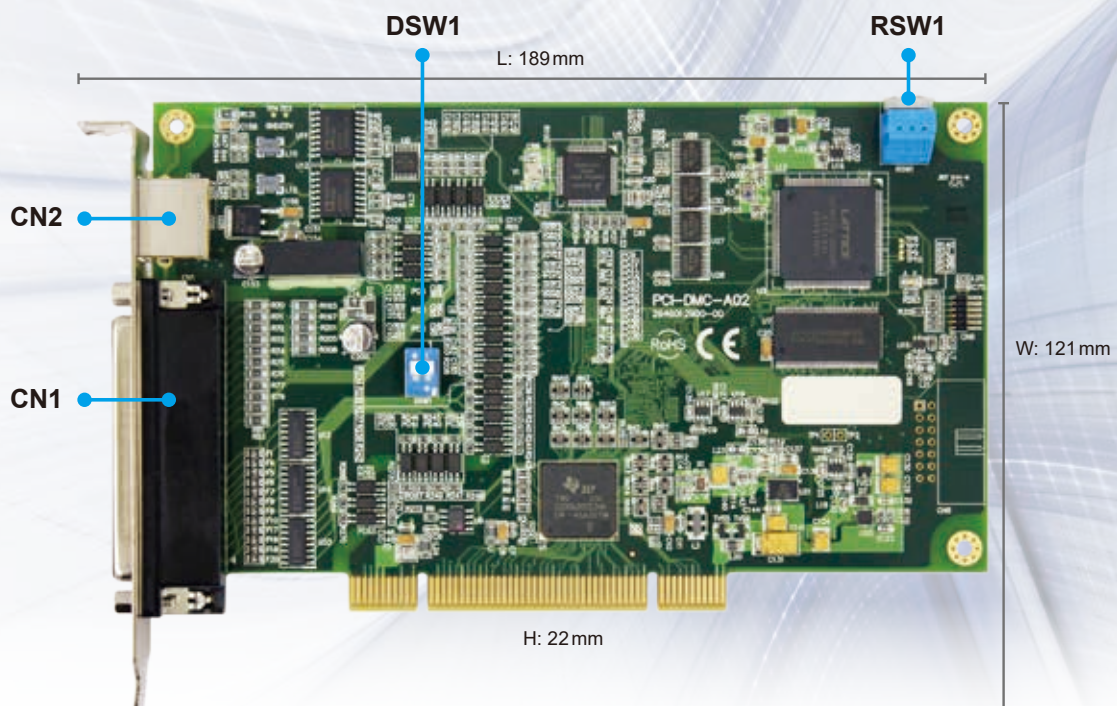

Title	Function
CN1	Digital Input / Output Connector
CN2	DMCNET Expansion Module Connection Port
RSW1	Card ID Number Configuration Switch
DSW1	Input / Output Signal SINK / SOURCE Device Switch

- CN1: Digital Input / Output Connector**

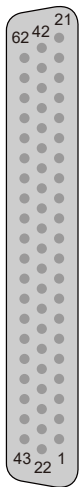

PIN	Description	PIN	Description	PIN	Description
1	GPIO Output Signal 7	22	GPIO Output Signal 16	43	GPIO Output Signal 23
2	GPIO Output Signal 6	23	GPIO Output Signal 15	44	GPIO Output Signal 22
3	GPIO Output Signal 5	24	GPIO Output Signal 14	45	GPIO Output Signal 21
4	GPIO Output Signal 4	25	GPIO Output Signal 13	46	GPIO Output Signal 20
5	GPIO Output Signal 3	26	GPIO Output Signal 12	47	GPIO Output Signal 19
6	GPIO Output Signal 2	27	GPIO Output Signal 11	48	GPIO Output Signal 18
7	GPIO Output Signal 1	28	GPIO Output Signal 10	49	GPIO Output Signal 17
8	GPIO Output Signal 0	29	GPIO Output Signal 9	50	24V <sub>DC</sub> Power
9	GND Signal	30	GPIO Output Signal 8	51	EGND Signal
10	GND Signal	31	GND Signal	52	GPIO Input Signal 31
11	GPIO Input Signal 10	32	GND Signal	53	GPIO Input Signal 30
12	GPIO Input Signal 9	33	GPIO Input Signal 20	54	GPIO Input Signal 29
13	GPIO Input Signal 8	34	GPIO Input Signal 19	55	GPIO Input Signal 28
14	GPIO Input Signal 7	35	GPIO Input Signal 18	56	GPIO Input Signal 27
15	GPIO Input Signal 6	36	GPIO Input Signal 17	57	GPIO Input Signal 26
16	GPIO Input Signal 5	37	GPIO Input Signal 16	58	GPIO Input Signal 25
17	GPIO Input Signal 4	38	GPIO Input Signal 15	59	GPIO Input Signal 24
18	GPIO Input Signal 3	39	GPIO Input Signal 14	60	GPIO Input Signal 23
19	GPIO Input Signal 2	40	GPIO Input Signal 13	61	GPIO Input Signal 22
20	GPIO Input Signal 1	41	GPIO Input Signal 12	62	GPIO Input Signal 21
21	GPIO Input Signal 0	42	GPIO Input Signal 11		

- CN2: DMCNET Expansion Module Connection Port**

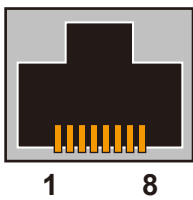

PIN	Label	Description
1	RS485T_1 (+)	1st RS485 Transmission Signal (+)
2	RS485T_1 (-)	1st RS485 Transmission Signal (-)
3	RS485T_2 (+)	2nd RS485 Transmission Signal (+)
6	RS485T_2 (-)	2nd RS485 Transmission Signal (-)
7	EGND	9V Ground Signal
8	EGND	9V Ground Signal

- DSW1: SINK / SOURCE Loop Switch**

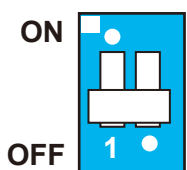

Label	Description
ON	SOURCE (connects to PNP device)
OFF	SINK (connects to NPN device)

- RSW1: Dial for Setting the Card ID Number**

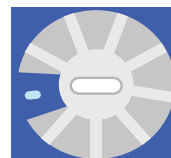

The number is set based on the value of the dial (between 0 ~ 15)

# DMCNET Motion Control Card

- Advanced Type PCI-DMC-B01

## Specifications

Model Name	PCI-DMC-B01
Supporting Module	Delta Servo Drive ASDA-A3-F / ASDA-A2-F / ASDA-B2-F Series
Homing Mode	35 types (Parameter Setting via DMCNET)
Velocity Profiles	T-curve, S-curve
Interpolation Mode	Linear, Arc, Helical and Continuous
Ring	1 Ring
Supporting Languages	VB, VC, BCB, Delphi, C#, VB.NET, Labview
Communication Cable	Category 5e STP Ethernet Cable (24AWG/4Pairs)
Communication Distance	Max. 30 m (12 slave modules)
Communication Interface	Half duplex RS-485 with transformer isolation
PCI Specifications	ver.2.2, supports 32-bit, 3.3 V / 5 V <sub>DC</sub> operation
Power Consumption	+5 V <sub>DC</sub> at 0.5 A typical
Environment	Operating Temperature: 0°C ~ 50°C; Storage Temperature: -20°C ~ 70°C Humidity: 5 ~ 95% (Non-condensing)
Maximum Axes	12
Maximum Number of Modules	12
Digital Input	1-CH isolated, SINK/SOURCE type, 24VDC (5mA/CH)
Digital Output	1-CH isolated, SINK type, 24V <sub>DC</sub> (100mA/CH)
Encoder Input	2-CH isolated, EA± / EB±
Compare Signal Output	2-CH single-ended high speed compare, CMP, Max: 200K 2-CH differential table compare, CMP±, Max: 3.6K
Noise Tolerance	Withstand (Peak) Voltage: 1500V <sub>AC</sub> (Primary-secondary); 1500V <sub>AC</sub> (Primary-PE) ESD (IEC 61131-2, IEC 61000-4-2): 8KV Air Discharge EFT (IEC 61131-2, IEC 61000-4-4): Power Line: 2KV, Communication I/O: 1KV RS (IEC 61131-2, IEC 61000-4-3): 26MHz ~ 1GHz, 10V/m

## Exterior of the Motion Control Card

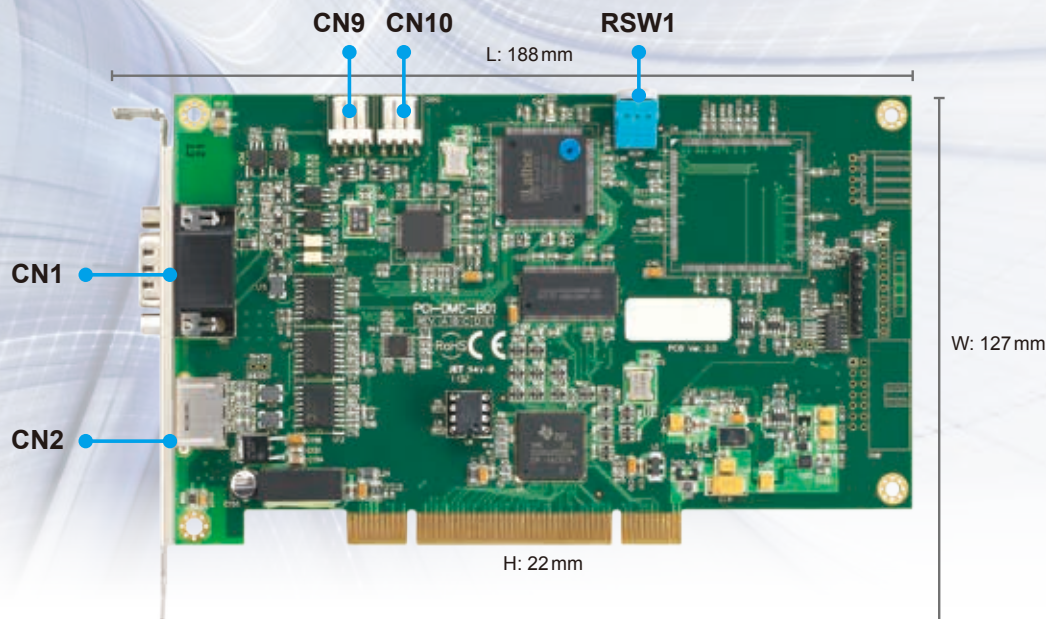

Title	Function
CN1	Connector (digital input/output, encoder & compare)
CN2	DMCNET Expansion Module Connection Port
CN9	Position compare signal output (channel 1, 3.3V)
CN10	Position compare signal output (channel 1, 3.3V)
RSW1	Card ID Number Configuration Switch

## ● CN1: Digital Input / Output

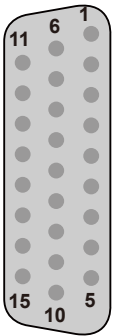

PIN	Label	Description	PIN	Label	Description
1	QA_1-	QA Signal 1 (-)	9	QB_2+	QB Signal 2 (+)
2	QB_1-	QB Signal 1 (-)	10	GPIO IN	GPIO Input Signal
3	QA_2-	QA Signal 2 (-)	11	CMP_1+(RS-422)	1st RS422 Differential Signal (+)
4	QB_2-	QB Signal 2 (-)	12	CMP_1- (RS-422)	1st RS422 Differential Signal (-)
5	External GND	GND Signal	13	CMP_2+(RS-422)	2nd RS422 Differential Signal (+)
6	QA_1+	QA Signal 1 (+)	14	CMP_2- (RS-422)	2nd RS422 Differential Signal (-)
7	QB_1+	QB Signal 1 (+)	15	GPIO OUT	GPIO Output signal
8	QA_2+	QA Signal 2 (+)			GPIO: General Purpose Input & Output

## ● CN2: DMCNET Expansion Module Connection Port

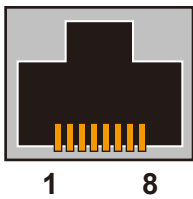

PIN	Label	Description
1	RS485T_1 (+)	1st RS485 transmission signal (+)
2	RS485T_1 (-)	1st RS485 transmission signal (-)
3	RS485T_2 (+)	2nd RS485 transmission signal (+)
6	RS485T_2 (-)	2nd RS485 transmission signal (-)
7	EGND	9V Ground Signal
8	EGND	9V Ground Signal

## ● CN9: 3.3V Compare Output 1 ● CN10: 3.3V Compare Output 2

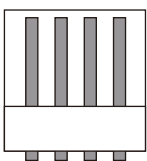

PIN	Label	Description	PIN	Label	Description
1	CMP_OUT1(QEP1)	CMOS 3.3V to level comparison trigger signal output	1	CMP_OUT2(QEP2)	CMOS 3.3V to level comparison trigger signal output
2	GND	GND Signal	2	GND	GND Signal
3	CMP_1+(LVDS)	LVDS Differential Signal (+)	3	CMP_2+(LVDS)	LVDS Differential Signal (+)
6	CMP_1- (LVDS)	LVDS Differential Signal (-)	6	CMP_2- (LVDS)	LVDS Differential Signal (-)

## ● RSW1: Dial for Setting the Card ID Number

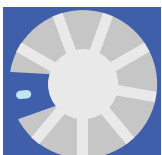

The number is set based on the value of the dial (between 0 ~ 15)

# DMCNET Motion Control Card

- Advanced Type PCI-DMC-B02

## Specifications

Model Name	PCI-DMC-B02
Supporting Module	Delta Servo Drive ASDA-A3-F / ASDA-A2-F / ASDA-B2-F
Homing Module	35 types (Parameter setting via DMCNET)
Velocity Profiles	T-curve, S-curve
Interpolation Mode	Linear, Arc, Helical and Continuous
Ring	1 Ring
Supporting Languages	VB, VC, BCB, Delphi, C#, VB.NET, Labview
Communication Cable	Category 5e STP Ethernet Cable (24 AWG / 4 Pairs)
Communication Distance	Max. 30m (12 slave modules)
Communication Interface	Half duplex RS-485 with transformer isolation
PCI Specifications	ver. 2.2; supports 32-bit, 3.3V / 5VDC operation
Power Consumption	+5V <sub>DC</sub> at 1A typical
Environment	Operating Temperature: 0°C ~ 50°C ; Storage Temperature: -20°C ~ 70°C Humidity: 5 ~ 95% RH(Non-condensing)
Maximum Axes	12
Maximum Number of Modules	12
Digital Input	8-CH isolated, SINK/SOURCE type, 24V <sub>DC</sub> (5mA/CH)
Digital Output	4-CH isolated, SINK, 24V <sub>DC</sub> (100mA/CH)
Encoder Input	3-CH isolated, EA± / EB±
Compare Signal Output	4-CH single-ended high-speed compare, CMP, Max: 40K 6-CH differential table compare, CMP±, Max: 40K
Noise Tolerance	Withstand (Peak) Voltage: 1500V <sub>AC</sub> (Primary-secondary); 1500V <sub>AC</sub> (Primary-PE) ESD (IEC 61131-2, IEC61000-4-2): 8KV Air Discharge EST (IEC 61131-2, IEC61000-4-4): Power Line: 2KV, Communication I/O: 1KV RS (IEC 61131-2, IEC61000-4-3): 26MHz ~ 1GHz, 10V/m

## Exterior of the Motion Control Card

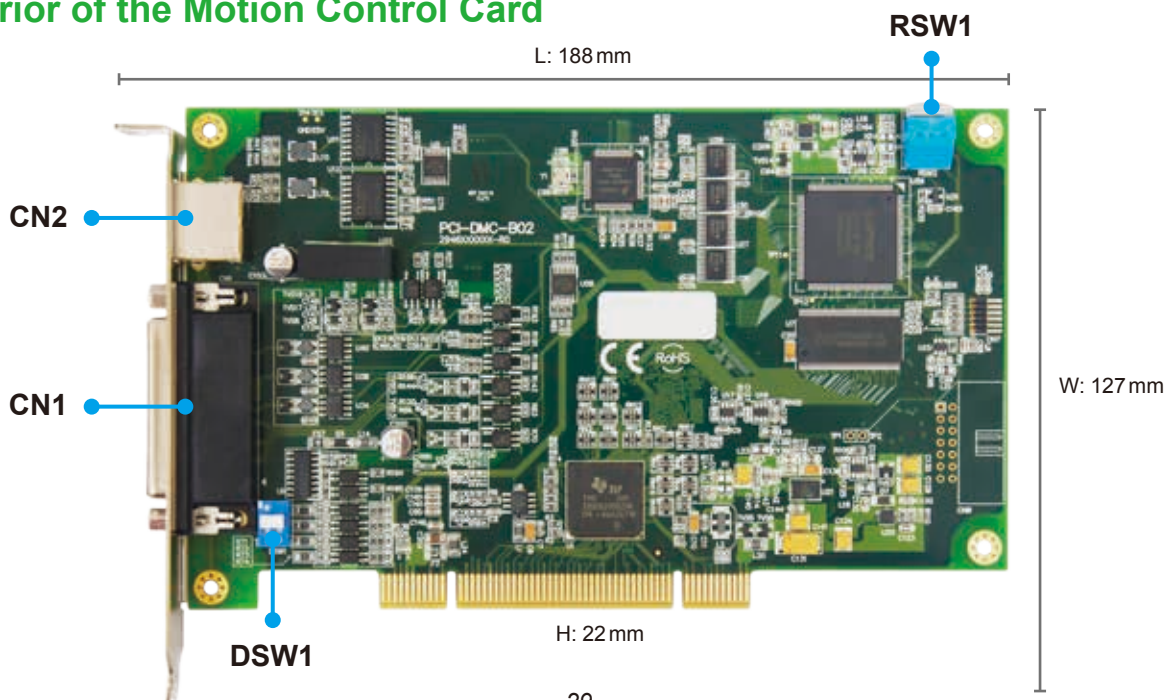

Title	Function
CN1	Connector (digital input/output, encoder & compare)
CN2	DMCNET Expansion Module Connection Port
RSW1	Card ID Number Configuration Switch
DSW1	Input / Output Signal SINK / SOURCE Device Switch

## ● CN1: Digital Input / Output

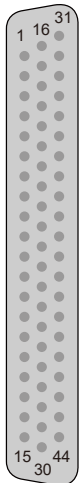

PIN	Description	PIN	Description	PIN	Description
1	QA_1-	16	QA_1+	0	IN_1
2	QB_1-	17	QB_1+	32	IN_2
3	QA_2-	18	QA_2+	33	IN_3
4	QB_2-	19	QB_2+	34	IN_4
5	QA_3-	20	QA_3+	35	IN_5
6	QB_3-	21	QB_3+	36	IN_6
7	CMP_1-	22	CMP_1+	37	IN_7
8	CMP_2-	23	CMP_2+	38	IN_8
9	CMP_3-	24	CMP_3+	39	OUT_1
10	CMP_4-	25	CMP_4+	40	OUT_2
11	CMP_5-	26	CMP_5+	41	OUT_3
12	CMP_6-	27	CMP_6+	42	OUT_4
13	CMP_7	28	CMP_8	43	E24V
14	CMP_9	29	CMP_10	44	E24V
15	EGND	30	EGND		

## ● CN2: DMCNET Expansion Module Connection Port

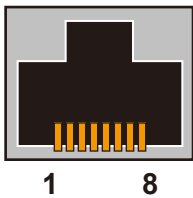

PIN	Label	Description
1	RS485T_1 (+)	1st RS485 Transmission Signal (+)
2	RS485T_1 (-)	1st RS485 Transmission Signal (-)
3	RS485T_2 (+)	2nd RS485 Transmission Signal (+)
6	RS485T_2 (-)	2nd RS485 Transmission Signal (-)
7	EGND	9V Ground Signal
8	EGND	9V Ground Signal

## ● RSW1: Dial for Setting the Card ID Number

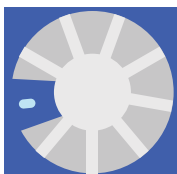

The number is set based on the value of the dial (between 0 ~ 15)

## ● DSW1: SINK / SOURCE Loop Switch

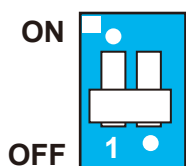

Label	Description
ON	SOURCE (connects to PNP device)
OFF	SINK (connects to NPN device)

# DMCNET Motion Control Card

- Advanced Type PCI-DMC-B03

## Specifications

Model Name	PCI-DMC-B03
Supporting Module	Delta Servo Drive ASDA-A3-F / ASDA-A2-F / ASDA-B2-F
Homing Module	35 types (Parameter setting via DMCNET)
Velocity Profiles	T-curve, S-curve
Interpolation Mode	Linear, Arc, Helical and Continuous
Ring	1 Ring
Supporting Languages	VB, VC, BCB, Delphi, C#, VB.NET, Labview
Communication Cable	Category 5e STP Ethernet Cable (24 AWG / 4 Pairs)
Communication Distance	Max. 30m (12 slave modules)
Communication Interface	Half duplex RS-485 with transformer isolation
PCI Specifications	ver. 2.2; supports 32-bit, 3.3V / 5VDC operation
Power Consumption	+5V <sub>DC</sub> at 1A typical
Environment	Operating Temperature: 0°C ~ 50°C ; Storage Temperature: -20°C ~ 70°C Humidity: 5 ~ 95% RH (Non-condensing)
Maximum Axes	12
Maximum Number of Modules	12
Digital Input	8-CH isolated, SINK/SOURCE type, 24V <sub>DC</sub> (5mA/CH)
Digital Output	4-CH isolated, SINK, 24V <sub>DC</sub> (100mA/CH)
Encoder Input	3-CH isolated, EA± / EB±
Compare Signal Output	4-CH single-ended high-speed compare, CMP, Max: 100K 6-CH differential table compare, CMP±, Max: 3K
Noise Tolerance	Withstand (Peak) Voltage: 1500V <sub>AC</sub> (Primary-secondary); 1500V <sub>AC</sub> (Primary-PE) ESD (IEC 61131-2, IEC61000-4-2): 8KV Air Discharge EST (IEC 61131-2, IEC61000-4-4): Power Line: 2KV, Communication I/O: 1KV RS (IEC 61131-2, IEC61000-4-3): 26MHz ~ 1GHz, 10V/m

## Exterior of the Motion Control Card

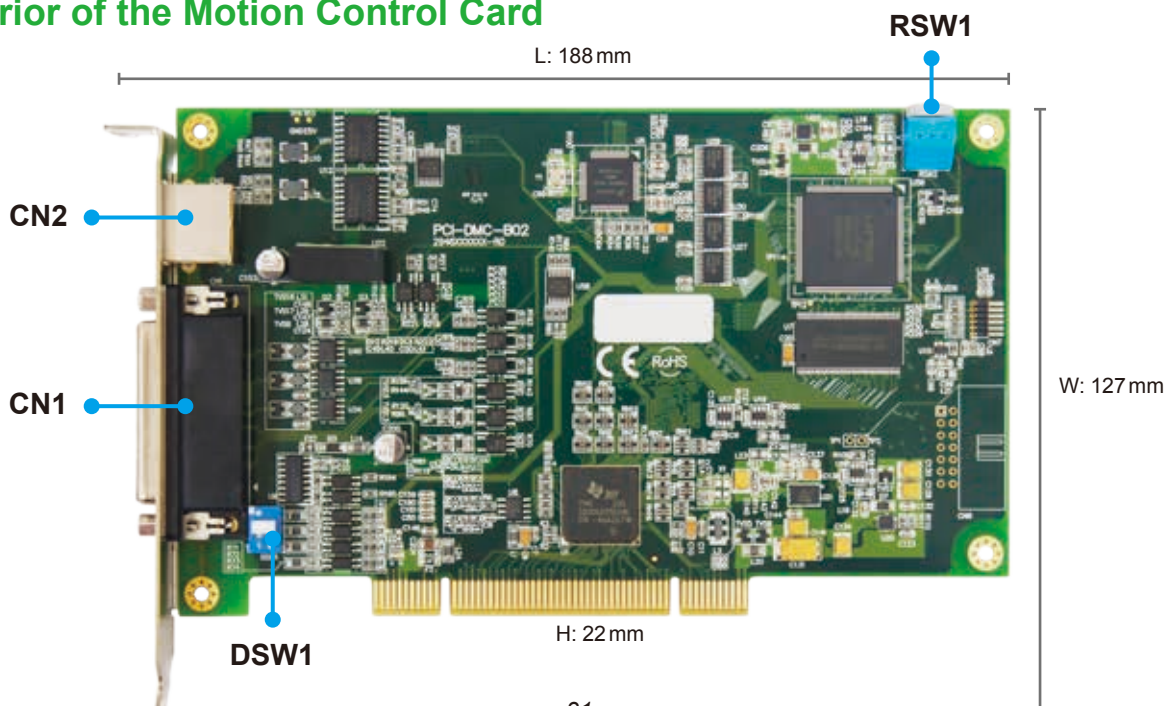



Title	Function
CN1	Connector (digital input/output, encoder & compare)
CN2	DMCNET Expansion Module Connection Port
RSW1	Card ID Number Configuration Switch
DSW1	Input / Output Signal SINK / SOURCE Device Switch

## ● CN1: Digital Input / Output

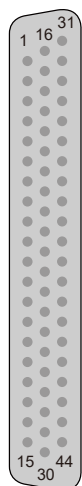

PIN	Description	PIN	Description	PIN	Description
1	QA_1-	16	QA_1+	0	IN_1
2	QB_1-	17	QB_1+	32	IN_2
3	QA_2-	18	QA_2+	33	IN_3
4	QB_2-	19	QB_2+	34	IN_4
5	QA_3-	20	QA_3+	35	IN_5
6	QB_3-	21	QB_3+	36	IN_6
7	CMP_1-	22	CMP_1+	37	IN_7
8	CMP_2-	23	CMP_2+	38	IN_8
9	CMP_3-	24	CMP_3+	39	OUT_1
10	CMP_4-	25	CMP_4+	40	OUT_2
11	CMP_5-	26	CMP_5+	41	OUT_3
12	CMP_6-	27	CMP_6+	42	OUT_4
13	CMP_7	28	CMP_8	43	E24V
14	CMP_9	29	CMP_10	44	E24V
15	EGND	30	EGND		

## ● CN2: DMCNET Expansion Module Connection Port

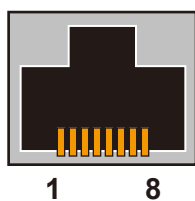

PIN	Label	Description
1	RS485T_1 (+)	1st RS485 Transmission Signal (+)
2	RS485T_1 (-)	1st RS485 Transmission Signal (-)
3	RS485T_2 (+)	2nd RS485 Transmission Signal (+)
6	RS485T_2 (-)	2nd RS485 Transmission Signal (-)
7	EGND	9V Ground Signal
8	EGND	9V Ground Signal

## ● RSW1: Dial for Setting the Card ID Number



The number is set based on the value of the dial (between 0 ~ 15)

## ● DSW1: SINK / SOURCE Loop Switch

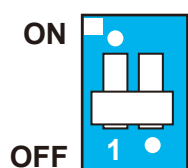

Label	Description
ON	SOURCE (connects to PNP device)
OFF	SINK (connects to NPN device)

# DMCNET Motion Control Card

- Economical Type PCI-DMC-F02

## Specifications

Model Name	PCI-DMC-F02
Supporting Module	Delta Servo Drive ASDA-A2-F / ASDA-B2-F Series
Homing Mode	35 types (Parameter Setting via DMCNET)
Velocity Profiles	T-curve, S-curve
Interpolation Mode	Linear, Arc, Helical and Continuous
Ring	1 Ring
Supporting Languages	VB, VC, BCB, Delphi, C#, VB.NET
Communication Cable	Category 5e STP Ethernet cable (24AWG/4 Paris)
Communication Distance	Max. 30 m (12 slave modules)
Communication Interface	Half duplex RS-485 with transformer isolation
PCI Specifications	ver.2.2, supports 32-bit, 3.3 V / 5 V <sub>DC</sub> operation
Power Consumption	+5V <sub>DC</sub> at 0.5A typical
Environment	Operating Temperature: 0°C ~ 50°C; Storage Temperature: -20°C ~ 70°C Humidity: 5 ~ 95% (Non-condensing)
Maximum Axes	6
Maximum Number of Modules	12
Digital Input	32-CH isolated, SINK/SOURCE type, 24V <sub>DC</sub> (5mA/CH)
Digital Output	24-CH isolated, SINK type, 24V <sub>DC</sub> (100mA/CH)
Noise Tolerance Threshold	Withstand (Peak) Voltage: 1500 V <sub>AC</sub> (Primary-secondary); 1500 V <sub>AC</sub> (Primary-PE) ESD (IEC 61131-2, IEC61000-4-2): 8 KV Air Discharge EST (IEC 61131-2, IEC61000-4-4): Power Line: 2KV, Communication I/O: 1KV RS (IEC 61131-2, IEC61000-4-3): 26MHz ~ 1GHz, 10V/m

## Exterior of the Motion Control Card

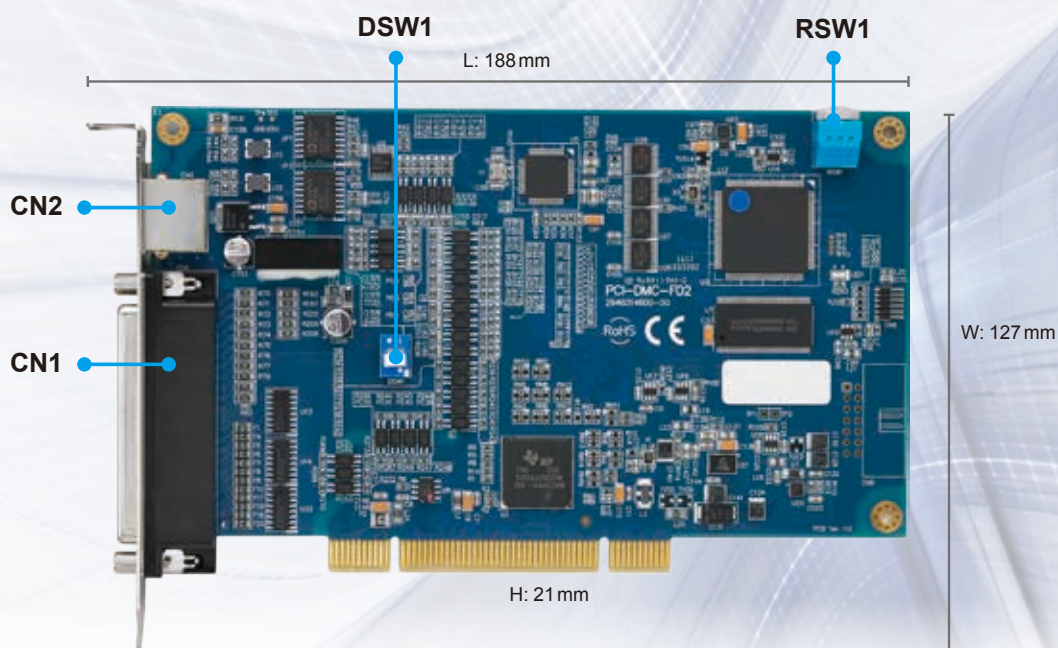

Title	Function
CN1	Digital Input/Output Connector
CN2	DMCNET Expansion Module Connection Port
RSW1	Card ID Number Configuration Switch
DSW1	Input / Output Signal SINK/SOURCE Device Switch

- CN1: Digital Input / Output Connector**

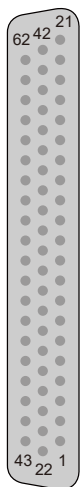

PIN	Description	PIN	Description	PIN	Description
1	GPIO Output Signal 7	22	GPIO Output Signal 16	43	GPIO Output Signal 23
2	GPIO Output Signal 6	23	GPIO Output Signal 15	44	GPIO Output Signal 22
3	GPIO Output Signal 5	24	GPIO Output Signal 14	45	GPIO Output Signal 21
4	GPIO Output Signal 4	25	GPIO Output Signal 13	46	GPIO Output Signal 20
5	GPIO Output Signal 3	26	GPIO Output Signal 12	47	GPIO Output Signal 19
6	GPIO Output Signal 2	27	GPIO Output Signal 11	48	GPIO Output Signal 18
7	GPIO Output Signal 1	28	GPIO Output Signal 10	49	GPIO Output Signal 17
8	GPIO Output Signal 0	29	GPIO Output Signal 9	50	24V <sub>DC</sub> Power
9	GND Signal	30	GPIO Output Signal 8	51	EGND Signal
10	GND Signal	31	GND Signal	52	GPIO Input Signal 31
11	GPIO Input Signal 10	32	GND Signal	53	GPIO Input Signal 30
12	GPIO Input Signal 9	33	GPIO Input Signal 20	54	GPIO Input Signal 29
13	GPIO Input Signal 8	34	GPIO Input Signal 19	55	GPIO Input Signal 28
14	GPIO Input Signal 7	35	GPIO Input Signal 18	56	GPIO Input Signal 27
15	GPIO Input Signal 6	36	GPIO Input Signal 17	57	GPIO Input Signal 26
16	GPIO Input Signal 5	37	GPIO Input Signal 16	58	GPIO Input Signal 25
17	GPIO Input Signal 4	38	GPIO Input Signal 15	59	GPIO Input Signal 24
18	GPIO Input Signal 3	39	GPIO Input Signal 14	60	GPIO Input Signal 23
19	GPIO Input Signal 2	40	GPIO Input Signal 13	61	GPIO Input Signal 22
20	GPIO Input Signal 1	41	GPIO Input Signal 12	62	GPIO Input Signal 21
21	GPIO Input Signal 0	42	GPIO Input Signal 11		

- CN2: DMCNET Expansion Module Connection Port**

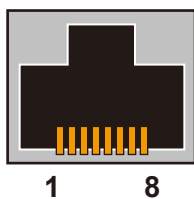

PIN	Label	Description
1	RS485T_1 (+)	1st RS485 Transmission Signal (+)
2	RS485T_1 (-)	1st RS485 Transmission Signal (-)
3	RS485T_2 (+)	2nd RS485 Transmission Signal (+)
6	RS485T_2 (-)	2nd RS485 Transmission Signal (-)
7	EGND	9V Ground Signal
8	EGND	9V Ground Signal

- DSW1: SINK / SOURCE Loop Switch**

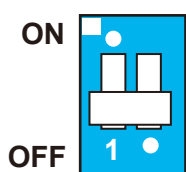

Label	Description
ON	SOURCE (connects to PNP device)
OFF	SINK (connects to NPN device)

- RSW1: Dial for Setting the Card ID Number**

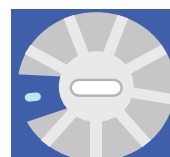

The number is set based on the value of the dial (between 0 ~ 15)

# EtherCAT Motion Control Card

- Advanced Type PCIe-L221-B1D0

## Specifications

Model Name	PCIe-L221-B1D0
Ring	1 Ring
Communication Interface	RJ-45
Communication Cable	CAT-5e
Communication Speed	100Mbps
Communication Distance	Max. 100m
Communication Hose and Slave Module	Max. 64
Motion Control Capability	Max. 32-axis synchronously
Digital Input	13-CH isolated, SINK/SOURCE type, 24V <sub>DC</sub> (5mA/CH)
Digital Output	13-CH isolated, SINK, 24V <sub>DC</sub> (100mA/CH)
Encoder Output	2-CH isolated, EA± / EB±
Compare Output	2-CH isolated, CMP±
Technical Indicators	PCI Spec. 2.2; supports 32-bit, 3.3/5V <sub>DC</sub> operation
Power Consumption	+5V <sub>DC</sub> at 1A typical
Operation Temperature	0°C ~ 50°C

## Exterior of the Motion Control Card

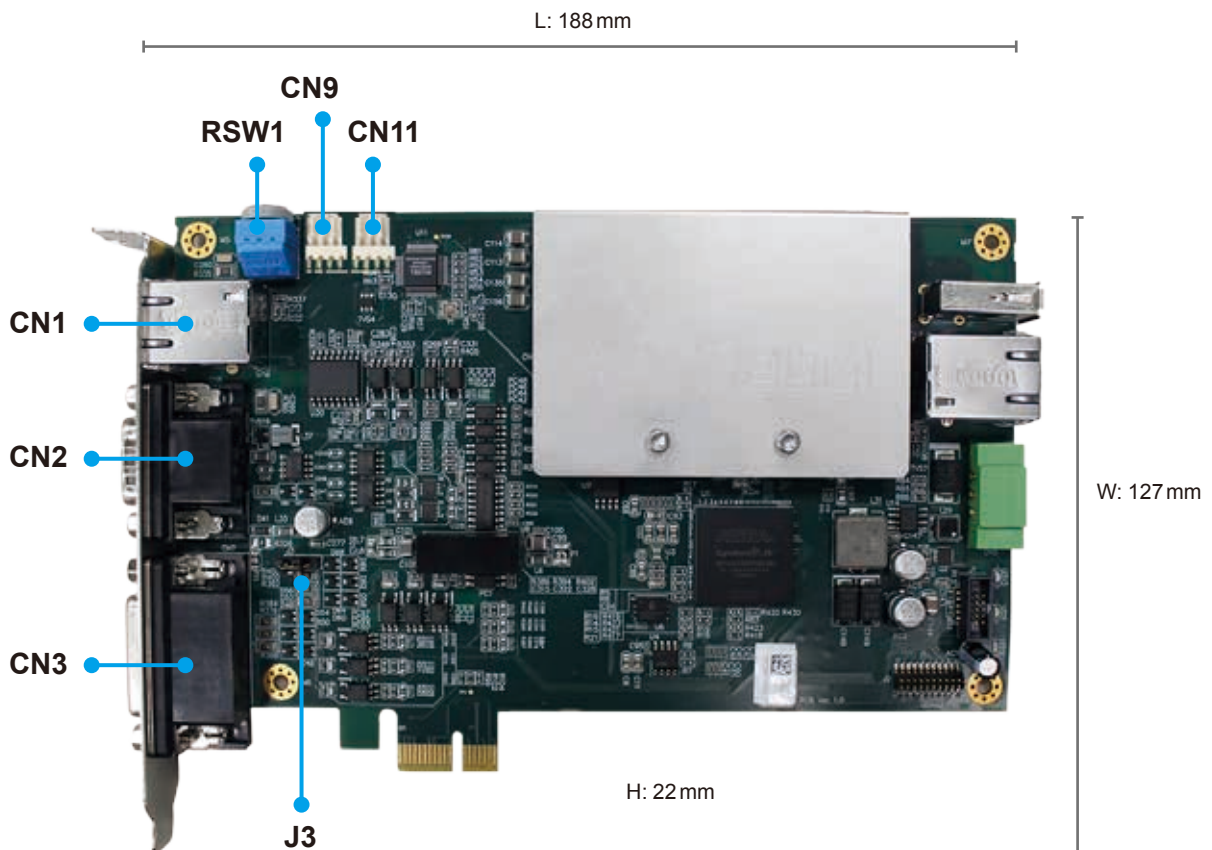

Title	Function	Title	Function
CN1	EtherCAT Expansion Module Connector	CN11	3.3V Compare Output (Channel 2 MOS)
CN2	Encoder & Compare Connector	RSW1	Card ID Number Setting Dial
CN3	Output / Input Signal Connector	J3	SINK / SOURCE Loop Switch
CN9	3.3V Compare Output (Channel 1 MOS)		

### ● CN1: EtherCAT Expansion Module Connector



PIN	標記	説明
1	TX+	Transmitted Data +
2	TX-	Transmitted Data -
3	RX+	Received Data +
6	RX-	Received Data -
LED (right)	GREEN	Link/Activity

### ● CN2: Encoder & Compare Connector



PIN	Label	Description	PIN	Label	Description
1	QA_1-	1st QA Signal (-)	9	QB_2+	2nd QB Signal (+)
2	QB_1-	1st QB Signal (-)	10	GPIO IN	GPIO Differential Signal
3	QA_2-	2nd QA Signal (-)	11	CMP_1+(RS-422)	1st RS422 Differential Signal (+)
4	QB_2-	2nd QB Signal (-)	12	CMP_1- (RS-422)	1st RS422 Differential Signal (-)
5	External GND	GND Signal	13	CMP_2+(RS-422)	2nd RS422 Differential Signal (+)
6	QA_1+	1st QA Signal (+)	14	CMP_2- (RS-422)	2nd RS422 Differential Signal (-)
7	QB_1+	1st QB Signal (+)	15	GPIO OUT	GPIO Output Signal
8	QA_2+	2nd QA Signal (+)			

### ● CN3: Digital Input / Output Connector

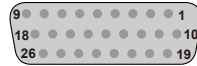

PIN	Label	Description	PIN	Label	Description
1	GPIO IN 0	GPIO Input Signal	14	GPIO OUT 4	GPIO Output Signal
2	GPIO IN 1	GPIO Input Signal	15	GPIO OUT 5	GPIO Output Signal
3	GPIO IN 2	GPIO Input Signal	16	GPIO OUT 6	GPIO Output Signal
4	GPIO IN 3	GPIO Input Signal	17	GPIO OUT 7	GPIO Output Signal
5	GPIO IN 4	GPIO Input Signal	18	External GND	GND Signal
6	GPIO IN 5	GPIO Input Signal	19	GPIO IN 8	GPIO Input Signal
7	GPIO IN 6	GPIO Input Signal	20	GPIO IN 9	GPIO Input Signal
8	GPIO IN 7	GPIO Input Signal	21	GPIO IN 10	GPIO Input Signal
9	External GND	GND Signal	22	GPIO IN 11	GPIO Input Signal
10	GPIO OUT 0	GPIO Output Signal	23	GPIO OUT 8	GPIO Output Signal
11	GPIO OUT 1	GPIO Output Signal	24	GPIO OUT 9	GPIO Output Signal
12	GPIO OUT 2	GPIO Output Signal	25	GPIO OUT 10	GPIO Output Signal
13	GPIO OUT 3	GPIO Output Signal	26	GPIO OUT 11	GPIO Output Signal

### ● CN9 : 3.3V Compare Output 1



PIN	Label	Description
1	CMP_OUT1(QEP1)	CMOS 3.3V Position Compare Signal Output
2	GND	GND Signal
3	CMP_+(LVDS)	LVDS Differential Signal (+)
4	CMP_1- (LVDS)	LVDS Differential Signal ( - )

### ● CN11 : 3.3V Compare Output 2

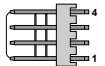

PIN	Label	Description
1	CMP_OUT2(QEP2)	CMOS 3.3V Position Compare Signal Output
2	GND	GND Signal
3	CMP_2+(LVDS)	LVDS Differential Signal (+)
4	CMP_2- (LVDS)	LVDS Differential Signal (-)

### ● J3 : SINK / SOURCE Loop Switch

Label	Description
1	I24V (Internal 24V Voltage Connector)
2	ICOM (Common Input Signal Connector)
3	24V Grounding Signal

### ● RSW1: Dial for Setting the Card ID Number



The number is set based on the value of the dial (between 0 ~ 15)

NPN mode: PIN1 & PIN2 short circuit (Default)  
PNP mode: PIN2 & PIN3 short circuit

# EtherCAT Motion Control Card

- Standard Type PCI-L221-P1D0

## Specifications

Model Name	PCI-L221-P1D0
Ring	1 Ring
Communication	RJ-45
Communication Cable	CAT-5e
Communication Speed	100Mbps
Communication Distance	Max. 100m
Communication Host and Slave Module	Max. 64
Motion Control Capability	Max. 32-Axes Synchronously
Digital Input	8-CH isolated, SINK/SOURCE type, 24V <sub>DC</sub> (5mA/CH)
Digital Output	4-CH isolated, SINK type, 24V <sub>DC</sub> (100mA/CH)
Technical Indicators	PCI Spec. 2.2; supports 32-bit, 3.3/5V <sub>DC</sub> operation
Power Consumption	+5V <sub>DC</sub> at 1A typical
Environment	0°C ~ 50°C

## Exterior of the Motion Control Card

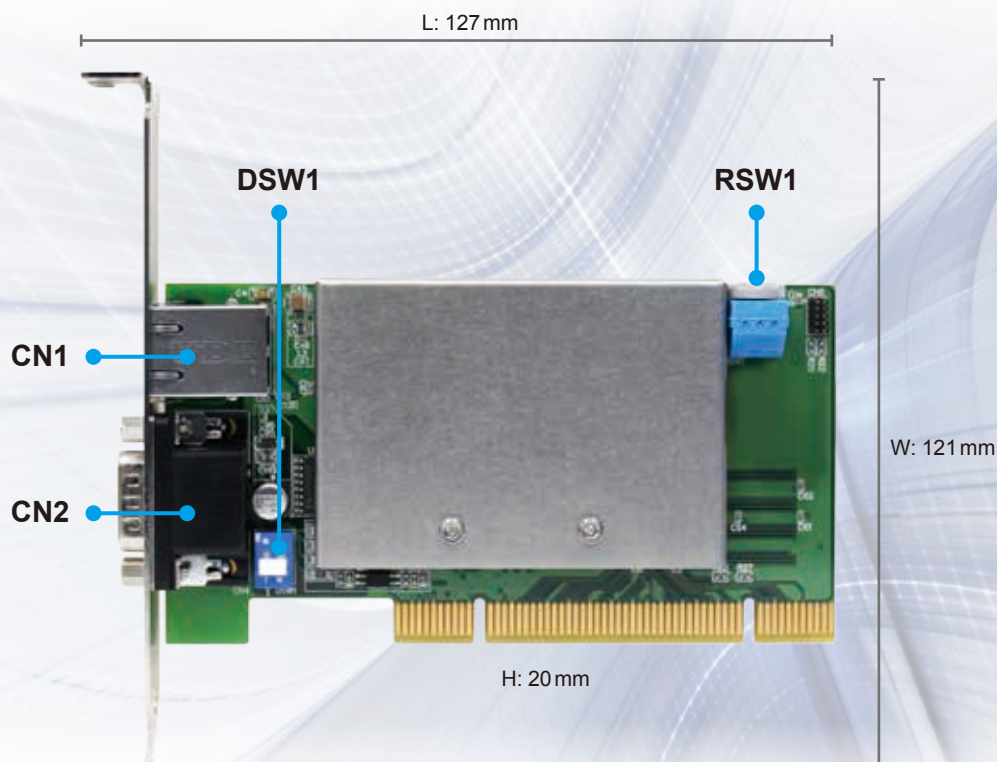

- **CN1: EtherCAT Connection Port**

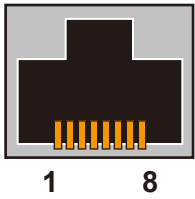

PIN	Label	Description
1	TX+	Transmission Signal (+)
2	TX-	Transmission Signal (-)
3	RX+	Transmission Signal (+)
6	RX-	Transmission Signal (-)

- **CN4: Digital Input / Output Connector**

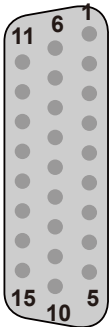

PIN	Label	Description	PIN	Label	Description
1	GPIO IN 0	GPIO Input Signal	9	GPIO IN 6	GPIO Input Signal
2	GPIO IN 1	GPIO Input Signal	10	GPIO IN 7	GPIO Input Signal
3	GPIO IN 2	GPIO Input Signal	11	External GND	GND Signal
4	GPIO IN 3	GPIO Input Signal	12	GPIO OUT 0	GPIO Output Signal
5	External GND	GND Signal	13	GPIO OUT 1	GPIO Output Signal
6	E24V	24 V <sub>DC</sub> Power	14	GPIO OUT 2	GPIO Output Signal
7	GPIO IN 4	GPIO Input Signal	15	GPIO OUT 3	GPIO Output Signal
8	GPIO IN 5	GPIO Input Signal	GPIO: General Purpose Input & Output		

- **DSW1: SINK / SOURCE Loop Switch**

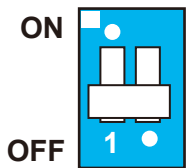

Label	Description
ON	SOURCE (Connects to PNP device)
OFF	SINK (Connects to NPN device)

- **RSW1: Dial for Setting the Card ID Number**

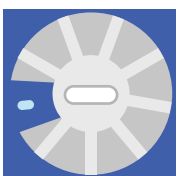

The number is set based on the value of the dial (between 0 ~ 15)

# EtherCAT Motion Control Card

- Advanced Type PCI-L221-B1D0

## Specifications

Model Name	PCI-L221-B1D0
Ring	1 Ring
Communication	RJ-45
Communication Cable	CAT-5e
Communication Speed	100Mbps
Communication Distance	Max. 100m
Communication Host and Slave Module	Max. 64
Motion Control Capability	Max. 32-Axes Synchronously
Digital Input	8-CH isolated, SINK/SOURCE type, 24V <sub>DC</sub> (5mA/CH)
Digital Output	4-CH isolated, SINK type, 24V <sub>DC</sub> (100mA/CH)
Encoder Input	2-CH isolated, EA± / EB±
Encoder Output	2-CH isolated, CMP±
Technical Indicators	PCI Spec. 2.2; supports 32-bit, 3.3/5V <sub>DC</sub> operation
Power Consumption	+5V <sub>DC</sub> at 1A typical
Environment	0°C ~ 50°C

## Exterior of the Motion Control Card

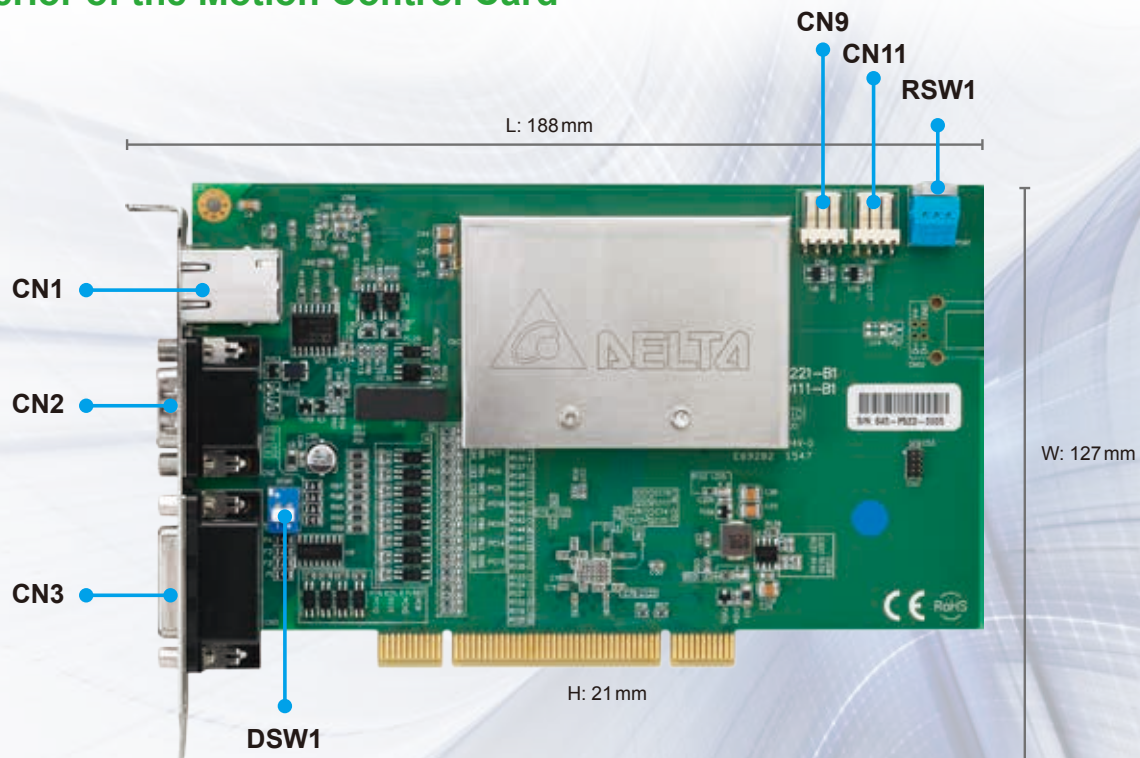



Title	Function	Title	Function
CN1	EtherCAT Expansion Module Connection Port	CN11	Position Compare Signal Output (Channel 2, 3.3V)
CN2	Encoder & Compare Connector	RSW1	Card ID Number Configuration Switch
CN3	Digital Input / Output Connector	DSW1	Input / Output Signal SINK / SOURCE Device Switch
CN9	Position Compare Signal Output (Channel 1, 3.3V)		

### ● CN1: Expansion Module Connection Port



PIN	Label	Description
1	TX+	Transmitted Data +
2	TX-	Transmitted Data -
3	RX+	Received Data +
6	RX-	Received Data -
LED (right)	GREEN	Link/Activity

### ● CNCN2: Encoder & Compare Connector

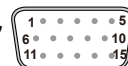

PIN	Label	Description	PIN	Label	Description
1	QA_1-	1st QA Signal (-)	9	QB_2+	2nd QB Signal (+)
2	QB_1-	1st QB Signal (-)	10	GPIO IN	GPIO Input Signal
3	QA_2-	2nd QA Signal (-)	11	CMP_1+(RS-422)	1st RS422 Differential Signal (+)
4	QB_2-	2nd QB Signal (-)	12	CMP_1- (RS-422)	1st RS422 Differential Signa (-)
5	External GND	GND Signal	13	CMP_2+(RS-422)	2nd RS422 Differential Signal (+)
6	QA_1+	1st QA Signal (+)	14	CMP_2- (RS-422)	2nd RS422 Differential Signal (-)
7	QB_1+	1st QB Signal (+)	15	GPIO OUT	GPIO Output Signal
8	QA_2+	2nd QA Signal (+)			

### ● CN3: Digital Input / Output Connector



PIN	Label	Description	PIN	Label	Description
1	GPIO IN 0	GPIO Input Signal	14	GPIO OUT 4	GPIO Output Signal
2	GPIO IN 1	GPIO Input Signal	15	GPIO OUT 5	GPIO Output Signal
3	GPIO IN 2	GPIO Input Signal	16	GPIO OUT 6	GPIO Output Signal
4	GPIO IN 3	GPIO Input Signal	17	GPIO OUT 7	GPIO Output Signal
5	GPIO IN 4	GPIO Input Signal	18	External GND	GND Signal
6	GPIO IN 5	GPIO Input Signal	19	GPIO IN 8	GPIO Input Signal
7	GPIO IN 6	GPIO Input Signal	20	GPIO IN 9	GPIO Input Signal
8	GPIO IN 7	GPIO Input Signal	21	GPIO IN 10	GPIO Input Signal
9	External GND	GND Signal	22	GPIO IN 11	GPIO Input Signal
10	GPIO OUT 0	GPIO Output Signal	23	GPIO OUT 8	GPIO Output Signal
11	GPIO OUT 1	GPIO Output Signal	24	GPIO OUT 9	GPIO Output Signal
12	GPIO OUT 2	GPIO Output Signal	25	GPIO OUT 10	GPIO Output Signal
13	GPIO OUT 3	GPIO Output Signal	26	GPIO OUT 11	GPIO Output Signal

### ● CN9: 3.3V Compare Output 1

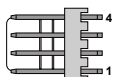

PIN	Label	Description
1	CMP_OUT1(QEP1)	Position Compare Signal Output (3.3V)
2	GND	GND Signal
3	CMP_+(LVDS)	LVDS Differential Signal (+)
4	CMP_1- (LVDS)	LVDS Differential Signal (-)

### ● CN11: 3.3V Compare Output 2

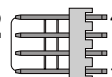

PIN	Label	Description
1	CMP_OUT2(QEP2)	Position Compare Signal Output (3.3V)
2	GND	GND Signal
3	CMP_2+(LVDS)	LVDS Differential Signal (+)
4	CMP_2- (LVDS)	LVDS Differential Signal (-)

### ● DSW1: SINK / SOURCE Loop Switch

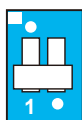

Label	Description
ON	SOURCE (Connects to PNP device)
OFF	SINK (Connects to NPN device)

### ● RSW1: Dial for Setting the Card ID Number



The number is set based on the value of the dial (between 0 ~ 15)

# 4-axis Pulse Motion Control Card

- **PCI-M324-F1D0**

## Specifications

Model Name	PCI-M324-F1D0
Pulse Output Type	OUT/DIR, CW/CCW, AB phase
Pulse Output Speed	Max. 3.2Mpps
Range	32-bit ( $\pm 2,147,483,648$ pulses)
Homing Mode	35 types
Velocity Profile	T-curve, S-curve
Interpolation	Linear, circular, helix and continuous
Response Signal Counter	32-bit up/down x 4
Latch Output	LTC x 4
Compare Output	CMP x 2
Incremental Encoder Input	$\pm EA$ x 4, $\pm EB$ x 4
Encoder Index Signal Input	$\pm EZ$ x 4
Signal Input Connector	PEL x 4, MEL x 4, ORG x 4, SLD x 4
Servo Drive Input Connector	ALM x 4, SVON x 4, ALMC x 4, INP x 4, RDY x 4, ERC x 4
General Input Terminals	IN x 4
General Output Terminals	OUT x 4
Emergency Stop Input Terminals	EMG x 1
I/O PIN type	Optically isolated with 2.5KVrms on all pins
PCI Slot	PCI Spec. 2.2; supports 32-bit, 3.3/5V <sub>DC</sub> operation
Power Consumption	+5V <sub>DC</sub> at 0.5A typical
Operation Temperature	0°C ~ 50°C

## Exterior of the Motion Control Card

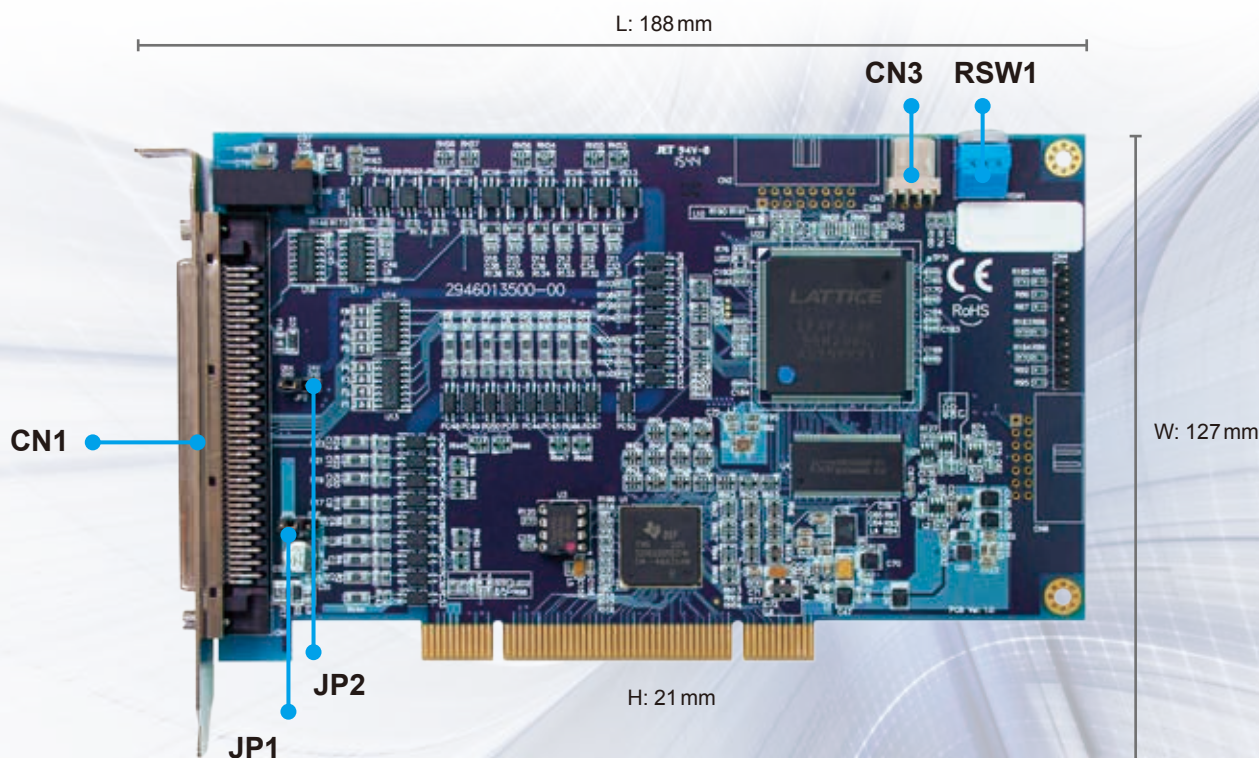

Title	Description
CN1	SCSI 100 pins, 4-axis Motion Control Input / Output Connector
CN3	Position Compare Signal Output
JP1	Jumper for Input Signal (NPN/PNP)
JP2	Jumper for Pulse Output I/O and External +24V Grounding Signal
RSW1	Card ID Number Configuration Switch

## ● CN1: Input / Output Connector

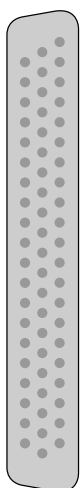

PIN	Description	PIN	Description	PIN	Description	PIN	Description
1	24V	26	ERC_2	51	24V	76	ERC_4
2	EGND	27	ALMC_2	52	EGND	77	ALMC_4
3	EMG	28	DO_2	53	EMG	78	DO_4
4	MEL_1	29	EA+_1	54	MEL_3	79	EA+_3
5	PEL_1	30	EA-_1	55	PEL_3	80	EA-_3
6	ORG_1	31	EB+_1	56	ORG_3	81	EB+_3
7	SLD_1	32	EB-_1	57	SLD_3	82	EB-_3
8	MEL_2	33	EZ+_1	58	MEL_4	83	EZ+_3
9	PEL_2	34	EZ-_1	59	PEL_4	84	EZ-_3
10	ORG_2	35	EA+_2	60	ORG_4	85	EA+_4
11	SLD_2	36	EA-_2	61	SLD_4	86	EA-_4
12	RDY_1	37	EB+_2	62	RDY_3	87	EB+_4
13	INP_1	38	EB-_2	63	INP_3	88	EB-_4
14	ALM_1	39	EZ+_2	64	ALM_3	89	EZ+_4
15	DI_1	40	EZ-_2	65	DI_3	90	EZ-_4
16	RDY_2	41	5V	66	RDY_4	91	5V
17	INP_2	42	DGND	67	INP_4	92	DGNO
18	ALM_2	43	DIR+_1	68	ALM_4	93	DIR+_3
19	DI_2	44	DIR-_1	69	DI_4	94	DIR-_3
20	EGND	45	OUT+_1	70	EGND	95	OUT+_3
21	SVON_1	46	OUT-_1	71	SVON_3	96	OUT-_3
22	ERC_1	47	DIR+_2	72	ERC_3	97	DIR+_4
23	ALMC_1	48	DIR-_2	73	ALM_3	98	DIR-_4
24	DO_1	49	OUT+_2	74	DO_3	99	OUT+_4
25	SVON_2	50	OUT-_2	75	SVON_4	100	OUT-_4

## ● CN3: Position Compare Signal Output

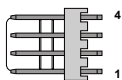

PIN	Label	Description
1	3.3V CMP_OUT	CMOS 3.3V Position Compare Signal Output
2	DGND	CMOS 3.3V Grounding Signal
3	DGND	CMOS 3.3V Grounding Signal
4	1.6(V) Vref	1.6V LVDS Voltage Reference

## ● RSW1: Dial for Setting the Card ID Number



The number is set based on the value of the dial (between 0 ~ 15)

## ● JP1: Jumper for Input Signal (NPN/PNP)



PIN	Label	Description
1	I24V	Internal +24V Voltage Connector
2	ICOM	Internal Input Signal Common Connector
3	EGND	24V Grounding Signal

## ● JP2: Jumper for Pulse Output I/O and External +24V Grounding Signal

PIN	Label	Description
1	Not use	Reserved (Not In Use)
2	IGND	DDA Pulse Grounding Signal
3	EGND	24V Grounding Signal

# Standard Data Capture Card

- Standard Type PCI-D122-XND0

## Specifications

Model Name		PCI-D122-XND0
Module Control	Function Mode	32 DI / 32 DO
	Additional Mode	MPG Function
	Input	32-CH Isolated
		Sink (NPN type) / Source (PNP type)
		24V@ 5mA
	Output	32-CH Isolated
Sink (NPN type)		
24V@ 200mA		
PCI Card Dimensions (With Bracket)	187.9 X 126.4 X 21.6 mm (W x H x D)	
PCI Specification	Ver2.2; supports 32-bit, 3.3V / 5V <sub>DC</sub> Operation	
General	Power Consumption	+5V <sub>DC</sub> at 0.5A typical
	Surge Voltage Tolerance	1500V <sub>AC</sub> (Primary-secondary); 1500V <sub>AC</sub> (Primary-PE)
	ESD	8KV Air Discharge
	EFT	Power Line-2KV
	RS	80MHz ~ 1GHz, 10V/M
	Operation Temperature	0°C ~ 50°C

## Exterior of the Motion Control Card

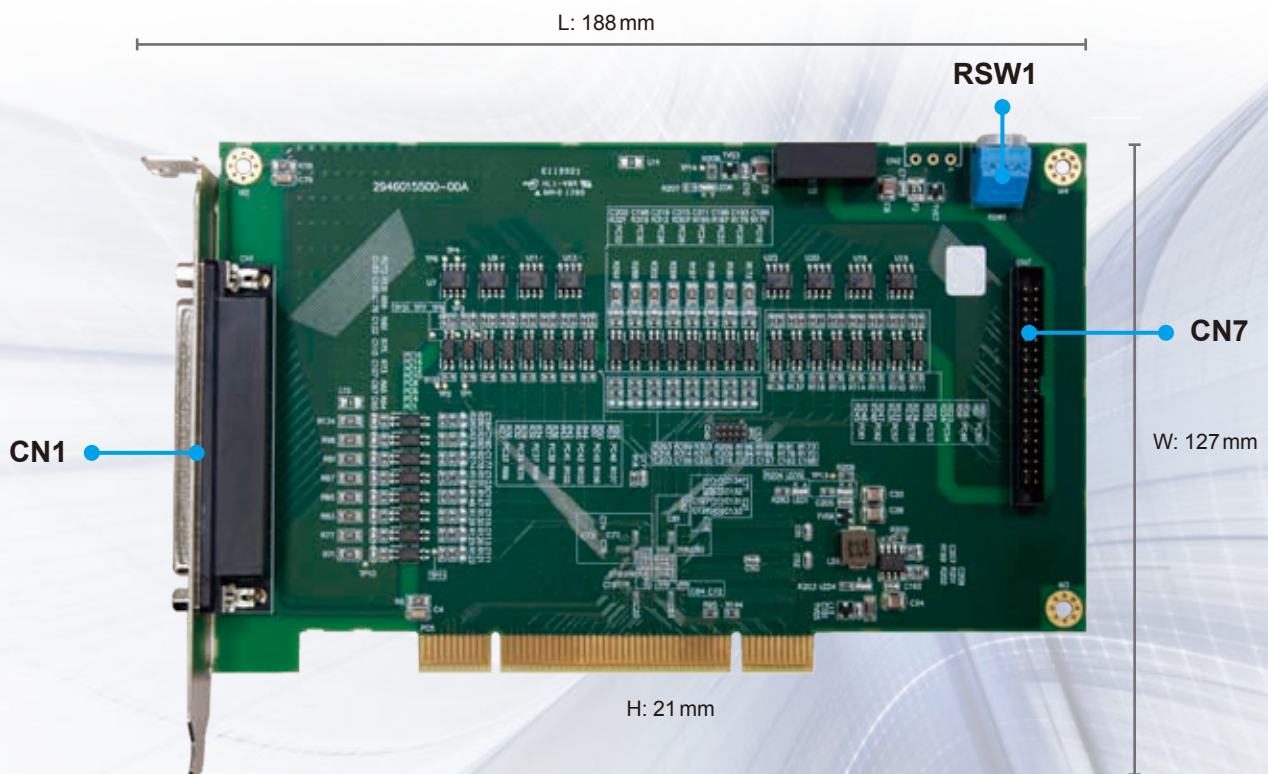

Title	Description
CN1	Input / Output Connector (CH0 ~ CH15)
CN7	Input / Output Connector (CH16 ~ CH31)
RSW1	Card ID Number Configuration Switch

## ● RSW1: Dial for Setting the Card ID Number



The number is set based on the value of the dial (between 0 ~ 15)

## ● CN1: Input / Output Connector

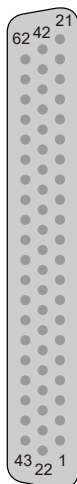

PIN	Label	Description	PIN	Label	Description
1	N.C	Reserved	20	GND	GND Signal
2	IN_00 *	GPIO Input Signal	21	OUT_00	GPIO Output Signal
3	IN_01 *	GPIO Input Signal	22	OUT_01	GPIO Output Signal
4	IN_02 *	GPIO Input Signal	23	OUT_02	GPIO Output Signal
5	IN_03 *	GPIO Input Signal	24	OUT_03	GPIO Output Signal
6	IN_04 *	GPIO Input Signal	25	OUT_04	GPIO Output Signal
7	IN_05 *	GPIO Input Signal	26	OUT_05	GPIO Output Signal
8	IN_06 *	GPIO Input Signal	27	OUT_06	GPIO Output Signal
9	IN_07 *	GPIO Input Signal	28	OUT_07	GPIO Output Signal
10	IN_08 *	GPIO Input Signal	29	OUT_08	GPIO Output Signal
11	IN_09 *	GPIO Input Signal	30	OUT_09	GPIO Output Signal
12	IN_10 *	GPIO Input Signal	31	OUT_10	GPIO Output Signal
13	IN_11 *	GPIO Input Signal	32	OUT_11	GPIO Output Signal
14	IN_12 *	GPIO Input Signal	33	OUT_12	GPIO Output Signal
15	IN_13 *	GPIO Input Signal	34	OUT_13	GPIO Output Signal
16	IN_14 *	GPIO Input Signal	35	OUT_14	GPIO Output Signal
17	IN_15 *	GPIO Input Signal	36	OUT_15	GPIO Output Signal
18	COM_0	Common Input 0	37	N.C	Reserved
19	GND	GND Signal			

## ● CN7: Input / Output Connector

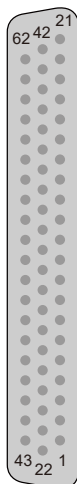

PIN	Label	Description	PIN	Label	Description
1	N.C	Reserved	2	GND	GND Signal
3	IN_00 *	GPIO Input Signal	4	OUT_00	GPIO Output Signal
5	IN_01 *	GPIO Input Signal	6	OUT_01	GPIO Output Signal
7	IN_02 *	GPIO Input Signal	8	OUT_02	GPIO Output Signal
9	IN_03 *	GPIO Input Signal	10	OUT_03	GPIO Output Signal
11	IN_04 *	GPIO Input Signal	12	OUT_04	GPIO Output Signal
13	IN_05 *	GPIO Input Signal	14	OUT_05	GPIO Output Signal
15	IN_06 *	GPIO Input Signal	16	OUT_06	GPIO Output Signal
17	IN_07 *	GPIO Input Signal	18	OUT_07	GPIO Output Signal
19	IN_08 *	GPIO Input Signal	20	OUT_08	GPIO Output Signal
21	IN_09 *	GPIO Input Signal	22	OUT_09	GPIO Output Signal
23	IN_10 *	GPIO Input Signal	24	OUT_10	GPIO Output Signal
25	IN_11 *	GPIO Input Signal	26	OUT_11	GPIO Output Signal
27	IN_12 *	GPIO Input Signal	28	OUT_12	GPIO Output Signal
29	IN_13 *	GPIO Input Signal	30	OUT_13	GPIO Output Signal
31	IN_14 *	GPIO Input Signal	32	OUT_14	GPIO Output Signal
33	IN_15 *	GPIO Input Signal	34	OUT_15	GPIO Output Signal
35	COM_1	Common Input 1	36	N.C	Reserved
37	COM_1	Common Input 1	38	N.C	Reserved
39	N.C	Reserved	40	GND	GND Signal

# DMCNET Remote Modules

## Digital Input Remote Modules

- ASD-DMC-RM32MN (32 Digital Inputs)
- ASD-DMC-RM64MN (64 Digital Inputs)
- ASD-DMC-RM32PT (16 Digital Inputs / 16 Digital Outputs)

## Electrical Specifications

Model Name	RM32MN / RM64MN / RM32PT
Input Circuit Type	Single common port input
Input Signal Type	SINK / SOURCE
Input Signal Voltage	24 V <sub>DC</sub> (5mA)
Response Time	0 to 3 ms, adjustable
Action Level (OFF > ON)	> 16.5V <sub>DC</sub>
Action Level (ON > OFF)	< 8V <sub>DC</sub>
Noise Tolerance Threshold	ESD (IEC 61131-2, IEC 61000-4-2): 8 KV Air Discharge EFT (IEC 61131-2, IEC 61000-4-4): Power Line: 2KV, Communication I/O: 1 KV RS (IEC 61131-2, IEC 61000-4-3): 80MHz ~ 1GHz, 10V/m
Environment	Operating Temperature: 0°C ~ 50°C Storage Temperature: -20°C ~ 70°C

## Installation & Wiring

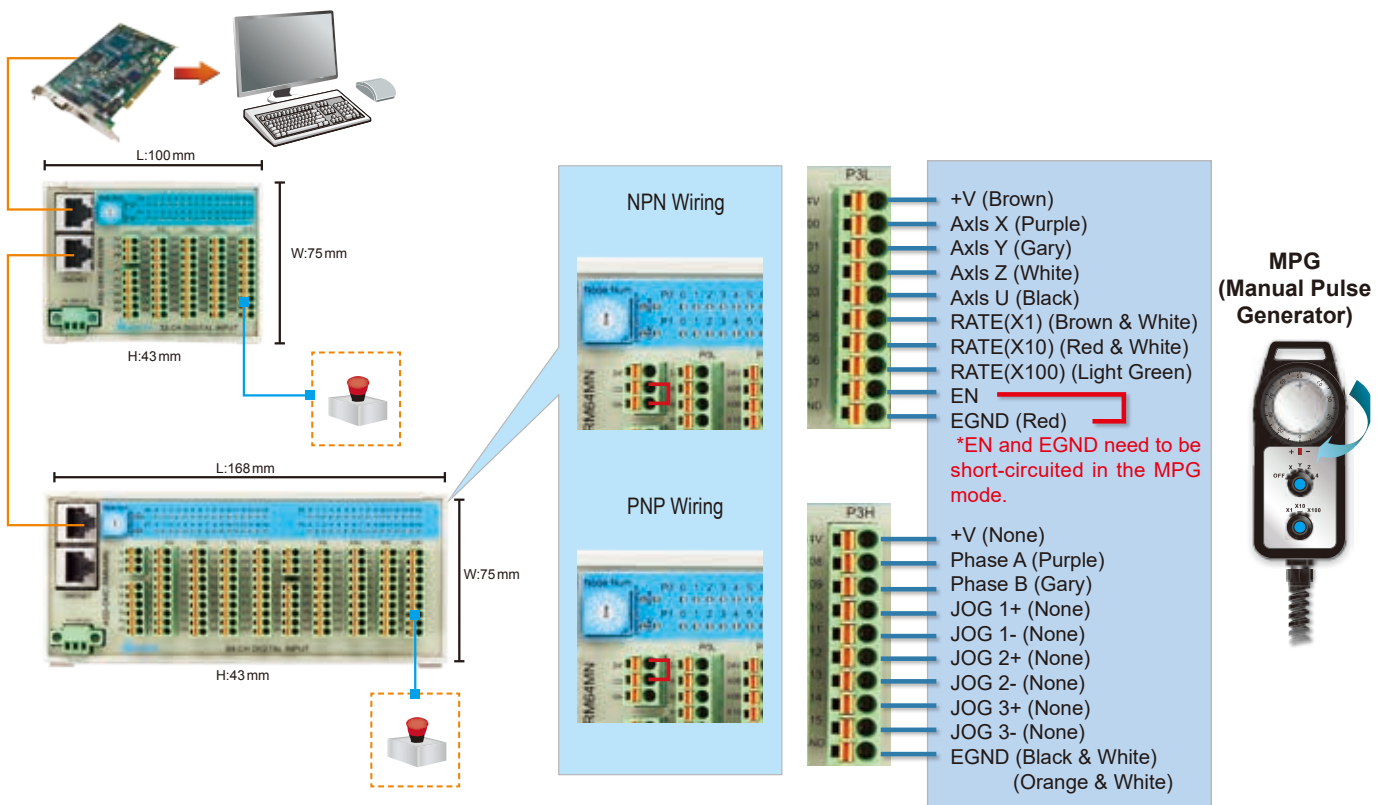

\*MPG can only be used for the terminals of P3H and P3L of ASD-DMC-RM64MN

## Digital Output Remote Modules

- **ASD-DMC-RM32NT (32 Digital Outputs)**
- **ASD-DMC-RM64NT (64 Digital Outputs)**
- **ASD-DMC-RM32PT (16 Digital Inputs / 16 Digital Outputs)**
  - Non-volatile memories can be managed through a software API
  - Load output: 0.1A / 1 Point

## Electrical Specifications

Model Name	RM32NT / RM64NT / RM32PT
Output Circuit Type	Transistor
Output Signal Type	SINK
Current Specifications	0.1A/1 point
Voltage Specifications	24 V <sub>DC</sub>
Maximum Switching (Operating) Frequency	1 KHz
Action Level (OFF > ON)	20 us
Action Level (ON > OFF)	30 us
Noise Tolerance Threshold	ESD (IEC 61131-2, IEC 61000-4-2): 8 KV Air Discharge EFT (IEC 61131-2, IEC 61000-4-4): Power Line: 2KV, Communication I/O: 1 KV RS (IEC 61131-2, IEC 61000-4-3): 80 MHz ~ 1 GHz, 10V/m
Environment	Operating Temperature: 0°C ~ 50°C Storage Temperature: -20°C ~ 70°C

## Installation & Wiring

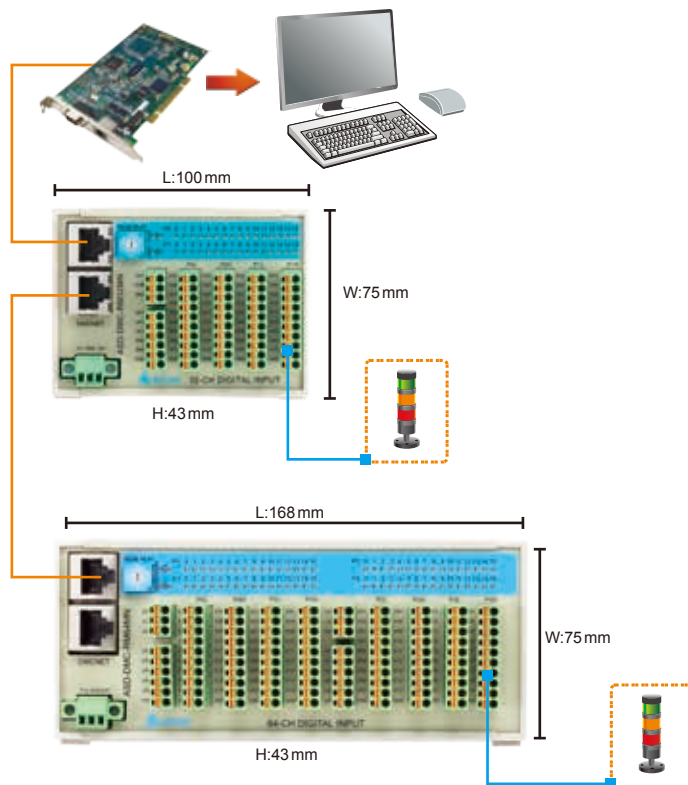

# DMCNET Remote Modules

## • ASD-DMC-RM04PI (4-Channel Pulse)

- 4 channels of 200 kHz pulse outputs (Pulse + Direction, CCW pulse + CW pulse, A phase + B phase)
- 4 channels of 200 kHz pulse inputs (CCW pulse + CW pulse, A phase + B phase)
- Digital Inputs x 8 / Digital Outputs x 8
- Built-in positive / negative limit and home for each channel
- In Mode 1, each RM04PI module occupies one node number only, and interpolation motion is carried out within one module.
  - 4 channels occupy 1 node number only
  - 4 channels occupy one PDO and SDO
  - Performs interpolation motion of 4 channels within one RM04PI module only
  - Transfers data in cyclical patterns
  - Motion commands set by parameters
  - Point-to-Point motion mode, motion position calculation is performed within one RM04PI module
- In Mode 2, each RM04PI module occupies node numbers 1~4, which correspond to 4 channels. The interpolation motion can be carried out among different modules.

## Electrical Specifications

ASD-DMC-RM04PI		ASD-DMC-RM04PI		
Item	Input (QA, QB, QZ, DI1, DI2)	Item	Input (MEL, PEL, ORG, SLD)	Output (CW, CCW, DO1, DO2)
Circuit Type	Single	Circuit Type	Single	Transistor
Signal Type	SINK	Signal Type	SINK / SOURCE	SINK
Power Supply Voltage	5V <sub>DC</sub>	Power Supply Voltage	24V <sub>DC</sub> (5mA)	5~24V <sub>DC</sub> (30mA / 1 point)
Work Frequency	QA, QB, QZ: 200 kHz (5mA / 1 point) DI1, DI2: 1 kHz (5mA / 1 point)	Response Time/ Work Frequency	1ms	CW, CCW : 200kHz DO1, DO2 : 1kHz
Noise Immunity	ESD (IEC 61131-2, IEC 61000-4-2): 8KV Air Discharge EFT (IEC 61131-2, IEC 61000-4-4): Power Line: 2KV Communication I/O: 1KV RS (IEC 61131-2, IEC 61000-4-3): 80MHz ~ 1GHz, 10V/m	Active Level (OFF > ON)	> 16.5V <sub>DC</sub>	-
		Active Level (ON > OFF)	< 8V <sub>DC</sub>	-
Operating/ Storage Environment	Operating: 0°C ~ 50°C (32°F ~ 122°F) Storage: -20°C ~ 70°C (-4°F ~ 158°F)	Noise Immunity	ESD (IEC 61131-2, IEC 61000-4-2): 8KV Air Discharge EFT (IEC 61131-2, IEC 61000-4-4): Power Line: 2KV Communication I/O: 1KV RS (IEC 61131-2, IEC 61000-4-3): 80MHz ~ 1GHz, 10V/m	
		Operating/Storage Environment	Operating: 0°C ~ 50°C (32°F ~ 122°F) Storage: -20°C ~ 70°C (-4°F ~ 158°F)	

## Installation & Wiring

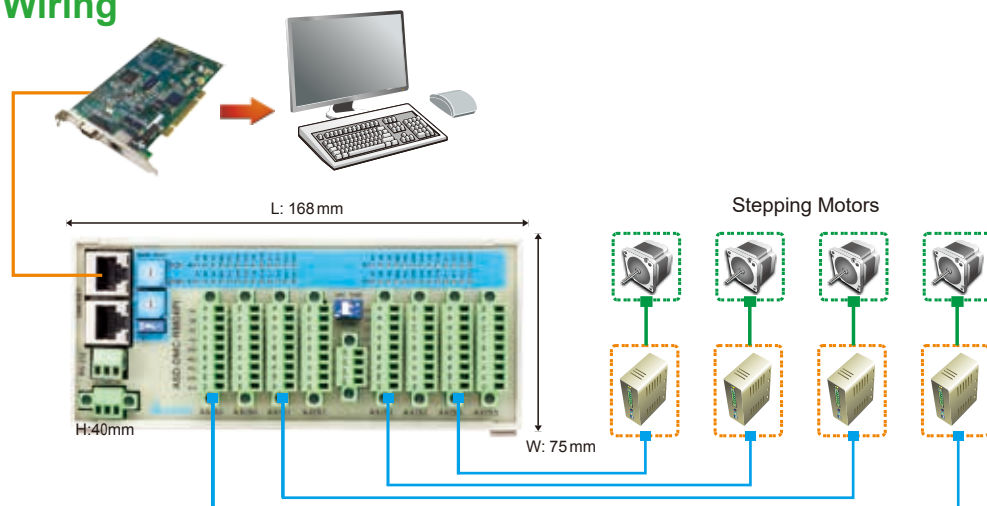



- **ASD-DMC-RM04AD (4-Channel Analog Input)**

### Electrical Specifications

ASD-DMC-RM04AD	
Channel	4 Channels / module
Voltage Analog Input Range	-10 ~ 10 V / -5 ~ 5 V / 0 ~ 10 V / 0 ~ 5 V
Current Analog Input Range	0 ~ 24 mA
Digital Conversion Range	0 ~ 65535
Resolution	16 bits
Voltage Input Resistance	140 kΩ
Current Input Resistance	249 Ω
General Precision	Within ±0.5% (25 °C, 77 °F) at full scale Within ±1% (0 ~ 55 °C, 32 ~ 131 °F) at full scale
Response Time	Min. 1 ms / Max. 3 ms × the number of channels
Isolation	Internal circuit and analog output terminals are isolated with an optical coupler
Voltage Absolute Input Range	-15 ~ 15
Current Absolute Input Range	32 mA
Digital Data Format	16 significant bits
Sampling Mode	Five modes which the average number is two (2), four (4), eight (8), sixteen (16) and thirty-two (32) are available for selection

### Installation & Wiring

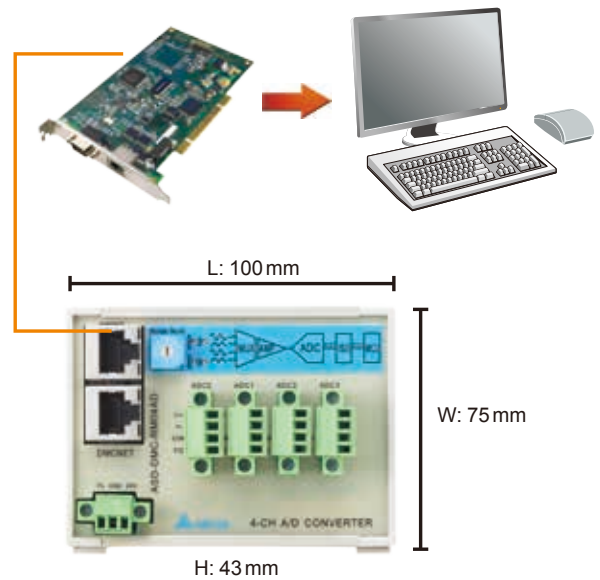

- **ASD-DMC-RM04DA (4-Channel Analog Output)**

### Electrical Specifications

ASD-DMC-RM04DA	
Channel	4 Channels / module
Voltage Output Range	-10 ~ 10 V / -5 ~ 5 V / 0 ~ 10 V / 0 ~ 5 V
Current Output Range	0 ~ 24 mA / 0 ~ 20 mA / 4 ~ 20 mA
Excess Limit (Voltage)	10 %
Maximum Output Current (Voltage)	20 mA
Allowable Load Resistance (Current)	0 ~ 500 Ω
Digital Data Range	0 ~ 4096
Resolution	16 bits
DC Output Resistance	0.3 Ω
Response Time	1 ms
Digital Data Format	16 bits
Isolation	Internal circuit and analog output terminals are isolated with an optical coupler
Protection	Voltage output is protected by short circuit, but must be aware of long-lasting short circuit damaging the internal circuits

### Installation & Wiring

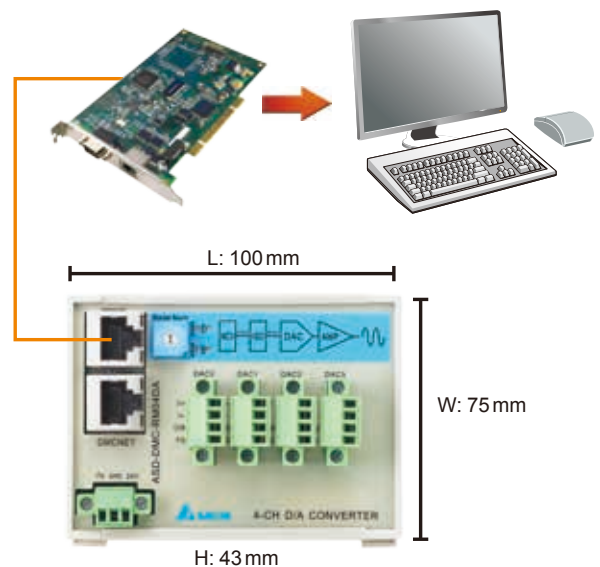

# DMCNET Remote Modules

- **HMC-RIO3232RT5 (Digital I/O Remote Module)**

- 16 points relay type output unit; max. loading: 2A / 1 Point with non-volatile memory function
- 16 points transistor type output unit; max. loading: 0.1A / 1 Point
- 32 points digital input unit – supports SINK and SOURCE modes

## Electrical Specifications

Model Name	HMC-RIO3232RT5
Supply Voltage	24 VDC (-10% ~ +15%) / 50 mA
Power Consumption	1.2W
Noise Immunity	RS: Frequency: 80MHz ~ 1GHz, 1.4GHz ~ 2.0GHz, Test level 10V/m ESD: Contact discharge ±8KV Air discharge ±8KV EFT: ±2KV(Power port), ±2KV (I/O line), Surge: ±2KV (RIO power port)
Temperature	Operating: 0°C ~ 55°C (Temperature), 10 ~ 90% (Humidity) Storage: -20°C ~ 60°C (Temperature), 10 ~ 90% (Humidity)
Vibration	IEC 61131-2 compliant 5Hz ~ 8.3Hz = Continuous: 3.5 mm, 8.3Hz ~ 150Hz = Continuous: 1.0 g
Shock	IEC 60068-2-27 compliant 15g peak for 11 ms duration X, Y, Z directions for 6 times
Weight	Approx. 460g

Item	Input Port	Item	Output Port
Input Signal Type	SINK / SOURCE	Output Circuit Type	Transistor / Relay
Input Signal Voltage	24 V <sub>DC</sub> ( 5 mA )	Voltage Specifications	24 V <sub>DC</sub> (-10% ~ +15%) / < 250 V <sub>AC</sub> (Relay Only)
Input Impedance	4.7K ohm	Current Specifications	100 mA / 1 Point (Transistor), 2A / 1 Point (Relay), Resistive Load
Action Level	(OFF → ON) > 16.5V <sub>DC</sub> (ON → OFF) < 5V <sub>DC</sub>	Maximum Switching (Operating) Frequency	8 k Hz (TR) / 1 Hz (RELAY)
		Response Time	TR: (ON → OFF): 115 μs, (OFF → ON): 12 μs RELAY: (ON → OFF): 10ms, (OFF → ON): 10ms

## Installation & Wiring

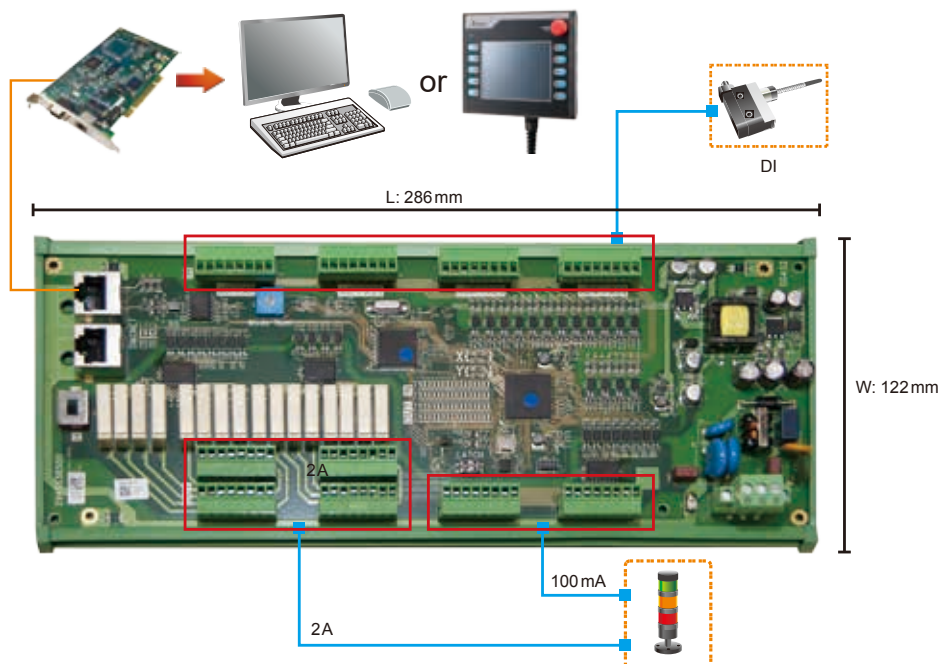

# Gateway Type Remote Power Coupler

## Master Module - GA Series • ASD-DMC-GA01



- One GA01 can connect up to a maximum of 4 GE remote modules, of which there may be a maximum of four GE01PH modules.
- 64-point input / 64-point output can be set in one station (extra station for over 64).
- The EzDMC provides a software auto calculation function for calculating the numbers of start and end stations of ASD-DMC-GA01.

### Switching Settings



ADDR1		
PIN	Function	Explanation
1 ~ 12	Start Node Address	Start Station

ADDR2		
PIN	Function	Explanation
1 ~ 12	End Node Address	End Station

ADDR1 & ADDR2  
 There is no communication when the value is set to 0 and 13 ~ 15.  
 When ADDR1 is set to 1 and ADDR2 is set to 2, it indicates that the remote modules have occupied two stations.

# Gateway Type Digital I/O Remote Module

## Slave Module - GE Series • Gateway Type 1-Channel Pulse Remote Module ASD-DMC-GE01PH





### Electrical Specifications

ASD-DMC-GE01PH		
Item	Input	Output
Circuit Type	Single common port input	Transistor
Signal Type	SINK / SOURCE	SINK
Signal Voltage	24 V <sub>DC</sub> (5 mA)	5 ~ 24 V <sub>DC</sub> (30 mA/1 point)
Response Time	1 ms	
Maximum Input Pulse Frequency	QA+, QB+, QZ+, QA-, QB-, QZ-: 4 MHz (5 mA / 1 point)	CW, CCW: 4 MHz (30 mA / 1 point) SVON, RALM: 1 kHz (30 mA / 1 point)
Action Level (OFF → ON)	> 16.5 V <sub>DC</sub>	-
Trigger Level (ON → OFF)	< 8 V <sub>DC</sub>	-
Output Circuit Type	-	RS-422
Output Signal Type	-	Differential

# ASDA-A3-F Servo Drive Specifications



ASDA-A3-F Series		100 W	200 W	400 W	750 W	1 kW	1.5 kW	2 kW	3 kW
		01	02	04	07	10	15	20	30
Power Supply	Phase / Voltage	single-phase / 3-phase 220 VAC						3-phase 220 VAC	
	Permissible Voltage Range	1-phase / 3-phase 200 ~ 230 VAC, -15% ~ 10%						3-phase 200 ~ 230 VAC, -15% ~ 10%	
	Input Current (3PH) (Units: Arms)	0.67	1.34	2.67	5.01	6.68	10.02	13.36	20.05
	Input Current (1PH) (Units: Arms)	1.16	2.31	4.63	8.68	11.57	17.36	-	-
	Continuous Output Current (Units: Arms)	0.9	1.55	2.6	5.1	7.3	8.3	13.4	19.4
	Instantaneous Maximum Output Current (Units: Arms)	3.54	7.07	10.61	21.21	24.75	35.36	53.03	70.71
Cooling System		Natural Air Circulation			Fan Cooling				
Encoder Resolution / Feedback Resolution		24-bit (16777216 p/rev)							
Control of Main Circuit		SVPWM Control							
Tuning Modes		Manual / Auto							
Regenerative Resistor		None			Built-in				
Position Control Mode	Max. Input Pulse Frequency (Only for Non-DMCNET mode)	Pulse + Direction, A phase + B phase, CCW pulse + CW pulse							
	Pulse Type (Only for Non-DMCNET mode)	Pulse + Icon: 4 Mpps; CCW Pulse + CW Pulse: 4 Mpps, A-phase + B-phase: single-phase 4Mpps, Open collector: 200 Kpps							
	Command Source	External pulse train (PT mode) (Only for Non-DMCNET mode) / Internal parameters (PR mode)							
	Smoothing Strategy	Low-pass and P-curve filter							
	Electronic Gear	Electronic gear ratio: N / M multiple N: 1 ~ 536870911 / M: 1~ 2147483647 (1/4 <N/M < 262144)							
	Torque Limit Operation	Set by parameters							
	Feed Forward Compensation	Set by parameters							

ASDA-A3-F Series			100 W	200 W	400 W	750 W	1 kW	1.5 kW	2 kW	3 kW	
			01	02	04	07	10	15	20	30	
Speed Control Mode	Analog Input Command (Only for Non-DMCNET mode)	Voltage Range	0 ~ ±10 V <sub>DC</sub>								
		Resolution	15-bit								
		Input Resistance	1MΩ								
		Time Constant	25 μs								
	Speed Control Range <sup>*1</sup>	1 : 6000									
	Command Source	External analog signal (Only for Non-DMCNET mode) / Internal parameters									
	Smoothing Strategy	Low-pass and S-curve filter									
	Torque Limit Operation	Set by parameters or via analog input (Only for Non-DMCNET mode)									
	Frequency Response Characteristic	Max. 3.1kHz									
	Speed Accuracy <sup>*2</sup>	0.01% or less at 0 ~ 100% load fluctuation									
0.01% or less at ±10% power fluctuation											
0.01% or less at 0°C to 50°C ambient temperature fluctuation											
Torque Control Mode	Analog Input Command (Only for Non-DMCNET mode)	Voltage Range	0 ~ ±10 V <sub>DC</sub>								
		Input Resistance	1MΩ								
		Time Constant	25 μs								
	Command Source	External analog signal (Only for Non-DMCNET mode) / Internal parameters									
	Speed Limit Operation	Set by parameters or via analog input (Only for Non-DMCNET mode)									
Analog Monitor Output			Monitor signal can set by parameters (Output voltage range: ±8 V); Resolution: 10-bit								
Digital Inputs / Outputs	Inputs	Servo on, Reset, Gain switching, Pulse clear, Zero speed CLAMP, Command input reverse control, Command triggered, Speed/Torque limit enabled, Position command selection, Motor stop, Speed position selection, Position / Speed mode switching, Speed / Torque mode switching, Torque / Position mode switching, PT / PR command switching, Emergency stop, Forward / Reverse inhibit limit, Reference "Home" sensor, Forward / Reverse operation torque limit, Move to "Home", Electronic Cam (E-Cam), Forward / Reverse JOG input, Event trigger PR command, Electronic gear ratio (Numerator) selection and Pulse inhibit inputs									
	Outputs	Encoder signal output (A, B, Z Line Driver) Servo ready, Servo on, At Zero speed, At Speed reached, At Positioning completed, At Torques limit, Servo alarm (Servo fault) activated, Electromagnetic brake control, Homing completed, Output overload warning, Servo warning activated, Position command overflow, Forward / Reverse software limit, Internal position command completed, Capture operation completed output., Motion control completed output., Master position of E-Cam (Electronic Cam)									
Protective Functions		Overcurrent, Overvoltage, Undervoltage, Motor overheated, Regeneration error, Overload, Overspeed, Abnormal pulse control command, Excessive deviation, Encoder error, Adjustment error, Emergency stop activated, Reverse/ Forward limit switch error, Position excessive deviation of full-close control loop, Serial communication error, Input power phase loss, Serial communication time out, short circuit protection of U, V, W, and CN1, CN2, CN3 terminals									
Communication Interface		RS-485 / CANopen / USB									
Environment	Installation Site	Indoor location (avoid direct sunlight), No corrosive liquid and gas (avoid oil mist, flammable gas, dust)									
	Altitude	Altitude 1000m or lower above sea level									
	Atmospheric Pressure	86kPa ~ 106kPa									
	Operating Temperature	0 °C ~ 55 °C (If operating temperature is above 45°C, forced cooling will be required)									
	Storage Temperature	-20 °C ~ 65 °C									
	Humidity	0 ~ 90% RH (non-condensing)									
	Vibration	9.80665m/s <sup>2</sup> (1G) less than 20 Hz, 5.88 m/s <sup>2</sup> (0.6G) 20 ~ 50 Hz									
	IP Rating	IP20									
	Power System	TN System <sup>**4</sup>									
Certifications	IEC/EN 61800-5-1 · UL 508C  										

\*1. Rated rotation speed: when full load, speed ratio is defined as the minimum speed (the motor will not pause)

\*2. When command is rated rotation speed, the speed fluctuation rate is defined as: (Empty load rotation speed Full load rotation speed) / Rated rotation speed



\*3. TN system: A power distribution system having one point directly earthed, the exposed conductive parts of the installation being connected to that point by protective earth conductor

\*4. Single-phase model uses single-phase three wire connection

# ASDA-A2-F DMCNET Servo Drive Specifications



ASDA-A2-F Series		100W	200W	400W	750W	1kW	1.5kW	2kW	3kW	4.5kW	5.5kW	7.5kW	
		01	02	04	07	10	15	20	30	45	55	75	
Power Supply	Phase / Voltage	Three-phase / Single-phase 220V <sub>AC</sub>						3-phase 220V <sub>AC</sub>					
	Permissible Voltage Range	1-phase / 3-phase 200 ~ 230V <sub>AC</sub> , -15% ~ 10%						3-phase 200 ~ 230V <sub>AC</sub> , -15% ~ 10%					
	Input Current (3PH) (Units: Arms)	0.39	1.11	1.86	3.66	4.68	5.9	8.76	9.83	17.5	19.4	26.3	
	Input Current (1PH) (Units: Arms)	0.69	1.92	3.22	6.78	8.88	10.3	-	-	-	-	-	
	Continuous Output Current (Units: Arms)	0.9	1.55	2.6	5.1	7.3	8.3	13.4	19.4	32.5	40	47.5	
Cooling System		Natural Air Circulation					Fan Cooling						
Encoder Resolution / Feedback Resolution		Incremental encoder: 20-bit (1280000 p/rev); Absolute encoder: 17-bit											
Control of Main Circuit		SVPWM (Space Vector Pulse Width Modulation) Control											
Tuning Modes		Auto / Manual											
Regenerative Resistor		None			Built-in						External		
Position Control Mode	Max. Input Pulse Frequency (Only for Non-DMCNET mode)	Max. 500Kpps / 4Mpps (Line driver), Max. 200Kpps (Open collector)											
	Pulse Type (Only for Non-DMCNET mode)	Pulse + Direction, A phase + B phase, CCW pulse + CW pulse											
	Command Source	External pulse train (PT mode) (Only for Non-DMCNET mode) / Internal parameters (PR mode)											
	Smoothing Strategy	Low-pass and P-curve filter											
	Electronic Gear	Electronic gear N/M multiple N: 1 ~ 32767, M: 1 : 32767 (1/50 < N/M < 25600)											
	Torque Limit Operation	Set by parameters											
	Feed Forward Compensation	Set by parameters											

ASDA-A2-F Series			100 W	200 W	400 W	750 W	1 kW	1.5 kW	2 kW	3 kW	4.5 kW	5.5 kW	7.5 kW
			01	02	04	07	10	15	20	30	45	55	75
Speed Control Mode	Analog Input Command (Only for Non-DMCNET mode)	Voltage Range	0 ~ ±10V <sub>DC</sub>										
		Input Resistance	10KΩ										
		Time Constant	2.2μs										
	Speed Control Range <sup>*1</sup>	1 : 5000										1 : 3000	
	Command Source	External analog signal (Only for Non-DMCNET mode) / Internal parameters											
	Smoothing Strategy	Low-pass and S-curve filter											
	Torque Limit Operation	Set by parameters or via analog input (Only for Non-DMCNET mode)											
	Frequency Response Characteristic	Max. 1 kHz											
	Speed Accuracy <sup>*2</sup> (At rated rotation speed)	0.01% or less at 0 ~ 100% load fluctuation											
0.01% or less at ±10% power fluctuation													
0.01% or less at 0°C to 50°C ambient temperature fluctuation													
Torque Control Mode	Analog Input Command (Only for Non-DMCNET mode)	Voltage Range	0 ~ ±10V <sub>DC</sub>										
		Input Resistance	10KΩ										
		Time Constant	2.2μs										
	Command Source	External analog signal (Only for Non-DMCNET mode) / Internal parameters											
	Smoothing Strategy	Low-pass filter											
Speed Limit Operation	Set by parameters or via analog input (Only for Non-DMCNET mode)												
Analog Monitor Output	Monitor signal can set by parameters (Output voltage range: ±8V)												
Digital Inputs / Outputs	Inputs	Servo on, Reset, Gain switching, Pulse clear, Zero speed CLAMP, Command input reverse control, Command triggered, Speed/Torque limit enabled, Position command selection, Motor stop, Speed position selection, Position / Speed mode switching, Speed / Torque mode switching, Torque / Position mode switching, PT / PR command switching, Emergency stop, Forward / Reverse inhibit limit, Reference "Home" sensor, Forward / Reverse operation torque limit, Move to "Home", Electronic Cam (E-Cam), Forward / Reverse JOG input, Event trigger PR command, Electronic gear ratio (Numerator) selection and Pulse inhibit inputs <sup>*3</sup>											
	Outputs	Encoder signal output (A, B, Z Line Driver and Z Open Collector ) Servo ready, Servo on, At Zero speed, At Speed reached, At Positioning completed, At Torques limit, Servo alarm (Servo fault) activated, Electromagnetic brake control, Homing completed, Output overload warning, Servo warning activated, Position command overflow, Forward / Reverse software limit, Internal position command completed, Capture operation completed output., Motion control completed output., Master position of E-Cam (Electronic Cam)											
Protective Functions	Overcurrent, Overvoltage, Undervoltage, Motor overheated, Regeneration error, Overload, Overspeed, Abnormal pulse control command, Excessive deviation, Encoder error, Adjustment error, Emergency stop activated, Reverse/ Forward limit switch error, Position excessive deviation of full-close control loop, Serial communication error, Input power phase loss, Serial communication time out, short circuit protection of U, V, W, and CN1, CN2, CN3 terminals												
Communication Interface	RS-232 / RS-485 / CANopen / USB / DMCNET												
Environment	Installation Site	Indoor location (avoid direct sunlight), No corrosive liquid and gas (avoid oil mist, flammable gas, dust)											
	Altitude	Altitude 1000m or lower above sea level											
	Atmospheric Pressure	86 kPa ~ 106 kPa											
	Operating Temperature	0°C ~ 55°C (If operating temperature is above 45°C, forced cooling will be required)											
	Storage Temperature	-20°C ~ 65°C (-4°F ~ 149°F)											
	Humidity	0 ~ 90% RH (non-condensing)											
	Vibration	9.80665m/s <sup>2</sup> (1G) less than 20 Hz, 5.88 m/s <sup>2</sup> (0.6G) 20 ~ 50 Hz											
	IP Rating	IP20											
Power System	TN System <sup>*4</sup>												
Certifications	IEC/EN 61800-5-1, UL 508C, C-tick   US LISTED 												

\*1. Rated rotation speed: when full load, speed ratio is defined as the minimum speed (the motor will not pause)

\*2. When command is rated rotation speed, the speed fluctuation rate is defined as: (Empty load rotation speed Full load rotation speed) / Rated rotation speed

\*3. Please note that the above digital signals and inputs are available only for Non-DMCNET mode. In DMCNET mode, it is recommended to write digital inputs into the servo drives through DMCNET communication, and the digital inputs should be used for Emergency Stop, Forward / Reverse Inhibit limit and Reference "Home" sensor only





\*4. TN system: A power distribution system having one point directly earthed, the exposed conductive parts of the installation being connected to that point by protective earth conductor

# ASDA-B2-F DMCNET Servo Drive Specifications



ASDA-B2-F Series		100 W	200 W	400 W	750 W	1 kW	1.5 kW	2 kW	3 kW
		01	02	04	07	10	15	20	30
Power Supply	Phase / Voltage	Three-phase 170 ~ 255 V <sub>AC</sub> , 50/60 Hz ±5%						Three - phase 170 ~ 255 V <sub>AC</sub> , 50/60 Hz ±5%	
		Single-phase 200 ~ 255 V <sub>AC</sub> , 50/60 Hz ±5%							
	Input Current (3PH) (Units: Arms)	0.7	1.11	1.86	3.66	4.68	5.9	8.76	9.83
	Input Current (1PH) (Units: Arms)	0.9	1.92	3.22	6.78	8.88	10.3	-	-
	Continuous Output Current (Units: Arms)	0.9	1.55	2.6	5.1	7.3	8.3	13.4	19.4
Cooling System		Natural Air Circulation				Fan Cooling			
Encoder Resolution		17-bit (160,000 p/rev)							
Main Circuit Control		Space Vector Pulse Width Modulation (SVPWM) Control							
Control Mode		Auto / Manual							
Regenerative Resistor		None		Built-in					
Position Control Mode	Max. Input Pulse Frequency	Transmitted by differential: 500 K (low speed) / 4 Mpps (high-speed) Transmitted by open-collector: 200 Kpps							
	Pulse Type	Pulse + Direction, A phase + B phase, CCW pulse + CW pulse							
	Command Source	External pulse							
	Smoothing Strategy	Low-pass filter							
	E-gear Ratio	Electronic gear N/M multiple N: 1 ~ (2 <sup>26</sup> -1) / M: 1 ~ (2 <sup>31</sup> -1) (1/50 < N/M < 25600)							
	Torque Limit Operation	Set by parameters							
	Feed Forward Compensation	Set by parameters							



ASDA-B2-F Series			100 W	200 W	400 W	750 W	1 kW	1.5 kW	2 kW	3 kW	
			01	02	04	07	10	15	20	30	
Speed Control Mode	Analog Input Command	Voltage Range	0 ~ ±10V <sub>DC</sub>								
		Input Resistance	10KΩ								
		Time Constant	2.2 μs								
	Speed Control Range <sup>*1</sup>		1 : 5000								
	Command Source		External analog signal / Internal parameters								
	Smoothing Strategy		Low-pass and S-curve filter								
	Torque Limit		Set by parameters or via analog input								
	Bandwidth		Max. 550Hz								
	Speed Accuracy <sup>*2</sup>		±0.01% at 0 ~ 100% load fluctuation								
±0.01% at ±10% power fluctuation											
±0.01% at 0 °C ~ 55 °C ambient temperature fluctuation											
Torque Control Mode	Analog Input Command	Voltage Range	0 ~ ±10V <sub>DC</sub>								
		Input Resistance	10KΩ								
		Time Constant	2.2 μs								
	Command Source		External analog signal / Internal parameters								
	Smoothing Strategy		Low-pass filter								
Speed Limit		Set by parameters or via analog input									
Analog Monitor Output		Monitor signal can set by parameters (Output voltage range: ±8V)									
Digital Input / Output	Input	Servo on, Fault reset, Gain switch, Pulse clear, Zero clamp, Command input reverse control, Torque limit, Speed limit, Speed command selection, Speed/position mode switching, Speed/torque mode switching, Torque/position mode switching, Emergency stop, Positive/negative limit, Forward/reverse operation torque limit, Forward/reverse JOG input, E-gear N selection, Pulse input prohibition									
	Output	Encoder signal output (A, B, Z Line Driver / Z Open collector) Servo on, Servo ready, Zero speed, Target speed reached, Target position reached, Torque limiting, Servo alarm, Brake control, Early warning for overload, Servo warning									
Protective Functions		Over current, Overvoltage, Under voltage, Overheat, Excessive speed deviation, Excessive position deviation, Encoder error, Emergency stop, Communication error, Short-circuit protection of terminal U, V, W and CN1, CN2, CN3									
Communication Interface		RS-232 / RS-485									
Environment	Installation Site		Indoor location (avoid direct sunlight), no corrosive liquid and gas (avoid oil mist, flammable gas, dust)								
	Altitude		Altitude 1000m or lower above sea level								
	Atmospheric Pressure		86 kPa ~ 106 kPa								
	Operating Temperature		0 °C ~ 55 °C (If operating temperature is above 45 °C, forced cooling will be required)								
	Storage Temperature		-20 °C ~ 65 °C (-4 °F ~ 149 °F)								
	Humidity		0 ~ 90% (non-condensing)								
	Vibration		Under 20Hz, 9.80665 m/s <sup>2</sup> (1G), 20 ~ 50 Hz 5.88 m/s <sup>2</sup> (0.6 G)								
	IP Rating		IP20								
	Power System		TN System <sup>*3</sup>								
Certifications		IEC/EN 61800-5-1    									

\*1. When it is in rated load, the speed ratio is: the minimum speed (smooth operation) / rated speed



\*2. When the command is the rated speed, the velocity correction ratio is: (rotational speed with no load - rotational speed with full load) / rated speed

\*3. TN system: The neutral point of the power system connects to the ground directly. The exposed metal components connect to the ground via the protective earth conductor

# ASDA-M DMCNET Servo Drive Specifications



ASDA-M Series		750W	1.5kW
		07	15
Power Supply	Phase / Voltage	Three-Phase or Single-Phase 220 V <sub>AC</sub>	
	Permissible Voltage Range	Three-Phase or Single-Phase 200~230 V <sub>AC</sub> , -15% ~ 10%	
	Input Current (3PH) (Units: Arms)	9.3	18.6
	Input Current (1PH) (Units: Arms)	17.8	33.3
	Continuous Output Current	5.1	8.3
Cooling System		Fan Cooling	
Encoder Resolution / Feedback Resolution		20-bit (1280000 p/rev)	
Control of Main Circuit		Space Vector Pulse Width Modulation (SVPWM) Control	
Tuning Modes		Auto / Manual	
Regenerative Resistor		None	
Position Control Mode	Max. Input Pulse Frequency	Max. 500Kpps / 4Mpps (Line driver) Max. 200Kpps (Open collector)	
	Pulse Type	Pulse + Direction, A phase + B phase, CCW pulse + CW pulse	
	Command Source	External pulse train (Pt mode) / Internal procedures (Pr mode)	
	Smoothing Strategy	Low-pass and P-curve filter	
	Electronic Gear	Electronic gear N/M multiple N: 1 ~ 32767, M: 1 : 32767 (1/50 < N/M < 25600)	
	Torque Limit Operation	Set by parameters	
	Feed Forward Compensation	Set by parameters	
Speed Control Mode	Analog Input Command	Voltage Range	0 ~ ±10 V <sub>DC</sub>
		Input Resistance	10KΩ
		Time Constant	2.2 μs
	Speed Control Range <sup>1</sup>	1 : 5000	
	Command Source	External analog signal / Internal parameters	
	Smoothing Strategy	Low-pass and S-curve filter	
	Torque Limit Operation	Set by parameters or via analog input	
	Frequency Response Characteristic	Max. 1kHz	
Speed Accuracy <sup>2</sup> (at rated rotation speed)	0.01% or less at 0 ~ 100% load fluctuation		
	0.01% or less at ±10% power fluctuation		
	0.01% or less at 0°C ~ 50°C ambient temperature fluctuation		

ASDA-M Series			750 W	1.5 kW
			07	15
Torque Control Mode	Analog Input Command	Voltage Range	0 ~ ±10V <sub>dc</sub>	
		Input Resistance	10KΩ	
		Time Constant	2.2μs	
	Command Source		External analog signal / Internal parameters	
	Smoothing Strategy		Low-pass filter	
Speed Limit Operation		Set by parameters or via analog input		
Analog Monitor Output		Monitor signal can be set by parameters (Output voltage range: ±8V)		
Digital Inputs/Outputs	Inputs		Servo On, Reset, Gain switching, Pulse clear, Zero speed CLAMP, Command input reverse control, Command triggered, Speed / Torque limit enabled, Position command selection, Motor stop, Speed Position Selection, Position / Speed mode switching, Speed / Torque mode switching, Torque / Position mode switching, Pt / Pr command switching, Emergency stop, Forward / Reverse inhibit limit, Reference "Home" sensor, Forward / Reverse operation torque limit, Move to "Home", Electronic cam, Forward / Reverse JOG input, Event trigger Pr command, Electronic gear ratio (Numerator) selection and Pulse inhibit input	
	Outputs		Encoder signal output (A, B, Z Line Driver and Z Open Collector ) Servo ready, Servo On, At Zero speed, At Speed reached, At Positioning completed, At Torques limit, Servo alarm (Servo fault) activated, Electromagnetic brake control, Homing completed, Output overload warning, Servo warning activated, Position command overflow, Forward / Reverse software limit, Internal position command completed, Capture operation completed output, Motion control completed output, Master position of E-CAM (electronic CAM)	
Protective Functions			Overcurrent, Overvoltage, Undervoltage, Motor overheated, Regeneration error, Overload, Overspeed, Abnormal pulse control command, Excessive deviation, Encoder error, Adjustment error, Emergency stop activated, Reverse/ Forward limit switch error, Position excessive deviation of full-close control loop, Serial communication error, Input power phase loss, Serial communication time out, short circuit protection of U, V, W, and CN1, CN2, CN3 terminals	
Communication Interface			RS-232 / RS-485 / CANopen / USB / DMNET	
Environment	Installation Site		Indoor location (avoid direct sunlight), no corrosive liquid and gas (avoid oil mist, flammable gas, dust)	
	Altitude		Altitude 1000m or lower above sea level	
	Atmospheric Pressure		86 kPa ~ 106 kPa	
	Operating Temperature		0°C ~ 55°C (If operating temperature is above 45°C, forced cooling will be required)	
	Storage Temperature		-20°C ~ 65°C	
	Humidity		0 ~ 90% RH (non-condensing)	
	Vibration		20 Hz or below 9.80665 m/s <sup>2</sup> (1G), 20 ~ 50Hz 5.88 m/s <sup>2</sup> (0.6 G)	
	IP Rating		IP20	
	Power System		TN System <sup>3</sup>	
Certifications		IEC/EN 61800-5-1, UL 508C	 	

\*1. Rated rotation speed: with a full load, speed ratio is defined as the minimum speed (the motor will not pause)

\*2. When command is rated rotation speed, the speed fluctuation rate is defined as: (Empty load rotation speed - Full load rotation speed) / Rated rotation speed

\*3. TN system: A power distribution system having one point directly earthed, the exposed conductive parts of the installation being connected to that point by a protective earth conductor

## Servo Drive and Servo Motor Combinations

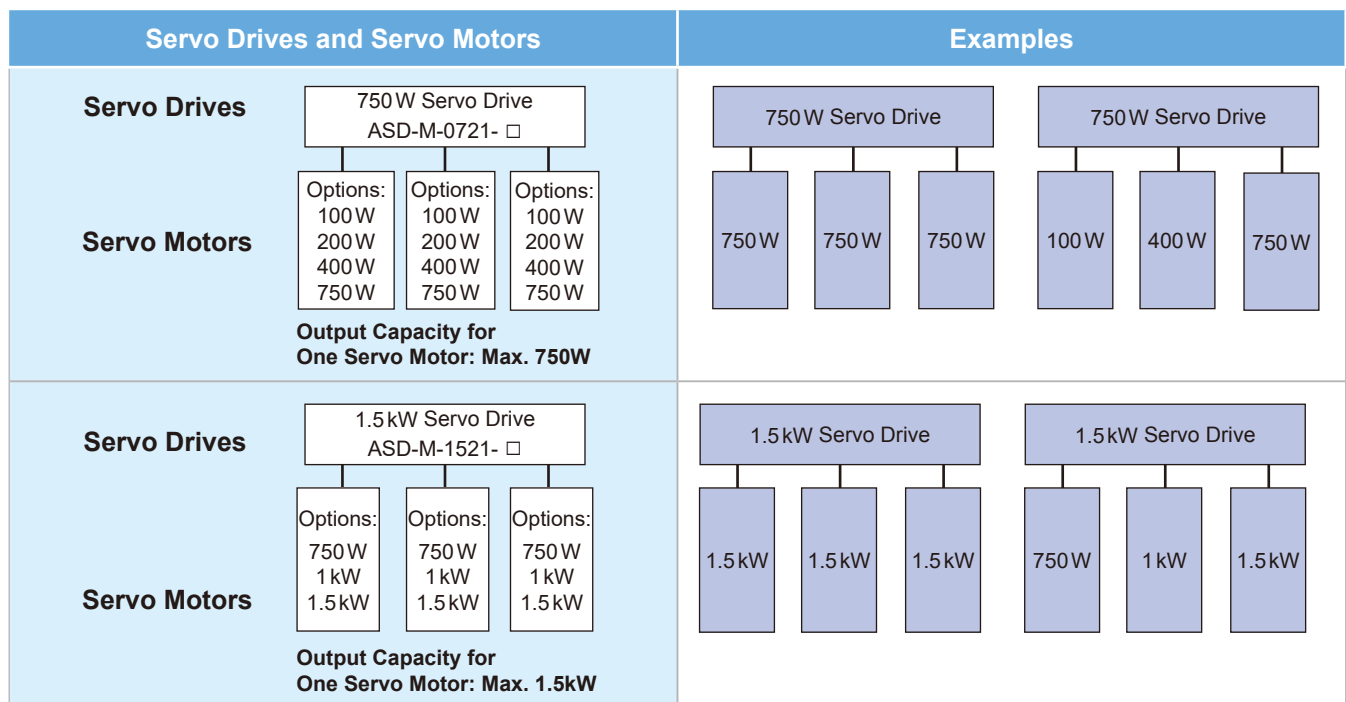

## General Signals of Connector CN1 (ASD-A3-F / ASD-A2-F / ASD-A2R-F / ASD-B2-F)

Signals	PIN No.			Description
	A2-F	A2R-F	B2-F	
DI1	PIN 9	PIN 9	PIN 1	Digital Inputs (Positive / Negative limit, Original point, Emergency stop), available to be set to meet users' requirements
DI2	PIN 10	PIN 10	PIN 2	
DI3	PIN 34	PIN 34	PIN 3	
DI4	PIN 8	PIN 8	PIN 4	
DI5	PIN 33	PIN 33	PIN 5	
DI6	PIN 32	PIN 32		
DI7	PIN 31	PIN 31		
DI8	PIN 30	PIN 30		
<b>Numbers</b>	<b>8</b>	<b>8</b>	<b>5</b>	
DO1+	PIN 7	PIN 7	PIN 12	Digital Outputs (Brake control), available to be set to meet users' requirements
DO1-	PIN 6	PIN 6	PIN 13	
DO2+	PIN 5	PIN 5	PIN 14	
DO2-	PIN 4	PIN 4	PIN 15	
DO3+	PIN 3	PIN 3		
DO3-	PIN 2	PIN 2		
DO4+	PIN 1	PIN 1		
DO4-	PIN 26	PIN 26		
DO5+	PIN 28	PIN 28		
DO5-	PIN 27	PIN 27		
<b>Numbers</b>	<b>5</b>	<b>5</b>	<b>2</b>	
OA+	PIN 21	PIN 21	PIN 7	Encoder signal output A, B, Z (Line Driver output)
OA-	PIN 22	PIN 22	PIN 8	
OB+	PIN 25	PIN 25	PIN 9	
OB-	PIN 23	PIN 23	PIN 10	
OZ+	PIN 50	PIN 50		
OZ-	PIN 24	PIN 24		
GND	PIN 13	PIN 13	PIN 6	VCC voltage based on GND
COM+	PIN 11	PIN 11	PIN 11	Common input for Digital Input (DI) voltage (positive end: connect to COM+; negative end: connect to COM-)
VDD	PIN 17	PIN 17		VDD is the +24V power provided by the drive and is for Digital Input (DI) and Digital Output (DO) signal (Max. current: 500mA)
COM-	PIN 45, 47, 49	PIN 45, 47, 49		Common input for Digital Input (DI) voltage (positive end: connect to COM+; negative end: connect to COM-)
DI (Digital Input): Internal Power Supply (DC 24V)	Internal and External Power Supply	Internal and External Power Supply	External Power Supply Only	

# Connector CN6 for DMCNET Communication (ASD-A3-F / ASD-A2-F / ASD-A2R-F / ASD-B2-F / ASD-M)

The CN6 communication connector adopts RJ45 joint and isolated cables for connecting Delta's motion control card directly to perform position, speed and torque control on the servo drives and monitor their status.

- Station numbers of DMCNET communication: same as RS-232 and RS-485; set by parameter P3-00 with transmission speed up to 20Mbps
- Provides two communication ports for transmission and receiving, convenient for direct connection of more than one servo drive in serial (connecting 120Ω termination resistor to the last servo drive needed)

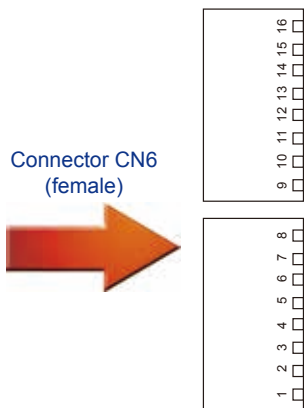

PIN No.	Signal Name	Description
1, 9	DMCNET_1A	DMCNET Channel 1 bus line (+)
2, 10	DMCNET_1B	DMCNET Channel 1 bus line (-)
3, 11	DMCNET_2A	DMCNET Channel 2 bus line (+)
4, 12	-	Reserved
5, 13	-	Reserved
6, 14	DMCNET_2B	DMCNET Channel 2 bus line (-)
7, 15	-	Reserved
8, 16	-	Reserved

※ Connecting method of termination resistor: Two 120Ω termination resistors are required. One is connected between DMCNET\_1A and DMCNET\_1B and the other is connected between DMCNET\_2A and DMCNET\_2B

## Monitoring Signals

ASDA-A2 or ASDA-B2

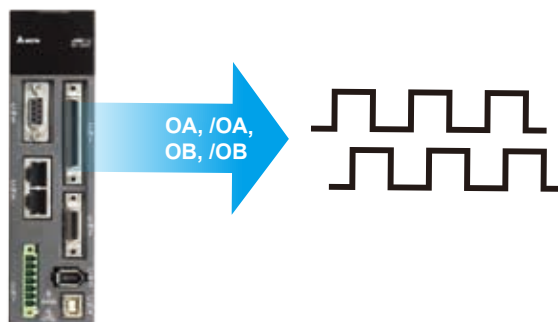

# EtherCAT Remote Modules

## Gateway Type E-bus Remote Power Coupler

R1-EC5500D0 / R1-EC5512D0

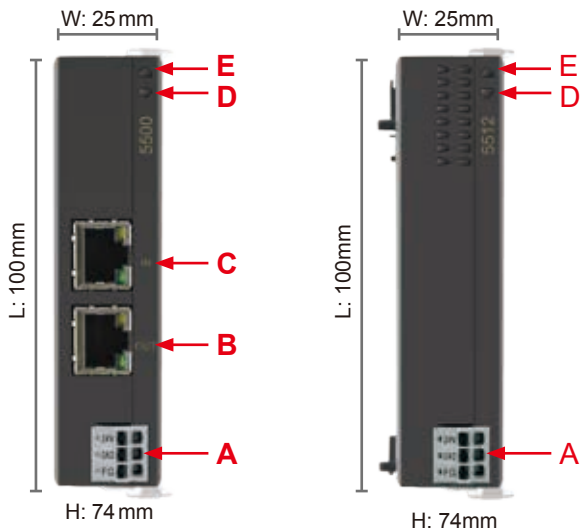

NO.	Description
A.	DC Power Input
B.	EtherCAT Output
C.	EtherCAT Input
D.	Status Indicator
E.	Power Indicator

Technical Data	R1-EC5500D0	R1-EC5512D0
Task Within EtherCAT System	Connect EtherCAT Slave module with 100baseTX EtherCAT	
Data Transfer Medium	Ethernet/EtherCAT cable (min. CAT 5), shielded	-
Distance Between Stations	100m (100BASE-TX) between two slaves	-
Protocol	EtherCAT	
Data Transfer Rates	100 Mbaud	
Bus Interface	RJ 45 x 2	-
Input Voltage	24 V <sub>DC</sub>	
Input Current	50 mA + (E-bus total E-bus current)/4	
Current Supply E-Bus	2A	
Electrical Isolation	500 Vrms (Power contact / Supply voltage / Ethernet)	
Vibration/Shock Resistance	EN 60068-2-6 / EN 60068-2-27 / 29	
EMC Immunity	ESD (IEC 61131-2, IEC 61000-4-2): 8 KV Air Discharge EFT (IEC 61131-2, IEC 61000-4-4): Power Line: 2KV Communication I/O: 1 KV RS (IEC 61131-2, IEC 61000-4-3): 80MHz ~ 1 GHz, 10V/m	
Operating Environment	Operating temperature: 0°C ~ 50°C Storage temperature: -20°C ~ 70°C	
Weight	55 g	
Protection Class	IP20	
Mounting Type	DIN-rail	

# 1-Channel Pulse Remote Module

## R1-EC5621D0

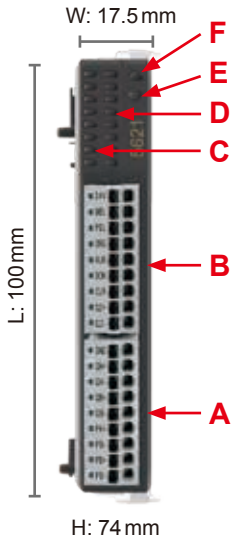

NO.	Description	No.	Description
A.	IO Signal Port	D.	IO Signal Indicator
B.	IO Signal Port	E.	Status Indicator
C.	IO Signal Indicator	F.	Power Indicator

Input	Description	Input	Description
24V	24V Power	GND	External Ground
MEL	End Limit (-)	QA+	Encoder A Phase (+)
PEL	End Limit (+)	QA-	Encoder A Phase (-)
ORG	Home Signal	QB+	Encoder B Phase (+)
ALM	Servo Alarm	QB-	Encoder B Phase (-)
SON	Servo On	PA+	Pulse Signal (+)
CLR	Reset Servo Alarm	PA-	Pulse Signal (-)
QZ+	Encoder Z Phase (+)	PB+	Dir. Signal (+)
QZ-	Encoder Z Phase (-)	PB-	Dir. Signal (-)

Technical Data	R1-EC5621D0
Number of Outputs	1 channel (PA+, PA-, PB+, PB-)
Number of Inputs	1 channel (QA+, QA-, QB+, QB-, QZ+, QZ-)
Power Supply	E-bus
Signal Voltage	RS422 Level
Max. Output Current	RS422 specification
Base Frequency	1Hz ~ 4MHz
Numbers Of 24 V Input	4 (MEL, PEL, ORG, ALM)
Numbers Of 24 V Output	2 (CLR, SON)
Trigger Voltage (On > Off)	< 8V <sub>DC</sub>
Trigger Voltage (Off > On)	> 16.5V <sub>DC</sub>
Maximum Current of Each Output Port	30mA
Current Consumption E-Bus	150mA
Electrical Isolation	500 Vrms (E-bus / field potential)
Bit Width in The Process Image	32 byte in/out (1 x 16 byte data, 1 x 16 byte control/status)
Vibration / Shock Resistance	EN 60068-2-6 / EN 60068-2-27 / 29
EMC Immunity	ESD (IEC 61131-2, IEC 61000-4-2): 8KV Air Discharge EFT (IEC 61131-2, IEC 61000-4-4): Power Line: 2KV Communication I/O: 1KV RS (IEC 61131-2, IEC 61000-4-3: 8MHz ~ 1GHz, 10V/m)
Operating Environment	Operating temperature: 0°C ~ 50°C ; Storage temperature: -20°C ~ 70°C
Weight	Approx. 60 g
Protection Class	IP20
Mounting Type	DIN-rail

# EtherCAT Remote Modules

## 16 Digital Input Remote Module

R1-EC6002D0 / R1-EC6022D0

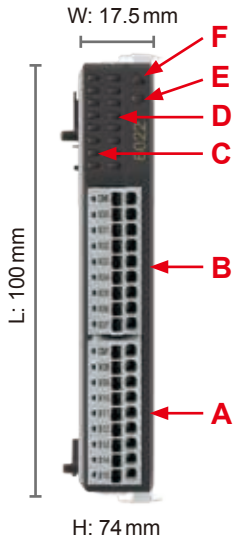

NO	Description	NO.	Description
A.	Port 1 Terminals	D.	Port 1 IO Signal X08~X15 (From the top)
B.	Port 0 Terminals	E.	Status Indicator
C.	Port 0 IO Signal X00~X07 (From the top)	F.	Power Indicator

Input	Description	Input	Description
CM0	Port 0 COM	CM1	Port1 COM
X00	Input 0	X08	Input 8
X01	Input 1	X09	Input 9
X02	Input 2	X10	Input 10
X03	Input 3	X11	Input 11
X04	Input 4	X12	Input 12
X05	Input 5	X13	Input 13
X06	Input 6	X14	Input 14
X07	Input 7	X15	Input 15

Technical Data	R1-EC6002D0	R1-EC6022D0
Connection Technology	single-ended	
Number of Inputs	16	
Nominal Voltage	24 V <sub>DC</sub> ± 10%	
Signal Type	SINK / SOURCE	
Trigger Voltage (On > Off)	< 8 V <sub>DC</sub>	
Trigger Voltage (Off > On)	> 16.5 V <sub>DC</sub>	
Input Filter	100µs	2ms
Input Current	3 mA at each port	
Current Consumption E-Bus	110 mA	
Electrical Isolation	500 V <sub>rms</sub> (E-bus / field potential)	
Bit Width in The Process Image	16 inputs	
Vibration/Shock Resistance	EN 60068-2-6 / EN 60068-2-27 / 29	
EMC Immunity	ESD (IEC 61131-2, IEC 61000-4-2): 8 KV Air Discharge EFT (IEC 61131-2, IEC 61000-4-4): Power Line: 2KV Communication I/O: 1KV RS (IEC 61131-2, IEC 61000-4-3): 80 MHz ~ 1 GHz, 10V/m	
Operating Environment	Operating temperature: 0°C ~ 50°C; Storage temperature: -20°C ~ 70°C	
Weight	55 g	
Protection Class	IP20	
Mounting Type	DIN-rail	



## 16-Channel Output Remote Module

R1-EC7062D0 / R1-EC70E2D0 / R1-EC70A2D0 / R1-EC70F2D0

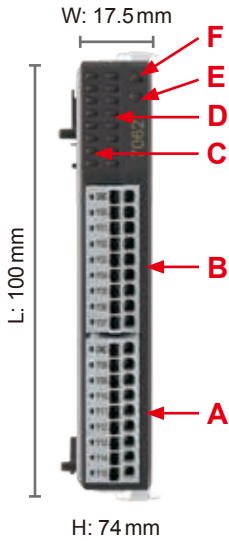

NO.	Description	NO.	Description
A.	Port 1 Terminals	D.	Port 1 IO Signal Y08~Y15 (From the top)
B.	Port 0 Terminals	E.	Status Indicator
C.	Port 0 IO Signal Y00~Y07 (From the top)	F.	Power Indicator

Output	Description	Output	Description
GND *	Port 0 GND	GND	Port 1 GND
24V **	Port 0 24V Power Input		
Y00	Output 0	Y08	Output 8
Y01	Output 1	Y09	Output 9
Y02	Output 2	Y10	Output 10
Y03	Output 3	Y11	Output 11
Y04	Output 4	Y12	Output 12
Y05	Output 5	Y13	Output 13
Y06	Output 6	Y14	Output 14
Y07	Output 7	Y15	Output 15

\*R1-EC7062D0 / R1-EC70E2D0

\*\*R1-EC70A2D0 / R1-EC70F2D0

Technical Data	R1-EC7062D0	R1-EC70E2D0	R1-EC70A2D0	R1-EC70F2D0
Connection Technology	MOSFET			
Signal Type	SINK		SOURCE	
Nominal Voltage	24 V <sub>DC</sub>			
Maintains Shortage Output	×	√	×	√
Output Current	0.5A (Max.)		0.25A (Max.)	
Current Consumption E-Bus	120mA	200mA		
Response Time / Frequency	1 KHz			
Trigger Time (Off > On)	140us		160us	
Trigger Time (On > Off)	150us		110us	
EMC Immunity	ESD (IEC 61131-2, IEC 61000-4-2): 8 KV Air Discharge EFT (IEC 61131-2, IEC 61000-4-4): Power Line: 2 KV Communication I/O: 1 KV RS (IEC 61131-2, IEC 61000-4-3): 80 MHz ~ 1 GHz, 10 V/m			
Operating Environment	Operating temperature: 0 °C ~ 50 °C; Storage temperature: -20 °C ~ 70 °C			
Weight	Approx. 60 g			
Protection Class	IP20			
Mounting Type	DIN-rail			

# EtherCAT Remote Modules

## 4-Channel Analog Input Remote Module

R1-EC8124D0

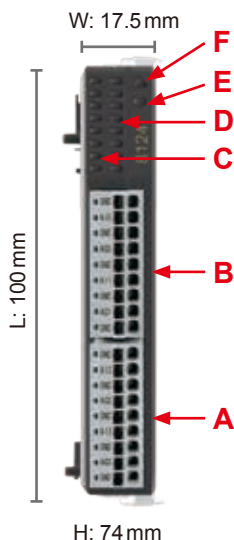

NO.	Description	NO.	Description
A.	CH3/CH4 Signal port	D.	CH3/CH4 Signal Indicator
B.	CH1/CH2 Signal port	E.	Status Indicator
C.	CH1/CH2 Signal Indicator	F.	Power Indicator

Input	Description	Input	Description
GND	Analog Ground	GND	Analog Ground
AI0	CH1 Voltage /Current Input	AI2	CH3 Voltage / Current Input
GND	Analog Ground	GND	Analog Ground
AG0	CH1 Current COM*	AG2	CH3 Current COM*
GND	Analog Ground	GND	Analog Ground
AI1	CH2 Voltage / Current Input	AI3	CH4 Voltage / Current Input
GND	Analog Ground	GND	Analog Ground
AG1	CH2 Current COM*	AG3	CH4 Current COM*
GND	Analog Ground	GND	Analog Ground

\* In current mode: please connect current COM to GND; in voltage mode: please disconnect this COM

Technical Data	R1-EC8124D0
Number of Inputs	4 (single-ended)
Power Supply	via the E-bus
Signal Voltage	$\pm 10V / \pm 5V$
Internal Resistance	$> 1M\Omega$
Input Filter Limit Frequency	1 KHz ~ 10 KHz
Resolution	16 bit
Over Sampling Rate	0 ~ 64
Conversion Time	2 us ~ 191 us (depends on Over Sampling Rate)
Measuring Error	$< \pm 0.2\%$ (relative to full scale value)
Electrical Isolation	1000 Vrms (E-bus / signal voltage)
Current Consumption E-Bus	300 mA
Bit Width in The Process Image	input : 4 x 16 byte data, 4 x 16 byte control/status
Vibration/Shock Resistance	EN 60068-2-6 / EN 60068-2-27 / 29
EMC Immunity	ESD (IEC 61131-2, IEC 61000-4-2): 8 KV Air Discharge EFT (IEC 61131-2, IEC 61000-4-4): Power Line: 2KV Communication I/O: 1KV RS (IEC 61131-2, IEC 61000-4-3): 8 MHz ~ 1 GHz, 10V/m
Operating Environment	Operating temperature: 0°C ~ 50°C ; storage temperature: -20°C ~ 70°C
Weight	Approx. 60 g (0.13 lbs)
Protection Class	IP20
Mounting Type	DIN-rail

## 4-Channel Analog Output Remote Module

### R1-EC9144D0

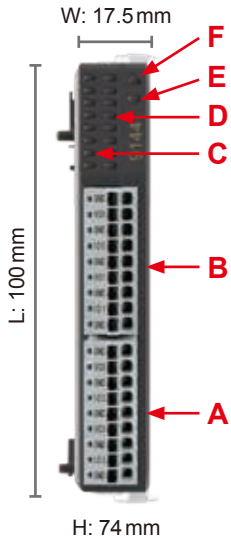

NO.	Description	NO.	Description
A.	CH3/CH4 Signal port	D.	CH3/CH4 Signal Indicator
B.	CH1/CH2 Signal port	E.	Status Indicator
C.	CH1/CH2 Signal Indicator	F.	Power Indicator

Output	Description	Output	Description
GND	Analog Ground	GND	Analog Ground
VO0	CH1 Voltage Output	VO2	CH3 Voltage Output
GND	Analog Ground	GND	Analog Ground
IO0	CH1 Current Output	IO2	CH3 Current Output
GND	Analog Ground	GND	Analog Ground
VO1	CH2 Voltage Output	VO3	CH4 Voltage Output
GND	Analog Ground	GND	Analog Ground
IO1	CH2 Current Output	IO3	CH4 Current Output
GND	Analog Ground	GND	Analog Ground

Technical Data	R1-EC9144D0
Number of Inputs	4 (single-ended)
Power Supply	via the E-bus
Signal Voltage Output	$\pm 10V / \pm 5V / 0 \sim 5V / 0 \sim 10V$
Current Output	$0 \sim 20 \text{ mA} / 4 \sim 24 \text{ mA} / 0 \sim 24 \text{ mA}$
Load	$> 1 \text{ K}\Omega$ (short-circuit-proof)
Resolution	16 bit
Conversion Time	80us
Measuring Error	$< \pm 0.2 \%$ (relative to full scale value) Output Voltage $< \pm 0.3 \%$ (relative to full scale value) Current Output
Electrical Isolation	1000 Vrms (E-bus / signal voltage)
Current Consumption E-Bus	550 mA
Bit Width in The Process Image	Output: 4 x 16 byte, (4 x 16-bit analog output)
Vibration/Shock Resistance	EN 60068-2-6 / EN 60068-2-27 / 29
EMC Immunity	ESD (IEC 61131-2, IEC 61000-4-2): 8KV Air Discharge EFT (IEC 61131-2, IEC 61000-4-4): Power Line: 2KV Communication I/O: 1KV RS (IEC 61131-2, EC 61000-4-3): 8MHz ~ 1 GHz, 10V/m
Operating Environment	Operating temperature: $0^{\circ}\text{C} \sim 50^{\circ}\text{C}$ ; Storage temperature: $-20^{\circ}\text{C} \sim 70^{\circ}\text{C}$
Weight	Approx. 60 g
Protection Class	IP20
Mounting Type	DIN-rail

# EtherCAT Remote Modules

## Manual Pulse Generator (MPG) Module

R1-EC5614D0

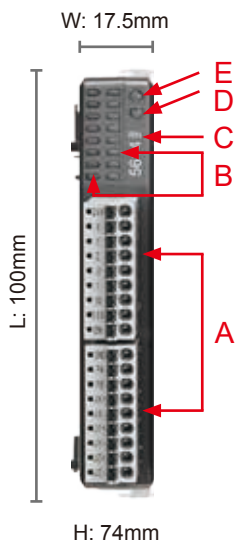

NO.	Description	NO.	Description
A.	IO Signal Port	D.	Status Indicator
B.	IO Signal Indicator	E.	Power Indicator
C.	Product No.		



Input	Description	Input	Description
GND	External Ground	24V	External Power Input
PA	MPG Pulse Phase A Input	X	X-axis Pulse Chosen Signal
PB	MPG Pulse Phase B Input	Y	Y-axis Pulse Chosen Signal
JX+	JOG X-axis Signal (+)	Z	Z-axis Pulse Chosen Signal
JX-	JOG X-axis Signal (-)	U	U-axis Pulse Chosen Signal
JY+	JOG Y-axis Signal (+)	1	Pulse magnification (x 1)
JY-	JOG Y-axis Signal (-)	10	Pulse magnification (x 10)
JZ+	JOG Z-axis Signal (+) / *W-axis	100	Pulse magnification (x 100)
JZ-	JOG Z-axis Signal (-) / *V-axis	EN	Motion / Setting Execution

\*Supports 6-axis MPG via software: JZ+ needs to connect to W-axis signal; JZ- needs to connect to V-axis signal

Technical Data	R1-EC5614
Control Axes	4 / 6 axes
Power Supply	via the E-bus
Pulse Magnification	x 1 / x 10 / x 100
JOG Input	3 / 2 sets
Sampling Rate	40KHz
FIFO Length	30 sets
Communication Time	125us - 3276800us
Trigger Time (ON > OFF)	< 8V <sub>DC</sub>
Trigger Time (OFF > ON)	> 16.5V <sub>DC</sub>
Current Consumption E-Bus	180mA
Electrical Isolation	500 Vrms (E-BUS / Signal Power)
Vibration / Shock Resistance	EN 60068-2-6 / EN 60068-2-27 / 29
EMC Immunity	ESD (IEC 61131-2, IEC 61000-4-2) EFT (IEC 61131-2, IEC 61000-4-4) RS (IEC 61131-2, EC 61000-4-3)
Operating Environment	Operating temperature: 0 °C ~ 50 °C Storage temperature: -20 °C ~ 70 °C
Weight	Approx. 55 g
Protection Class	IP20
Safety Certification	CE
Mounting Type	DIN-rail

# ASDA-A2-E EtherCAT Servo Drive Specifications

## 220 V Series

ASDA A2-E Series		100 W	200 W	400 W	750 W	1 kW	1.5 kW	2 kW	3 kW	
		01	02	04	07	10	15	20	30	
Power Supply	Phase / Voltage	Three-phase / Single-phase 220 V <sub>AC</sub>						Three-phase 220 V <sub>AC</sub>		
	Permissible Voltage Range	Three-phase / Single-phase 200 ~ 230 V <sub>AC</sub> , -15% ~ 10%						Three-phase 200 ~ 230 V <sub>AC</sub> , -15% ~ 10%		
Input Current (3PH) Unit: Arms		0.39	1.11	1.86	3.66	4.68	5.9	8.76	9.83	
Input Current (1PH) Unit: Arms		0.69	1.92	3.22	6.78	8.88	10.3	-	-	
Continuous Output Current Unit: Arms		0.9	1.55	2.6	5.1	7.3	8.3	13.4	19.4	
Cooling Method		Natural Air Circulation			Fan Cooling					
Encoder Resolution (Servo Drive Resolution)		Incremental type: 20-bit (1280000 p/rev) ; Absolute type: 17-bit								
Control of Main Circuit		SVPWM (Space Vector Pulse Width Modulation) Control								
Tuning Modes		Auto / Manual								
Dynamic Brake		Built-in								
Position Control Mode (CSP)	Command Source	External analog signal								
	Smoothing Strategy	Low-pass and P-curve filter								
	Electronic Gear	Electronic gear N/M multiple N: 1 ~ 32767, M: 1 : 32767 (1/50 < N/M < 25600)								
	Torque Limit Operation	External analog signal								
Speed Control Mode (CSV)	Feed Forward Compensation	External analog signal / Internal parameters								
	Speed Control Range <sup>1</sup>	1 : 5000						1 : 3000		
	Command Source	External analog signal								
	External Analog Signal	External analog signal								
	Smoothing Strategy	Low-pass and S-curve filter								
	Torque Limit Operation	Set by parameters or via analog input								
	Frequency Response Characteristic	Max. 1 kHz								
Speed Accuracy (at rated rotation speed) <sup>2</sup>		0.01% or less at 0 ~ 100% load fluctuation								
		0.01% or less at 0°C ~ 50°C ambient temperature fluctuation								
Feed Forward Compensation		0.01% or less at ±10% power fluctuation								
Torque Control Mode (CST)	Command Source	External analog signal								
	Smoothing Strategy	Low-pass filter								
	Speed Limit Operation	Via analog input								
Digital Inputs/Outputs	Inputs	Servo on, Reset, Gain switching, Pulse clear, Zero speed CLAMP, Command input reverse control, Command triggered, Speed/Torque limit enabled, Position command selection, Motor stop, Speed position selection, Position / Speed mode switching, Speed / Torque mode switching, Torque / Position mode switching, PT / PR command switching, Emergency stop, Forward / Reverse inhibit limit, Reference "Home" sensor, Forward / Reverse operation torque limit, Move to "Home" , Electronic Cam (E-Cam), Forward / Reverse JOG input, Event trigger PR command, Electronic gear ratio (Numerator) selection and Pulse inhibit input								
	Outputs	Encoder signal output (A, B, Z Line Driver and Z Open Collector ) Servo ready, Servo on, At Zero speed, At Speed reached, At Positioning completed, At Torques limit, Servo alarm (Servo fault) activated, Electromagnetic brake control, Homing completed, Output overload warning, Servo warning activated, Position command overflow, Forward / Reverse software limit, Internal position command completed, Capture operation completed output., Motion control completed output., Master position of E-Cam (Electronic Cam)								
Protective Functions		Overcurrent, Overvoltage, Undervoltage, Motor overheated, Regeneration error, Overload, Overspeed, Abnormal pulse control command, Excessive deviation, Encoder error, Adjustment error, Emergency stop activated, Reverse/ Forward limit switch error, Position excessive deviation of full-close control loop, Serial communication error, Input power phase loss, Serial communication time out, short circuit protection of U, V, W, and CN1, CN2, CN3 terminals								
Communication Interface		USB / EtherCAT								
Environment	Installation Site	Indoor location (avoid direct sunlight), no corrosive liquid and gas (avoid oil mist, flammable gas, dust)								
	Altitude	Altitude 1000 m or lower above sea level								
	Atmospheric Pressure	86 kPa ~ 106 kPa								
	Operating Temperature	0°C ~ 55°C (If operating temperature is above 45°C, forced cooling will be required)								
	Storage Temperature	-20°C ~ 65°C (-4°F ~ 149°F)								
	Humidity	0 ~ 90% RH (non-condensing)								
	Vibration	9.80665 m/s <sup>2</sup> (1 G) less than 20 Hz, 5.88 m/s <sup>2</sup> (0.6 G) 20 ~ 50 Hz								
	IP Rating	IP20								
Power System	TN System <sup>3</sup>									
Certifications		IEC/EN 61800-5-1, UL 508C, C-tick   								

<sup>1</sup> Rated rotation speed: When full load, speed ratio is defined as the minimum speed (the motor will not pause)

<sup>2</sup> When command is rated rotation speed, the speed fluctuation rate is defined as: (Empty load rotation speed – Full load rotation speed) / Rated rotation speed

<sup>3</sup> TN system: A power distribution system having one point directly earthed, the exposed conductive parts of the installation being connected to that point by a protective earth conductor

# ASDA-A2-E EtherCAT Servo Drive Specifications

## 400 V Series

ASDA A2-E Series		400 W	750 W	1 kW	1.5 kW	2 kW	3 kW	4.5 kW	5.5 kW	7.5 kW
		04	07	10	15	20	30	45	55	75
Power Supply	Input Voltage	24 V <sub>DC</sub> , ±10%								
	Input Current	0.43 A			1.18 A			1.66 A		
	Input Power	10.32 W			28.2 W			39.85 W		
Main Circuit Power		Three-phase, 380 ~ 480 V <sub>AC</sub> , ±10%								
Input Current	Unit: Arms	1.40	2.35	3.02	4.24	5.65	8.01	11.9	14.1	17.27
Continuous Output Current	Unit: Arms	2.0	3.35	3.52	5.02	6.66	11.9	20	22.37	30
Cooling Method		Fan Cooling								
Encoder Resolution (Servo Drive Resolution)		Incremental type: 20-bit (1280000 p/rev); Absolute type: 17-bit								
Control of Main Circuit		SVPWM (Space Vector Pulse Width Modulation) Control								
Tuning Modes		Auto / Manual								
Dynamic Brake		Built-in								
Position Control Mode (CSP)	Command Source	External analog signal								
	Smoothing Strategy	Low-pass and P-curve filter								
	Electronic Gear	Electronic gear N/M multiple N: 1 ~ 32767, M: 1 : 32767 (1/50 < N/M < 25600)								
	Torque Limit Operation	External analog signal								
	Feed Forward Compensation	External analog signal / Internal parameters								
Speed Control Mode (CSV)	Speed Control Range <sup>*1</sup>	1 : 5000						1 : 3000		
	Command Source External Analog Signal	External analog signal								
	Smoothing Strategy	Low-pass and S-curve filter								
	Torque Limit Operation	Set by parameters or via analog input								
	Frequency Response Characteristic	Max. 1 kHz								
	Speed Accuracy (at rated rotation speed) <sup>*2</sup>	0.01% or less at 0 ~ 100% load fluctuation 0.01% or less at 0°C ~ 50°C ambient temperature fluctuation								
	Feed Forward Compensation	0.01% or less at ±10% power fluctuation								
Torque Control Mode (CST)	Command Source	External analog signal								
	Smoothing Strategy	Low-pass filter								
	Speed Limit Operation	Via analog input								
Digital Inputs/Outputs	Inputs	Servo on, Reset, Gain switching, Pulse clear, Zero speed CLAMP, Command input reverse control, Command triggered, Speed/Torque limit enabled, Position command selection, Motor stop, Speed position selection, Position / Speed mode switching, Speed / Torque mode switching, Torque / Position mode switching, PT / PR command switching, Emergency stop, Forward / Reverse inhibit limit, Reference "Home" sensor, Forward / Reverse operation torque limit, Move to "Home", Electronic Cam (E-Cam), Forward / Reverse JOG input, Event trigger PR command, Electronic gear ratio (Numerator) selection and Pulse inhibit input								
	Outputs	Encoder signal output (A, B, Z Line Driver and Z Open Collector) Servo ready, Servo on, At Zero speed, At Speed reached, At Positioning completed, At Torques limit, Servo alarm (Servo fault) activated, Electromagnetic brake control, Homing completed, Output overload warning, Servo warning activated, Position command overflow, Forward / Reverse software limit, Internal position command completed, Capture operation completed output., Motion control completed output., Master position of E-Cam (Electronic Cam)								
Protective Functions		Overcurrent, Overvoltage, Undervoltage, Motor overheated, Regeneration error, Overload, Overspeed, Abnormal pulse control command, Excessive deviation, Encoder error, Adjustment error, Emergency stop activated, Reverse/ Forward limit switch error, Position excessive deviation of full-close control loop, Serial communication error, Input power phase loss, Serial communication time out, short circuit protection of U, V, W, and CN1, CN2, CN3 terminals								
Communication Interface		USB / EtherCAT								
Environment	Installation Site	Indoor location (avoid direct sunlight), no corrosive liquid and gas (avoid oil mist, flammable gas, dust)								
	Altitude	Altitude 1000 m or lower above sea level								
	Atmospheric Pressure	86 kPa ~ 106 kPa								
	Operating Temperature	0°C ~ 55°C (If operating temperature is above 45°C, forced cooling will be required)								
	Storage Temperature	-20°C ~ 65°C (-4°F ~ 149°F)								
	Humidity	0 ~ 90% RH (non-condensing)								
	Vibration	9.80665 m/s <sup>2</sup> (1 G) less than 20 Hz, 5.88 m/s <sup>2</sup> (0.6 G) 20 ~ 50 Hz								
	IP Rating	IP20								
	Power System	TN System <sup>*3</sup>								
Certifications	IEC/EN 61800-5-1, UL 508C, C-tick									

\*1 Rated rotation speed: When full load, speed ratio is defined as the minimum speed (the motor will not pause)

\*2 When command is rated rotation speed, the speed fluctuation rate is defined as: (Empty load rotation speed - Full load rotation speed) / Rated rotation speed

\*3 TN system: A power distribution system having one point directly earthed, the exposed conductive parts of the installation being connected to that point by a protective earth conductor



# Communication Specifications

<b>Physical Layer</b>	IEEE802.3u (100 BASE-TX)
<b>Data Link Layer</b>	APRD, FPRD, BRD, LRD, APWR, FPWR, BWR, LWR, ARMW, FRMW, APRW, FPRW, BRW, LRW
<b>Device Profile (CiA402)</b>	Homing Mode, Profile Position Mode, Profile Velocity Mode, Profile Torque Mode, Interpolated Position Mode, Cyclic Syn. Position Mode, Cyclic Syn. Velocity Mode, Cyclic Syn. Torque Mode, Touch Probe Function, Torque Limit Function
<b>Process Data Size</b>	Tx: 8 object (32 byte, Max.) Rx: 8 object (32 byte, Max.); Dynamic Mapping supported
<b>Bus Clock</b>	DC cycle with min. 250 us*
<b>LED Indicator</b>	EtherCAT Link/Activity Indicator (L/A) x 2 EtherCAT RUN Indicator (RUN) x 1 EtherCAT ERROR Indicator (ERR) x 1

\* This function will be available in a new version soon

# Accessories for ASDA-A2-E

<b>Part Number</b>	ASD-CN5C0026
<b>Description</b>	CN1 connector



<b>Part Number</b>	ASD-CNFS0808
<b>Description</b>	Pack of connectors used for STO wiring, 8 pcs of connectors in one pack



# Part Names and Functions

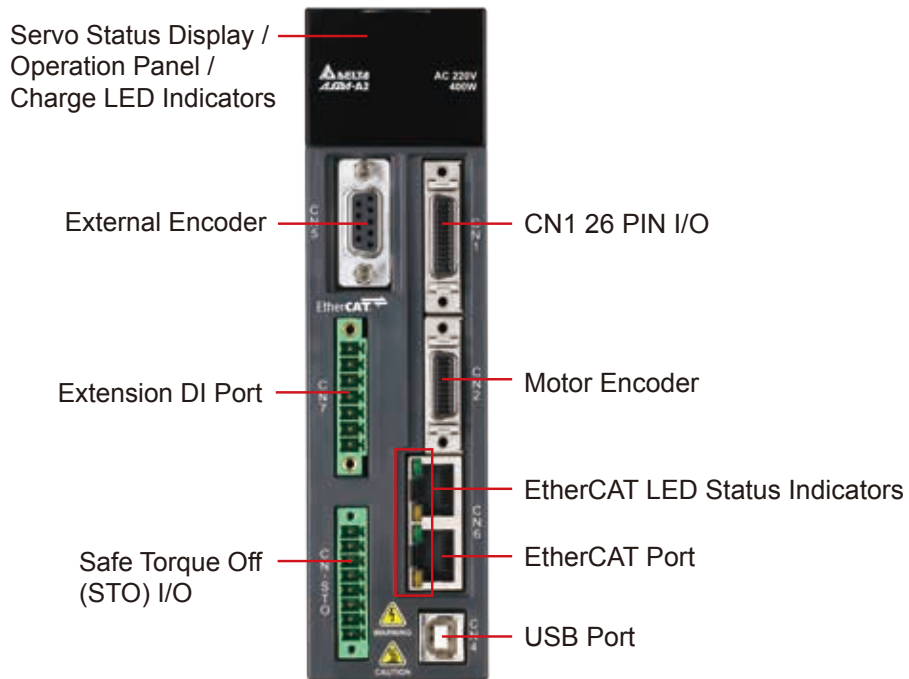

# Ordering Information

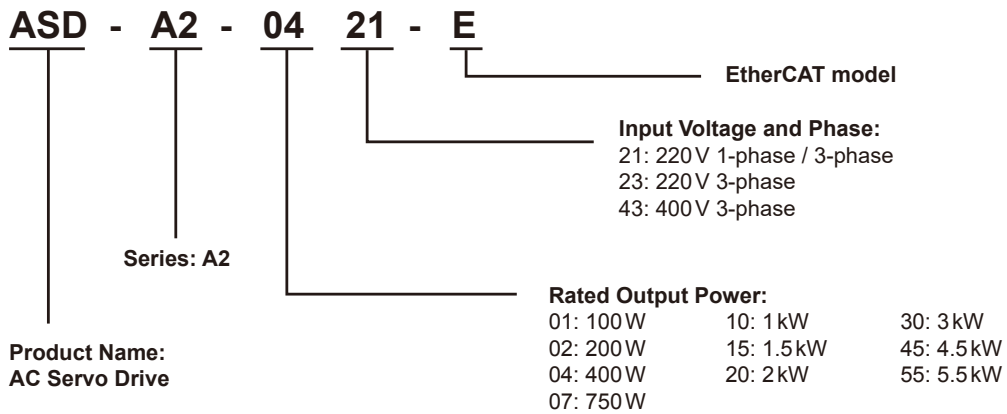



# Ordering Information

Programmable Automation Controllers - Motion Control Host PAC											
Model Name	CPU Type	Storage	Slot Interface	RAM	OS	Motion Protocol	Development Tool	Note			
MH1-A12D-A03DG	Atom E3845 Quad Core 1.91GHz	2 PCI	32GB CFast	4GB	Win 7 32bit	DMCNET	API				
MH1-A12D-A03DM							IMP				
MH1-A12D-A05DG			128GB SSD				API				
MH1-C50D-A03DG	Core i5-3610ME Dual Core 2.7GHz	2 PCI	32GB Cfast	4GB	Win 7 32bit	DMCNET	API				
MH1-C50D-A03DM				IMP							
MH1-C50D-A33DH				8GB	Win 7 64bit		API				
MH1-C50D-A04DG			64GB SSD	API							
MH1-C50D-C03DG			PCIe (x4+x1)	32GB CFast	4GB		Win 7 32bit	API			
MH1-C70D-A03DG	Core i7-3612QE Quad Core 2.1GHz	2 PCI	32GB CFast	4GB	Win 7 32bit	DMCNET	API				
MH1-C70D-A03DM				IMP							
MH1-C70D-A33DH				8GB	Win 7 64bit		API				
MH1-C70D-C03DG			PCIe (x4+x1)	4GB	Win 7 32bit		API				
MH1-C70D-C33DH			4GB	Win 7 64bit	API						
MH1-A12N-A03DG	Atom E3845 Quad Core 1.91GHz	2 PCI	32GB CFast	4GB	Win 7 32bit	NA	NA				
MH1-A12N-A05DG			128GB SSD								
MH1-C50N-A03DG	Core i5-3610ME Dual Core 2.7GHz	2 PCI	32GB CFast	4GB	Win 7 32bit	NA	NA				
MH1-C50N-A05DG			128GB SSD								
MH1-C50N-C03DG			PCIe (x4+x1)					32GB CFast	8GB	Win 7 64bit	
MH1-C50N-C33DH			8GB					Win 7 64bit			
MH1-C70N-A03DG	Core i7-3612QE Quad Core 2.1GHz	2 PCI	32GB CFast	4GB	Win 7 32bit	NA	NA				
MH1-C70N-C03DG		PCIe (x4+x1)		8GB	Win 7 64bit						
MH1-C70N-C33DH		8GB		Win 7 64bit							
MH2-P10N-N06DJ	Celeron J1900 Quad Core 2.4GHz	NA	32GB SSD	4GB	Win10 64bit	EtherCAT	API	2019.Q3 Available			
MH2-P10N-N06DL							IMP	2019.Q3 Available			
MH2-P10N-N06DN							CODESYS	2019.Q2 Available			
MH2-P10N-P06DN								2019.Q2 Available			

Programmable Automation Controllers - Motion Control Panel PC								
Model Name	CPU Type	Monitor	Slot Interface	RAM	OS	Motion Protocol	Development Tool	Note
MP1-A10D-1012DG	Atom E3825 Dual Core 1.33GHz	10.1"	16GB SSD	2GB	Win 7 32bit	DMCNET	API	
MP1-A10D-1012DM							IMP	
MP1-A12D-1503DG	Atom E3845 Quad Core 1.91GHz	15"	32GB CFast	4GB	Win 7 32bit	DMCNET	API	
MP1-A12D-1503DM							IMP	
MP1-A12D-1505DG			128GB SSD				API	
MP1-P10D-1505DJ	Celeron J1900 Quad Core 2.4GHz				Win10 64bit		API	2019.Q3 Available
MP1-P10D-1505DL							IMP	2019.Q3 Available

## Ordering Information

Motion Control Cards	
PCI-DMC-A02	DMCNET Standard Type Motion Control Card with Local I/O (32 DI / 24 DO)
PCI-DMC-B01	DMCNET Advanced Type Motion Control Card with 2 Groups of Pulse Compare
PCI-DMC-B02	DMCNET Advanced Motion Control Card + 2D Pulse Compare
PCI-DMC-B03	DMCNET Advanced Motion Control Card + 3 Sets of Pulse Compare & 10 Sets of DO
PCI-DMC-F02	DMCNET Economic Type Motion Control Card with Local I/O (32 DI / 24 DO)
PCIe-L221-B1D0	EtherCAT Advanced Motion Control Card + 2 Sets of Pulse Compare
PCI-L221-P1D0	EtherCAT Standard Type Motion Control Card
PCI-L221-B1D0	EtherCAT Advanced Type Motion Control Card with 2 Groups of Pulse Compare
PCI-M324-F1D0	4-axis Pulse Motion Control Card
PCI-D122-XND0	32IN/32OUT Digital Signal Capture Card
DB-D1XX-01D0	Digital Signal Capture Slave Card
DMCNET Remote Modules	
ASD-DMC-RM32MN	32 Digital Input Remote Module (NPN / PNP)
ASD-DMC-RM64MN	64 Digital Input Remote Module (NPN / PNP) plus MPG Module
ASD-DMC-RM32NT	32 Digital Output Remote Module
ASD-DMC-RM64NT	64 Digital Output Remote Module
ASD-DMC-RM32PT	32 Digital I/O Remote Module with 16 DI (NPN / PNP) & 16 DO (Transistor Output)
ASD-DMC-RM04PI	4-Channel Pulse Remote Module (4 Channels of 200 kHz Pulse Outputs and Inputs)
ASD-DMC-RM04AD	4-Channel Analog Input Module
ASD-DMC-RM04DA	4-Channel Analog Output Module
HMC-RIO3232RT5	Digital I/O Remote Module with 32 DI (NPN / PNP), 16 DO (Relay Output) & 16 DO (Transistor Output)
DMCNET Gateway Type Remote Modules	
ASD-DMC-GA01	DMCNET Gateway Type Remote Power Coupler
ASD-DMC-GE01PH	DMCNET Gateway Type Pulse Output Remote Module (1-Channel of 4M High-speed Pulse Interface)
EtherCAT Remote Modules	
R1-EC5500D0	E-BUS Remote Power Coupler
R1-EC5512D0	E-BUS Remote Power Coupler (without communication network interface)
R1-EC5621D0	1-Channel Pulse Output Remote Module
R1-EC5614D0	MPG Extension Module
R1-EC6002D0	16-channel Digital Input Remote Module (NPN / PNP)
R1-EC6022D0	16-Channel Input Remote Module (NPN / PNP); response time 2ms
R1-EC7062D0	16-Channel Digital Output Remote Module (NPN)
R1-EC70A2D0	16-Channel Digital Output Remote Module (PNP)

### EtherCAT Remote Modules

R1-EC70E2D0	16-Channel Digital Output Remote Module (NPN)
R1-EC70F2D0	16-Channel Digital Output Remote Module (PNP)
R1-EC8124D0	4-Channel Analog Input Remote Module
R1-EC9144D0	4-Channel Analog Output Remote Module
R1-EC5614D0	MPG Module

### IPC Motion Platform (IMP)

IMPBSC-MCD01	Standard Version of IPC Motion Platform (IMP)
--------------	---

### ASDA-A2-F DMCNET Servo Drives

ASD-A2-0121-F	A2 220V 1-Phase/3-Phase 100W DMCNET Servo Drive
ASD-A2-0221-F	A2 220V 1-Phase/3-Phase 200W DMCNET Servo Drive
ASD-A2-0421-F	A2 220V 1-Phase/3-Phase 400W DMCNET Servo Drive
ASD-A2-0721-F	A2 220V 1-Phase/3-Phase 750W DMCNET Servo Drive
ASD-A2-1021-F	A2 220V 1-Phase/3-Phase 1.0kW DMCNET Servo Drive
ASD-A2-1521-F	A2 220V 1-Phase/3-Phase 1.5kW DMCNET Servo Drive
ASD-A2-2023-F	A2 220V 3-Phase 2.0kW DMCNET Servo Drive
ASD-A2-3023-F	A2 220V 3-Phase 3.0kW DMCNET Servo Drive
ASD-A2-4523-F	A2 220V 3-Phase 4.5kW DMCNET Servo Drive
ASD-A2-5523-F	A2 220V 3-Phase 5.5kW DMCNET Servo Drive
ASD-A2-7523-F	A2 220V 3-Phase 7.5kW DMCNET Servo Drive

### ASDA-B2-F DMCNET Servo Drives

ASD-B2-0121-F	B2 220V 1-Phase/3-Phase 100W DMCNET Servo Drive
ASD-B2-0221-F	B2 220V 1-Phase/3-Phase 200W DMCNET Servo Drive
ASD-B2-0421-F	B2 220V 1-Phase/3-Phase 400W DMCNET Servo Drive
ASD-B2-0721-F	B2 220V 1-Phase/3-Phase 750W DMCNET Servo Drive
ASD-B2-1021-F	B2 220V 1-Phase/3-Phase 1.0kW DMCNET Servo Drive
ASD-B2-1521-F	B2 220V 1-Phase/3-Phase 1.5kW DMCNET Servo Drive
ASD-B2-2023-F	B2 220V 3-Phase 2.0kW DMCNET Servo Drive
ASD-B2-3023-F	B2 220V 3-Phase 3.0kW DMCNET Servo Drive

## Ordering Information

ASDA-A2R-F DMCNET Servo Drives	
ASD-A2R-0121-F	A2R 220 V 1-Phase/3-Phase 100 W DMCNET Servo Drive
ASD-A2R-0221-F	A2R 220 V 1-Phase/3-Phase 200 W DMCNET Servo Drive
ASD-A2R-0421-F	A2R 220 V 1-Phase/3-Phase 400 W DMCNET Servo Drive
ASD-A2R-0721-F	A2R 220 V 1-Phase/3-Phase 750 W DMCNET Servo Drive

ASDA-M DMCNET Servo Drives	
ASD-M-0721-F	M 220 V 1-Phase/3-Phase 750 W DMCNET Servo Drive
ASD-M-1521-F	M 220 V 1-Phase/3-Phase 1.2 kW DMCNET Servo Drive

ASDA-A2-E EtherCAT Servo Drives - 220 V Series	
ASD-A2-0121-E	A2 220 V 1-Phase/3-Phase 100 W EtherCAT Servo Drive
ASD-A2-0221-E	A2 220 V 1-Phase/3-Phase 200 W EtherCAT Servo Drive
ASD-A2-0421-E	A2 220 V 1-Phase/3-Phase 400 W EtherCAT Servo Drive
ASD-A2-0721-E	A2 220 V 1-Phase/3-Phase 750 W EtherCAT Servo Drive
ASD-A2-1021-E	A2 220 V 1-Phase/3-Phase 1.0 kW EtherCAT Servo Drive
ASD-A2-1521-E	A2 220 V 1-Phase/3-Phase 1.5 kW EtherCAT Servo Drive
ASD-A2-2023-E	A2 220 V 3-Phase 2.0 kW EtherCAT Servo Drive
ASD-A2-3023-E	A2 220 V 3-Phase 3.0 kW EtherCAT Servo Drive

ASDA-A2-E EtherCAT Servo Drives - 400 V Series	
ASD-A2-0443-E	A2 400 V 3-Phase 400 W EtherCAT Servo Drive
ASD-A2-0743-E	A2 400 V 3-Phase 750 W EtherCAT Servo Drive
ASD-A2-1043-E	A2 400 V 3-Phase 1.0 kW EtherCAT Servo Drive
ASD-A2-1543-E	A2 400 V 3-Phase 1.5 kW EtherCAT Servo Drive
ASD-A2-2043-E	A2 400 V 3-Phase 2.0 kW EtherCAT Servo Drive
ASD-A2-3043-E	A2 400 V 3-Phase 3.0 kW EtherCAT Servo Drive
ASD-A2-4543-E	A2 400 V 3-Phase 4.5 kW EtherCAT Servo Drive
ASD-A2-5543-E	A2 400 V 3-Phase 5.5 kW EtherCAT Servo Drive
ASD-A2-7543-E	A2 400 V 3-Phase 7.5 kW EtherCAT Servo Drive

<b>ECML-S Linear Shaft Motor - Coil Assembly Model</b> (Max. Thrust: 87.12 N ~ 736 N)	
ECML-S16 □ □ A2DNS	Shaft Diameter Ø16 Coil Assembly Model
ECML-S20 □ □ A2DNS	Shaft Diameter Ø20 Coil Assembly Model
ECML-S25 □ □ A2DNS	Shaft Diameter Ø25 Coil Assembly Model
ECML-S32 □ □ A2DNS	Shaft Diameter Ø25 Coil Assembly Model

<b>ECML-SM Linear Shaft Motor - Magnetic Way Model</b> (Total Length: 250 mm ~ 2310 mm)	
ECML-SM16 □ □ □ □	Shaft Diameter Ø16 Magnetic Way Model
ECML-SM20 □ □ □ □	Shaft Diameter Ø20 Magnetic Way Model
ECML-SM25 □ □ □ □	Shaft Diameter Ø25 Magnetic Way Model
ECML-SM32 □ □ □ □	Shaft Diameter Ø32 Magnetic Way Model

**ASIA (Taiwan)**



**Taoyuan Technology Center (Green Building)**



**Taoyuan Plant 1**



**Tainan Plant (Diamond-rated Green Building)**

**ASIA (China)**



**Wujiang Plant 3**



**Delta Electronics**



**ASIA (Japan)**



Tokyo Office

**ASIA (India)**



Rudrapur Plant (Green Building)

**EUROPE**



Amsterdam, Netherlands

**AMERICA**



Research Triangle Park

▲ Factories 5 ■ Branch Offices 102 ● R&D Centers 6 ■ Distributors 824

urope

Russia

oscow

ey

Armenia

Iraq

Qatar

Saudi Arabia

UAE

Dubai

Oman

India

Chandigarh

Gurgaon

Kolkata

Ahmedabad

Mumbai

Pune

Hyderabad

Bangalore

Chennai

Coimbatore

Visakhapatnam

Jamshedpur

Thailand

Vietnam

Malaysia

Singapore

Indonesia

Philippines

China

Australia

Melbourne

New Zealand

Kyrgyzstan

Uzbekistan

Azerbaijan

**Korea**

Seoul  
Daegu

**Japan**

Tokyo  
Osaka

Japan

Shanghai

Wujiang

Taoyuan

(Technology Center & Plant 1)

Zhong Li

Taichung

Tainan

Heilongjiang

Harbin

Jilin

Changchun

Liaoning

Shenyang  
Dalian

Shanxi

Taiyuan

Beijing

Tianjin

Hebei

Shijiazhuang

Shandong

Weifang  
Qingdao  
Jinan  
Linyi

Jiangsu

Yangzhou  
Nanjing  
Nantong  
Changzhou

Wuxi  
Suzhou  
Zhangjiagang

Shanghai

Anhui

Hefei

**9 Jiangsu**

Yangzhou  
Nanjing  
Nantong  
Changzhou

Wuxi  
Suzhou  
Zhangjiagang

**10 Shanghai**

**11 Anhui**

Hefei

**12 Zhejiang**

Hangzhou  
Ningbo  
Taizhou  
Wenzhou  
Jiaxing  
Shaoxing

**13 Fujian**

Xiamen

**14 Jiangxi**

Nanchang

**15 Guangdong**

Shantou  
Dongguan  
Shenzhen  
Guangzhou  
Foshan

**16 Guangxi**

Nanning

**17 Yunnan**

Kunming

**18 Sichuan**

Chengdu

**13 Fujian**

Xiamen

**14 Jiangxi**

Nanchang

**15 Guangdong**

Shantou  
Dongguan  
Shenzhen  
Guangzhou  
Foshan

**16 Guangxi**

Nanning

**17 Yunnan**

Kunming

**18 Sichuan**

Chengdu

**19 Shaanxi**

Xian

**20 Henan**

Zhengzhou

**21 Hubei**

Wuhan

**22 Hunan**

Changsha

**23 Chongqing**



Smarter. Greener. Together.

## Industrial Automation Headquarters

### Delta Electronics, Inc.

Taoyuan Technology Center  
No.18, Xinglong Rd., Taoyuan District,  
Taoyuan City 33068, Taiwan  
TEL: 886-3-362-6301 / FAX: 886-3-371-6301

## Asia

### Delta Electronics (Shanghai) Co., Ltd.

No.182 Minyu Rd., Pudong Shanghai, P.R.C.  
Post code : 201209  
TEL: 86-21-6872-3988 / FAX: 86-21-6872-3996  
Customer Service: 400-820-9595

### Delta Electronics (Japan), Inc.

Tokyo Office  
Industrial Automation Sales Department  
2-1-14 Shibadaimon, Minato-ku  
Tokyo, Japan 105-0012  
TEL: 81-3-5733-1155 / FAX: 81-3-5733-1255

### Delta Electronics (Korea), Inc.

Seoul Office  
1511, 219, Gasan Digital 1-Ro., Geumcheon-gu,  
Seoul, 08501 South Korea  
TEL: 82-2-515-5305 / FAX: 82-2-515-5302

### Delta Energy Systems (Singapore) Pte Ltd.

4 Kaki Bukit Avenue 1, #05-04, Singapore 417939  
TEL: 65-6747-5155 / FAX: 65-6744-9228

### Delta Electronics (India) Pvt. Ltd.

Plot No.43, Sector 35, HSIIDC Gurgaon,  
PIN 122001, Haryana, India  
TEL: 91-124-4874900 / FAX : 91-124-4874945

### Delta Electronics (Thailand) PCL.

909 Soi 9, Moo 4, Bangpoo Industrial Estate (E.P.Z),  
Pattana 1 Rd., T.Phraksa, A.Muang,  
Samutprakarn 10280, Thailand  
TEL: 66-2709-2800 / FAX : 662-709-2827

### Delta Energy Systems (Australia) Pty Ltd.

Unit 20-21/45 Normanby Rd., Notting Hill Vic 3168, Australia  
TEL: 61-3-9543-3720

## Americas

### Delta Electronics (Americas) Ltd.

Raleigh Office  
P.O. Box 12173, 5101 Davis Drive,  
Research Triangle Park, NC 27709, U.S.A.  
TEL: 1-919-767-3813 / FAX: 1-919-767-3969

### Delta Greentech (Brasil) S/A

São Paulo Office  
Rua Itapeva, 26 – 3º Andar - Bela Vista  
CEP: 01332-000 – São Paulo – SP - Brasil  
TEL: 55-11-3530-8642 / 55-11-3530-8640

### Delta Electronics International Mexico S.A. de C.V.

Mexico Office  
Vía Dr. Gustavo Baz No. 2160, Colonia La Loma,  
54060 Tlalnepanitla Estado de Mexico  
TEL: 52-55-2628-3015 #3050/3052

## EMEA

### Headquarters: Delta Electronics (Netherlands) B.V.

Sales: Sales.IA.EMEA@deltaww.com  
Marketing: Marketing.IA.EMEA@deltaww.com  
Technical Support: iatechnicalsupport@deltaww.com  
Customer Support: Customer-Support@deltaww.com  
Service: Service.IA.emea@deltaww.com  
TEL: +31(0)40 800 3800

### BENELUX: Delta Electronics (Netherlands) B.V.

De Witbogt 20, 5652 AG Eindhoven, The Netherlands  
Mail: Sales.IA.Benelux@deltaww.com  
TEL: +31(0)40 800 3800

### DACH: Delta Electronics (Netherlands) B.V.

Coesterweg 45, D-59494 Soest, Germany  
Mail: Sales.IA.DACH@deltaww.com  
TEL: +49(0)2921 987 0

### France: Delta Electronics (France) S.A.

ZI du bois Challand 2, 15 rue des Pyrénées,  
Lisses, 91090 Evry Cedex, France  
Mail: Sales.IA.FR@deltaww.com  
TEL: +33(0)1 69 77 82 60

### Iberia: Delta Electronics Solutions (Spain) S.L.U

Ctra. De Villaverde a Vallecas, 265 1º Dcha Ed.  
Hormigueras – P.I. de Vallecas 28031 Madrid  
TEL: +34(0)91 223 74 20

Carrer Llacuna 166, 08018 Barcelona, Spain

Mail: Sales.IA.Iberia@deltaww.com

### Italy: Delta Electronics (Italy) S.r.l.

Ufficio di Milano Via Senigallia 18/2 20161 Milano (MI)  
Piazza Grazioli 18 00186 Roma Italy  
Mail: Sales.IA.Italy@deltaww.com  
TEL: +39 02 64672538

### Russia: Delta Energy System LLC

Vereyskaya Plaza II, office 112 Vereyskaya str.  
17 121357 Moscow Russia  
Mail: Sales.IA.RU@deltaww.com  
TEL: +7 495 644 3240

### Turkey: Delta Greentech Elektronik San. Ltd. Sti. (Turkey)

Şerifaii Mah. Hendem Cad. Kule Sok. No:16-A  
34775 Ümraniye – İstanbul  
Mail: Sales.IA.Turkey@deltaww.com  
TEL: + 90 216 499 9910

### GCC: Delta Energy Systems AG (Dubai BR)

P.O. Box 185668, Gate 7, 3rd Floor, Hamarain Centre  
Dubai, United Arab Emirates  
Mail: Sales.IA.MEA@deltaww.com  
TEL: +971(0)4 2690148

### Egypt + North Africa: Delta Electronics

511 Cairo Business Plaza, North 90 street,  
New Cairo, Cairo, Egypt  
Mail: Sales.IA.MEA@deltaww.com