



Automation for a Changing World

# Delta PC-Based Motion Controller PAC Total Solution

[www.deltaww.com](http://www.deltaww.com)

 **DELTA**  
Smarter. Greener. Together.



**Reliable, Flexible, and Highly Integrated**

## **A Perfect PAC Platform to Meet Your Needs and Challenges**

Delta's PAC platform is a solution with high reliability, integrated network communication capability, and high-end motion control functions, and is ideal for advanced automation machining. Through EtherCAT or DMCNET communication, the platform is able to perform high-response, high-precision, and synchronous multi-axis motion control with easy and flexible operation.

Its cable-less and fan-less design enhances reliability and resistance for harsh environments and contaminants. It is also implemented with an X86 dual-core processor and EtherCAT or DMCNET communication that enables faster and more convenient data transmission.

With the built-in dynamic-link library (DLL), the controller of the platform effectively simplifies the implementation process and saves development time. In addition, the integrated versatile software of the platform provides a perfect integration of logic programming control (with SoftPLC), human machine interface (with SoftHMI), numeric control and robot control, supporting IEC61131-3 programming languages and high performance motion control for a wide range of applications and industries.

Delta's PAC platform offers a comprehensive, highly integrated, and easy industrial PC-based motion control solution to help optimize customers' competitiveness with capabilities for getting ahead of the game.



## Table of Contents

1	Introduction
3	Product Features
4	System Structure
	- PAC under DMCNET Structure
	- PAC under EtherCAT Structure
	- CODESYS RTE
9	Soft Numeric Control (SNC)
14	IPC Motion Platform (IMP)
17	Fieldbus Verification and Validation
	- EzDMC Software
	- EcNavi Software
21	Specifications of PACs
	- MH1 Series
	- MH2 Series
	- MP1-A10D Series
	- MP1-P10D-15 Series
27	DMCNET Remote Modules (DMCNET Slaves)
43	EtherCAT Remote Modules (EtherCAT Slaves)

## Product Features

### Energy Efficient and Robust Hardware

- The MH1 Series: provides a cable-less, fan-less and low-power consumption design, increasing reliability and providing CFast card and SSD slots inside for fast and stable data transmission
- The MP1 Series: equipped with a 10.1-inch touchscreen for more flexible operation



**MH1 Series**

### CODESYS-enabled **New**

The CODESYS-enabled MH2 Series saves development time and cost (Available in 2019 Q3)

### Multiple Peripheral Interfaces for Communication

Equipped with USB ports, serial COM ports, Gbps Ethernet ports and PCI/PCle extension slots, the MH1/MP1 Series supports CFast card, SD card, SSD, and M.2 SSD storage for quick and stable data transmission and flexible usage



**MH2 Series**

### Supports EtherCAT and DMCNET Master and Slave Modules

- Up to 12 units of DMCNET modules and 12 axes of servo motion control
- Up to 100 units of EtherCAT modules and 64 axes of servo motion control
- Multiple I/O extensions and more axes of motion control: the PCI-DMC-B01 and PCI-L221-B1



**MP1 Series**

### High Security

Each PAC provides an IC device for programming security and development protection













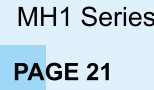





### Flexible Operation Interface with Multiple Software Programs

Supports Real Time OS (RTE, VxWorks) and General Windows 7/10\*; built-in DLL and development modules (IMP, CODESYS) to connect with SoftHMI and SoftPLC for single or multi-axis motion control. It can also integrate equipment IoT or image recognition functions for customized requirements

\*When changing to this environment, please contact customer service

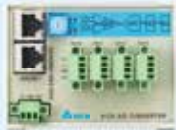

# DMCNET System Structure

Motion Controllers	 <p>PC-based Controller</p>	 <p>MH1 Series <b>PAGE 21</b></p>	 <p>MP1 Series <b>PAGE 25</b></p>			
Servo Systems	 <p>Servo Motors and Drives</p> <p>ASDA-A3-F <b>PAGE 33</b></p>	 <p>ASDA-A2-F <b>PAGE 35</b></p>	 <p>ASDA-B2-F <b>PAGE 37</b></p>	 <p>ASDA-M <b>PAGE 39</b></p>		
Digital Remote Modules	 <p>32 Digital Input Remote Module ASD-DMC-RM32MN</p>	 <p>64 Digital Input Remote Module ASD-DMC-RM64MN</p>	 <p>Digital I/O Remote Module HMC-RIO3232RT5</p>	 <p>32 Digital Output Remote Module ASD-DMC-RM32NT</p>	 <p>64 Digital Output Remote Module ASD-DMC-RM64NT</p>	 <p>32 Digital I/O Remote Module ASD-DMC-RM32PT <b>PAGE 27 ~ 28</b></p>
Pulse Remote Module	 <p>4-Channel Pulse Remote Module ASD-DMC-RM04PI <b>PAGE 29</b></p>					
Analog Remote Modules	 <p>4-Channel Analog Output Remote Module ASD-DMC-RM04DA</p>	 <p>4-Channel Analog Input Remote Module ASD-DMC-RM04AD <b>PAGE 30</b></p>				
Gateway Type Remote Modules	 <p>Gateway Type Remote Power Coupler ASD-DMC-GA01</p>	 <p>Gateway Type 1-Channel Pulse Remote Module ASD-DMC-GE01PH <b>PAGE 32</b></p>				

# Delta's High-Speed Motion Control System - DMCNET

Delta's Motion Control NETWORK (DMCNET) is a high speed, real-time communication system, capable of controlling up to 12 axes of servo system units within 1ms simultaneously: with 3-axis helical and linear interpolation in 4 groups, or 2-axis linear and arc interpolation in 6 groups. It supports 64-bit dual-precision floating point, allowing high-precision system calculations and flexible operation, and also absolute commands, incremental commands and T-curve / S-curve velocity profiles for different uses. With built-in position, speed and torque control modes, and 35 homing modes, it is able to receive real-time servo information, parameters, or change control modes via communication command, offering fast communication and motion control for various applications

## DMCNET Motion Control Structure

In addition to a one-wire communication protocol, the DMCNET also provides various options, such as 6-axis PCI-DMC-F02, 12-axis PCI-DMC-A02, and the PCI-DMC-B01 with pulse compare & capture functions. Based on user's requirements, the servo drive can be combined with Servo Motor ASDA-A3-F Series, ASDA-A2-F Series, ASDA-B2-F Series or Linear Motor A2R Series. Delta provides users achieve best product performance and value with minimum investment

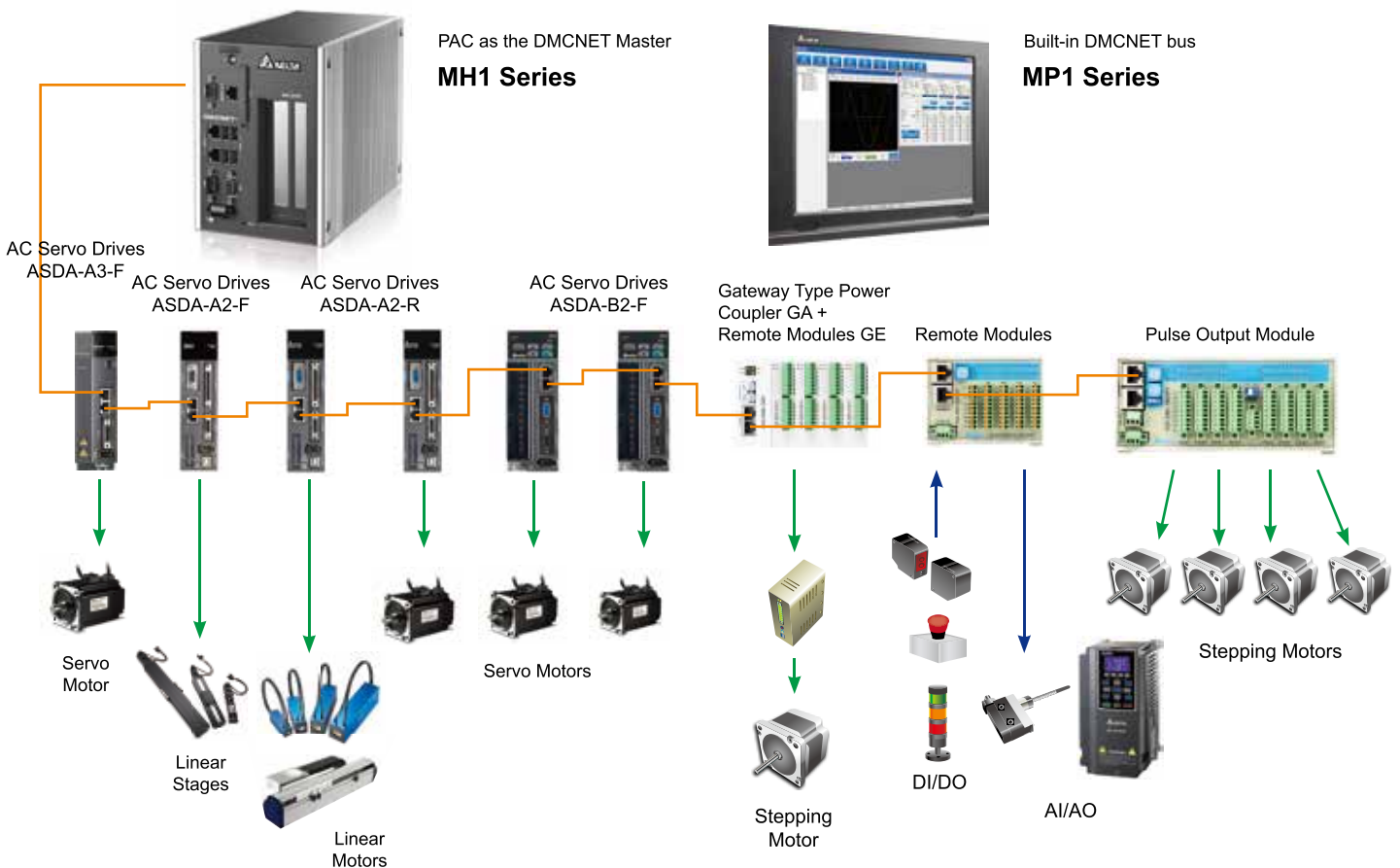

# EtherCAT System Structure

## Motion Controllers

PC-based controller



MH2 Series

PAGE 23

## Servo Systems

AC Servo Drive



ASDA-A2-E

PAGE 48

## Gateway Type Remote Modules

Gateway Type E-Bus Remote Power Coupler



R1-EC5500D0 R1-EC5512D0

PAGE 43

## Pulse Remote Module



1-Channel Pulse Remote Module

R1-EC5621D0

PAGE 44

## Digital Remote Modules

16 Digital Input Remote Module

R1-EC6002D0  
R1-EC6022D0



16 Digital Input Remote Module

R1-EC7062D0  
R1-EC70A2D0  
R1-EC70E2D0  
R1-EC70F2D0

PAGE 45~46

## Analog Remote Modules

4-Channel Analog Output Remote Module

R1-EC8124D0



4-Channel Analog Output Remote Module

R1-EC9144D0

PAGE 47~48

## Functional Remote Modules

For Manual Pulse Generator (MPG)

R1-EC5614D0



PAGE 49

# High-Speed Motion Control System - EtherCAT

Ethernet Central Automation Technology (EtherCAT) is an open Ethernet-based fieldbus system that provides high-efficiency and high-performance synchronization quality for automation control.

## EtherCAT Motion Control Structure

With EtherCAT, Delta's EtherCAT motion control card PCI-L221-P1 achieves rapid and real-time multiple axes of motion control, and is capable of controlling up to 100 slave stations that enable a 64-axis motion control within 1ms cycle time. It also provides 35 homing modes, point-to-point position control, 2-axis interpolation, 3-axis interpolation, multi-axis synchronization, continuous motion, gantry control, speed control, torque control and more. In addition, the IEC61131 is also one of the optional functions for programming flexibility and scalability.

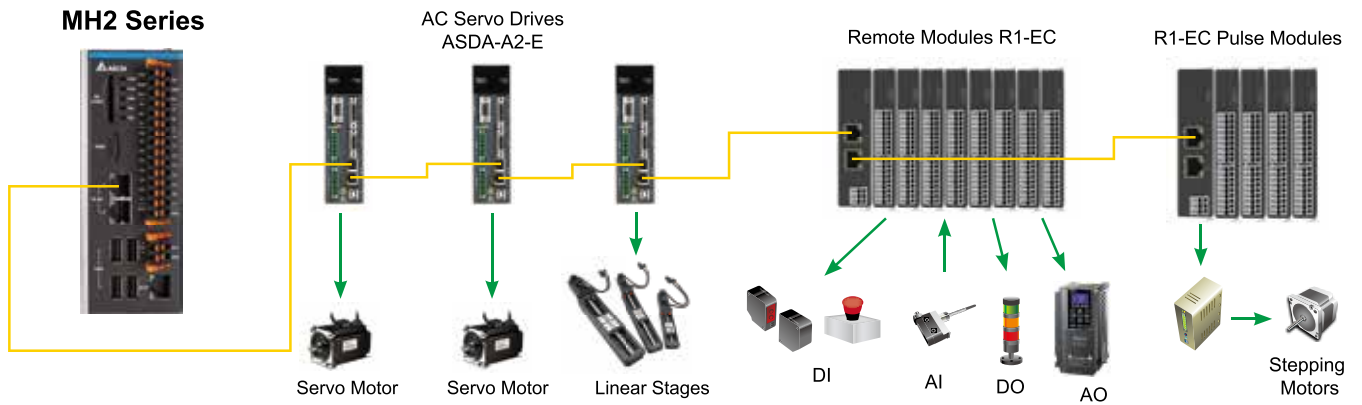

## EtherCAT Motion Control Structure

For EtherCAT rapid and high performance communication, Delta provides a rugged and high-speed motion control solution with complete functions for EtherCAT masters, and that supports device description in XML format (EtherCAT Slave Information - ESI) that are useful for EtherCAT device development. Delta's EtherCAT motion control solution also allows the system to quickly identify ESI files and offers the capability of real-time connection via EtherCAT for high-level integration. Its rapid communication can update commands between stations within 1ms to ensure accurate and prompt data transfer within the network.

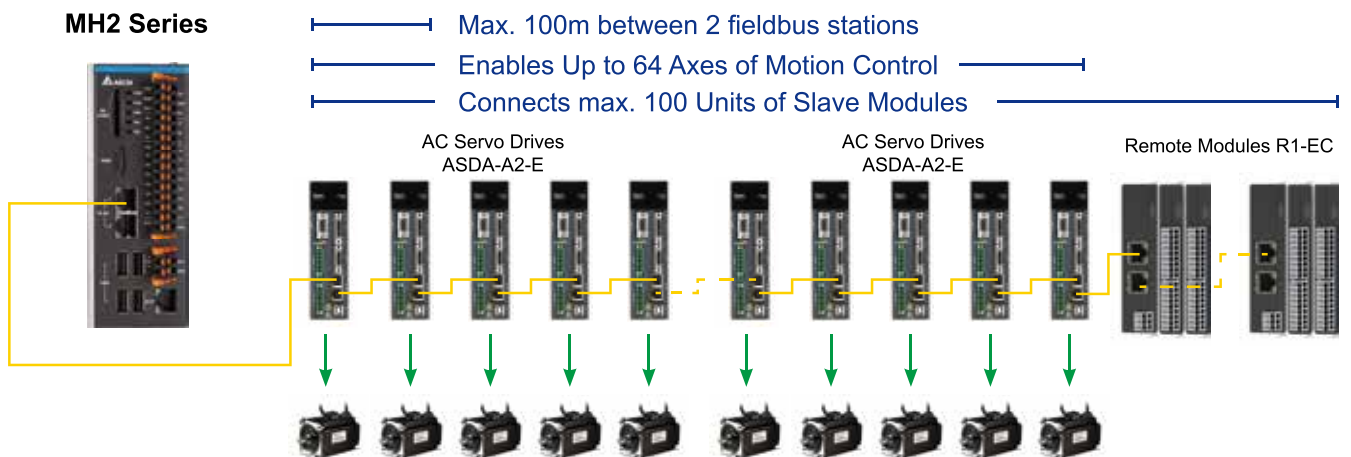



# CODESYS RTE

Integrated editing interface based on CODESYS, supporting connection with SoftPLC, HMI and EtherCAT bus system and related equipment

## Features

- Standard PLCOpen motion control function
- 1ms synchronous cycle, supports total 64 real and virtual axes
- E-CAM contouring function and graphical CAM curve editing
- Supports 65,535 points in one CAM

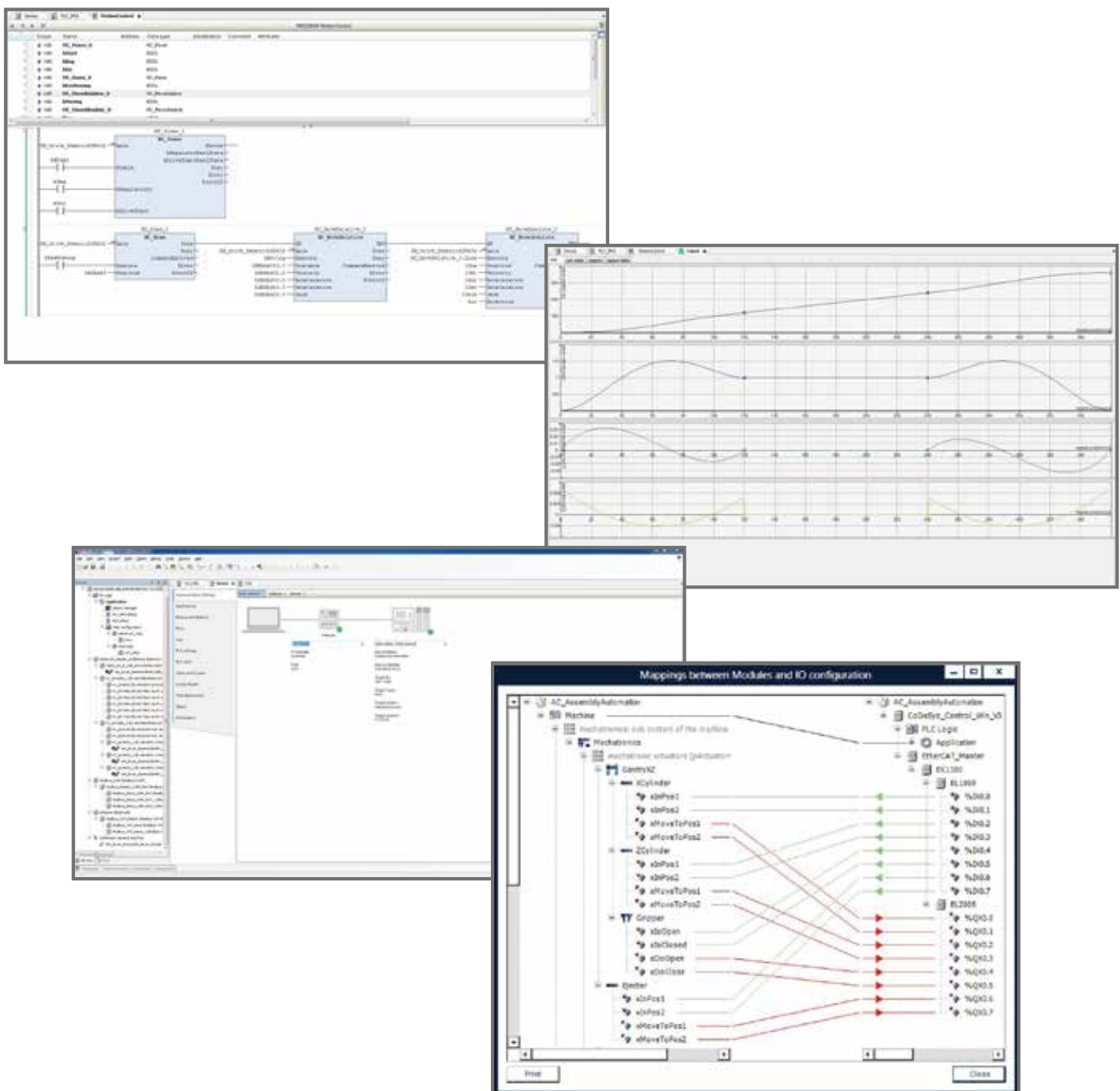

# Soft Numeric Control (SNC)

## SNC Software Structure with DMCNET

MH1-XXD Series



MP1 Series

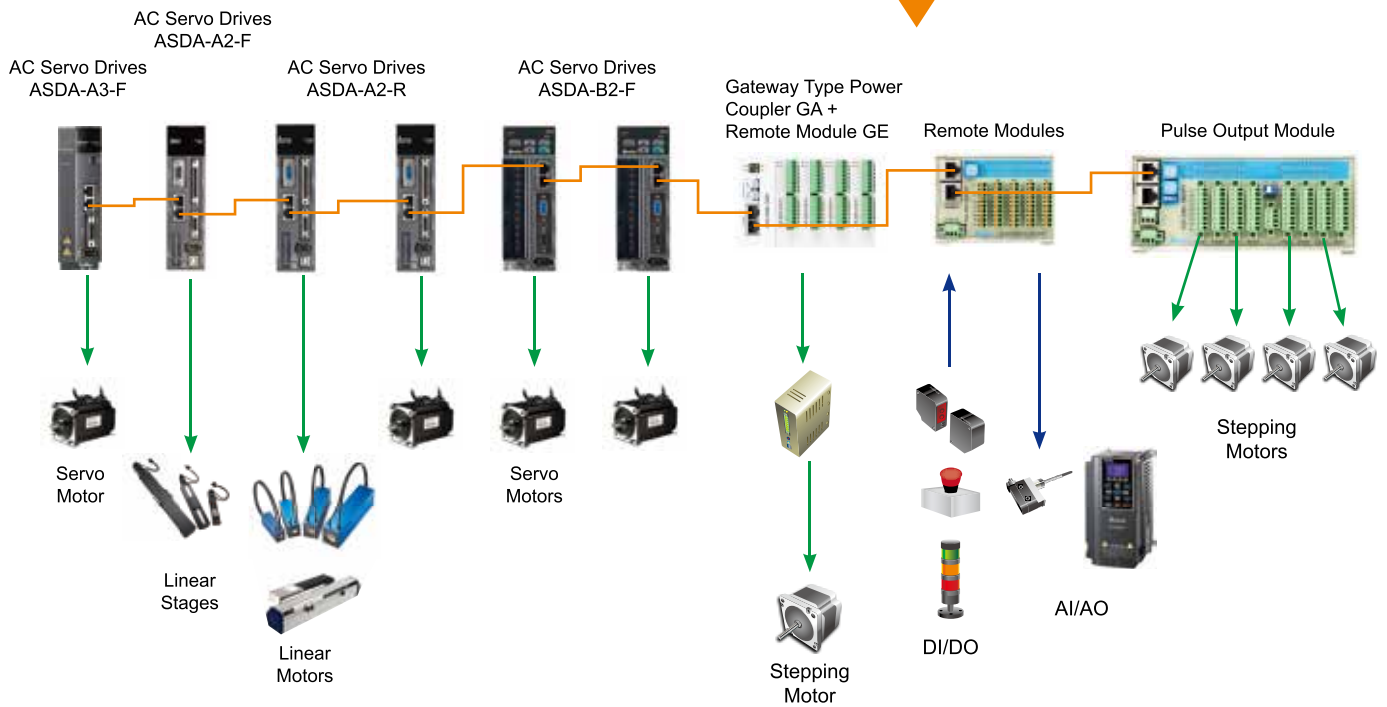
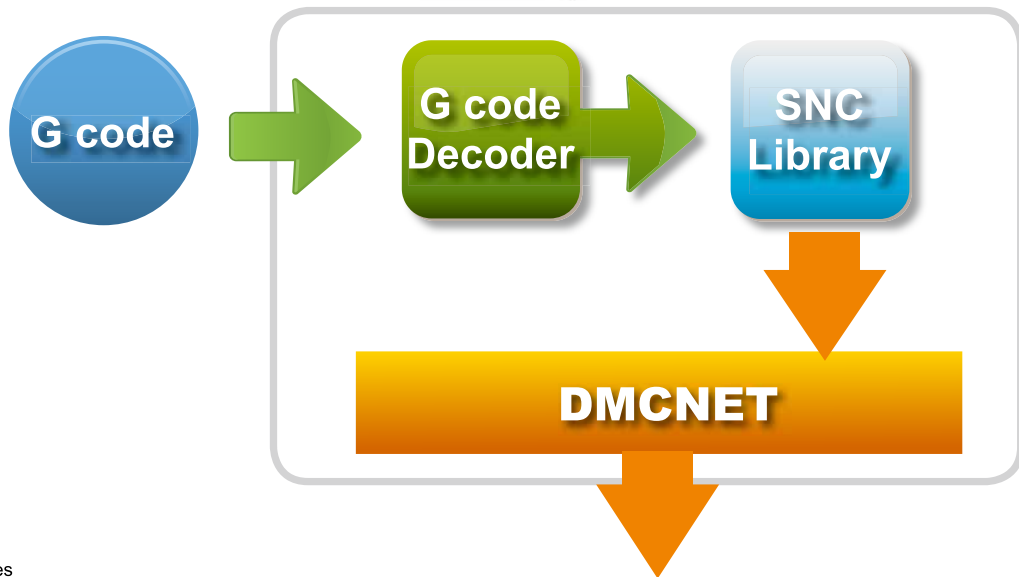
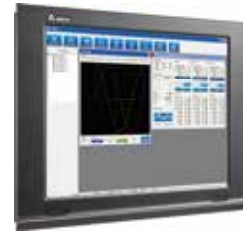

# Soft Numeric Control (SNC)

## SNC Software Structure with EtherCAT

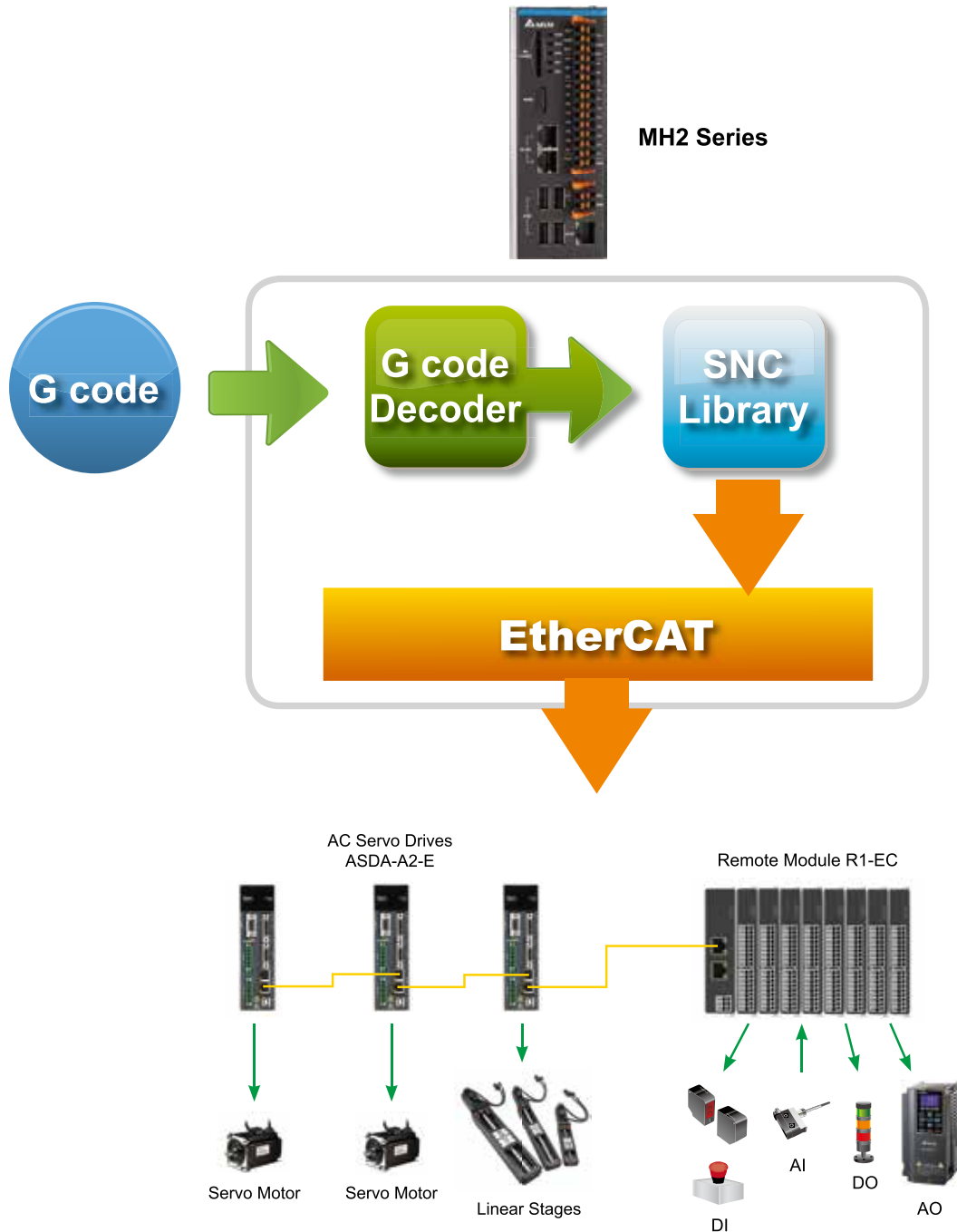

# SNC Features

## SNC Library

The SNC Library offers abundant DLLs, including built-in G code decoder, Jerk control, S-curve smoothing, automatic corner deceleration, high speed multi-block look-ahead, curve fitting, tool management and other functions. It helps users develop user-defined NC programs through platforms such as BCB, C#, Delphi, VB, VB.Net, and VC.

## G code Decoder

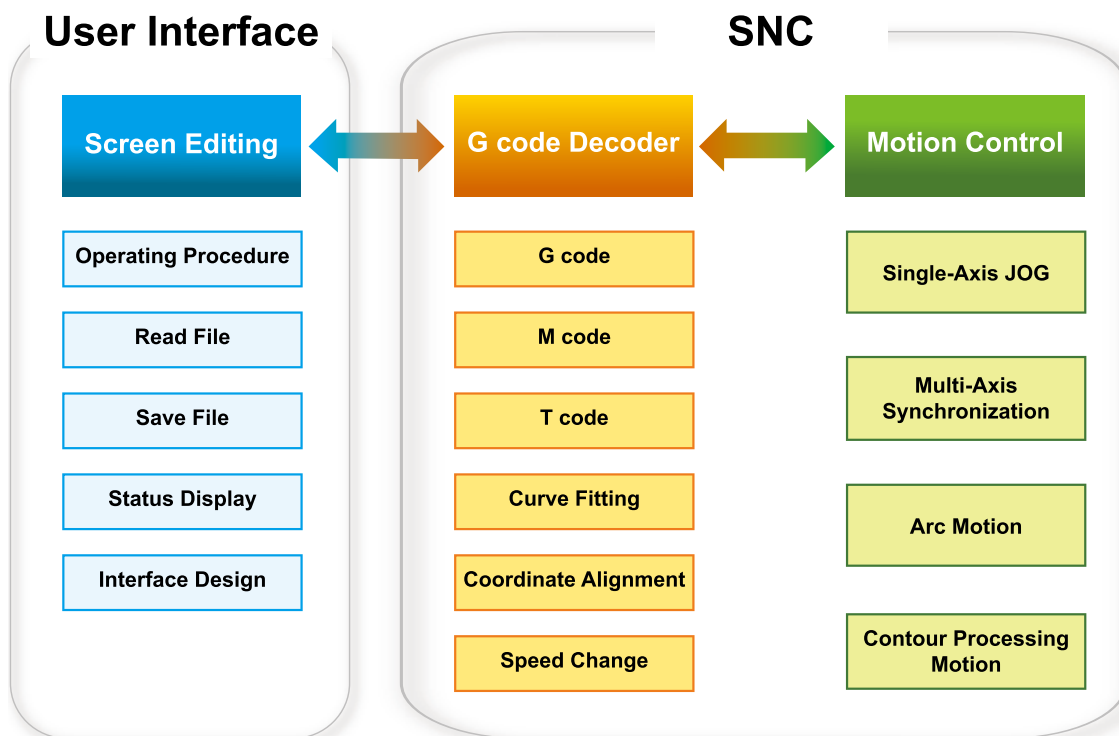

## Jerk Control

- When acceleration changes significantly, or the cutting path changes from a straight line to curve, the Jerk Control decelerates speed to suppress machine vibration and shock and to maintain stability and precision for long term operation.

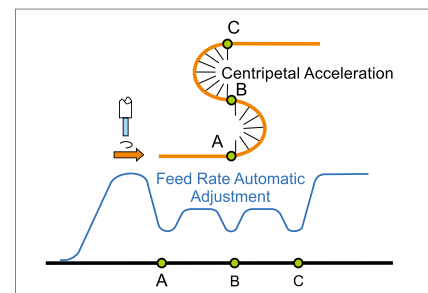

## S-Curve Smoothing

- The S-curve acceleration profile for smooth acceleration and deceleration before interpolation minimizes vibration and offers a stable and high-precision machining process.

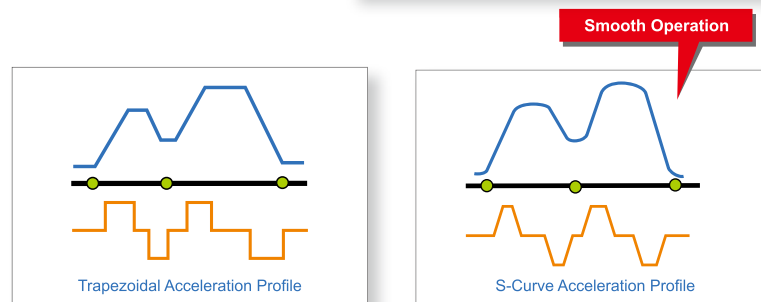

## Automatic Corner Deceleration

- During machining processes, corner deceleration is automatically calculated to help each axis maintain its precision and speed at corners and effectively smooth the process.

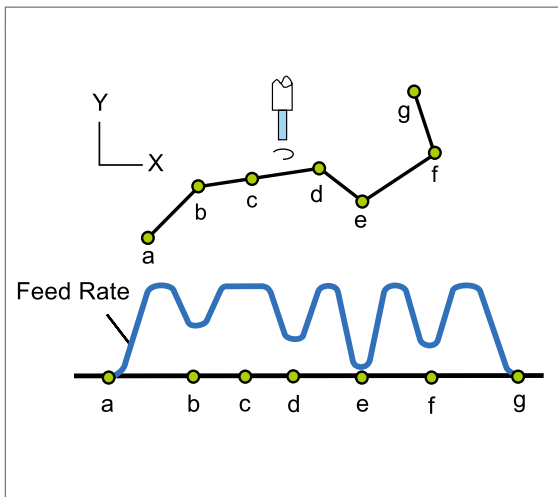

## Friction Compensation

- The servo drives provide real-time and smooth friction compensation with high sampling speed control loop for correcting the torque.

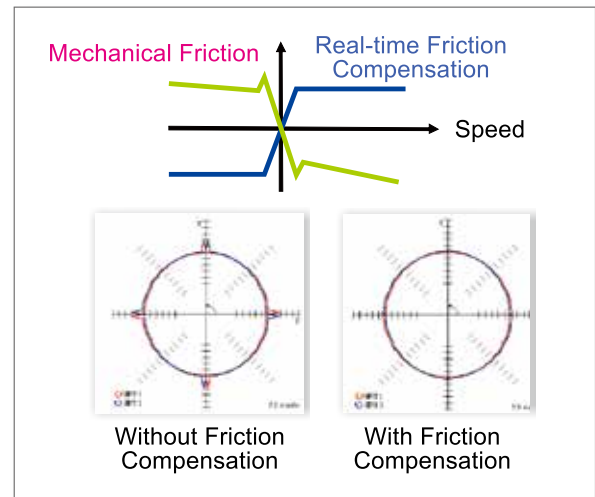

## Look-Ahead

- The look-ahead function performs processing operations according to the preset feed rate and path. This can efficiently reduce unnecessary deceleration and effectively increase production speed.

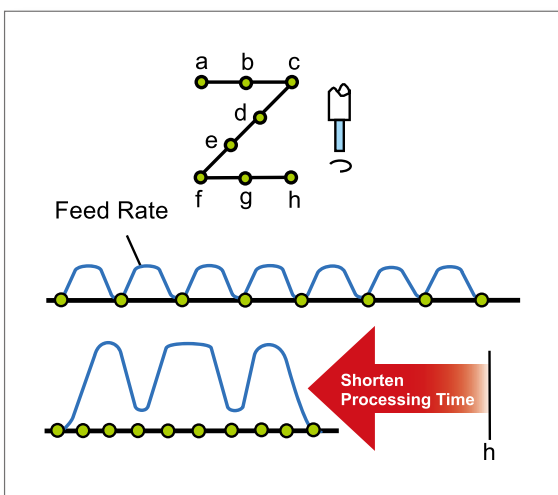

## Curve Fitting

- The curve fitting function smooths the motion of the processing axis to avoid a noncontinuous turn speed, and enhances the precision and speed of the processing operation, while the processing can be evenly applied.

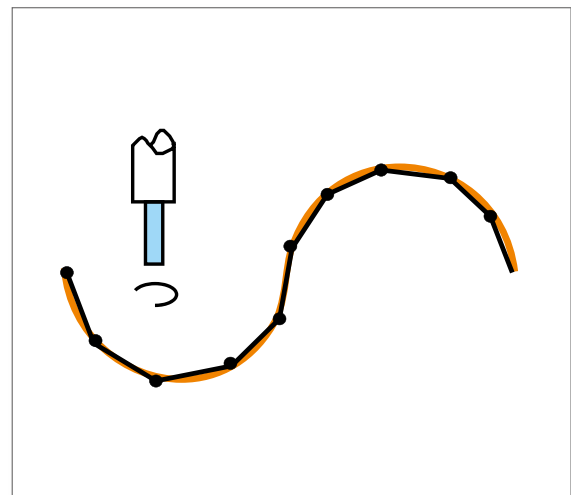

# SNC Features

## Execute Specific Line Number

- When the machining is stopped by an incident, users can restart their program at a specified G-Code line number with breakpoint line number information to enhance processing efficiency.

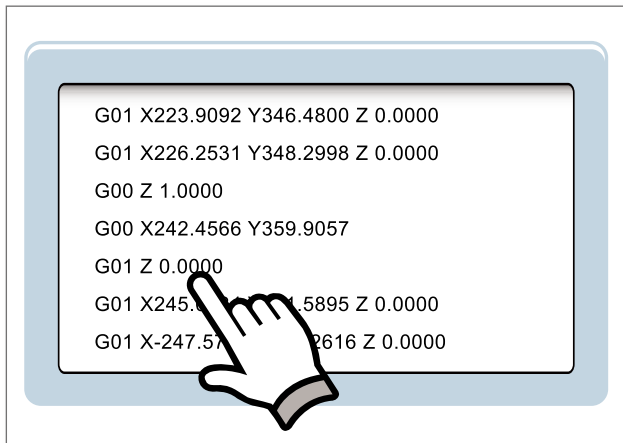

## Back and Release

- If there is a sudden stop due to incomplete workpieces cuts or insufficient oxy-fuel gas during laser and flame cutting, this function helps the tool move back to the intermediate point of the original processing path and continue processing.

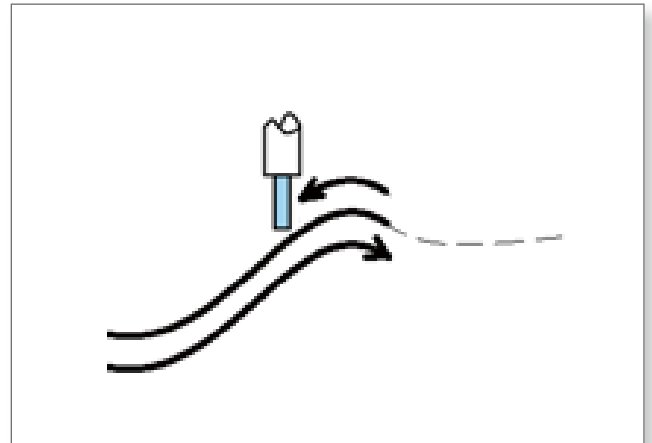

## Tool Management Function

- The tool management function provides functions such as setting tool numbers, resetting tool indexes, locking the desired tools, and setting numbers of the required cutters to prevent repeated usage and selecting the incorrect tool. The built-in carousel and armless modules also help speed up tool function setup.

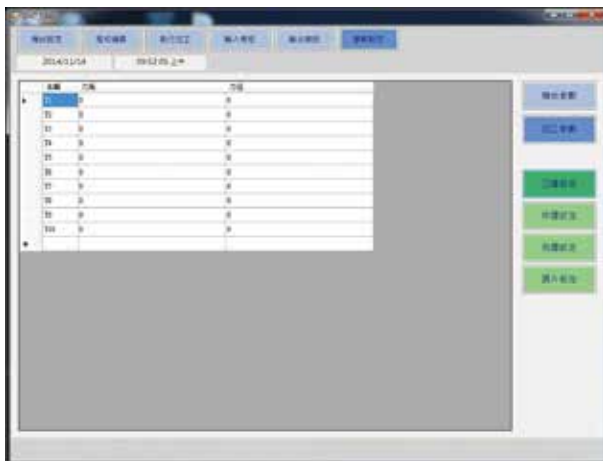

## Manual Pulse Generator (MPG) Simulation

- For first time CNC machining, the MPG simulation function can perform an exact simulation of the desired machining process under all operating conditions. It guarantees processing stability and eliminates problems with execution error or cutter/tool crashing while making processing safer and more accurate.

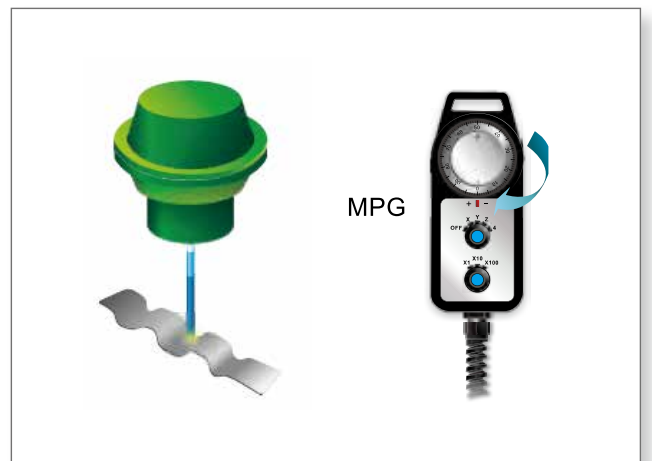

# IPC Motion Platform (IMP 1.5)

## A Simple and Fast Setup Development Platform for Realizing Unsurpassed Motion Control

The IMP is a high-speed, flexible and scalable development platform which combines powerful motion control functions and integrates Delta's HMI editing and PLC logic programming software tools to achieve complex and precise motion control based on customers' requirements.

- ▶ **Powerful Motion Control Core:** Upgrades Delta's PAC and PC with a motion control card installed to become an advanced motion controller, which integrates functions of motion control, HMI, PLC and high-speed communication fieldbus in one unit.
- ▶ **Customized Platform for Secondary Development:** Combines with Delta's standard HMI editor DOPSoft and PLC editor WPLSoft in one customer-driven platform, the platform makes complex programming and development easy and time-saving without depending on technical support from the manufacturer.
- ▶ **Scalable Communication for Expandable Network:** Through PCI extension slots, three DMCNET communication networks with up to 36 stations can be established, which means 36 axes of servo motors can be controlled simultaneously without connecting to any remote modules.
- ▶ **Industry-Oriented Controller:** Soft Numeric Control (SNC) and Motion Program Macro (MPM) are provided for users to adjust and modify self-developed motion paths and commands according to changing application requirements.
- ▶ **Standard Communication Interfaces:** Supports built-in standard MODBUS and MODBUS TCP gateways to enable data transmission and exchange between machines more conveniently.

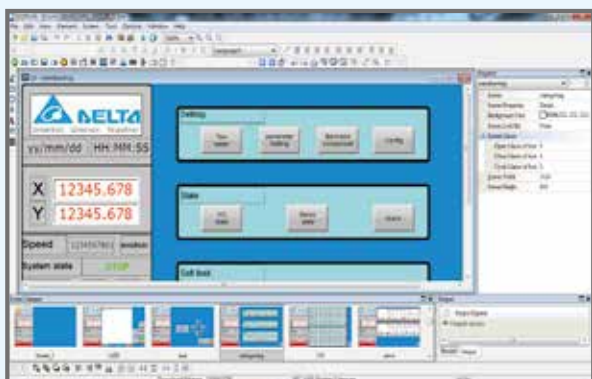

**HMI Editor**

After installing on a PC, even without C or C++ programming language, the HMI Editor DOPSoft 3.0 provides a simple path and quick downloading of customized user interfaces to Delta's PAC with the IMP for easy programming and system design. For specific industry applications, such as numerical control (NC), the IMP contains numerous example programs to provide a practical aid in real time for machine verification and evaluation.

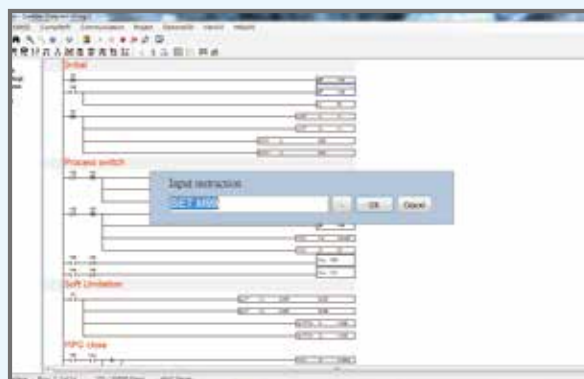

**PLC Editor**

The IMP integrates Delta's PLC editor WPLSoft that offers users a ladder diagram editing environment to develop PLC programs for secondary development and to customize their applications. The PLC editor also accepts motion control commands and allows users to control servo systems and remote I/O modules to complete single-axis motions, multi-axis linear interpolation, arc interpolation, continuous speed and other motions, fulfilling the needs of users who are familiar with the PLC.

## IMP System Configuration with DMCNET



VGA Display

### IMP - Powerful Motion Control Kernel

The IMP is the kernel of the system, like the firmware of a motion controller, which runs on one of the processors of a multi-core PC or PAC with a plug-in motion control card. Without adding extra hardware, users can download HMI screens and PLC programs, edit user-defined graphical interfaces and execute programming logic control to run machine applications via software and VGA display only.

The IMP is a powerful motion control kernel and it simplifies connectivity and delivers more flexible functionality for the entire system. Not only is MODBUS communication equipped as standard, Soft Numeric Control (SNC) and Motion Program Macro (MPM) are also provided for users to change and calibrate motion paths and commands for different application requirements.

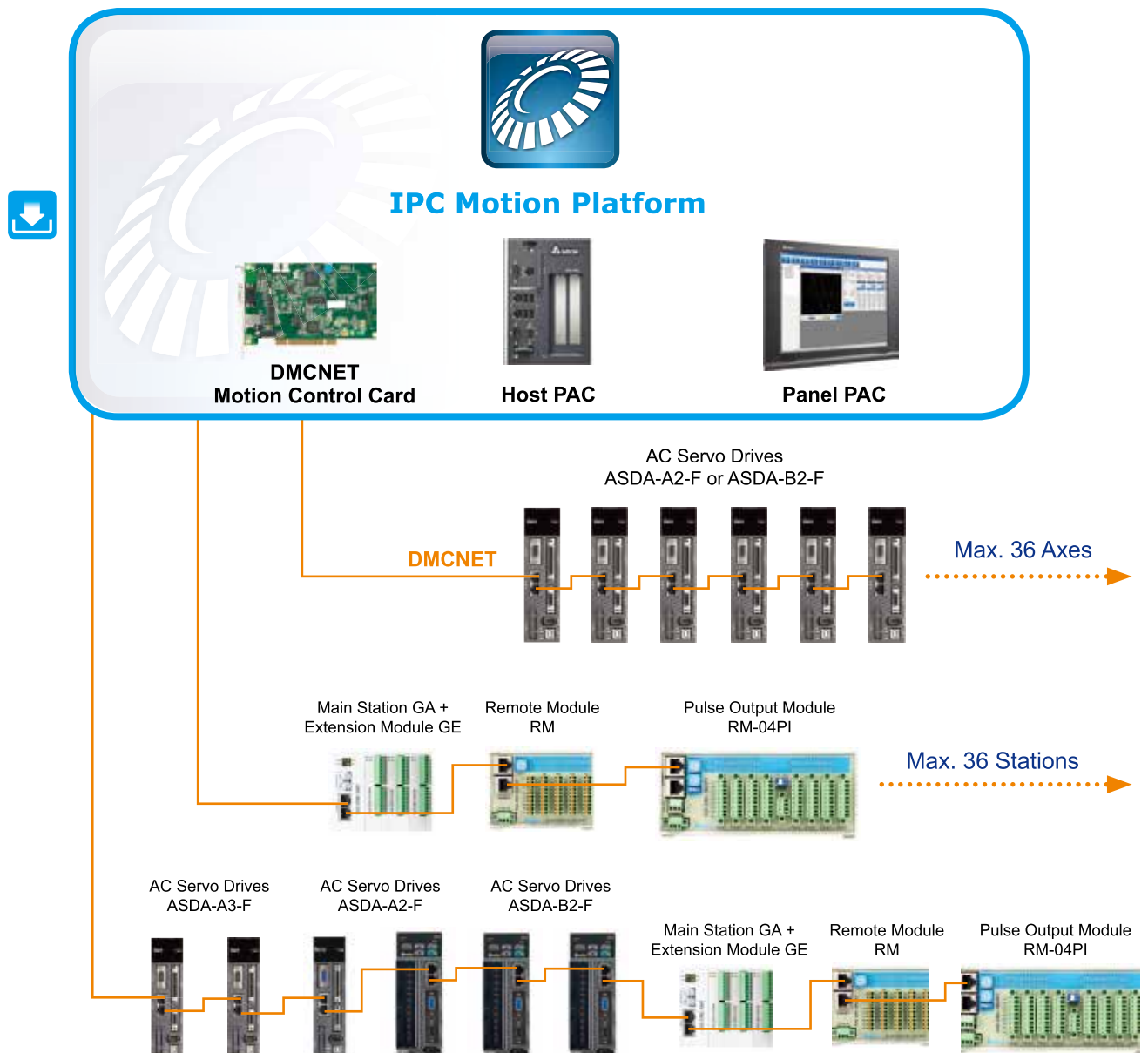



## IMP System Configuration with EtherCAT



VGA Display

### IMP - Powerful Motion Control Kernel

The IMP is the kernel of the system, like the firmware of a motion controller, which runs on one of the processors of a multi-core PC or PAC with a plug-in motion control card. Without adding extra hardware, users can download HMI screens and PLC programs, edit user-defined graphical interfaces and execute programming logic control to run machine applications via software and VGA display only.

The IMP is a powerful motion control kernel and it simplifies connectivity and delivers more flexible functionality for the entire system. Not only is MODBUS communication equipped as standard, Soft Numeric Control (SNC) and Motion Program Macro (MPM) are also provided for users to change and calibrate motion paths and commands for different application requirements.

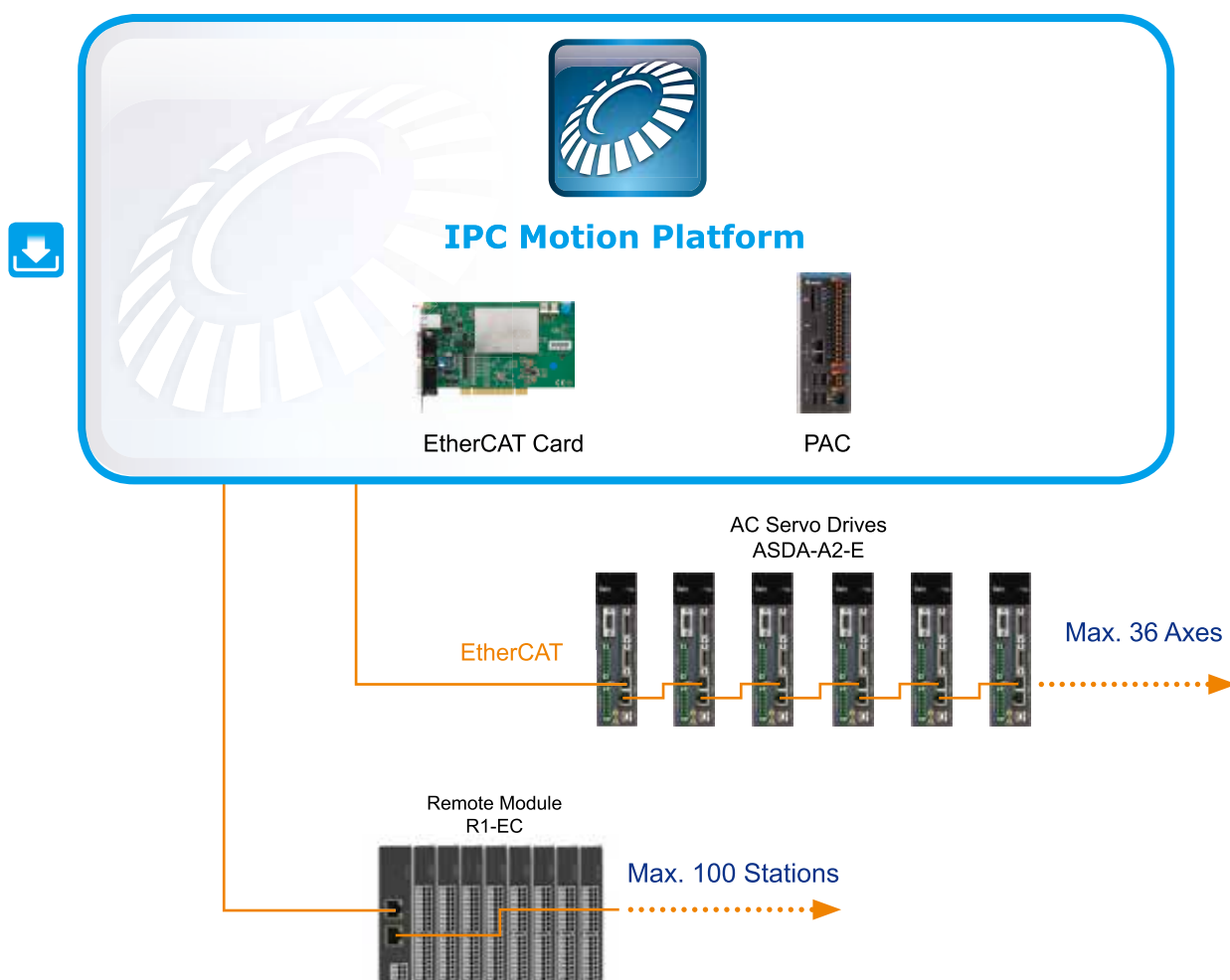

# Fieldbus Verification and Validation - EzDMC Software

EzDMC Software provides simple editing functions for all the relevant parameters of the fieldbus communication and facilitates program development and the hardware system to be easily configurable, even first time users of Delta's DMCNET motion control cards can utilize the motion control card functions.

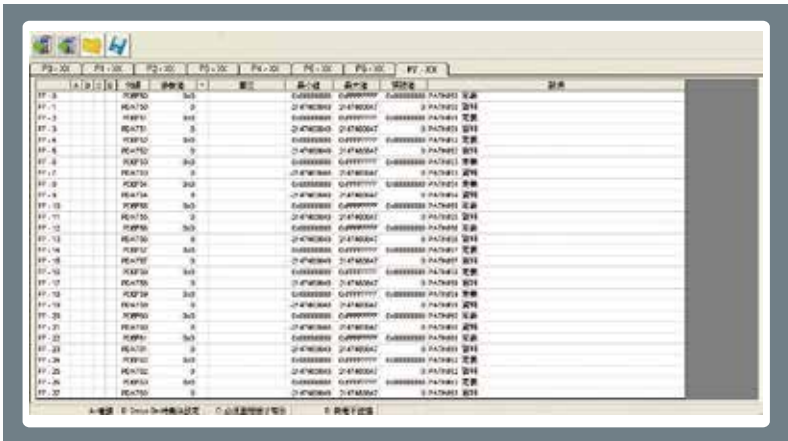

## ► User-Friendly Operation Interface

Helps users create and edit programs with clear images, easy-to-use parameter settings, and instruction disk for programming samples and function keys explanation

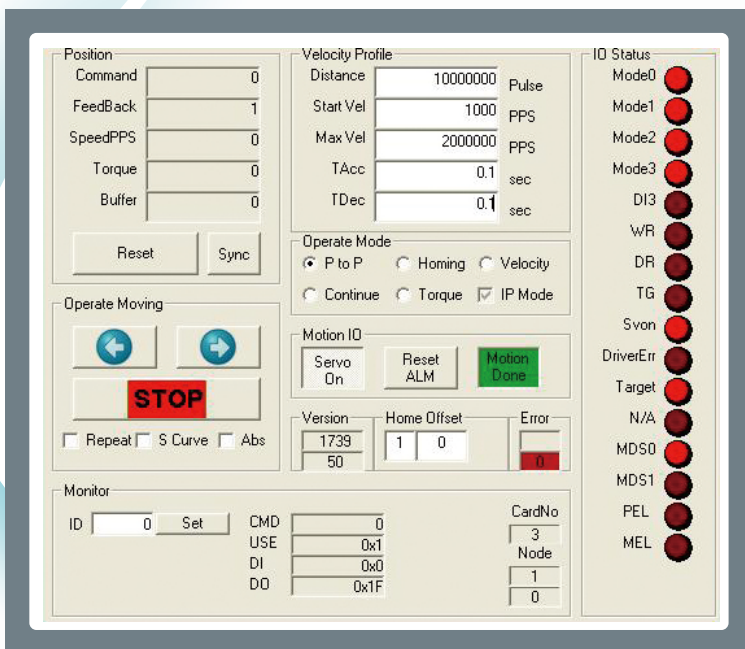

## ► Independent Control Unit

With the independent control unit, users can set up simple motions of the servo drives for flexible operation and management

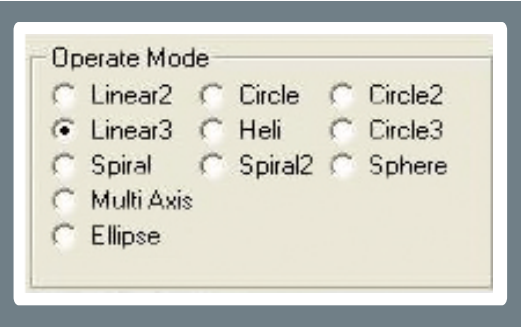

► **Multi-Axis Motion Control Modes**

Offers a variety of sample programs and control modes (e.g. Linear 2, Linear 3, Heli, Circle, Circle 2 and Circle 3) for linear, arc and helical interpolation to supervise various multi-axis motions and execute programming for multi-axis motion control applications

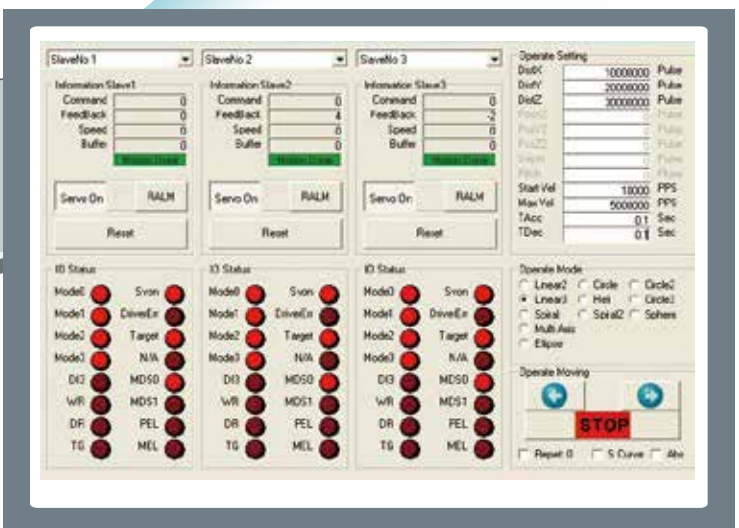
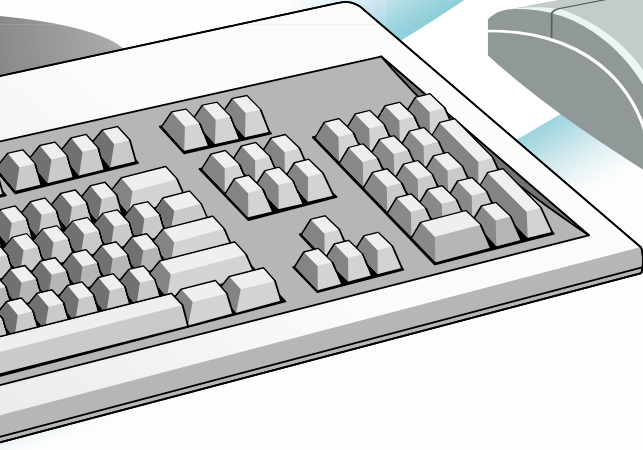

► **Real Time Response and Feedback**

Monitoring and displaying the status of the connected servo drives is completed in a timely and efficient manner

# Fieldbus Verification and Validation - EcNavi Software

## ► EtherCAT Automation Software

EcNavi development software is for configuring an EtherCAT network that includes an EtherCAT master controller and slave devices for data communication, functional identification, programming and debugging. For new users of Delta's EtherCAT motion control, the EcNavi helps them become familiar with the configuration of the system and to complete the function verification and validation in real time.



## ► Hardware Structure Search

Provides search function for all slaves connected by EtherCAT to check hardware configuration and verify whether the network communication is established successfully via software

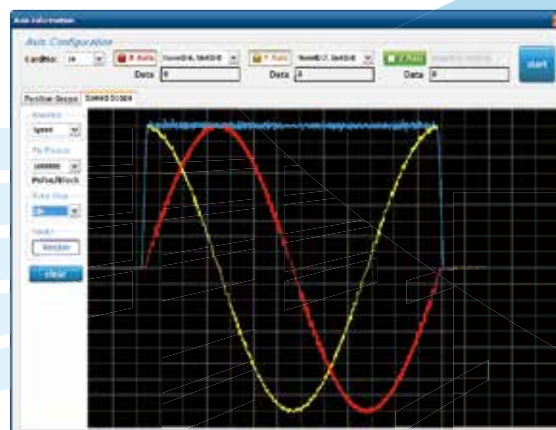

## ► Speed Curve Tracing

Offers real-time tracing for speed curves of current motion commands to achieve better synchronization effects between multiple axes

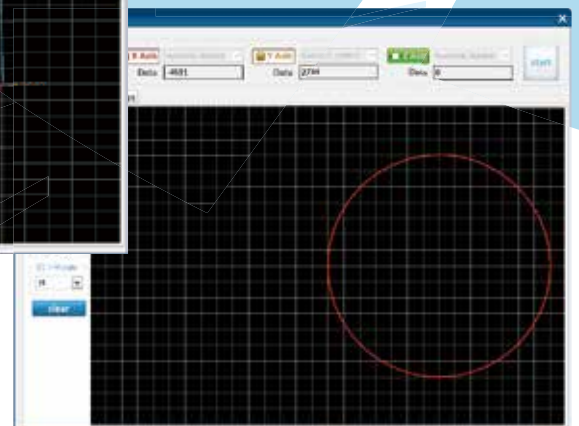



### ► Independent Control Unit

Assists users avoid writing complex programs and immediately verifies all motion commands with the servo drives to meet application requirements



### ► Multi-Axis Motion Control Mode

Offers a variety of sample programs and control modes for EtherCAT devices (e.g. Linear 2, Linear 3, Heli, Circle, Circle 2 and Circle 3) to help users easily edit and complete development programs for multi-axis motion control applications

# Dimensions

## MH1 Series

Dimensions: 230mm (L) x 127mm (W) x 175mm (H)

Frame Dimensions: 230mm (L) x 127mm (W) x 175mm (H)

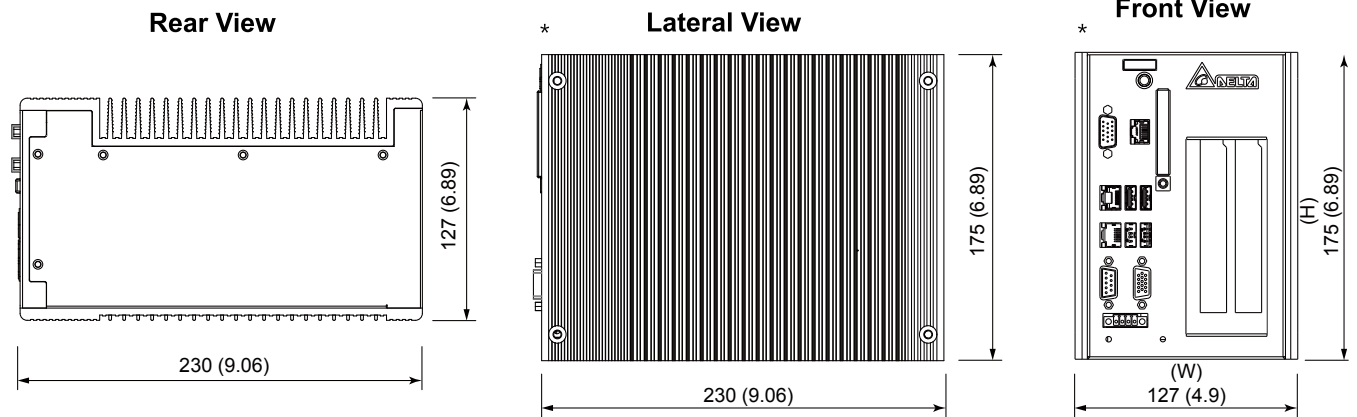

Note: All models of the MH1 Series have the same dimensions

## Exterior Description

MH1-A12/C50/C70 D Series

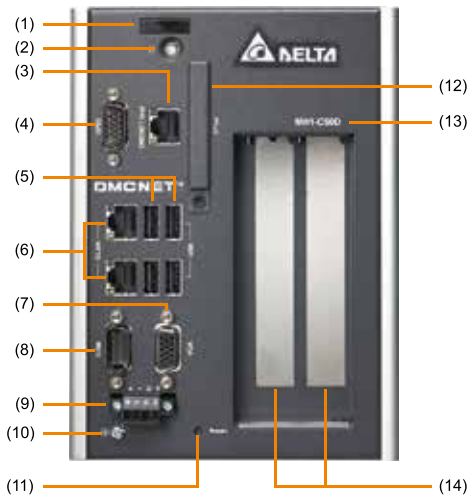

MH1-A12/C50/C70 N Series

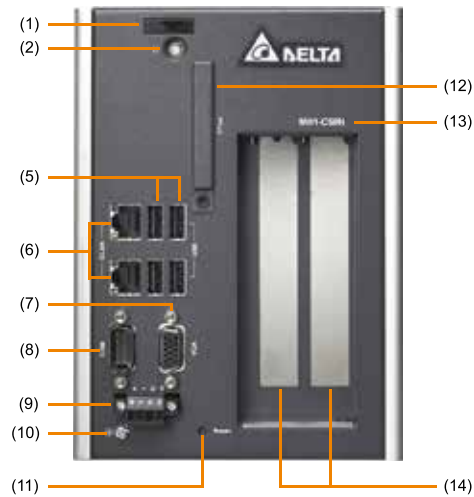

Interface			
(1)	LED Indicator	(8)	RS-232
(2)	Power Switch	(9)	Power Supply Port
(3)	DMCNET Communication*	(10)	Ground Wire Screw
(4)	GPIO Connector*	(11)	Reset Switch
(5)	USB 2.0 Port	(12)	CFast Card Slot
(6)	Gigabit LAN Connector	(13)	Product Number
(7)	VGA Output Connector	(14)	PCI / PCI Extension Slot

# Model Explanation

## MH1 Series

**M H 1 - A 1 2 D - A 0 3 DG**

### Product Name:

Motion Control Host 1<sup>st</sup> Generation

### CPU Information:

A12 = Intel Atom E3845 Quad Core 1.91 GHz  
 C50 = Intel Core i5-3610ME Dual Core 2.7 GHz  
 C70 = Intel Core i7-3612QE Quad Core 2.1 GHz

### Communications:

D = DMCNET  
 N = N/A or EtherCAT  
 E = 2-channel EtherCAT

### Extension Slot Interface:

0 = No Extension Slot  
 A = 2 PCI slots  
 C = 2 PCIe slots x4 + x1

### Product Version:

DG=Windows 7 Embedded(32 bit)  
 DH=Windows 7 Embedded(64 bit)  
 DM=Windows 7Embedded(32 bit)  
 +IMP(IPC Motion Platform)

\* Please refer to Ordering Information for actual versions

### CFast card and SSD card:

SSD \ CFast	None	16GB	32GB
None	0	1	3
16GB	2	-	-
32GB	6	-	-
64GB	4	-	-
128GB	5	-	-

### DRAM and Micro-SD (eMMC):

SD \ DRAM	None	2GB	4GB	8GB	4GB+ 4GB
None	-	1	0	-	3
4GB	-	-	-	-	-
8GB	-	-	-	-	-
4GB+4GB	2	-	-	-	-

# Ordering Information

## Specifications

Model Name		MH1-A12 D/E/N	MH1-C50 D/E/N	MH1-C70 D/E/N	
Processor System	Processor	Intel Atom E3845 Quad Core 1.91 GHz	Intel Core i5-3610ME Dual Core 2.7 GHz	Intel Core i7-3612QE Quad Core 2.1 GHz	
	System Chipset	N/A			
	BIOS	AMI BIOS			
	MRAM	2 x DDR3-1600 Default 4 GB, Max 16 GB, support ECC			
I/O Interface	System Memory	128 KB MRAM	128 KB MRAM		
	CRT	2560x1600 / 60Hz	2048x1536 / 75 Hz		
	Internet	2 x IEEE 802.3/802.3u/802.3ab 1 Gbps			
	Communication	DMCNET™ (12-Axis) - (A12D/C50D/C70D Series) N/A - (A12N/C50N/C70N Series)			
	USB	4 x USB 2.0			
	Serial Port	1 x RS-232 (Hardware auto flow control)			
	Digital Input	1-CH isolated, Sink type, 24 V <sub>DC</sub> (5 mA/CH) - (A12D/C50D/C70D Series)			
	Digital Output	1-CH isolated, Sink type, 24 V <sub>DC</sub> (10 mA/CH) - (A12D/C50D/C70D Series)			
	Encoder Input	2-CH isolated, EA± / EB± - (A12D/C50D/C70D Series)			
	Compare Output	2-CH isolated, CMP± - (A12D/C50D/C70D Series)			
	Expansion <sup>1</sup>	2 x PCI slot or 1 x PCIe x4 slot + 1 x PCIe x1 slot (C50/C70 Series) 2 x PCI slot or 1 x PCIe x1 slot + 1 x PCIe x1 slot (A12E/N Series) 2 x PCI slot (A12D Series)			
		1 x CFast Card (optional) 1 x 2.5" SATA SSD (optional)			
Storage	CFast Card				
	Solid State Disk <sup>1</sup>				
Power Requirements	Input Voltage	15 ~ 30 V <sub>DC</sub>			
	Power Consumption <sup>2</sup>	24V / 1A / 24W	24V / 1.25A / 30W	24V / 1.42A / 34W	
Mechanical	Mounting	Desk / Wall-mounting			
	Dimensions (W x H x D)	3.4 kg	3.9 kg	3.9 kg	
	Weight	127 x 175 x 250 mm (W x H x D)			
Environment	Operation Temperature	0°C ~ 50°C			
	Storage Temperature	-30°C ~ 85°C			
	Humidity	0% ~ 90% RH (non-condensing)			
	Anti-pollution Degree	Pollution Degree 2			
	Vibration Resistance	2 Grms, IEC 60068-2-64, random, 5 ~ 500 Hz, 1 hr/axis			
	Shock Resistance	75 G, IEC 60068-2-27, half sine, 11 ms duration			
Software Support	Safety Certification	CE			
	Microsoft Windows	Window 7.0, Window 7 Embedded	Window 7.0, Window XP Embedded, Window 7 Embedded		

Note 1. Max power constraint: PCIe x4 (25W), PCIe x1 (10W), PCI (10W), SSD (5W), CFast (5W), POE (72W)

Note 2. CPU under full load; external storage (CFast Card / SSD), PCI / PCIe Card or POE excluded

# Dimensions

## MH2-P10N

- ▶ Dimensions: 54.2 mm(W) × 141 mm(H) × 137.5 mm(L)
- ▶ Dimensions (Accessories included): 54.2 mm(W) × 164 mm(H) × 166.8 mm(L)

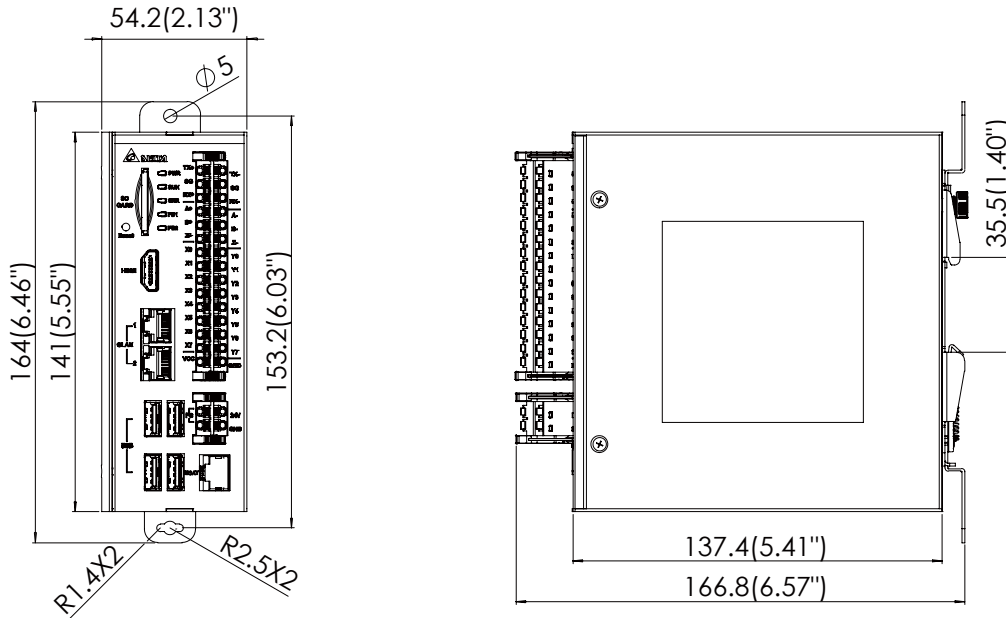

## Exterior Description

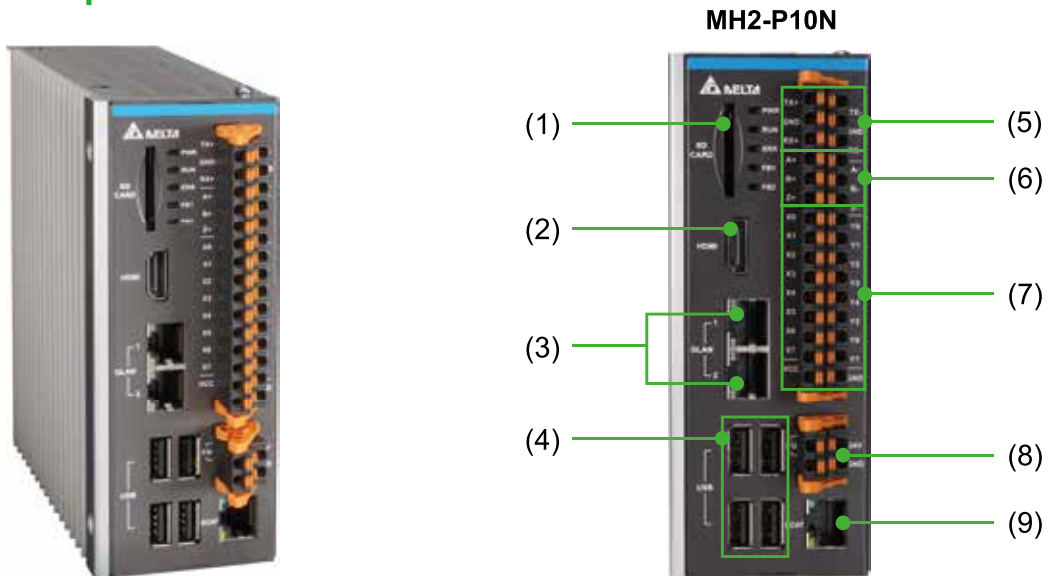

Interface	
(1) SD Card Slot	(6) Encoder Input Port
(2) HDMI Output Terminal	(7) GPIO Connector
(3) Gigabit LAN Port	(8) Power Connector
(4) USB 2.0	(9) EtherCAT COM Port
(5) RS-422/485 Serial COM Port	



# Model Name

## MH2 Series

**M H 2 - P 1 0 N - N 0 6 D N**

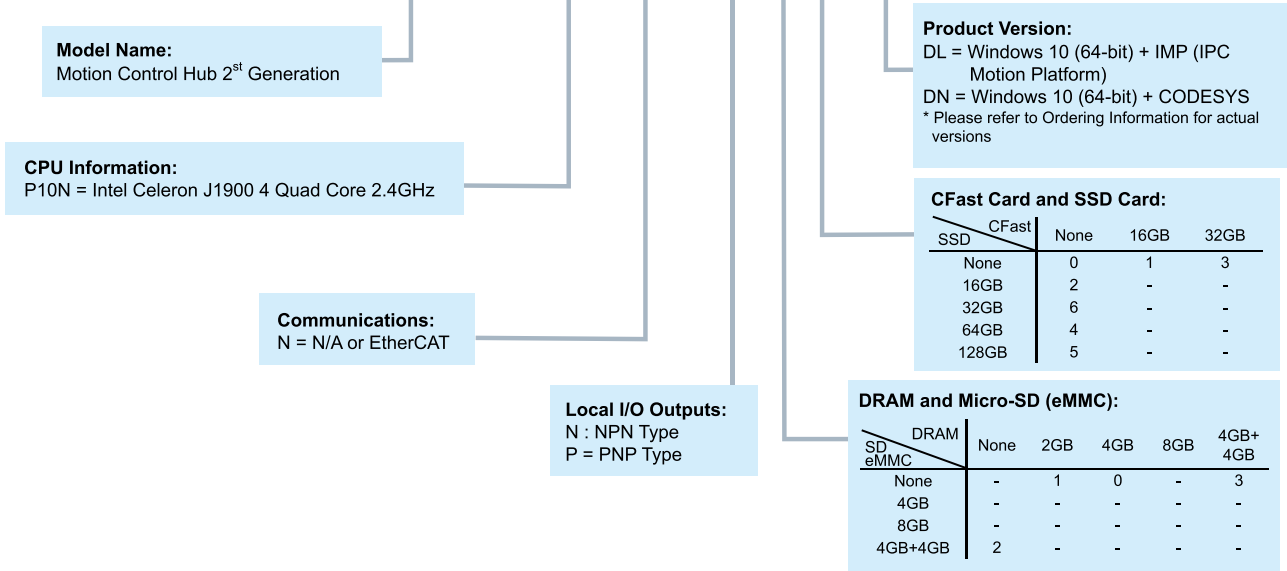

# Ordering Information

## Specifications

Model Name		MH2-P10N
Processor	CPU	Intel Celeron J1900 Quad Core, 2.4GHz
	BIOS	AMI BIOS
	Memory	Built-in DDR3L-1333 4GB
	Nonvolatile Memory	128kB MRAM
Display	HDMI	HDMI 1.4a × 1
	USB	USB 2.0 × 4
Input / Output	Ethernet	2 × IEEE 802.3/802.3u/802.3ab 1G bps (Intel I210AT)
	Fieldbus	EtherCAT (Intel I210AT) × 1
	Serial Port	Isolated RS-485/RS-422 × 1
	Digital Input	8-CH high-speed isolated input, Sink / Source type, 24 VDC (5 mA/CH)
	Digital Output	8-CH high-speed isolated output, Source type, 24 VDC (200 mA/CH)
	Encoder Input	(Incremental) 1-CH isolated, (EA± / EB± / EZ±) × 1 (Absolute) 1-CH isolated (TX± / RX±) (use RS-422 I/F)
	Storage	HDD
SD Card		SD card slot × 1
MISC.	Security IC	Built-in software system protection security IC × 1
	LEDs	LED display (PWR/RUN/ERR/FB1/FB2) × 5
	Watchdog	Supports Watchdog function
Power Supply Requirement	Input Voltage	DC 24V ± 15%
	Power Consumption	24V/2A/48W
	Power Loss Detection	Low voltage detection and power loss data saving
Mechanism	Installation	Wall-mounted / Slide
	Dimensions	54.2 × 141 × 137.5 mm (W × H × D)
Ambient Environment	Operating Temperature	0°C ~ 50°C
	Storage Temperature	-30°C ~ 85°C
	Relative Humidity	0% ~ 90% RH (Non-condensing)
	Vibration Resistance	2 Grms, IEC 60068-2-64, Random continuous shock, 5 ~ 500 Hz, 1 hr/axis
	Shock Resistance	75G IEC 60068-2-27, Half Sinusoid, Continuous for 11ms
	Certification	EN 55022 : 2010 · EN 55024 (EN55011 : 2010)
Software	Microsoft Windows	Window 10 IoT
	Real-time OS	RTE (based on CODESYS)

# Dimensions

## MP1-A10D-10 Series

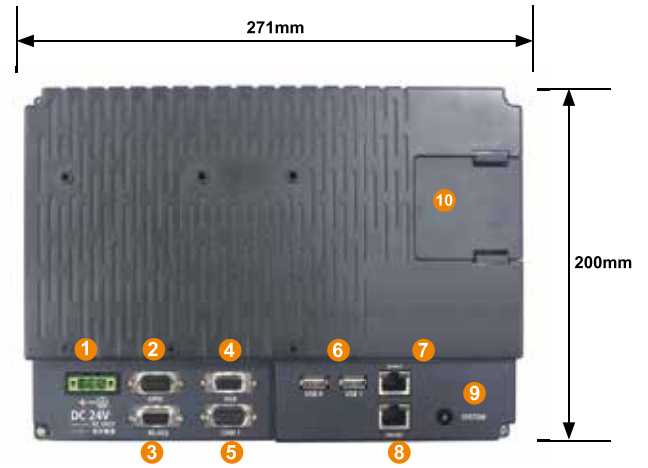
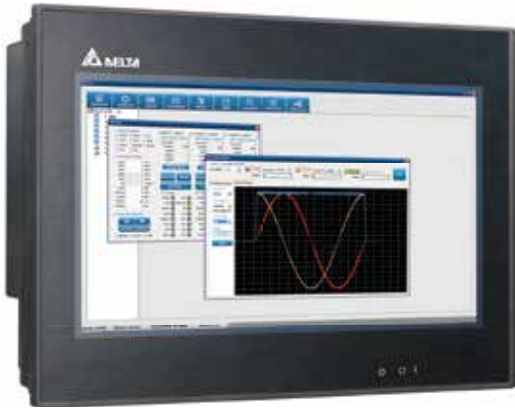

### Exterior Description

A	24V <sub>DC</sub> Power Input
B	Digital Input / Output Port (8 inputs / 4 outputs)
C	RS-422 / RS-485
D	VGA Output Connector
E	RS-232

F	2 x USB 2.0 Ports
G	1 Gbps Ethernet Port
H	DMCNET Communication
I	Reset Switch
J	CFast Card Slot

## MP1-P10D-15 Series

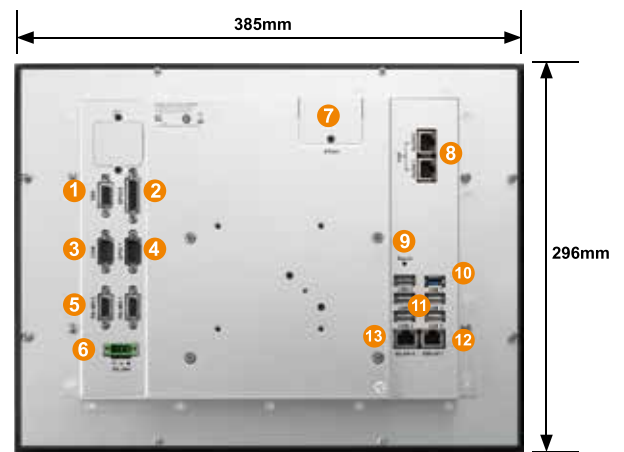

### Exterior Description

(1)	VGA Output Connector
(2)	Digital Input/ Output Port (12 inputs / 12 outputs)
(3)	MPG Input
(4)	Digital Input/ Output Port (QEP x 2 / CMP x 2)
(5)	2 x RS-485
(6)	24V Power Input
(7)	CFast Card Slot

(8)	2 x Gigabit LAN Ports
(9)	Reset Switch
(10)	1 X USB 3.0
(11)	5 X USB 2.0
(12)	DMCNET Communication
(13)	1 x Gigabit LAN Port

# Model Explanation

## MP1Series

**M P 1 - P 1 0 D - 1 5 0 3 D J**

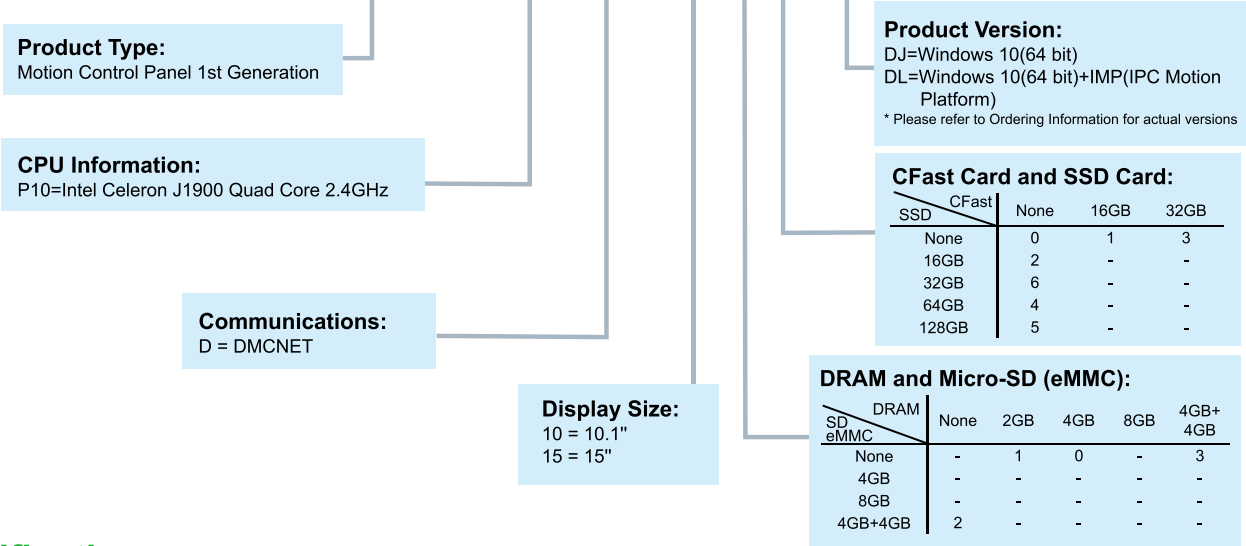

## Specifications

Model Name		MP1-A10D-10	MP1-P10D-15
Processor System	Processor	Intel Atom E3825 Dual Core 1.33GHz	Intel Atom J1900 Quad Core 2.4GHz
	MRAM	128KB	
	BIOS	AMI BIOS	
	System Memory	DDR3L-1333 2 GB, supports ECC	DDR3L-1333 4GB, supports ECC
Display Interface	LCD Panel	10.1" TFT LCD (262,144 color) 1024 x 600 pixels (WXGA) / LED backlight 222.72(H) x 125.28 (V) mm	15" TFT-LCD (262k / 16.7M color) 1024 x 768 pixels (XGA), LED backlight 304.1 (H) x 228.1 (V) mm
	Touch Panel	4-wire Resistive (Max. 10-bit Resolution)	
	LED	POWER / RUN / ERROR	
	CRT	2560 x 1600 / 60Hz	
I/O Interface	Ethernet	1 x IEEE 802.3 / 802.3u / 802.3ab 1Gbps	3 x IEEE 802.3 / 802.3u / 802.3ab 1Gbps
	DMCNET	O	
	USB	2 x USB 2.0	1 x USB 3.0 5 x USB 2.0
	Serial Port	1 x isolated RS-232 1 x isolated RS-422/485	2 x isolated RS-422 / 485
	Digital Input	8-CH isolated, 24V <sub>DC</sub> Sink / Source (5mA / CH)	1-CH isolated, Sink type, 24V <sub>DC</sub> (5mA / CH) 12-CH isolated, Sink / Source type, 24V <sub>DC</sub> (5mA / CH)
	Digital Output	4-CH isolated, 24V <sub>DC</sub> Sink (500mA / CH)	1-CH isolated, Sink type, 24V <sub>DC</sub> (10mA / CH) 12-CH isolated, Sink type, 24V <sub>DC</sub> (200mA / CH)
Storage	CFast Card	1 x CFast Card (optional)	
	eMMC	1 x eMMC (optional)	
Power Requirements	Solid State Disk	Build-in 16GB SSD	1 x 2.5" SATA SSD (optional)
	Input Voltage	12~30V <sub>DC</sub>	12~30V <sub>DC</sub>
	Power Consumption <sup>1</sup>	24V/0.7A/16.8W	TBD
Mechanical	Mounting	Wall-mounting	
	Dimensions (W x H x D)	271 x 200 x 61 mm (10.66" x 7.87" x 2.4" )	385 x 296 x 55 mm
	Weight	1.75 kg	3.18 kg
Environment	Operating Temperature	0° C ~ 50° C	
	Storage Temperature	-30° C ~ 60° C	
	Humidity	0% to 90% RH (non-condensing)	
	Vibration Resistance	2 Grms, IEC 60068-2-64, random, 5 ~ 500 Hz, 1 hr / axis	
	Shock Resistance	75 G, IEC 60068-2-27, half sine, 11 ms duration	
	Safety Certification	CE	
	Windows 7.0 / 7 Embedded	O	

1. Full load power consumption without CFast/SSD or any PCI/PCIe card  
2. Please contact Delta for expanding RAM/SSD or changing OS

# DMCNET Remote Modules

## Digital Input Remote Modules

- ASD-DMC-RM32MN (32 Digital Inputs)
- ASD-DMC-RM64MN (64 Digital Inputs)
- ASD-DMC-RM32PT (16 Digital Inputs / 16 Digital Outputs)

## Electrical Specifications

Model Name	RM32MN / RM64MN / RM32PT
Input Circuit Type	Single common port input
Input Signal Type	SINK / SOURCE
Input Signal Voltage	24 V <sub>DC</sub> (5mA)
Response Time	0 to 3 ms, adjustable
Action Level (OFF > ON)	> 16.5V <sub>DC</sub>
Action Level (ON > OFF)	< 8V <sub>DC</sub>
Noise Tolerance Threshold	ESD (IEC 61131-2, IEC 61000-4-2): 8 KV Air Discharge EFT (IEC 61131-2, IEC 61000-4-4): Power Line: 2KV, Communication I/O: 1KV RS (IEC 61131-2, IEC 61000-4-3): 80MHz ~ 1GHz, 10V/m
Environment	Operating Temperature: 0°C ~ 50°C Storage Temperature: -20°C ~ 70°C

## Installation & Wiring

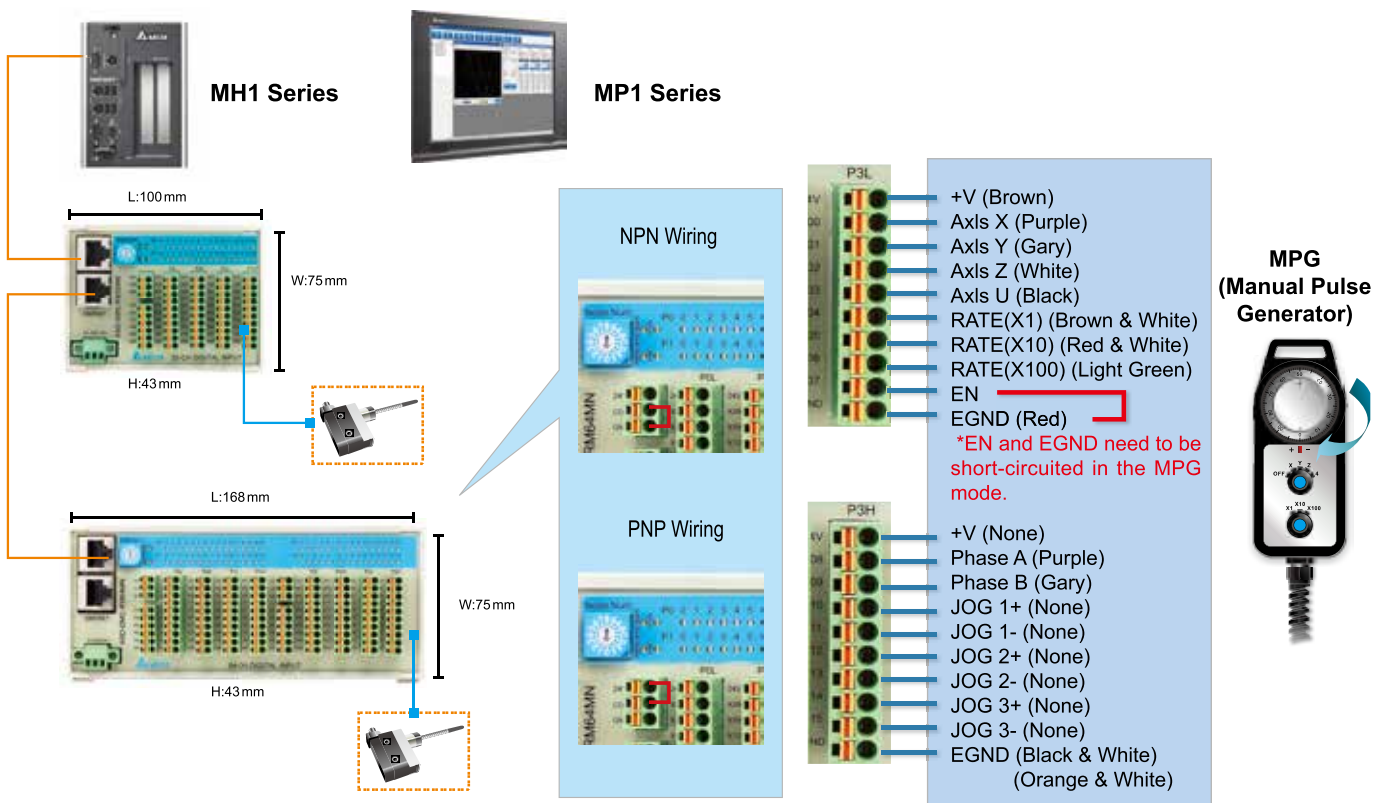

\*MPG can only be used for the terminals of P3H and P3L of ASD-DMC-RM64MN.

## Digital Output Remote Modules

- ASD-DMC-RM32NT (32 Digital Outputs)
- ASD-DMC-RM64NT (64 Digital Outputs)
- ASD-DMC-RM32PT (16 Digital Inputs / 16 Digital Outputs)
  - Non-volatile memories can be managed through a software API
  - Load Output: 0.1A / 1 Point

## Electrical Specifications

Model Name	RM32NT / RM64NT
Output Circuit Type	Transistor
Output Signal Type	SINK
Current Specifications	0.1A/1 point
Voltage Specifications	24V <sub>DC</sub>
Maximum Switching (Operating) Frequency	1 KHz
Action Level (OFF > ON)	20 us
Action Level (ON > OFF)	30 us
Noise Tolerance Threshold	ESD (IEC 61131-2, IEC 61000-4-2): 8 KV Air Discharge EFT (IEC 61131-2, IEC 61000-4-4): Power Line: 2KV, Communication I/O: 1KV RS (IEC 61131-2, IEC 61000-4-3): 80MHz ~ 1 GHz, 10V/m
Environment	Operating Temperature: 0°C ~ 50°C Storage Temperature: -20°C ~ 70°C

## Installation & Wiring

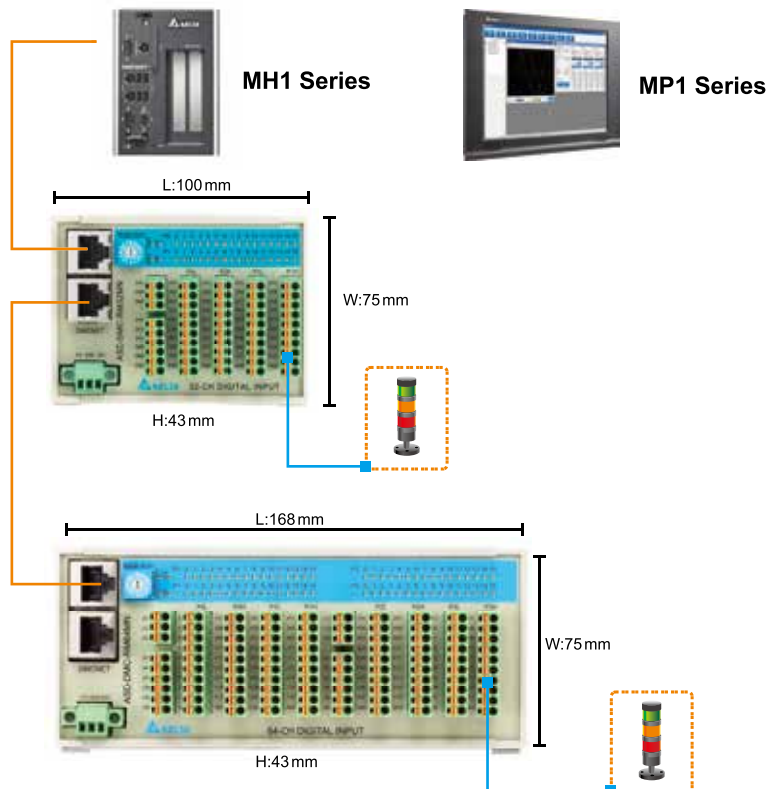

# DMCNET Remote Modules

## • ASD-DMC-RM04PI (4-Channel Pulse)

- 4 channels of 200 kHz pulse outputs (Pulse +Direction, CCW pulse +CW pulse, A phase + B phase)
- 4 channels of 200 kHz pulse inputs (CCW pulse +CW pulse, A phase + B phase)
- Digital Inputs x8 / Digital Outputs x8
- Built-in Positive / Negative Limit and Home for each channel
- In Mode 1, each RM04PI module occupies one node number only, and interpolation motion is carried out within one module.
  - 4 channels occupy 1 node number only
  - 4 channels occupy one PDO and SDO
  - Performs interpolation motion of 4 channels within one RM04PI module only
  - Transfers data in cyclical patterns
  - Motion commands set by parameters
  - Point-to-Point motion mode, motion position calculation is performed within one RM04PI module
- In Mode 2, each RM04PI module occupies node numbers 1~4, which correspond to 4 channels. The interpolation motion can be carried out among different modules.

## Electrical Specifications

ASD-DMC-RM04PI	
Item	Input (QA, QB, QZ, DI1, DI2)
Circuit Type	Single
Signal Type	SINK
Power Supply Voltage	5V <sub>DC</sub>
Work Frequency	QA, QB, QZ: 200kHz (5 mA / 1 point) DI1, DI2: 1kHz (5 mA / 1 point)
Noise Immunity	ESD (IEC 61131-2, IEC 61000-4-2): 8 KV Air Discharge EFT (IEC 61131-2, IEC 61000-4-4): Power Line: 2KV Communication I/O: 1 KV RS (IEC 61131-2, IEC 61000-4-3): 80 MHz ~ 1 GHz, 10V/m
Operating/Storage Environment	Operating: 0°C ~ 50°C (32°F ~ 122°F) Storage: -20°C ~ 70°C (-4°F ~ 158°F)

ASD-DMC-RM04PI		
Item	Input (MEL, PEL, ORG, SLD)	Output (CW, CCW, DO1, DO2)
Circuit Type	Single	Transistor
Signal Type	SINK / SOURCE	SINK
Power Supply Voltage	24 V <sub>DC</sub> (5 mA)	5~24 V <sub>DC</sub> (30 mA / 1 point)
Response Time/Work Frequency	1 ms	CW, CCW: 200 kHz DO1, DO2: 1 kHz
Active Level (OFF > ON)	> 16.5V <sub>DC</sub>	-
Active Level (ON > OFF)	< 8V <sub>DC</sub>	-
Noise Immunity	ESD (IEC 61131-2, IEC 61000-4-2): 8 KV Air Discharge EFT (IEC 61131-2, IEC 61000-4-4): Power Line: 2KV Communication I/O: 1 KV RS (IEC 61131-2, IEC 61000-4-3): 80 MHz ~ 1 GHz, 10V/m	
Operating/Storage Environment	Operating: 0°C ~ 50°C (32°F ~ 122°F) Storage: -20°C ~ 70°C (-4°F ~ 158°F)	

## Installation & Wiring

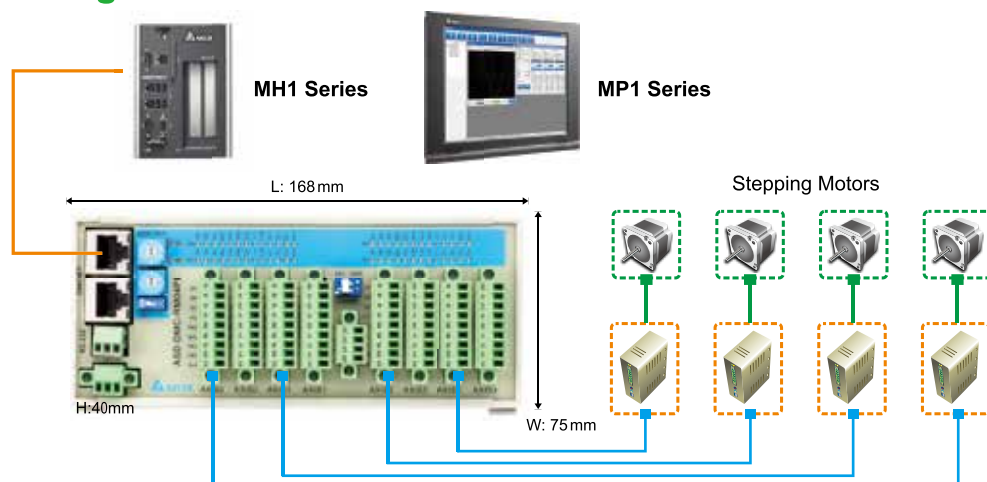

- **ASD-DMC-RM04AD (4-Channel Analog Input)**

### Electrical Specifications

ASD-DMC-RM04AD	
Channel	4 Channels / module
Voltage Analog Input Range	-10 ~ 10 V / -5 ~ 5 V / 0 ~ 10 V / 0 ~ 5 V
Current Analog Input Range	0 ~ 24 mA
Digital Conversion Range	0 ~ 65535
Resolution	16 bits
Voltage Input Resistance	140 kΩ
Current Input Resistance	249 Ω
General Precision	Within ±0.5% (25°C, 77 °F) at full scale Within ±1% (0 ~ 55°C, 32 ~ 131 °F) at full scale
Response Time	Min. 1 ms / Max. 3 ms × the number of channels.
Isolation	Internal circuit and analog output terminals are isolated with an optical coupler
Voltage Absolute Input Range	-15 ~ 15
Current Absolute Input Range	32 mA
Digital Data Format	16 significant bits
Sampling Mode	Five modes which the average number is two (2), four (4), eight (8), sixteen (16) and thirty-two (32) are available for selection.

### Installation & Wiring

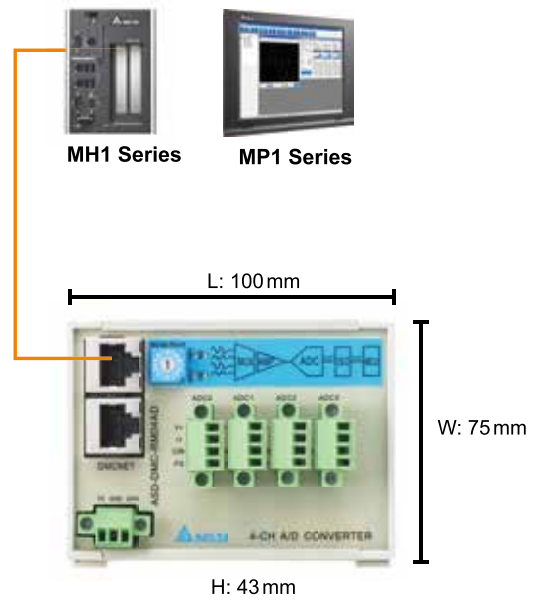

- **ASD-DMC-RM04DA (4-Channel Analog Output)**

### Electrical Specifications

ASD-DMC-RM04DA	
Channel	4 Channels / module
Voltage Output Range	-10 ~ 10 V / -5 ~ 5 V / 0 ~ 10 V / 0 ~ 5 V
Current Output Range	0 ~ 24 mA / 0 ~ 20 mA / 4 ~ 20 mA
Excess Limit (Voltage)	10 %
Maximum Output Current (Voltage)	20 mA
Allowable Load Resistance (Current)	0 ~ 500 Ω
Digital Data Range	0 ~ 4096
Resolution	16 bits
DC Output Resistance	0.3 Ω
Response Time	1 ms
Digital Data Format	16 bits
Isolation	Internal circuit and analog output terminals are isolated with an optical coupler
Protection	Voltage output is protected by short circuit, but must be aware of long-lasting short circuit damaging the internal circuits

### Installation & Wiring

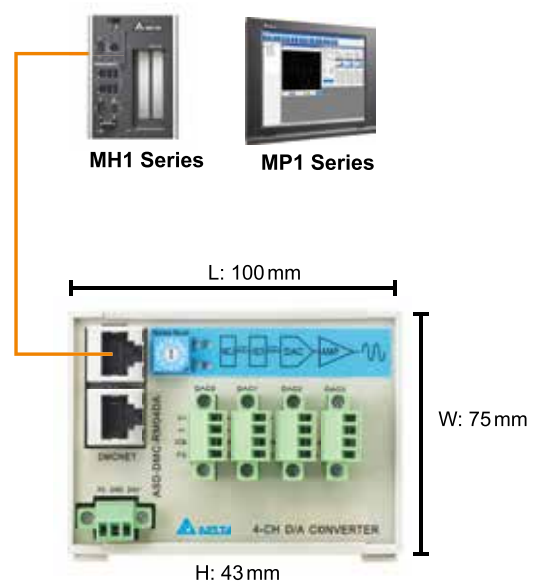

# DMCNET Remote Modules

## • HMC-RIO3232RT5 (Digital I/O Remote Module)

- 16 points relay type output unit, Max. loading: 2A / 1 Point with non-volatile memory function
- 16 points transistor type output unit, Max. loading: 0.1A / 1 Point
- 32 points digital input unit – supports SINK and SOURCE modes

## Electrical Specifications

Item	HMC-RIO3232RT5
Supply Voltage	24V <sub>DC</sub> (15% ~ 20%)
Power Consumption	1.2W
Noise Immunity	RS: Frequency: 80MHz ~ 1GHz, 1.4GHz ~ 2.0GHz, Test level 10V/m ESD: Contact discharge ±8KV Air discharge ±8KV EFT: ±2KV(Power port), ±2KV (I/O line), Surge: ±2KV (RIO power port)
Temperature	Operating: 0°C ~ 55°C (Temperature), 10 ~ 90% (Humidity); Storage: -20°C ~ 60°C (Temperature), 10 ~ 90% (Humidity)
Vibration	IEC 61131-2 compliant 5Hz ~ 8.3Hz = Continuous: 3.5mm, 8.3Hz ~ 150Hz = Continuous: 1.0g
Shock	IEC 60068-2-27 compliant 15g peak for 11 ms duration X, Y, Z directions for 6 times
Weight	Approx. 460g

Item	Input Port	Item	Output Port
Input Signal Type	SINK / SOURCE	Output Circuit Type	Transistor / Relay
Input Signal Voltage	24V <sub>DC</sub> (5 mA)	Voltage Specifications	24 V <sub>DC</sub> (-10% ~ +15%) / < 250 V <sub>AC</sub> (Relay Only)
Input Impedance	4.7K ohm	Current Specifications	100 mA / 1 Point (Transistor), 2A / 1 Point (Relay), Resistive Load
Action Level	(OFF → ON) > 16.5V <sub>DC</sub> (ON → OFF) < 5V <sub>DC</sub>	Max. Switching (Operating) Frequency	8 kHz (TR) / 1 Hz (RELAY)
		Response Time	TR: (ON → OFF) :115 μs, (OFF → ON) : 12 μs RELAY: (ON → OFF) :10ms, (OFF → ON) : 10ms

## Installation & Wiring

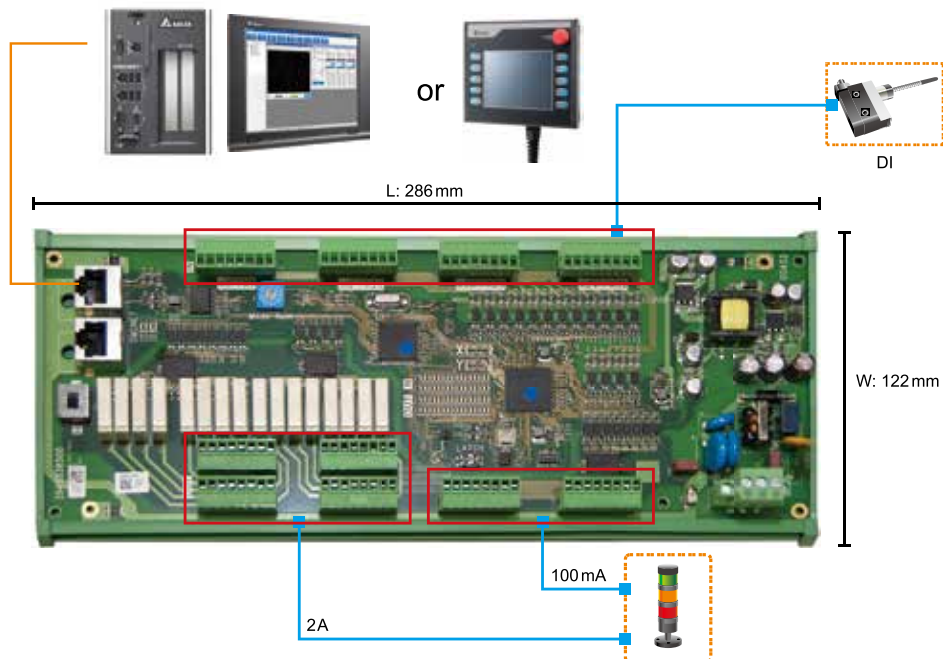



# Gateway Type Remote Power Coupler

## Master Module - GA Series



- One GA01 can connect up to a maximum of 4 GE remote modules, of which there may be a maximum of four GE01PH modules.
- One GE01PH module occupies one node number.
- The EzDMC provides a software auto calculation function for calculating the numbers of start and end stations of the ASD-DMC-GA01.

## ASD-DMC-GA01 Switching Settings



ADDR1		
PIN	Function	Explanation
1 ~ 12	Start Node Address	Start Station

  

ADDR2		
PIN	Function	Explanation
1 ~ 12	End Node Address	End Station

ADDR1 & ADDR2  
 There is no communication when the value is set to 0 and 13 ~ 15.  
 When ADDR1 is set to 1 and ADDR2 is set to 2, it indicates that the remote modules have occupied two stations.

# Gateway Type Digital I/O Remote Module

## Slave Module - GE Series

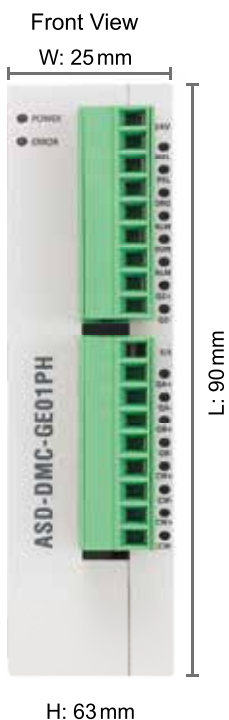

- Gateway Type 1-Channel Pulse Remote Module  
**ASD-DMC-GE01PH**



## Electrical Specifications

ASD-DMC-GE01PH		
Item	Input	Output
Circuit Type	Single common port input	Transistor
Signal Type	SINK / SOURCE	SINK
Signal Voltage	24 V <sub>DC</sub> (5 mA)	5 ~ 24 V <sub>DC</sub> (30 mA/1 point)
Response Time	1 ms	
Maximum Input Pulse Frequency	QA+, QB+, QZ+, QA-, QB-, QZ- : 4 MHz (5 mA / 1 point)	CW, CCW : 4 MHz (30 mA / 1 point) SVON, RALM : 1 kHz (30 mA / 1 point)
Action Level (OFF > ON)	> 16.5 V <sub>DC</sub>	-
Trigger Level (ON > OFF)	< 8 V <sub>DC</sub>	-
Output Circuit Type	-	RS-422
Output Signal Type	-	differential

# ASDA-A3-F Servo Drive Specifications



ASDA-A3		100 W	200 W	400 W	750 W	1 kW	1.5 kW	2 kW	3 kW	
		01	02	04	07	10	15	20	30	
Power supply	Phase / Voltage	Single-phase / three-phase 220 VAC						Three-phase 220 VAC		
	Permissible Voltage Range	Single-phase / three-phase 200~230 VAC, -15%~10%						Three-phase 200~230 VAC, -15%~10%		
	Input Current(3PH) (Units: Arms)	0.67	1.34	2.67	5.01	6.68	10.02	13.36	20.05	
	Input Current(1PH) (Units: Arms)	1.16	2.31	4.63	8.68	11.57	17.36	-	-	
	Continuous Output Current (Units: Arms)	0.9	1.55	2.65	5.1	7.3	12.6	13.4	19.4	
	Instantaneous Maximum Output Current (Units: Arms)	3.54	7.07	10.61	21.21	24.75	35.36	53.03	70.71	
Cooling System		Natural Air Circulation			Fan Cooling					
Drive resolution		24-bit (16777216 p/rev)								
Control of Main Circuit		SVPWM Control								
Tuning Modes		Auto / Manual								
Regenerative Resistor		None			Built-in					
Position Control Mode	Pulse Type (Only for Non-DMCNET mode)	Pulse + Direction, A phase + B + CW pulse								
	Max. Input Pulse Frequency (Only for Non-DMCNET mode)	Pulse + Direction: 4Mpps ; CCW pulse + CW pulse: 4Mpps ; A phase + B phase: Single phase 4Mpps ; Max. 200Kpps (Open collector)ppps								
	Command Source	External pulse train (PT mode) (Only for Non-DMCNET mode) / Internal parameters (PR mode)								
	Smoothing Strategy	Low-pass and P-curve filter								
	Electronic Gear	Electronic gear N/M multiple N: 1~536870911, M: 1~2147483647 (1/4 < N/M < 262144)								
	Torque Limit Operation	Set by parameters								
	Feed Forward Compensation	Set by parameters								

ASDA-A3			100 W	200 W	400 W	750 W	1 kW	1.5 kW	2 kW	3 kW	
			01	02	04	07	10	15	20	30	
Speed Control Mode	Analog Input Command (Only for Non-DMCNET mode)	Voltage Range	0 ~ ±10 V <sub>DC</sub>								
		Resolution	15-bit								
		Input Resistance	1MΩ								
		Time Constant	25 μs								
	Speed Control Range <sup>*1</sup>	1 : 6000									
	Command Source	External analog signal (Only for Non-DMCNET mode) / Internal parameters									
	Smoothing Strategy	Low-pass and S-curve filter									
	Torque Limit Operation	Set by parameters or analog input (Only for Non-DMCNET mode)									
	Frequency Response Characteristic	Maximum 3.1kHz									
	Speed Accuracy <sup>*2</sup>	0.01% or less at 0 to 100% load fluctuation									
0.01% or less at ±10% power fluctuation											
0.01% or less at 0°C to 50°C ambient temperature fluctuation											
Torque Control Mode	Analog Input Command (Only for Non-DMCNET mode)	Voltage Range	0 ~ ±10 V <sub>DC</sub>								
		Input Resistance	1 MΩ								
		Time Constant	25 μs								
	Command Source	External analog signal (Only for Non-DMCNET mode) / Internal parameters									
Smoothing Strategy	Low-pass filter										
Speed Limit	Set by parameters or analog input (Only for Non-DMCNET mode)										
Analog Monitor Output	Monitor signal can set by parameters (Output voltage range: ±8V)										
Digital Inputs / Outputs	Inputs	<p>Servo on, Reset, Gain switching, Pulse clear, Zero speed CLAMP, Command input reverse control, Command triggered, Speed/Torque limit enabled, Position command selection, Motor stop, Speed position selection, Position / Speed mode switching, Speed / Torque mode switching, Torque / Position mode switching, PT / PR command switching, Emergency stop, Forward / Reverse inhibit limit, Reference "Home" sensor, Forward / Reverse operation torque limit, Move to "Home", Electronic Cam (E-Cam), Forward / Reverse JOG input, Event trigger PR command, Electronic gear ratio (Numerator) selection and Pulse inhibit input</p> <p><small>* Please note that the above digital signals and inputs are available only for Non-DMCNET mode. In DMCNET mode, it is recommended to write digital inputs into the servo drives through DMCNET communication, and the digital inputs should be used for Emergency Stop, Forward / Reverse Inhibit limit and Reference "Home" sensor only.</small></p>									
	Outputs	<p>Encoder signal output (A, B, Z Line Driver and Z Open Collector )</p> <p>Servo ready, Servo on, At Zero speed, At Speed reached, At Positioning completed, At Torques limit, Servo alarm (Servo fault) activated, Electromagnetic brake control, Homing completed, Output overload warning, Servo warning activated, Position command overflow, Forward / Reverse software limit, Internal position command completed, Capture operation completed output., Motion control completed output., Master position of E-Cam (Electronic Cam)</p>									
Protective Functions	Overcurrent, Overvoltage, Undervoltage, Motor overheated, Regeneration error, Overload, Overspeed, Abnormal pulse control command, Excessive deviation, Encoder error, Adjustment error, Emergency stop activated, Reverse/ Forward limit switch error, Position excessive deviation of full-close control loop, Serial communication error, Input power phase loss, Serial communication time out, short circuit protection of U, V, W, and CN1, CN2, CN3 terminals										
Communication Interface	RS-485 / CANopen / USB										
Environment	Installation Site	Indoor environment (free of direct sunlight), no corrosive liquid and gas (free of oil mist, flammable gas, or dust)									
	Altitude	Altitude 1000m or lower above sea level									
	Atmospheric Pressure	86kPa ~ 106kPa									
	Operating Temperature	0°C ~ 55°C (If operating temperature is above 45°C, forced cooling will be required)									
	Storage Temperature	-20 °C ~ 65 °C									
	Humidity	0 ~ 90% RH (non-condensing)									
	Vibration	9.80665 m/s <sup>2</sup> (1G) less than 20Hz, 5.88 m/s <sup>2</sup> (0.6G) 20 to 50Hz									
	IP Rating	IP20									
	Power System	TN System <sup>*3,4</sup>									
	Approvals	IEC/EN 61800-5-1 · UL 508C  									

Note: \*1. When it is with the rated load, the speed ratio is: the minimum speed (smooth operation) / rated speed.

\*2. When the command is the rated speed, the velocity correction ratio is: (free run speed - full load speed) / rated speed



\*3. TN system: The neutral point of the power system connects to the ground directly. The exposed metal components connect to the ground via the protective earth conductor.

\*4. Use a single-phase three-wire power systems for models of single-phase power

# ASDA-A2-F DMCNET Servo Drive Specifications



ASDA-A2-F Series		100W	200W	400W	750W	1kW	1.5kW	2kW	3kW	4.5kW	5.5kW	7.5kW
		01	02	04	07	10	15	20	30	45	55	75
Power Supply	Phase / Voltage	Three-phase / Single-phase 220V <sub>AC</sub>						Three-phase 220V <sub>AC</sub>				
	Permissible Voltage Range	Single-phase / Three-phase 200 ~ 230V <sub>AC</sub> , -15% ~ 10%						Three-phase 200 ~ 230V <sub>AC</sub> , -15% ~ 10%				
	Input Current (3PH) (Units: Arms)	0.39	1.11	1.86	3.66	4.68	5.9	8.76	9.83	17.5	19.4	26.3
	Input Current (1PH) (Units: Arms)	0.69	1.92	3.22	6.78	8.88	10.3	-	-	-	-	-
	Continuous Output Current (Units: Arms)	0.9	1.55	2.6	5.1	7.3	8.3	13.4	19.4	32.5	40	47.5
Cooling System		Natural Air Circulation				Fan Cooling						
Encoder Resolution / Feedback Resolution		Incremental encoder: 20-bit (1280000 p/rev); Absolute encoder: 17-bit										
Control of Main Circuit		SVPWM (Space Vector Pulse Width Modulation) Control										
Tuning Modes		Auto / Manual										
Regenerative Resistor		None		Built-in						External		
Position Control Mode	Max. Input Pulse Frequency (Only for Non-DMCNET mode)	Max. 500Kpps / 4Mpps (Line driver), Max. 200Kpps (Open collector)										
	Pulse Type (Only for Non-DMCNET mode)	Pulse + Direction, A phase + B phase, CCW pulse + CW pulse										
	Command Source	External pulse train (PT mode) (Only for Non-DMCNET mode) / Internal parameters (PR mode)										
	Smoothing Strategy	Low-pass and P-curve filter										
	Electronic Gear	Electronic gear N/M multiple N: 1~32767, M: 1:32767 (1/50<N/M<25600)										
	Torque Limit Operation	Set by parameters										
	Feed Forward Compensation	Set by parameters										

ASDA-A2-F Series			100 W	200 W	400 W	750 W	1 kW	1.5 kW	2 kW	3 kW	4.5 kW	5.5 kW	7.5 kW
			01	02	04	07	10	15	20	30	45	55	75
Speed Control Mode	Analog Input Command (Only for Non-DMCNET mode)	Voltage Range	0 ~ ±10 V <sub>DC</sub>										
		Input Resistance	10 KΩ										
		Time Constant	2.2 μs										
	Speed Control Range <sup>1</sup>	1 : 5000										1 : 3000	
	Command Source	External analog signal (Only for Non-DMCNET mode) / Internal parameters											
	Smoothing Strategy	Low-pass and S-curve filter											
	Torque Limit Operation	Set by parameters or via analog input (Only for Non-DMCNET mode)											
	Frequency Response Characteristic	Max. 1 kHz											
	Speed Accuracy <sup>2</sup> (At rated rotation speed)	0.01% or less at 0 ~ 100% load fluctuation											
0.01% or less at ±10% power fluctuation													
0.01% or less at 0°C ~ 50°C ambient temperature fluctuation													
Torque Control Mode	Analog Input Command (Only for Non-DMCNET mode)	Voltage Range	0 ~ ±10 V <sub>DC</sub>										
		Input Resistance	10 KΩ										
		Time Constant	2.2 μs										
	Command Source	External analog signal (Only for Non-DMCNET mode) / Internal parameters											
	Smoothing Strategy	Low-pass filter											
	Speed Limit Operation	Set by parameters or via analog input (Only for Non-DMCNET mode)											
Analog Monitor Output			Monitor signal can set by parameters (Output voltage range: ±8 V)										
Digital Inputs / Outputs	Inputs <sup>3</sup>	Servo on, Reset, Gain switching, Pulse clear, Zero speed CLAMP, Command input reverse control, Command triggered, Speed/Torque limit enabled, Position command selection, Motor stop, Speed position selection, Position / Speed mode switching, Speed / Torque mode switching, Torque / Position mode switching, PT / PR command switching, Emergency stop, Forward / Reverse inhibit limit, Reference "Home" sensor, Forward / Reverse operation torque limit, Move to "Home", Electronic Cam (E-Cam), Forward / Reverse JOG input, Event trigger PR command, Electronic gear ratio (Numerator) selection and Pulse inhibit input											
	Outputs	Encoder signal output (A, B, Z Line Driver and Z Open Collector ) Servo ready, Servo on, At Zero speed, At Speed reached, At Positioning completed, At Torques limit, Servo alarm (Servo fault) activated, Electromagnetic brake control, Homing completed, Output overload warning, Servo warning activated, Position command overflow, Forward / Reverse software limit, Internal position command completed, Capture operation completed output., Motion control completed output., Master position of E-Cam (Electronic Cam)											
Protective Functions			Overcurrent, Overvoltage, Undervoltage, Motor overheated, Regeneration error, Overload, Overspeed, Abnormal pulse control command, Excessive deviation, Encoder error, Adjustment error, Emergency stop activated, Reverse/ Forward limit switch error, Position excessive deviation of full-close control loop, Serial communication error, Input power phase loss, Serial communication time out, short circuit protection of U, V, W, and CN1, CN2, CN3 terminals										
Communication Interface			RS-232 / RS-485 / CANopen / USB / DMCNET										
Environment	Installation Site		Indoor location (avoid direct sunlight), No corrosive liquid and gas (avoid oil mist, flammable gas, dust)										
	Altitude		Altitude 1000m or lower above sea level										
	Atmospheric Pressure		86 kPa ~ 106 kPa										
	Operating Temperature		0°C ~ 55°C (If operating temperature is above 45°C, forced cooling will be required)										
	Storage Temperature		-20°C ~ 65°C (-4°F ~ 149°F)										
	Humidity		0 ~ 90% RH (non-condensing)										
	Vibration		9.80665m/s <sup>2</sup> (1G) less than 20 Hz, 5.88 m/s <sup>2</sup> (0.6G) 20 ~ 50 Hz										
	IP Rating		IP20										
	Power System		TN System <sup>4</sup>										
Certifications			IEC/EN 61800-5-1, UL 508C, C-tick   US LISTED 										

<sup>1</sup> Rated rotation speed: When full load, speed ratio is defined as the minimum speed (the motor will not pause)

<sup>2</sup> When command is rated rotation speed, the speed fluctuation rate is defined as: (Empty load rotation speed - Full load rotation speed) / Rated rotation speed





<sup>3</sup> Please note that the above digital signals and inputs are available only for Non-DMCNET mode. In DMCNET mode, it is recommended to write digital inputs into the servo drives through DMCNET communication, and the digital inputs should be used for Emergency Stop, Forward / Reverse Inhibit limit and Reference "Home" sensor only

<sup>4</sup> TN system: A power distribution system having one point directly earthed, the exposed conductive parts of the installation being connected to that point by protective earth conductor

# ASDA-B2-F DMCNET Servo Drive Specifications



ASDA-B2 Series		100 W	200 W	400 W	750 W	1 kW	1.5 kW	2 kW	3 kW
		01	02	04	07	10	15	20	30
Power Supply	Phase / Voltage	Three-phase 170 ~ 255 V <sub>AC</sub> , 50/60 Hz ±5%						Three-phase 170 ~ 255 V <sub>AC</sub> , 50/60 Hz ±5%	
		Single-phase 200 ~ 255 V <sub>AC</sub> , 50/60 Hz ±5%							
	Input Current (3PH) (Units: Arms)	0.7	1.11	1.86	3.66	4.68	5.9	8.76	9.83
	Input Current (1PH) (Units: Arms)	0.9	1.92	3.22	6.78	8.88	10.3	-	-
	Continuous Output Current (Units: Arms)	0.9	1.55	2.6	5.1	7.3	8.3	13.4	19.4
Cooling System		Natural Air Circulation				Fan Cooling			
Encoder Resolution		17-bit (160,000 p/rev)							
Main Circuit Control		SVPWM (Space Vector Pulse Width Modulation) Control							
Control Mode		Auto / Manual							
Regenerative Resistor		None		Built-in					
Position Control Mode	Max. Input Pulse Frequency	Transmitted by differential: 500 K (low speed) / 4 Mpps (high-speed) Transmitted by open-collector: 200 Kpps							
	Pulse Type	Pulse + Direction, A phase + B phase, CCW pulse + CW pulse							
	Command Source	External pulse							
	Smoothing Strategy	Low-pass filter							
	E-gear Ratio	Electronic gear N/M multiple N: 1 ~ (2 <sup>26</sup> - 1) / M: 1 ~ (2 <sup>31</sup> - 1) (1/50 < N/M < 25600)							
	Torque Limit Operation	Set by parameters							
	Feed Forward Compensation	Set by parameters							

ASDA-B2 Series		100 W	200 W	400 W	750 W	1 kW	1.5 kW	2 kW	3 kW
		01	02	04	07	10	15	20	30
Speed Control Mode	Analog Input Command	Voltage Range	0 ~ ±10V <sub>DC</sub>						
		Input Resistance	10KΩ						
		Time Constant	2.2 μs						
	Speed Control Range <sup>*1</sup>	1 : 5000							
	Command Source	External analog signal / Internal parameters							
	Smoothing Strategy	Low-pass and S-curve filter							
	Torque Limit	Set by parameters or via analog input							
	Bandwidth	Max. 550Hz							
	Speed Accuracy <sup>*2</sup>	±0.01% at 0 ~ 100% load fluctuation							
	±0.01% at ±10% power fluctuation								
	±0.01% at 0 °C ~ 50 °C ambient temperature fluctuation								
Torque Control Mode	Analog Input Command	Voltage Range	0 ~ ±10V <sub>DC</sub>						
		Input Resistance	10KΩ						
		Time Constant	2.2 μs						
	Command Source	External analog signal / Internal parameters							
	Smoothing Strategy	Low-pass filter							
Speed Limit	Set by parameters or via analog input								
Analog Monitor Output		Monitor signal can set by parameters (Output voltage range: ±8V)							
Digital Input / Output	Input	Servo on, Fault reset, Gain switch, Pulse clear, Zero clamp, Command input reverse control, Torque limit, Speed limit, Speed command selection, Speed/position mode switching, Speed/torque mode switching, Torque/position mode switching, Emergency stop, Positive/negative limit, Forward/reverse operation torque limit, Forward/reverse JOG input, E-gear N selection, Pulse input prohibition							
	Output	Encoder signal output (A, B, Z Line Driver / Z Open collector)							
Protective Functions		Servo on, Servo ready, Zero speed, Target speed reached, Target position reached, Torque limiting, Servo alarm, Brake control, Early warning for overload, Servo warning							
Protective Functions		Over current, Overvoltage, Under voltage, Overheat, Excessive speed deviation, Excessive position deviation, Encoder error, Emergency stop, Communication error, Short-circuit protection of terminal U, V, W and CN1, CN2, CN3							
Communication Interface		RS-232 / RS-485							
Environment	Installation Site	Indoor location (avoid direct sunlight), no corrosive liquid and gas (avoid oil mist, flammable gas, dust)							
	Altitude	Altitude 1000m or lower above sea level							
	Atmospheric Pressure	86 kPa ~ 106 kPa							
	Operating Temperature	0 °C ~ 55 °C (If operating temperature is above 45 °C, forced cooling will be required)							
	Storage Temperature	-20 °C ~ 65 °C (-4 °F ~ 149 °F)							
	Humidity	0 to 90% (non-condensing)							
	Vibration	Under 20Hz, 9.80665 m/s <sup>2</sup> (1G), 20 ~ 50 Hz 5.88 m/s <sup>2</sup> (0.6 G)							
	IP Rating	IP20							
	Power System	TN System <sup>*3</sup>							
Certifications	IEC/EN 61800-5-1    								

\*1. When it is in rated load, the speed ratio is: the minimum speed (smooth operation) / rated speed

\*2. When the command is the rated speed, the velocity correction ratio is: (rotational speed with no load - rotational speed with full load) / rated speed



\*3. TN system: The neutral point of the power system connects to the ground directly. The exposed metal components connect to the ground via the protective earth conductor

# ASDA-M DMCNET Servo Drive Specifications



ASDA-M Series		750W	1.5 kW
		07	15
Power Supply	Phase / Voltage	Three-Phase or Single-Phase 220 V <sub>AC</sub>	
	Permissible Voltage Range	Three-Phase or Single-Phase 200~230 V <sub>AC</sub> , -15% ~ 10%	
	Input Current (3PH) (Units: Arms)	9.3	18.6
	Input Current (1PH) (Units: Arms)	17.8	33.3
	Continuous Output Current	5.1	8.3
Cooling System		Fan Cooling	
Encoder Resolution / Feedback Resolution		20-bit (1280000 p/rev)	
Control of Main Circuit		SVPWM (Space Vector Pulse Width Modulation) Control	
Tuning Modes		Auto / Manual	
Regenerative Resistor		None	
Position Control Mode	Max. Input Pulse Frequency	Max. 500Kpps / 4Mpps (Line driver) Max. 200Kpps (Open collector)	
	Pulse Type	Pulse + Direction, A phase + B phase, CCW pulse + CW pulse	
	Command Source	External pulse train (Pt mode) / Internal procedures (Pr mode)	
	Smoothing Strategy	Low-pass and P-curve filter	
	Electronic Gear	Electronic gear N/M multiple N: 1~32767, M: 1:32767 (1/50 < N/M < 25600)	
	Torque Limit Operation	Set by parameters	
	Feed Forward Compensation	Set by parameters	
Speed Control Mode	Analog Input Command	Voltage Range	0 ~ ±10 V <sub>DC</sub>
		Input Resistance	10 KΩ
		Time Constant	2.2 μs
	Speed Control Range <sup>1</sup>	1 : 5000	
	Command Source	External analog signal / Internal parameters	
	Smoothing Strategy	Low-pass and S-curve filter	
	Torque Limit Operation	Set by parameters or via analog input	
	Frequency Response Characteristic	Max. 1 kHz	
Speed Accuracy <sup>2</sup> (at rated rotation speed)	0.01% or less at 0 ~ 100% load fluctuation		
	0.01% or less at ±10% power fluctuation		
		0.01% or less at 0°C ~ 50°C ambient temperature fluctuation	



ASDA-M Series			750 W	1.5 kW
			07	15
Torque Control Mode	Analog Input Command	Voltage Range	0 ~ ±10V <sub>dc</sub>	
		Input Resistance	10KΩ	
		Time Constant	2.2μs	
	Command Source	External analog signal / Internal parameters		
	Smoothing Strategy	Low-pass filter		
Speed Limit Operation	Set by parameters or via analog input			
Analog Monitor Output			Monitor signal can be set by parameters (Output voltage range: ±8V)	
Digital Inputs/Outputs	Inputs	Servo On, Reset, Gain switching, Pulse clear, Zero speed CLAMP, Command input reverse control, Command triggered, Speed/Torque limit enabled, Position command selection, Motor stop, Speed Position Selection, Position / Speed mode switching, Speed / Torque mode switching, Torque / Position mode switching, Pt / Pr command switching, Emergency stop, Forward / Reverse inhibit limit, Reference "Home" sensor, Forward / Reverse operation torque limit, Move to "Home", Electronic cam, Forward / Reverse JOG input, Event trigger Pr command, Electronic gear ratio (Numerator) selection and Pulse inhibit input		
	Outputs	Encoder signal output (A, B, Z Line Driver and Z Open Collector ) Servo ready, Servo On, At Zero speed, At Speed reached, At Positioning completed, At Torques limit, Servo alarm (Servo fault) activated, Electromagnetic brake control, Homing completed, Output overload warning, Servo warning activated, Position command overflow, Forward / Reverse software limit, Internal position command completed, Capture operation completed output, Motion control completed output, Master position of E-CAM (electronic CAM)		
Protective Functions			Overcurrent, Overvoltage, Undervoltage, Motor overheated, Regeneration error, Overload, Overspeed, Abnormal pulse control command, Excessive deviation, Encoder error, Adjustment error, Emergency stop activated, Reverse/ Forward limit switch error, Position excessive deviation of full-close control loop, Serial communication error, Input power phase loss, Serial communication time out, short circuit protection of U, V, W, and CN1, CN2, CN3 terminals	
Communication Interface			RS-232 / RS-485 / CANopen / USB	
Environment	Installation Site		Indoor location (avoid direct sunlight), no corrosive liquid and gas (avoid oil mist, flammable gas, dust)	
	Altitude		Altitude 1000m or lower above sea level	
	Atmospheric pressure		86 kPa ~ 106 kPa	
	Operating Temperature		0°C ~ 55°C (If operating temperature is above 45°C, forced cooling will be required)	
	Storage Temperature		-20°C ~ 65°C	
	Humidity		0 ~ 90% RH (non-condensing)	
	Vibration		20 Hz or below 9.80665 m/s <sup>2</sup> (1G), 20 ~ 50Hz 5.88 m/s <sup>2</sup> (0.6G)	
	IP Rating		IP20	
	Power System		TN System <sup>3</sup>	
Certifications			IEC/EN 61800-5-1, UL 508C   US LISTED	

\*1. Rated rotation speed: With a full load, speed ratio is defined as the minimum speed (the motor will not pause)

\*2. When command is rated rotation speed, the speed fluctuation rate is defined as: (Empty load rotation speed - Full load rotation speed) / Rated rotation speed

\*3. TN system: A power distribution system having one point directly earthed, the exposed conductive parts of the installation being connected to that point by a protective earth conductor

## Servo Drive and Servo Motor Combinations

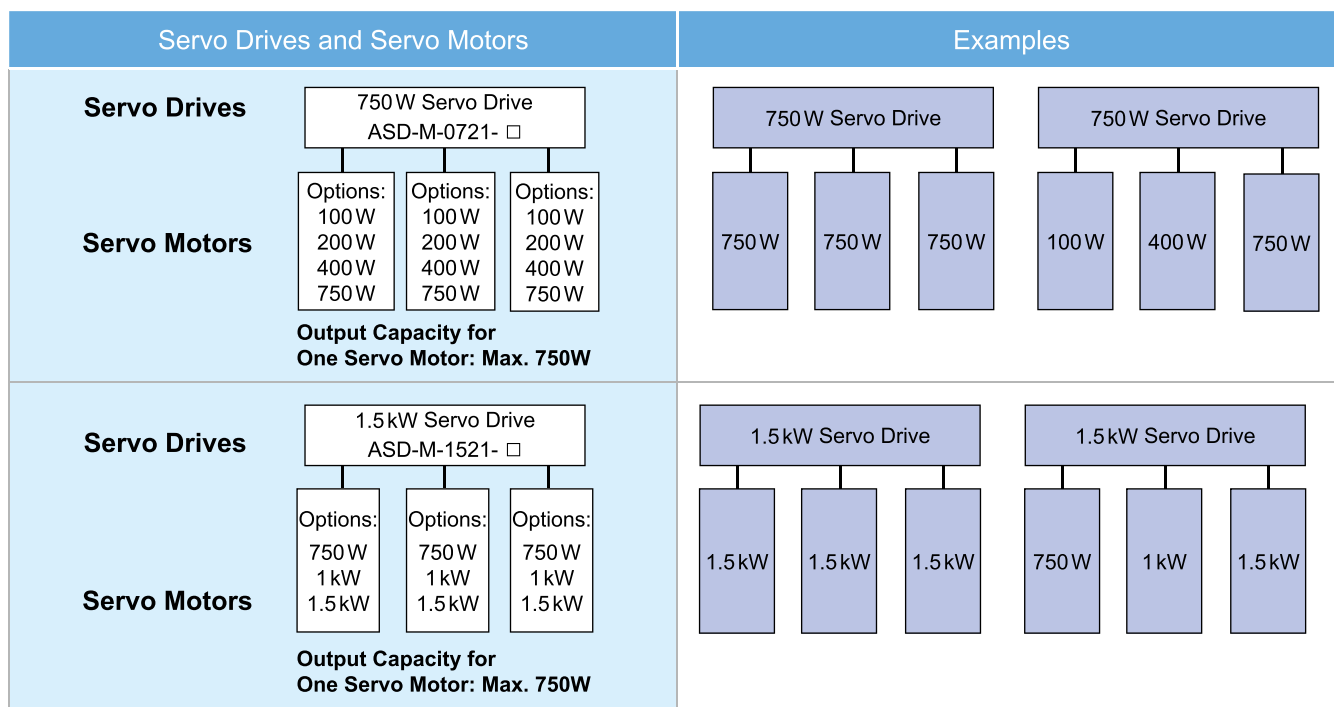

## General Signals of Connector CN1 (ASD-A3-F/ASD-A2-F/ASD-A2R-F/ASD-B2-F)

Signals	PIN No.			Description
	A2-F	A2R-F	B2-F	
DI1	PIN 9	PIN 9	PIN 1	Digital Inputs (Positive / Negative limit, Original point, Emergency stop), available to be set to meet users' requirements
DI2	PIN 10	PIN 10	PIN 2	
DI3	PIN 34	PIN 34	PIN 3	
DI4	PIN 8	PIN 8	PIN 4	
DI5	PIN 33	PIN 33	PIN 5	
DI6	PIN 32	PIN 32		
DI7	PIN 31	PIN 31		
DI8	PIN 30	PIN 30		
<b>Numbers</b>	<b>8</b>	<b>8</b>	<b>5</b>	
DO1+	PIN 7	PIN 7	PIN 12	Digital Outputs (Brake control), available to be set to meet users' requirements
DO1-	PIN 6	PIN 6	PIN 13	
DO2+	PIN 5	PIN 5	PIN 14	
DO2-	PIN 4	PIN 4	PIN 15	
DO3+	PIN 3	PIN 3		
DO3-	PIN 2	PIN 2		
DO4+	PIN 1	PIN 1		
DO4-	PIN 26	PIN 26		
DO5+	PIN 28	PIN 28		
DO5-	PIN 27	PIN 27		
<b>Numbers</b>	<b>5</b>	<b>5</b>	<b>2</b>	
OA+	PIN 21	PIN 21	PIN 7	Encoder signal output A, B, Z (Line Driver output)
OA-	PIN 22	PIN 22	PIN 8	
OB+	PIN 25	PIN 25	PIN 9	
OB-	PIN 23	PIN 23	PIN 10	
OZ+	PIN 50	PIN 50		
OZ-	PIN 24	PIN 24		
GND	PIN 13	PIN 13	PIN 6	VCC voltage based on GND
COM+	PIN 11	PIN 11	PIN 11	Common input for Digital Input (DI) voltage (positive end: connect to COM+; negative end: connect to COM-)
VDD	PIN 17	PIN 17		VDD is the +24 V power provided by the drive and is for Digital Input (DI) and Digital Output (DO) signal (Max. current: 500mA)
COM-	PIN 45、47、49	PIN 45、47、49		Common input for Digital Input (DI) voltage (positive end: connect to COM+; negative end: connect to COM-)
DI (Digital Input): Internal Power Supply (DC 24V)	Internal and External Power Supply	Internal and External Power Supply	External Power Supply Only	

# Connector CN6 for DMCNET Communication (ASD-A3-F/ASD-A2-F/ASD-A2R-F/ASD-B2-F/ASD-M)

CN6 communication connector adopts RJ45 joint and isolated cables for connecting Delta's motion control card directly to perform position, speed and torque control on the servo drives and monitor their status.

- Station numbers of DMCNET communication: same as RS-232 and RS-485; set by parameter P3-00 with transmission speed up to 20Mbps
- Provides two communication ports for transmission and receiving, convenient for direct connection of more than one servo drive in serial (connecting 120Ω termination resistor to the last servo drive needed)



Connector CN6 (female)

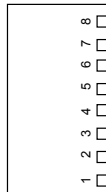
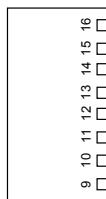

PIN No.	Signal Name	Description
1, 9	DMCNET_1A	DMCNET Channel 1 bus line (+)
2, 10	DMCNET_1B	DMCNET Channel 1 bus line (-)
3, 11	DMCNET_2A	DMCNET Channel 2 bus line (+)
4, 12	-	Reserved
5, 13	-	Reserved
6, 14	DMCNET_2B	DMCNET Channel 2 bus line (-)
7, 15	-	Reserved
8, 16	-	Reserved

※ Connecting method of termination resistor: Two 120Ω termination resistors are required. One is connected between DMCNET\_1A and DMCNET\_1B and the other is connected between DMCNET\_2A and DMCNET\_2B

## Monitoring Signals

ASDA-A2 or ASDA-B2



OA, /OA, OB, /OB

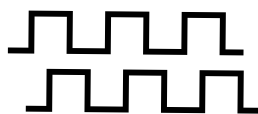

# EtherCAT Remote Modules

## Gateway Type E-bus Remote Power Coupler

R1-EC5500D0 / R1-EC5512D0

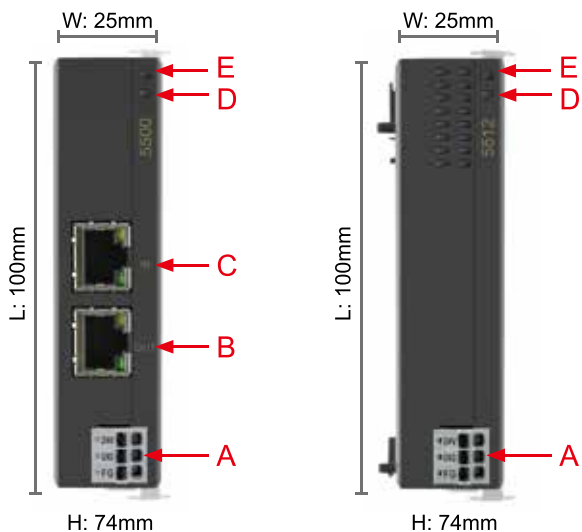

NO.	Description
A.	DC Power Input
B.	EtherCAT Output
C.	EtherCAT Input
D.	Status Indicator
E.	Power Indicator

Technical Data	R1-EC5500D0	R1-EC5512D0
Task Within EtherCAT System	Connect EtherCAT Slave module with 100 baseTX EtherCAT	
Data Transfer Medium	Ethernet/EtherCAT cable (min. CAT 5), shielded	-
Distance Between Stations	100 M (100BASE-TX) between two slaves	-
Protocol	EtherCAT	
Data Transfer Rates	100 Mbaud	
Bus Interface	RJ 45 x 2	-
Input Voltage	24 V <sub>DC</sub>	
Input Current	50 mA + (E-bus total E-bus current)/4	
Current Supply E-Bus	2A	
Electrical Isolation	500 Vrms (Power contact/Supply voltage/Ethernet)	
Vibration/Shock Resistance	EN 60068-2-6/EN 60068-2-27/29	
EMC Immunity	ESD (IEC 61131-2, IEC 61000-4-2): 8KV Air Discharge EFT (IEC 61131-2, IEC 61000-4-4): Power Line: 2KV Communication I/O: 1KV RS (IEC 61131-2, IEC 61000-4-3): 80MHz ~ 1GHz, 10V/m	
Operating Environment	Operating temperature: 0°C ~ 50°C Storage temperature: -20°C ~ 70°C	
Weight	55 g	
Protection Class	IP20	
Mounting Type	DIN-rail	

# 1-Channel Pulse Output Remote Module

R1-EC5621D0

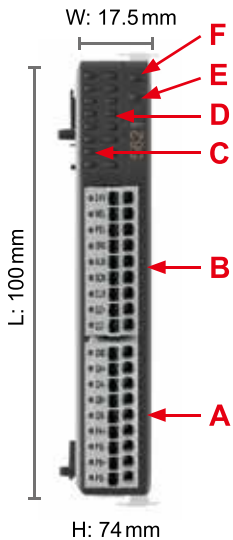

NO.	Description	No.	Description
A.	IO Signal Port	D.	IO Signal Indicator
B.	IO Signal Port	E.	Status Indicator
C.	IO Signal Indicator	F.	Power Indicator

Input	Description	Input	Description
24V	24V Power	GND	External Ground
MEL	End Limit (-)	QA+	Encoder A Phase (+)
PEL	End Limit (+)	QA-	Encoder A Phase (-)
ORG	Home Signal	QB+	Encoder B Phase (+)
ALM	Servo Alarm	QB-	Encoder B Phase (-)
SON	Servo On	PA+	Pulse Signal (+)
CLR	Reset Servo Alarm	PA-	Pulse Signal (-)
QZ+	Encoder Z Phase (+)	PB+	Dir. Signal (+)
QZ-	Encoder Z Phase (-)	PB-	Dir. Signal (-)

Technical Data	R1-EC5621D0
Number of Outputs	1 channel ( PA+, PA-, PB+, PB- )
Number of Inputs	1 channel (QA+, QA-, QB+, QB-, QZ+, QZ-)
Power Supply	Supplied by E-bus
Signal Voltage	RS422 Level
Max. Output Current	RS422 specification
Base Frequency	1Hz ~ 4MHz
Numbers of 24V Input	4 ( MEL, PEL, ORG, ALM)
Numbers of 24V Output	2 ( CLR, SON)
Trigger Voltage (On > Off)	< 8V <sub>DC</sub>
Trigger Voltage (Off > On)	> 16.5V <sub>DC</sub>
Maximum Current of Each Output Port	30mA
Current Consumption E-Bus	150mA
Electrical Isolation	500 Vrms (E-bus / field potential)
Bit Width in the Process Image	32 byte in/out (1 x 16 byte data, 1 x 16 byte control/status)
Vibration / Shock Resistance	EN 60068-2-6 / EN 60068-2-27 / 29
EMC Immunity	ESD (IEC 61131-2, IEC 61000-4-2): 8 KV Air Discharge EFT (IEC 61131-2, IEC 61000-4-4): Power Line: 2KV Communication I/O: 1KV RS (IEC 61131-2, IEC 61000-4-3: 8MHz ~ 1GHz, 10V/m)
Operating Environment	Operating temperature: 0°C ~ 50°C Storage temperature: -20°C ~ 70°C
Weight	Approx. 60 g
Protection Class	IP20
Mounting Type	DIN-rail

# EtherCAT Remote Modules

## 16-Channel Input Remote Module

R1-EC6002D0 / R1-EC6022D0

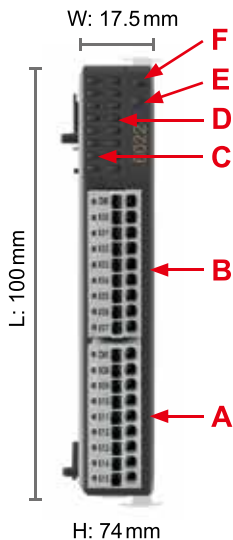

NO	Description	NO.	Description
A.	Port 1 Terminals	D.	Port 1 IO Signal X08~X15 (From the top)
B.	Port 0 Terminals	E.	Status Indicator
C.	Port 0 IO Signal X00~X07 (From the top)	F.	Power Indicator

Input	Description	Input	Description
CM0	Port 0 COM	CM1	Port1 COM
X00	Input 0	X08	Input 8
X01	Input 1	X09	Input 9
X02	Input 2	X10	Input 10
X03	Input 3	X11	Input 11
X04	Input 4	X12	Input 12
X05	Input 5	X13	Input 13
X06	Input 6	X14	Input 14
X07	Input 7	X15	Input 15

Technical Data	R1-EC6002D0	R1-EC6022D0
Connection Technology	single-ended	
Number of Inputs	16	
Nominal Voltage	24 V <sub>DC</sub> ± 10%	
Signal Type	SINK / SOURCE	
Trigger Voltage (On > Off)	< 8 V <sub>DC</sub>	
Trigger Voltage (Off > On)	> 16.5 V <sub>DC</sub>	
Input Filter	100µs	2ms
Input Current	3 mA at each port	
Current Consumption E-Bus	110 mA	
Electrical Isolation	500 V <sub>rms</sub> (E-bus/field potential)	
Bit Width in the Process Image	16 inputs	
Vibration/Shock Resistance	EN 60068-2-6/EN 60068-2-27/29	
EMC Immunity	ESD (IEC 61131-2, IEC 61000-4-2): 8 KV Air Discharge EFT (IEC 61131-2, IEC 61000-4-4): Power Line: 2KV Communication I/O: 1KV RS (IEC 61131-2, IEC 61000-4-3): 80 MHz ~ 1 GHz, 10V/m	
Operating Environment	Operating temperature: 0°C ~ 50°C Storage temperature: -20°C ~ 70°C	
Weight	55 g	
Protection Class	IP20	
Mounting Type	DIN-rail	

## 16-Channel Output Remote Module

R1-EC7062D0 / R1-EC70E2D0 / R1-EC70A2D0 / R1-EC70F2D0

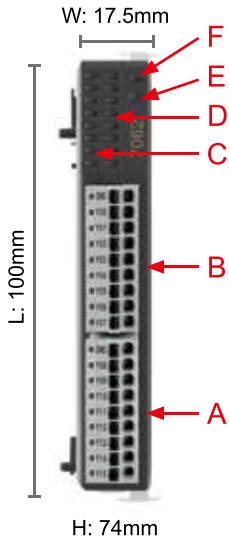

NO.	Description	NO.	Description
A.	Port 1 Terminals	D.	Port 1 IO Signal Y08~Y15 (From the top)
B.	Port 0 Terminals	E.	Status Indicator
C.	Port 0 IO Signal Y00~Y07 (From the top )	F.	Power Indicator

Output	Description	Output	Description
GND*	Port 0 GND	GND	Port 1 GND
24V**	Port 0 24V Input		
Y00	Input 0	Y08	Input 8
Y01	Input 1	Y09	Input 9
Y02	Input 2	Y10	Input 10
Y03	Input 3	Y11	Input 11
Y04	Input 4	Y12	Input 12
Y05	Input 5	Y13	Input 13
Y06	Input 6	Y14	Input 14
Y07	Input 7	Y15	Input 15

\* R1-EC7062D0 / R1-EC70E2D0

\*\* R1-EC70A2D0 / R1-EC70F2D0

Technical Data	R1-EC7062D0	R1-EC70E2D0	R1-EC70A2D0	R1-EC70F2D0
Connection Technology	MOSFET			
Signal Type	SINK		SOURCE	
Nominal Voltage	24 V <sub>DC</sub>			
Maintains Output	X	✓	X	✓
Input Current	0.5A (Max.)	0.25A (Max.)		
Current Consumption E-Bus	120mA	200mA		
Response Time / Frequency	1 KHz			
Trigger Time (OFF > ON)	140us		160us	
Trigger Time (ON > OFF)	150us		110us	
EMC Immunity	ESD (IEC 61131-2, IEC 61000-4-2): 8 KV Air Discharge EFT (IEC 61131-2, IEC 61000-4-4): Power Line: 2 KV Communication I/O: 1 KV RS (IEC 61131-2, IEC 61000-4-3): 80 MHz ~ 1 GHz, 10 V/m			
Operating Environment	Operating temperature: 0°C ~ 50°C Storage temperature : -20°C ~ 70°C			
Weight	Approx. 60 g			
Protection Class	IP20			
Mounting Type	DIN-rail			

# EtherCAT Remote Modules

## 4-Channel Analog Input Remote Module

### R1-EC8124D0

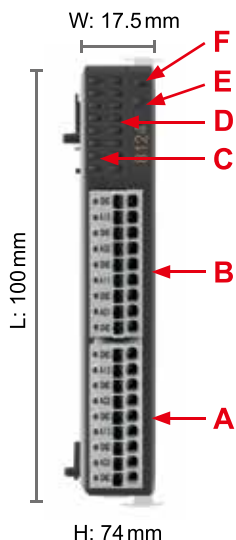

NO.	Description	NO.	Description
A.	CH3/CH4 Signal port	D.	CH3/CH4 Signal Indicator
B.	CH1/CH2 Signal port	E.	Status Indicator
C.	CH1 Voltage / Current Input	F.	Power Indicator

Input	Description	Input	Description
GND	Analog Ground	GND	Analog Ground
AI0	CH1 Voltage /Current Input	AI2	CH3 Voltage / Current Input
GND	Analog Ground	GND	Analog Ground
AG0	CH1 Current COM*	AG2	CH3 Current COM*
GND	Analog Ground	GND	Analog Ground
AI1	CH2 Voltage / Current Input	AI3	CH4 Voltage / Current Input
GND	Analog Ground	GND	Analog Ground
AG1	CH2 Current COM*	AG3	CH4 Current COM*
GND	Analog Ground	GND	Analog Ground

\* In current mode: please connect current COM to GND ; In voltage mode: please disconnect this COM

Technical data	R1-EC8124D0
Number of Inputs	4 (single-ended)
Power Supply	via the E-bus
Signal Voltage	$\pm 10V / \pm 5V$
Internal Resistance	$> 1 M\Omega$
Input Filter Limit Frequency	1 KHz ~ 10 KHz
Resolution	16 bit
Over Sampling Rate	0 ~ 64
Conversion Time	2 us ~ 191 us (depends on Over Sampling Rate)
Measuring Error	$< \pm 0.2\%$ (relative to full scale value)
Electrical Isolation	500 Vrms (E-bus / signal voltage)
Current Consumption E-Bus	300 mA
Bit Width in the Process Image	input : 4 x 16 byte data, 4 x 16 byte control/status
Vibration/Shock Resistance	60068-2-6/EN 60068-2-27/29
EMC Immunity	ESD (IEC 61131-2, IEC 61000-4-2): 8 KV Air Discharge EFT (IEC 61131-2, IEC 61000-4-4): Power Line: 2KV Communication I/O: 1KV RS (IEC 61131-2, IEC 61000-4-3): 8 MHz ~ 1 GHz, 10V/m
Operating Environment	Operating temperature: 0°C ~ 50°C Storage temperature: -20°C ~ 70°C
Weight	Approx. 60 g
Protection Class	IP20
Mounting Type	DIN-rail



## 4-Channel Analog Output Remote Module

### R1-EC9144D0

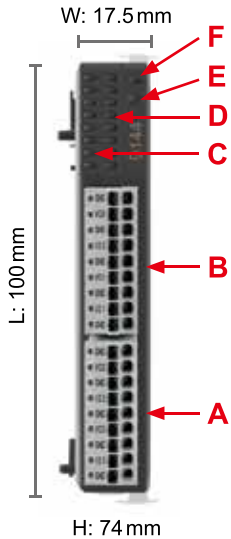

NO.	Description	NO.	Description
A.	CH3/CH4 Signal Port	D.	CH3/CH4 Signal Indicator
B.	CH1/CH2 Signal Port	E.	Status Indicator
C.	CH1/CH2 Signal Indicator	F.	Power Indicator

Output	Description	Output	Description
GND	Analog Ground	GND	Analog Ground
VO0	CH1 Voltage Output	VO2	CH3 Voltage Output
GND	Analog Ground	GND	Analog Ground
IO0	CH1 Current Output	IO2	CH3 Current Output
GND	Analog Ground	GND	Analog Ground
VO1	CH2 Voltage Output	VO3	CH4 Voltage Output
GND	Analog Ground	GND	Analog Ground
IO1	CH2 Current Output	IO3	CH4 Current Output
GND	Analog Ground	GND	Analog Ground

Technical Data	R1-EC9144D0
Number of Inputs	4 (single-ended)
Power Supply	via the E-bus
Signal Voltage Output	$\pm 10V / \pm 5V / 0 \sim 5V / 0 \sim 10V$
Current Output	$0 \sim 20\text{ mA} / 4 \sim 24\text{ mA} / 0 \sim 24\text{ mA}$
Load	$> 1\text{ K}\Omega$ (short-circuit-proof)
Resolution	16 bit
Conversion Time	80 us
Measuring Error	$< \pm 0.2\%$ (relative to full scale value) voltage output $< \pm 0.3\%$ (relative to full scale value) current output
Electrical Isolation	1000 Vrms (E-bus/signal voltage)
Current Consumption E-Bus	550 mA
Bit Width in the Process Image	Output: 4 x 16 byte, (4 x 16-bit analog output)
Vibration / Shock Resistance	EN 60068-2-6/EN 60068-2-27/29
EMC Immunity	ESD (IEC 61131-2, IEC 61000-4-2): 8KV Air Discharge EFT (IEC 61131-2, IEC 61000-4-4): Power Line: 2KV Communication I/O: 1KV RS (IEC 61131-2, EC 61000-4-3): 8MHz ~ 1GHz, 10V/m
Operating Environment	Operating temperature: $0^\circ\text{C} \sim 50^\circ\text{C}$ Storage temperature: $-20^\circ\text{C} \sim 70^\circ\text{C}$
Weight	Approx. 60 g
Protection Class	IP20
Mounting Type	DIN-rail

# EtherCAT Remote Modules

## Manual Pulse Generator (MPG) Module

R1-EC5614D0

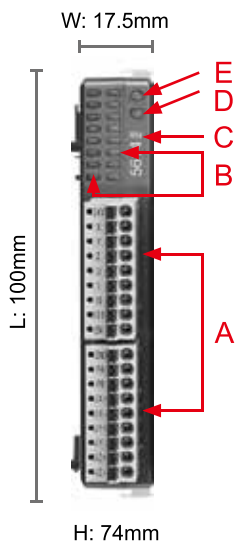

NO.	Description	NO.	Description
A.	IO Signal Port	D.	Status Indicator
B.	IO Signal Indicator	E.	Power Indicator
C.	Product No.		



Input	Description	Input	Description
<b>GND</b>	External Ground	<b>24V</b>	External Power Input
<b>PA</b>	MPG Pulse Phase A Input	<b>X</b>	X-axis Pulse Chosen Signal
<b>PB</b>	MPG Pulse Phase B Input	<b>Y</b>	Y-axis Pulse Chosen Signal
<b>JX+</b>	JOG X-axis Signal (+)	<b>Z</b>	Z-axis Pulse Chosen Signal
<b>JX-</b>	JOG X-axis Signal (-)	<b>U</b>	U-axis Pulse Chosen Signal
<b>JY+</b>	JOG Y-axis Signal (+)	<b>1</b>	Pulse magnification (x 1)
<b>JY-</b>	JOG Y-axis Signal (-)	<b>10</b>	Pulse magnification (x 10)
<b>JZ+</b>	JOG Z-axis Signal (+) / *W-axis	<b>100</b>	Pulse magnification (x 100)
<b>JZ-</b>	JOG Z-axis Signal (-) / *V-axis	<b>EN</b>	Motion / Setting Execution

\*Supports 6-axis MPG via software: JZ+ needs to connect to W-axis signal; JZ- needs to connect to V-axis signal

Technical Data	R1-EC5614
Control Axes	4 / 6 axes
Power Supply	via the E-bus
Pulse Magnification	x 1 / x 10 / x 100
JOG Input	3 / 2 sets
Sampling Rate	40KHz
FIFO Length	30 sets
Communication Time	125us - 3276800us
Trigger Time (ON > OFF)	< 8V <sub>DC</sub>
Trigger Time (OFF > ON)	> 16.5V <sub>DC</sub>
Current Consumption E-Bus	180mA
Electrical Isolation	500 Vrms (E-BUS / Signal Power)
Vibration / Shock Resistance	conforms to EN 60068-2-6 / EN 60068-2-27 / 29
EMC Immunity	ESD (IEC 61131-2, IEC 61000-4-2) EFT (IEC 61131-2, IEC 61000-4-4) RS (IEC 61131-2, EC 61000-4-3)
Operating Environment	Operating temperature: 0 °C ~ 50 °C Storage temperature: -20 °C ~ 70 °C
Weight	Approx. 55 g
Protection Class	IP20
Safety Certification	<b>CE</b>
Mounting Type	DIN-rail

# ASDA-A2-E EtherCAT Servo Drive Specifications

## 220V Series

ASDA A2-E Series		100 W	200 W	400 W	750 W	1 kW	1.5 kW	2 kW	3 kW	
		01	02	04	07	10	15	20	30	
Power Supply	Phase / Voltage	Three-phase / Single-phase 220V <sub>AC</sub>						Three-phase 220V <sub>AC</sub>		
	Permissible Voltage Range	Three-phase / Single-phase 200 ~ 230V <sub>AC</sub> , -15% ~ 10%						Three-phase 200 ~ 230V <sub>AC</sub> , -15% ~ 10%		
Input Current (3PH) Unit: Arms		0.39	1.11	1.86	3.66	4.68	5.9	8.76	9.83	
Input Current (1PH) Unit: Arms		0.69	1.92	3.22	6.78	8.88	10.3	-	-	
Continuous Output Current Unit: Arms		0.9	1.55	2.6	5.1	7.3	8.3	13.4	19.4	
Cooling Method		Natural Air Circulation				Fan Cooling				
Encoder Resolution (Servo Drive Resolution)		Incremental type: 20-bit (1280000 p/rev) ; Absolute type: 17-bit								
Control of Main Circuit		SVPWM (Space Vector Pulse Width Modulation) Control								
Tuning Modes		Auto / Manual								
Dynamic Brake		Built-in								
Position Control Mode (CSP)	Command Source	External analog signal								
	Smoothing Strategy	Low-pass and P-curve filter								
	Electronic Gear	Electronic gear N/M multiple N: 1 ~ 32767, M: 1 : 32767 (1/50 < N/M < 25600)								
	Torque Limit Operation	External analog signal								
Feed Forward Compensation		External analog signal / Internal parameters								
Speed Control Mode (CSV)	Speed Control Range <sup>*1</sup>	1 : 5000						1 : 3000		
	Command Source	External analog signal								
	External Analog Signal	External analog signal								
	Smoothing Strategy	Low-pass and S-curve filter								
	Torque Limit Operation	Set by parameters or via analog input								
	Frequency Response Characteristic	Max. 1 kHz								
	Speed Accuracy (at rated rotation speed) <sup>*2</sup>	0.01% or less at 0 ~ 100% load fluctuation 0.01% or less at 0°C ~ 50°C ambient temperature fluctuation								
Feed Forward Compensation		0.01% or less at ±10% power fluctuation								
Torque Control Mode (CST)	Command Source	External analog signal								
	Smoothing Strategy	Low-pass filter								
	Speed Limit Operation	Via analog input								
Digital Inputs/Outputs	Inputs	Servo on, Reset, Gain switching, Pulse clear, Zero speed CLAMP, Command input reverse control, Command triggered, Speed/Torque limit enabled, Position command selection, Motor stop, Speed position selection, Position / Speed mode switching, Speed / Torque mode switching, Torque / Position mode switching, PT / PR command switching, Emergency stop, Forward / Reverse inhibit limit, Reference "Home" sensor, Forward / Reverse operation torque limit, Move to "Home" , Electronic Cam (E-Cam), Forward / Reverse JOG input, Event trigger PR command, Electronic gear ratio (Numerator) selection and Pulse inhibit input								
	Outputs	Encoder signal output (A, B, Z Line Driver and Z Open Collector ) Servo ready, Servo on, At Zero speed, At Speed reached, At Positioning completed, At Torques limit, Servo alarm (Servo fault) activated, Electromagnetic brake control, Homing completed, Output overload warning, Servo warning activated, Position command overflow, Forward / Reverse software limit, Internal position command completed, Capture operation completed output., Motion control completed output., Master position of E-Cam (Electronic Cam)								
Protective Functions		Overcurrent, Overvoltage, Undervoltage, Motor overheated, Regeneration error, Overload, Overspeed, Abnormal pulse control command, Excessive deviation, Encoder error, Adjustment error, Emergency stop activated, Reverse/ Forward limit switch error, Position excessive deviation of full-close control loop, Serial communication error, Input power phase loss, Serial communication time out, short circuit protection of U, V, W, and CN1, CN2, CN3 terminals								
Communication Interface		USB / EtherCAT								
Environment	Installation Site	Indoor location (avoid direct sunlight), no corrosive liquid and gas (avoid oil mist, flammable gas, dust)								
	Altitude	Altitude 1000 m or lower above sea level								
	Atmospheric Pressure	86kPa ~ 106kPa								
	Operating Temperature	0°C ~ 55°C (If operating temperature is above 45°C, forced cooling will be required)								
	Storage Temperature	-20°C ~ 65°C (-4°F ~ 149°F)								
	Humidity	0 ~ 90% RH (non-condensing)								
	Vibration	9.80665 m/s <sup>2</sup> (1 G) less than 20 Hz, 5.88 m/s <sup>2</sup> (0.6 G) 20 ~ 50 Hz								
	IP Rating	IP20								
	Power System	TN System <sup>*3</sup> IEC/EN 61800-5-1, UL 508C, C-tick								
Certifications		  								

\*1 Rated rotation speed: When full load, speed ratio is defined as the minimum speed (the motor will not pause)

\*2 When command is rated rotation speed, the speed fluctuation rate is defined as: (Empty load rotation speed – Full load rotation speed) / Rated rotation speed

\*3 TN system: A power distribution system having one point directly earthed, the exposed conductive parts of the installation being connected to that point by a protective earth conductor

# ASDA-A2-E EtherCAT Servo Drive Specifications

## 400V Series

ASDA A2-E Series		400W	750W	1kW	1.5kW	2kW	3kW	4.5kW	5.5kW	7.5kW	
		04	07	10	15	20	30	45	55	75	
Power Supply	Input Voltage	24V <sub>DC</sub> , ±10%									
	Input Current	0.43 A			1.18A			1.66A			
	Input Power	10.32W			28.2W			39.85W			
Main Circuit Power		Three-phase, 380 ~ 480 V <sub>AC</sub> , ±10%									
Input Current	Unit: Arms	1.40	2.35	3.02	4.24	5.65	8.01	11.9	14.1	17.27	
Continuous Output Current	Unit: Arms	2.0	3.35	3.52	5.02	6.66	11.9	20	22.37	30	
Cooling Method		Fan Cooling									
Encoder Resolution (Servo Drive Resolution)		Incremental type: 20-bit (1280000 p/rev) ; Absolute type: 17-bit									
Control of Main Circuit		SVPWM (Space Vector Pulse Width Modulation) Control									
Tuning Modes		Auto / Manual									
Dynamic Brake		Built-in									
Position Control Mode (CSP)	Command Source	External analog signal									
	Smoothing Strategy	Low-pass and P-curve filter									
	Electronic Gear	Electronic gear N/M multiple N: 1 ~ 32767, M: 1 : 32767 (1/50 < N/M < 25600)									
	Torque Limit Operation	External analog signal									
	Feed Forward Compensation	External analog signal / Internal parameters									
Speed Control Mode (CSV)	Speed Control Range <sup>*1</sup>	1 : 5000							1 : 3000		
	Command Source External Analog Signal	External analog signal									
	Smoothing Strategy	Low-pass and S-curve filter									
	Torque Limit Operation	Set by parameters or via analog input									
	Frequency Response Characteristic	Max. 1 kHz									
	Speed Accuracy (at rated rotation speed) <sup>*2</sup>	0.01% or less at 0 ~ 100% load fluctuation 0.01% or less at 0°C ~ 50°C ambient temperature fluctuation									
	Feed Forward Compensation	0.01% or less at ±10% power fluctuation									
Torque Control Mode (CST)	Command Source	External analog signal									
	Smoothing Strategy	Low-pass filter									
	Speed Limit Operation	Via analog input									
Digital Inputs/Outputs	Inputs	Servo on, Reset, Gain switching, Pulse clear, Zero speed CLAMP, Command input reverse control, Command triggered, Speed/Torque limit enabled, Position command selection, Motor stop, Speed position selection, Position / Speed mode switching, Speed / Torque mode switching, Torque / Position mode switching, PT / PR command switching, Emergency stop, Forward / Reverse inhibit limit, Reference "Home" sensor, Forward / Reverse operation torque limit, Move to "Home" , Electronic Cam (E-Cam), Forward / Reverse JOG input, Event trigger PR command, Electronic gear ratio (Numerator) selection and Pulse inhibit input									
	Outputs	Encoder signal output (A, B, Z Line Driver and Z Open Collector ) Servo ready, Servo on, At Zero speed, At Speed reached, At Positioning completed, At Torques limit, Servo alarm (Servo fault) activated, Electromagnetic brake control, Homing completed, Output overload warning, Servo warning activated, Position command overflow, Forward / Reverse software limit, Internal position command completed, Capture operation completed output., Motion control completed output., Master position of E-Cam (Electronic Cam)									
Protective Functions		Overcurrent, Overvoltage, Undervoltage, Motor overheated, Regeneration error, Overload, Overspeed, Abnormal pulse control command, Excessive deviation, Encoder error, Adjustment error, Emergency stop activated, Reverse/ Forward limit switch error, Position excessive deviation of full-close control loop, Serial communication error, Input power phase loss, Serial communication time out, short circuit protection of U, V, W, and CN1, CN2, CN3 terminals									
Communication Interface		USB / EtherCAT									
Environment	Installation Site	Indoor location (avoid direct sunlight), no corrosive liquid and gas (avoid oil mist, flammable gas, dust)									
	Altitude	Altitude 1000 m or lower above sea level									
	Atmospheric Pressure	86 kPa ~ 106 kPa									
	Operating Temperature	0°C ~ 55°C (If operating temperature is above 45°C, forced cooling will be required)									
	Storage Temperature	-20°C ~ 65°C (-4°F ~ 149°F)									
	Humidity	0 ~ 90% RH (non-condensing)									
	Vibration	9.80665 m/s <sup>2</sup> (1 G) less than 20 Hz, 5.88 m/s <sup>2</sup> (0.6 G) 20 ~ 50 Hz									
	IP Rating	IP20									
Power System	TN System <sup>*3</sup>										
Certifications	IEC/EN 61800-5-1, UL 508C, C-tick										



\*1 Rated rotation speed: When full load, speed ratio is defined as the minimum speed (the motor will not pause)

\*2 When command is rated rotation speed, the speed fluctuation rate is defined as: (Empty load rotation speed – Full load rotation speed) / Rated rotation speed

\*3 TN system: A power distribution system having one point directly earthed, the exposed conductive parts of the installation being connected to that point by a protective earth conductor

# Communication Specifications

<b>Physical Layer</b>	IEEE802.3u (100 BASE-TX)
<b>Data Link Layer</b>	APRD, FPRD, BRD, LRD, APWR, FPWR, BWR, LWR, ARMW, FRMW, APRW, FPRW, BRW, LRW
<b>Device Profile (CiA402)</b>	Homing Mode, Profile Position Mode, Profile Velocity Mode, Profile Torque Mode, Interpolated Position Mode, Cyclic Syn. Position Mode, Cyclic Syn. Velocity Mode, Cyclic Syn. Torque Mode, Touch Probe Function, Torque Limit Function
<b>Process Data Size</b>	Tx: 8 object (32 byte, Max.) Rx: 8 object (32 byte, Max.); Dynamic Mapping supported
<b>Bus Clock</b>	DC cycle with min. 250 us*
<b>LED Indicator</b>	EtherCAT Link/Activity Indicator (L/A) x 2 EtherCAT RUN Indicator (RUN) x 1 EtherCAT ERROR Indicator (ERR) x 1

\* This function will be available in a new version soon

## Accessories for ASDA-A2-E

<b>Part Number</b>	ASD-CN5C0026
<b>Description</b>	CN1 connector



<b>Part Number</b>	ASD-CNFS0808
<b>Description</b>	Pack of connectors used for STO wiring, 8 pcs of connectors in one pack



# Part Names and Functions

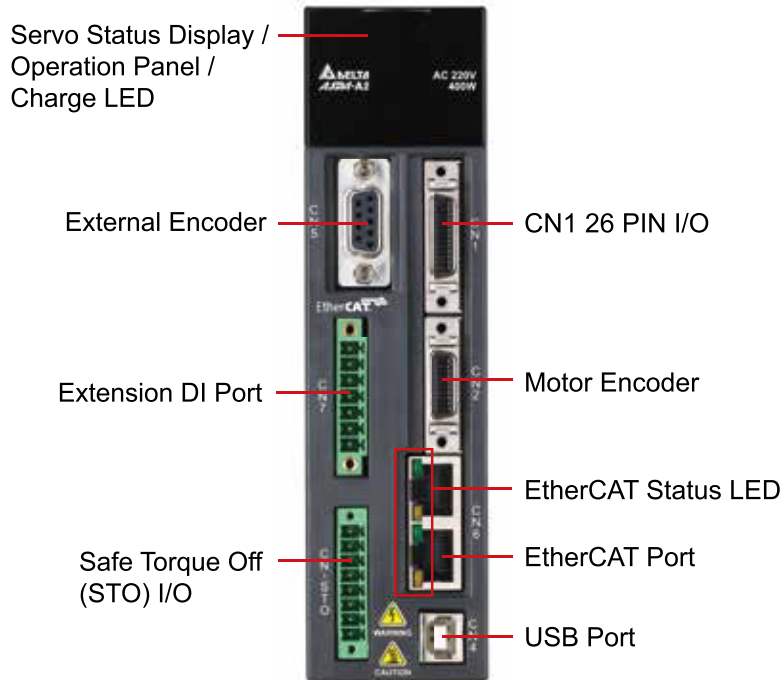

# Ordering Information

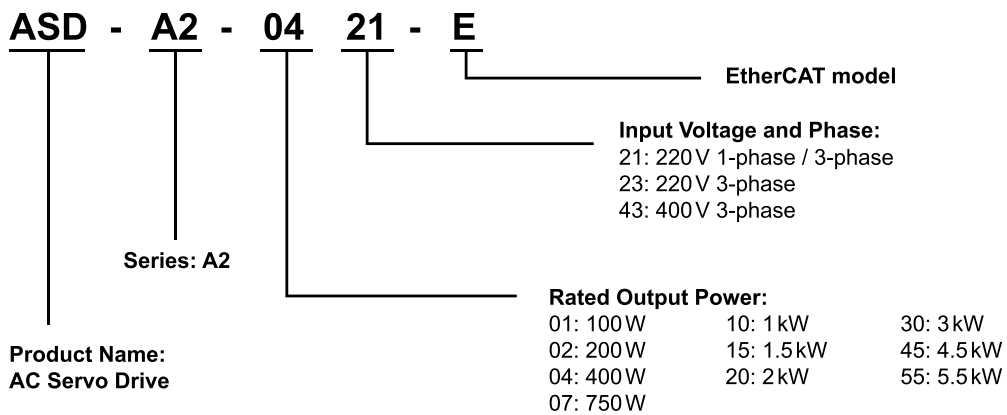

# Ordering Information

Programmable Automation Controllers - Motion Control Host PAC												
Model Name	CPU Type	Storage	Slot Interface	RAM	OS	Motion Protocol	Development Tool	Note				
MH1-A12D-A03DG	Atom E3845 Quad Core 1.91GHz	2 PCI	32GB CFast	4GB	Win 7 32bit	DMCNET	API					
MH1-A12D-A03DM			128GB SSD				IMP					
MH1-A12D-A05DG							API					
MH1-C50D-A03DG	Core i5-3610ME Dual Core 2.7GHz	2 PCI	32GB CFast	4GB	Win 7 32bit	DMCNET	API					
MH1-C50D-A03DM				8GB	Win 7 64bit		IMP					
MH1-C50D-A33DH			64GB SSD	4GB	Win 7 32bit		API					
MH1-C50D-A04DG					4GB		Win 7 32bit	API				
MH1-C50D-C03DG				PCIe (x4+x1)	32GB CFast			API				
MH1-C70D-A03DG	Core i7-3612QE Quad Core 2.1GHz	2 PCI	32GB CFast	4GB	Win 7 32bit	DMCNET	API					
MH1-C70D-A03DM				8GB	Win 7 64bit		IMP					
MH1-C70D-A33DH				PCIe (x4+x1)	4GB		Win 7 32bit	API				
MH1-C70D-C03DG							4GB	Win 7 64bit	API			
MH1-C70D-C33DH									API			
MH1-A12N-A03DG	Atom E3845 Quad Core 1.91GHz	2 PCI	32GB CFast	4GB	Win 7 32bit	NA	NA					
MH1-A12N-A05DG			128GB SSD									
MH1-C50N-A03DG	Core i5-3610ME Dual Core 2.7GHz	2 PCI	32GB CFast	4GB	Win 7 32bit	NA	NA					
MH1-C50N-A05DG			128GB SSD									
MH1-C50N-C03DG			PCIe (x4+x1)					32GB CFast	8GB	Win 7 64bit		
MH1-C50N-C33DH												
MH1-C70N-A03DG								2 PCI	32GB CFast	4GB	Win 7 32bit	NA
MH1-C70N-C03DG	PCIe (x4+x1)	8GB	Win 7 64bit									
MH1-C70N-C33DH												
MH2-P10N-N06DJ	Celeron J1900 Quad Core 2.4GHz	NA	32GB SSD	4GB	Win10 64bit	EtherCAT	API	2019 Q3 Available				
MH2-P10N-N06DL							IMP	2019 Q3 Available				
MH2-P10N-N06DN							CODESYS	2019 Q2 Available				
MH2-P10N-P06DN								2019 Q2 Available				

Programmable Automation Controllers - Motion Control Panel PC								
Model Name	CPU Type	Storage	Slot Interface	RAM	OS	Motion Protocol	Development Tool	Note
MP1-A10D-1012DG	Atom E3825 Dual Core 1.33GHz	10.1"	16GB SSD	2GB	Win 7 32bit	DMCNET	API	
MP1-A10D-1012DM							IMP	
MP1-A12D-1503DG	Atom E3845 Quad Core 1.91GHz	15"	32GB CFast	4GB	Win 7 32bit	DMCNET	API	
MP1-A12D-1503DM			128GB SSD				IMP	
MP1-A12D-1505DG								API
MP1-P10D-1505DJ	Celeron J1900 Quad Core 2.4GHz		128GB SSD		Win10 64bit		API	2019 Q3 Available
MP1-P10D-1505DL							IMP	2019 Q3 Available

# Ordering Information

Motion Control Cards	
PCI-DMC-A02	DMCNET Standard Type Motion Control Card with Local I/O (32 DI / 24 DO)
PCI-DMC-B01	DMCNET Advanced Type Motion Control Card with 2 Groups of Pulse Compare
PCI-DMC-B02	DMCNET Advanced Motion Control Card + 2D Pulse Compare
PCI-DMC-B03	DMCNET Advanced Motion Control Card + 3 Sets of Pulse Compare & 10 Sets of DO
PCI-DMC-F02	DMCNET Economic Type Motion Control Card + local IO (32 DI/24 DO)
PCIe-L221-B1D0	EtherCAT Advanced Motion Control Card + 2 Sets of Pulse Compare
PCI-L221-P1D0	EtherCAT Standard Type Motion Control Card
PCI-L221-B1D0	EtherCAT Advanced Type Motion Control Card with 2 Groups of Pulse Compare
PCI-M324-F1D0	4-axis Pulse Motion Control Card
PCI-D122-XND0	32IN/32OUT Digital Signal Capture Card
DB-D1XX-01D0	Digital Signal Capture Slave Card

DMCNET Remote Modules	
ASD-DMC-RM32MN	32 Digital Input Remote Module (NPN / PNP)
ASD-DMC-RM64MN	64 Digital Input Remote Module (NPN / PNP) plus MPG Module
ASD-DMC-RM32NT	32 Digital Output Remote Module
ASD-DMC-RM64NT	64 Digital Output Remote Module
ASD-DMC-RM32PT	32 Digital I/O Remote Module with 16 DI (NPN / PNP) & 16 DO (Transistor Output)
ASD-DMC-RM04PI	4-Channel Pulse Remote Module (4 Channels of 200 kHz Pulse Outputs and Inputs)
ASD-DMC-RM04AD	4-Channel Analog Input Module
ASD-DMC-RM04DA	4-Channel Analog Output Module
HMC-RIO3232RT5	Digital I/O Remote Module with 32 DI (NPN / PNP), 16 DO (Relay Output) & 16 DO (Transistor Output)

DMCNET Gateway Type Remote Modules	
ASD-DMC-GA01	DMCNET Gateway Type Remote Power Coupler
ASD-DMC-GE01PH	DMCNET Gateway Type Pulse Output Remote Module (1-Channel of 4M High-speed Pulse Interface)

EtherCAT Remote Modules	
R1-EC5500D0	E-BUS Remote Power Coupler
R1-EC5512D0	E-BUS Remote Power Coupler (Do not include communication network interface)
R1-EC5621D0	1-Channel Pulse Output Remote Module
R1-EC5614D0	MPG Extension Module
R1-EC6002D0	Digital Input Remote Module (NPN / PNP); response time 100us; response time < 0.1ms
R1-EC6022D0	Input Remote Module (NPN / PNP); response time 2ms
R1-EC7062D0	Digital Output Remote Module (NPN)
R1-EC70A2D0	Digital Output Remote Module (PNP)
R1-EC70E2D0	Digital Output Remote Module (NPN)
R1-EC70F2D0	Digital Output Remote Module (PNP)



### ASDA-A2-F DMCNET Servo Drives

ASD-A2-0121-F	A2 220 V 1-Phase/3-Phase 100W DMCNET Servo Drive
ASD-A2-0221-F	A2 220 V 1-Phase/3-Phase 200W DMCNET Servo Drive
ASD-A2-0421-F	A2 220 V 1-Phase/3-Phase 400W DMCNET Servo Drive
ASD-A2-0721-F	A2 220 V 1-Phase/3-Phase 750W DMCNET Servo Drive
ASD-A2-1021-F	A2 220 V 1-Phase/3-Phase 1.0kW DMCNET Servo Drive
ASD-A2-1521-F	A2 220 V 1-Phase/3-Phase 1.5 kW DMCNET Servo Drive
ASD-A2-2023-F	A2 220 V 3-Phase 2.0kW DMCNET Servo Drive
ASD-A2-3023-F	A2 220 V 3-Phase 3.0kW DMCNET Servo Drive
ASD-A2-4523-F	A2 220 V 3-Phase 4.5 kW DMCNET Servo Drive
ASD-A2-5523-F	A2 220 V 3-Phase 5.5kW DMCNET Servo Drive
ASD-A2-7523-F	A2 220 V 3-Phase 7.5kW DMCNET Servo Drive

### ASDA-B2-F DMCNET Servo Drives

ASD-B2-0121-F	B2 220 V 1-Phase/3-Phase 100W DMCNET Servo Drive
ASD-B2-0221-F	B2 220 V 1-Phase/3-Phase 200W DMCNET Servo Drive
ASD-B2-0421-F	B2 220 V 1-Phase/3-Phase 400W DMCNET Servo Drive
ASD-B2-0721-F	B2 220 V 1-Phase/3-Phase 750W DMCNET Servo Drive
ASD-B2-1021-F	B2 220 V 1-Phase/3-Phase 1.0kW DMCNET Servo Drive
ASD-B2-1521-F	B2 220 V 1-Phase/3-Phase 1.5 kW DMCNET Servo Drive
ASD-B2-2023-F	B2 220 V 3-Phase 2.0kW DMCNET Servo Drive
ASD-B2-3023-F	B2 220 V 3-Phase 3.0kW DMCNET Servo Drive

### ASDA-A2R-F DMCNET Servo Drives

ASD-A2R-0121-F	A2R 220 V 1-Phase/3-Phase 100W DMCNET Servo Drive
ASD-A2R-0221-F	A2R 220 V 1-Phase/3-Phase 200W DMCNET Servo Drive
ASD-A2R-0421-F	A2R 220 V 1-Phase/3-Phase 400W DMCNET Servo Drive
ASD-A2R-0721-F	A2R 220 V 1-Phase/3-Phase 750W DMCNET Servo Drive

### ASDA-M DMCNET Servo Drives

ASD-M-0721-F	M 220 V 1-Phase/3-Phase 750W DMCNET Servo Drive
ASD-M-1521-F	M 220 V 1-Phase/3-Phase 1.2kW DMCNET Servo Drive

# Ordering Information

ASDA-A2-E EtherCAT Servo Drives - 220 V Series	
ASD-A2-0121-E	A2 220V 1-Phase/3-Phase 100W EtherCAT Servo Drive
ASD-A2-0221-E	A2 220V 1-Phase/3-Phase 200W EtherCAT Servo Drive
ASD-A2-0421-E	A2 220V 1-Phase/3-Phase 400W EtherCAT Servo Drive
ASD-A2-0721-E	A2 220V 1-Phase/3-Phase 750W EtherCAT Servo Drive
ASD-A2-1021-E	A2 220V 1-Phase/3-Phase 1.0kW EtherCAT Servo Drive
ASD-A2-1521-E	A2 220V 1-Phase/3-Phase 1.5kW EtherCAT Servo Drive
ASD-A2-2023-E	A2 220V 3-Phase 2.0kW EtherCAT Servo Drive
ASD-A2-3023-E	A2 220V 3-Phase 3.0kW EtherCAT Servo Drive

ASDA-A2-E EtherCAT Servo Drives - 400 V Series	
ASD-A2-0443-E	A2 400V 3-Phase 400W EtherCAT Servo Drive
ASD-A2-0743-E	A2 400V 3-Phase 750W EtherCAT Servo Drive
ASD-A2-1043-E	A2 400V 3-Phase 1.0kW EtherCAT Servo Drive
ASD-A2-1543-E	A2 400V 3-Phase 1.5kW EtherCAT Servo Drive
ASD-A2-2043-E	A2 400V 3-Phase 2.0kW EtherCAT Servo Drive
ASD-A2-3043-E	A2 400V 3-Phase 3.0kW EtherCAT Servo Drive
ASD-A2-4543-E	A2 400V 3-Phase 4.5kW EtherCAT Servo Drive
ASD-A2-5543-E	A2 400V 3-Phase 5.5kW EtherCAT Servo Drive
ASD-A2-7543-E	A2 400V 3-Phase 7.5kW EtherCAT Servo Drive

ECML-S Linear Shaft Motor - Coil Assembly Model (Max. Thrust: 87.12N ~ 736N)	
ECML-S16 □ □ A2DNS	Shaft Diameter Ø16 Coil Assembly Model
ECML-S20 □ □ A2DNS	Shaft Diameter Ø20 Coil Assembly Model
ECML-S25 □ □ A2DNS	Shaft Diameter Ø25 Coil Assembly Model
ECML-S32 □ □ A2DNS	Shaft Diameter Ø25 Coil Assembly Model

ECML-SM Linear Shaft Motor - Magnetic Way Model (Total Length: 250 mm ~ 2310 mm)	
ECML-SM16 □ □ □ □	Shaft Diameter Ø16 Magnetic Way Model
ECML-SM20 □ □ □ □	Shaft Diameter Ø20 Magnetic Way Model
ECML-SM25 □ □ □ □	Shaft Diameter Ø25 Magnetic Way Model
ECML-SM32 □ □ □ □	Shaft Diameter Ø32 Magnetic Way Model



---

---

---

---

---

---

---

---

---

---

---

---

---

---

---

---

---

---

---

---

---

---

---

---

---



Smarter. Greener. Together.

## Industrial Automation Headquarters

### Delta Electronics, Inc.

Taoyuan Technology Center  
No.18, Xinglong Rd., Taoyuan District,  
Taoyuan City 33068, Taiwan  
TEL: 886-3-362-6301 / FAX: 886-3-371-6301

## Asia

### Delta Electronics (Shanghai) Co., Ltd.

No.182 Minyu Rd., Pudong Shanghai, P.R.C.  
Post code : 201209  
TEL: 86-21-6872-3988 / FAX: 86-21-6872-3996  
Customer Service: 400-820-9595

### Delta Electronics (Japan), Inc.

Tokyo Office  
Industrial Automation Sales Department  
2-1-14 Shibadaimon, Minato-ku  
Tokyo, Japan 105-0012  
TEL: 81-3-5733-1155 / FAX: 81-3-5733-1255

### Delta Electronics (Korea), Inc.

Seoul Office  
1511, 219, Gasan Digital 1-Ro., Geumcheon-gu,  
Seoul, 08501 South Korea  
TEL: 82-2-515-5305 / FAX: 82-2-515-5302

### Delta Energy Systems (Singapore) Pte Ltd.

4 Kaki Bukit Avenue 1, #05-04, Singapore 417939  
TEL: 65-6747-5155 / FAX: 65-6744-9228

### Delta Electronics (India) Pvt. Ltd.

Plot No.43, Sector 35, HSIIDC Gurgaon,  
PIN 122001, Haryana, India  
TEL: 91-124-4874900 / FAX : 91-124-4874945

### Delta Electronics (Thailand) PCL.

909 Soi 9, Moo 4, Bangpoo Industrial Estate (E.P.Z),  
Pattana 1 Rd., T.Phraksa, A.Muang,  
Samutprakarn 10280, Thailand  
TEL: 66-2709-2800 / FAX : 662-709-2827

### Delta Energy Systems (Australia) Pty Ltd.

Unit 20-21/45 Normanby Rd., Notting Hill Vic 3168, Australia  
TEL: 61-3-9543-3720

## Americas

### Delta Electronics (Americas) Ltd.

Raleigh Office  
P.O. Box 12173, 5101 Davis Drive,  
Research Triangle Park, NC 27709, U.S.A.  
TEL: 1-919-767-3813 / FAX: 1-919-767-3969

### Delta Greentech (Brasil) S/A

São Paulo Office  
Rua Itapeva, 26 – 3º Andar - Bela Vista  
CEP: 01332-000 – São Paulo – SP - Brasil  
TEL: 55-11-3530-8642 / 55-11-3530-8640

### Delta Electronics International Mexico S.A. de C.V.

Mexico Office  
Vía Dr. Gustavo Baz No. 2160, Colonia La Loma,  
54060 Tlalnepanlta Estado de Mexico  
TEL: 52-55-2628-3015 #3050/3052

## EMEA

### Headquarters: Delta Electronics (Netherlands) B.V.

Sales: Sales.IA.EMEA@deltaww.com  
Marketing: Marketing.IA.EMEA@deltaww.com  
Technical Support: iatechnicalsupport@deltaww.com  
Customer Support: Customer-Support@deltaww.com  
Service: Service.IA.emea@deltaww.com  
TEL: +31(0)40 800 3800

### BENELUX: Delta Electronics (Netherlands) B.V.

De Witbogt 20, 5652 AG Eindhoven, The Netherlands  
Mail: Sales.IA.Benelux@deltaww.com  
TEL: +31(0)40 800 3800

### DACH: Delta Electronics (Netherlands) B.V.

Coesterweg 45, D-59494 Soest, Germany  
Mail: Sales.IA.DACH@deltaww.com  
TEL: +49(0)2921 987 0

### France: Delta Electronics (France) S.A.

ZI du bois Challand 2, 15 rue des Pyrénées,  
Lisses, 91090 Evry Cedex, France  
Mail: Sales.IA.FR@deltaww.com  
TEL: +33(0)1 69 77 82 60

### Iberia: Delta Electronics Solutions (Spain) S.L.U

Ctra. De Villaverde a Vallecas, 265 1º Dcha Ed.  
Hormigueras – P.I. de Vallecas 28031 Madrid  
TEL: +34(0)91 223 74 20

Carrer Llacuna 166, 08018 Barcelona, Spain

Mail: Sales.IA.Iberia@deltaww.com

### Italy: Delta Electronics (Italy) S.r.l.

Ufficio di Milano Via Senigallia 18/2 20161 Milano (MI)  
Piazza Grazioli 18 00186 Roma Italy  
Mail: Sales.IA.Italy@deltaww.com  
TEL: +39 02 64672538

### Russia: Delta Energy System LLC

Vereyskaya Plaza II, office 112 Vereyskaya str.  
17 121357 Moscow Russia  
Mail: Sales.IA.RU@deltaww.com  
TEL: +7 495 644 3240

### Turkey: Delta Greentech Elektronik San. Ltd. Sti. (Turkey)

Şerifali Mah. Hendem Cad. Kule Sok. No:16-A  
34775 Ümraniye – İstanbul  
Mail: Sales.IA.Turkey@deltaww.com  
TEL: + 90 216 499 9910

### GCC: Delta Energy Systems AG (Dubai BR)

P.O. Box 185668, Gate 7, 3rd Floor, Hamarain Centre  
Dubai, United Arab Emirates  
Mail: Sales.IA.MEA@deltaww.com  
TEL: +971(0)4 2690148

### Egypt + North Africa: Delta Electronics

511 Cairo Business Plaza, North 90 street,  
New Cairo, Cairo, Egypt  
Mail: Sales.IA.MEA@deltaww.com