



Industrial Automation Headquarters
Delta Electronics, Inc.
 Taoyuan Technology Center
 No. 18, Xinglong Rd., Taoyuan City,
 Taoyuan County 33068, Taiwan
 TEL: 886-3-362-6301 / FAX: 886-3-371-6301

Asia
Delta Electronics (Jiangsu) Ltd.
 Wujiang Plant 3
 1688 Jiangxing East Road,
 Wujiang Economic Development Zone
 Wujiang City, Jiang Su Province,
 People's Republic of China (Post code: 215200)
 TEL: 86-512-6340-3008 / FAX: 86-769-6340-7290

Delta Greentech (China) Co., Ltd.
 238 Min-Xia Road, Pudong District,
 Shanghai, P.R.C.
 Post code: 201209
 TEL: 86-21-58635678 / FAX: 86-21-58630003

Delta Electronics (Japan), Inc.
 Tokyo Office
 2-1-14 Minato-ku Shibadaimon,
 Tokyo 105-0012, Japan
 TEL: 81-3-5733-1111 / FAX: 81-3-5733-1211

Delta Electronics (Korea), Inc.
 1511, Byucksan Digital Valley 6-cha, Gasan-dong,
 Geumcheon-gu, Seoul, Korea, 153-704
 TEL: 82-2-515-5303 / FAX: 82-2-515-5302

Delta Electronics Int'l (S) Pte Ltd
 4 Kaki Bukit Ave 1, #05-05, Singapore 417939
 TEL: 65-6747-5155 / FAX: 65-6744-9228

Delta Electronics (India) Pvt. Ltd.
 Plot No 43 Sector 35, HSIIDC
 Gurgaon, PIN 122001, Haryana, India
 TEL: 91-124-4874900 / FAX: 91-124-4874945

Americas
Delta Products Corporation (USA)
 Raleigh Office
 P.O. Box 12173, 5101 Davis Drive,
 Research Triangle Park, NC 27709, U.S.A.
 TEL: 1-919-767-3800 / FAX: 1-919-767-8080

Delta Greentech (Brasil) S.A
 Sao Paulo Office
 Rua Itapeva, 26 - 3° andar Edificio Itapeva One-Bela Vista
 01332-000-São Paulo-SP-Brazil
 TEL: +55 11 3568-3855 / FAX: +55 11 3568-3865

Europe
Deltronics (The Netherlands) B.V.
 Eindhoven Office
 De Witbogt 15, 5652 AG Eindhoven, The Netherlands
 TEL: 31-40-2592850 / FAX: 31-40-2592851

*We reserve the right to change the information in this catalogue without prior notice.



地址：上海市浦东新区民夏路238号
 邮编：201209
 电话：(021)5863-5678
 传真：(021)5863-0003
 网址：http://www.deltagreentech.com.cn

客服热线 ☎ 400-820-9595

上海 电话:(021)6301-2827 传真:(021)6301-2307
 南昌 电话:(0791)6255-010 传真:(0791)6255-102

武汉 电话:(027)8544-8265 传真:(027)8544-9500
 长沙 电话:(0731)8827-7881 传真:(0731)8827-7882

济南 电话:(0531)8690-7277 传真:(0531)8690-7099
 郑州 电话:(0371)6384-2772 传真:(0371)6384-2656

乌鲁木齐 电话:(0991)6118-160 传真:(0991)6118-289
 西安 电话:(029)8836-0640 传真:(029)88360640-8000

沈阳 电话:(024)2334-1612 传真:(024)2334-1163
 长春 电话:(0431)8892-5060 传真:(0431)8892-5065

合肥 电话:(0551)2816-777 传真:(0551)2816-555
 南京 电话:(025)8334-6585 传真:(025)8334-6554

南宁 电话:(0771)5879-599 传真:(0771)2621-502
 厦门 电话:(0592)5313-601 传真:(0592)5313-628

北京 电话:(010)8225-3225 传真:(010)8225-2308
 天津 电话:(022)2301-5082 传真:(022)2335-5006

成都 电话:(028)8434-2075 传真:(028)8434-2073
 重庆 电话:(023)8806-0306 传真:(023)8806-0776

杭州 电话:(0571)8882-0610 传真:(0571)8882-0603
 太原 电话:(0351)4039-475 传真:(0351)4039-047

广州 电话:(020)3879-2175 传真:(020)3879-2178
 哈尔滨 电话:(0451)5366-0643 传真:(0451)5366-0248

中达电通公司版权所有
 如有改动,恕不另行通知



台达有源无功补偿器

Delta Static Var Generator Quick Start



台达 有源无功补偿器 安装手册

Delta Static Var Generator Quick Start



www.delta.com.tw/ia



Before You Start

Please carefully read and be aware of the relevant safety information before operating this product for your and the product's safety.



- Please make sure that the power is off before configuring wires or installing the Static VAR Generator (SVG).
- Wait at least 10 minutes after turning off the AC power, as high voltage still exists inside the Static VAR Generator (SVG) and is extremely dangerous. Please make sure that the DC voltage drops to 0V before configuring wires or installation.
- The IC components on the Static VAR Generator's internal circuit board are susceptible to damage from electrostatic discharge. Please do not touch the circuit board with bare hands. Unauthorized alteration of components or circuits within the Static VAR Generator (SVG) should be avoided.
- The Static VAR Generator (SVG) and its components should not be installed near heat sources and flammable objects.
- If working under humid or live wire conditions is unavoidable, please stand on dry rubber mats or wooden boards and wear insulated gloves.



- All models come packaged with a User Manual and 2 keys. Please keep them safe as we are unable to provide replacements if the keys are lost or stolen. If you need help unlocking the device, please ask for assistance at a local dealer, or contact Delta's Industrial Automation Business Unit.
- Read and follow all instructions in this User Manual before installing, operating, or servicing the product. Please keep the User Manual, do not discard as it will be needed for further use.
- Before installation or maintenance, wear appropriate safety clothing, follow safety operating procedures, and use proper testing equipment as electric spark may damage the eyes, burn skin, damage equipment, or ignite combustibles.
- Only specialists from the manufacturer or authorized dealers may perform maintenance on the Static VAR Generator (SVG). Installation, wiring, and maintenance of the Static VAR Generator (SVG) may only be performed after the content of this manual is clearly understood.
- Have certified electrical professionals confirm that the Static VAR Generator (SVG) has been properly grounded to prevent injuries caused by leakage current.
- Even if the Static VAR Generator (SVG) is currently inactive, the main circuit terminals of the Static VAR Generator (SVG) can still carry dangerous voltage.
- If unpacked and used for over 3 months, the ambient temperature of the storage environment must not exceed 30°C as the capabilities of the electrolytic capacitors deteriorate easily when stored at a high ambient temperature without power. Please

do not leave the device powered off for a period longer than 1 year.

- ☑ Notes for the disinfection and disinfestation of packaging materials for transportation and installation (including wooden crates, planks, cardboard boxes, etc.):
 1. When disinfecting or disinfesting packaging materials, such as crates or cartons, please do not fumigate to avoid damaging internal components.
 2. Please use alternative environmental disinfection or disinfestation methods.
 3. High-temperature usage: Let the packaging sit for at least 30 minutes in temperature above 56°C.
 4. Fumigation should be avoided. Any damage caused by fumigation will not be covered by the warranty.

 **NOTE**

- The pictures and corresponding descriptions in this manual will feature the product with the outer casing or safety shields removed or disassembled to better explain the product in detail. As for the actual product in operation, please be sure to correctly install the outer casing and wirings in accordance with the rules and regulations, and operate the product following the instructions in the manual to ensure your safety.
- The illustrations in the manual may slightly differ from the actual product for demonstration purposes, but will not affect the rights and interests of the customer.
- When product documentation is updated or modified, the latest edition can be downloaded from the industrial automation product page on the Delta Electronics website.

Installation Checklist

The following table provides installation details so as to enable quick and convenient assembly by to a professional electrical engineer. These steps can prevent human errors that cause unnecessary harm.

NOTE

Only qualified electrical engineers should adjust the equipment. Carefully read and follow the manual's Before You Start safety instructions. Ignoring the safety instructions can cause injury or death.

Installation of Equipment	
<input type="checkbox"/>	Is the equipment being installed in a well ventilated, indoor area with a relative humidity of less than 90% without condensation?
<input type="checkbox"/>	Is the operating environment temperature maintained at -10~45°C (SVG300AXXA-XX model); -10~40°C (SVG500AXXA-XX model)?
<input type="checkbox"/>	Installation Complies with Degrees of Pollution: Degree 2 (for a factory environment) and contamination-free substances without e-waste contaminated dust particles.
<input type="checkbox"/>	The location of the equipment must be approved for fire safety, must be clean, must not be within the vicinity of corrosive gases, and must not vibrate.
<input type="checkbox"/>	Is there any weight or items stacked on top of the Static VAR Generator?
<input type="checkbox"/>	Is it placed on level ground?
Electrical Installation	
<input type="checkbox"/>	The equipment is grounded
<input type="checkbox"/>	The equipment's input voltage value is consistent with the supply voltage
<input type="checkbox"/>	Is the wiring for the input terminals correct?
<input type="checkbox"/>	Has the power cable been properly chosen? Refer to the User Manual.
<input type="checkbox"/>	The input terminal must be connected to the fuse and isolation switch. Refer to the User Manual.
<input type="checkbox"/>	Does the voltage value of the equipment's transformer match the voltage supply?
<input type="checkbox"/>	Is the orientation of the CT installation correct? "Current transformer grid terminal: K (S1); Load terminal: L (S2)"
<input type="checkbox"/>	Is the installation of the CT diameter and length correct? Please refer to the User Manual.
<input type="checkbox"/>	Confirm that there are no other conductors and assembly parts inside the Static VAR Generator (SVG).
<input type="checkbox"/>	Confirm that the cover is back in place after adjusting the voltage of the transformer.
Before Starting the Device	
<input type="checkbox"/>	Before starting the Static VAR Generator (SVG), determine whether the I/O of the power supply relay is in an uncharged state.
<input type="checkbox"/>	When the power cable wiring is complete, check that the cabinet door is closed.
<input type="checkbox"/>	When the power cable wiring is complete, to ensure safety, do not touch the cable.
<input type="checkbox"/>	If the cable is exposed, please provide clear warning signs such as "Do Not Touch the Cable".











Turning On the Power Voltage	
<input type="checkbox"/>	Turn on the main breaker of the power transformer
<input type="checkbox"/>	Turn on the device's circuit breaker/isolation switch and the transformer's circuit breaker
<input type="checkbox"/>	After the power is on, check whether the fan is operating normally
<input type="checkbox"/>	After the power is on, check whether the vent is blocked
<input type="checkbox"/>	After the power is on, check whether the display of the power quality control system is normal
<input type="checkbox"/>	After the power is on, check whether the touch screen of the power quality control system is normal

Table of Contents

01 Product Overview	1-1
1-1 Usage.....	1-1
1-2 Storage.....	1-1
1-3 Transportation.....	1-2
02 Product Installation.....	2-1
2-1 Installation.....	2-1
2-1-1 Installation Precautions.....	2-1
2-1-2 Description of Appearance.....	2-2
2-2 Internal Introduction.....	2-4
2-2-1 Description of Nameplate.....	2-4
2-2-2 Part Locations.....	2-4
2-3 Cabinet Installation.....	2-6
2-4 Wiring Installation.....	2-11
2-4-1 Wiring.....	2-15
2-5 Exterior Dimensions.....	2-16
03 Specifications	3-1
3-1 Specifications Table.....	3-1
3-2 Optional Accessories.....	3-1
3-2-1 Current Transformer.....	3-1
3-3 Control Terminal Descriptions.....	3-1
3-4 Lightning Protection Module.....	3-1
3-5 Fans.....	3-1
3-6 Transformer.....	3-1
3-7 AC/DC Power Source.....	3-1
04 Power Quality Management System.....	4-1
05 Maintenance.....	5-1





01 Product Overview

1-1 Usage



-  The Static VAR Generator is used to compensate harmonics depending on the harmonic and the Static VAR Generator's compensation capacity so that compensation will not be affected due to insufficient capacity.
-  An external harmonic current detection CT needs to be installed for the Static VAR Generator to perform harmonic treatment.
-  To ensure the Static VAR Generator performs with maximum efficiency, please install the device in a well ventilated environment and do not block or cover the air vents. Refer to Figure 2-1a/ 2-1b.
-  Please maintain the Static VAR Generator's operating ambient temperature at -10~45°C (SVG300AXXA-XX model); -10~40°C (SVG500AXXA-XX model). Abnormal operation could occur if the temperature exceeds this range.
-  Upon receiving the product, please first examine the carton for any signs of abnormal damage during shipping. In such cases, please contact our local dealer or Delta sales immediately to help with relevant matters.
-  Once you confirm that the Static VAR Generator's carton has no signs of abnormal damage, remove the manual located on the carton and have a professional technician install the Static VAR Generator according to the instructions.
-  After removing the carton, please check and make sure the product nameplate matches the product model you purchased. Refer to 2-2-1 Description of Nameplate.
-  Please keep the operating environment dust-free. Do not allow any fiber, paper scraps, sawdust, metal scraps or other foreign objects to enter the Static VAR Generator or attach to the cooling fans, as this will cause the Static VAR Generator to operate abnormally.
-  When wiring the Current Transformer, please note the wiring positions for the input terminals "K1, K2, K3" and the output terminals "L1, L2, L3". Please do not connect the wires to the wrong terminals because the machine will not work.
-  This product complies with the following safety and EMC standards

International Standards	Chinese National Standards
IEEE519-1992	GB/T14549-93 (Quality of electric energy supply - Harmonics in public supply networks) SD 126-84 Provisional regulations on management of power system harmonics Regulations on the administration of electric power dispatch to networks and grids
IEC/EN61000-3-12	
IEC/EN61000-3-4	
IEC/EN61000-3-2	
IEC/EN61000-2-2	
IEC/EN61000-3-3	
IEC/EN61000-2-4	
TOR D2	
G5/4	
D-A-CH-CZ	

1-2 Storage

-  If immediate installation is not needed, store the Static VAR Generator in a well ventilated area indoors with relative humidity <90% without condensation. The Static VAR Generator should be installed according to the degree of pollution: Degree 2 (for a factory environment) and clean circulating air.
Clean circulating air is defined as air without contaminated substances or e-waste contaminated dust particles.
-  This product is designed to maximize reliability. If installed and used correctly, this product should provide a lasting, hassle-free service life. Visual inspections should be conducted at least every 6 months to ensure the cables are fastened and to avoid the accumulation of dust, dirt, or other unrelated particles, as these will affect heat dissipation.
-  The storage location must be qualified for fire safety, be dust-free, without corrosive gases in the surrounding area, and without vibration. Please do not stack heavy objects on top of the Static VAR Generator.
-  Please do not place the Static VAR Generator on a slope or uneven ground to avoid damage the Static VAR Generator.
-  Please do not let any fiber, paper scraps, sawdust, metal scraps or other foreign objects enter the Static VAR Generator or attach to the cooling fans. The iron grate at the Static VAR Generator's air inlet can get clogged by foreign objects. Please clean the iron mesh manually on a regular basis. Before cleaning the iron grate, the Static VAR Generator must first be turned off to ensure personal safety. Proper protective equipment such as insulating gloves or protective goggles must be worn before performing maintenance.

1-3 Transportation

-  All models are floor-standing cabinets. When transporting and installing the Static VAR Generator, do not lay it flat, tilt it, or lift a side to avoid damaging the Static VAR Generator.
-  When moving, do not tilt, lie flat, or lift by one side. The Static VAR Generator must be transported upright. Please be sure to adhere to the aforementioned guidelines to prevent the models from being damaged due to improper transportation.

Unpacking Description

Floor Cabinet Models (SVG300A43A-11 is shown in the figure below as an example)

- 1) With a flat-head screwdriver, pry open all 10 fasteners on both sides of the carton. (As shown in the figure below)

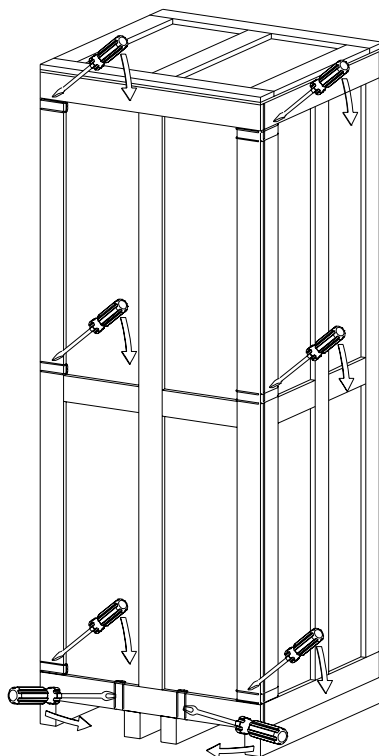

- 2) Remove the carton and 4 EPE from both sides. Note that the front of the cabinet is facing the lid of the carton (the direction as indicated by the elongated arrow) (see Figure 1-5 below). Open the outer lid of the model by the handle, and you will find the user manual and the keys for the outer lid attached to the inner side of the outer lid (see Figure 1-6 below). Please keep the keys safe as only 2 keys are included in each model. The keys cannot be replaced if lost.

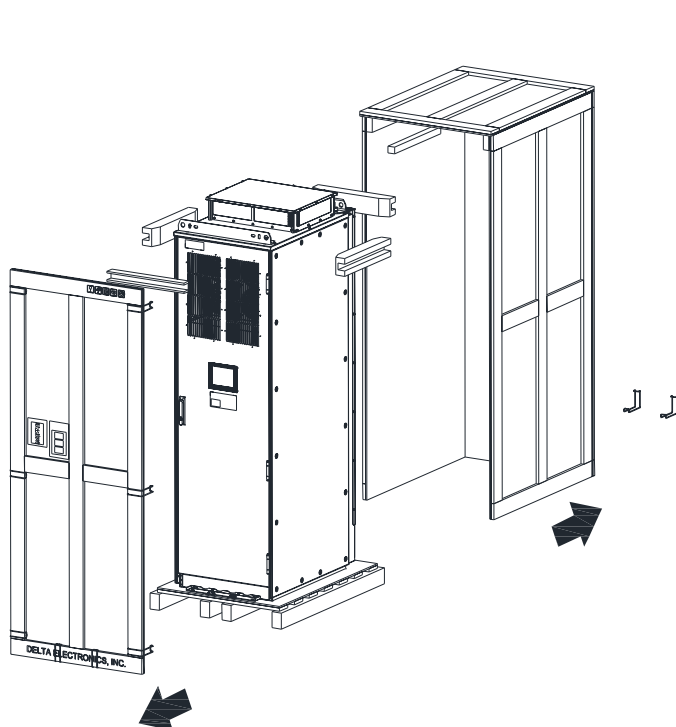

Figure 1-5

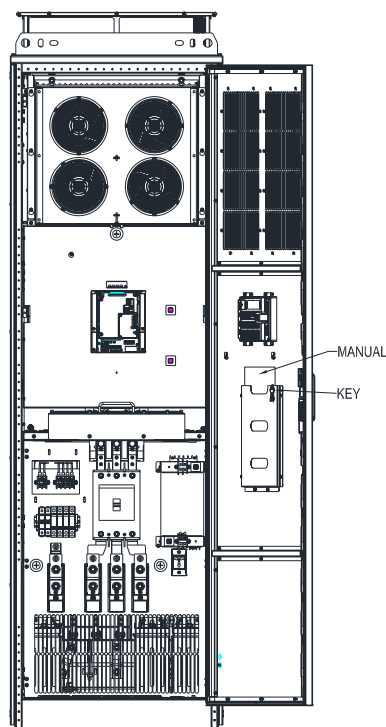

Figure 1-6

- 3) As shown in Figure 1-7(a) below, remove the 12 base-fixing M5 screws. As shown in Figure 1-7(b) below, remove the 8 base-fixing M5 screws.
- 4) With hoist rings [see Figure 1-8(a)(b) below], lift the Static VAR Generator and place into the designated position. (For more details on hoist ring devices please refer to 1-3-3 Hoist Ring Installation)

Figure 1-8(a): Static VAR Generator + L-shaped iron plate

Figure 1-8(b): Static VAR Generator

- 5) For detailed methods on installing floor cabinet models, please refer to 2-3 Cabinet Installation.

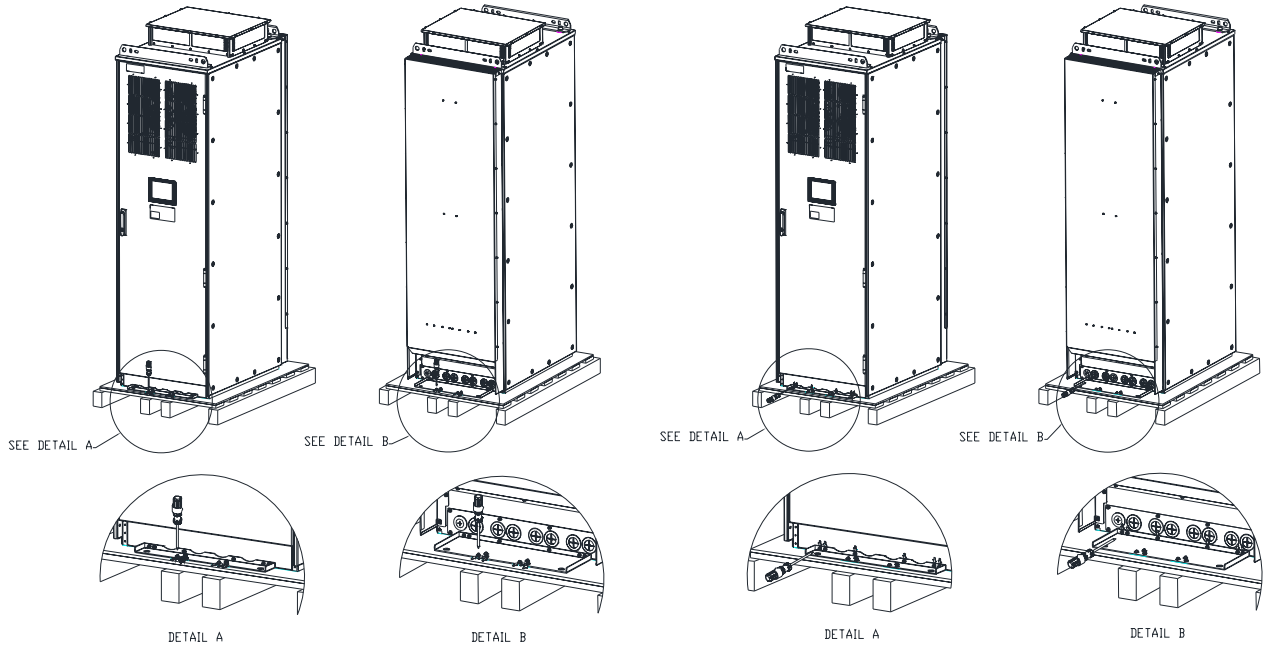

Figure 1-7(a)

Figure 1-7(b)

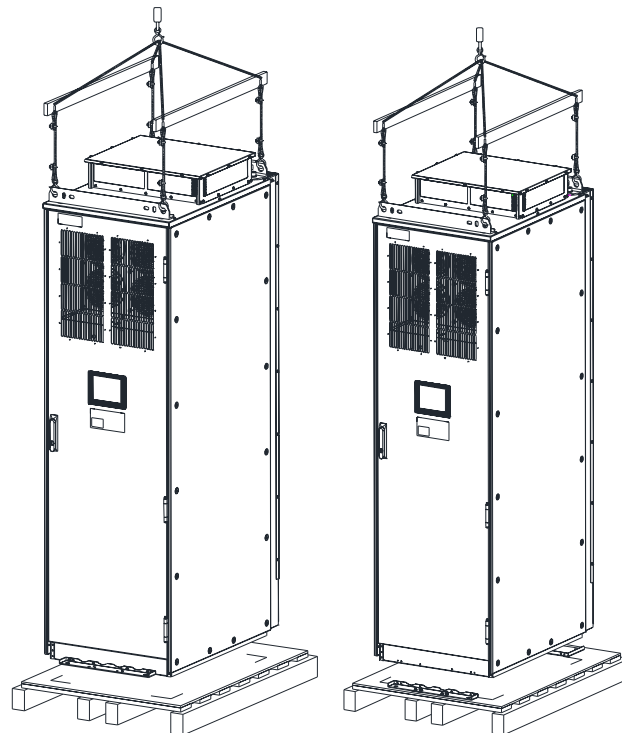

Figure 1-8(a)

Figure 1-8(b)

Hoist Ring Installation

SVG300AXXA-11/SVG500AXXA-11

Set up the lifting hole position

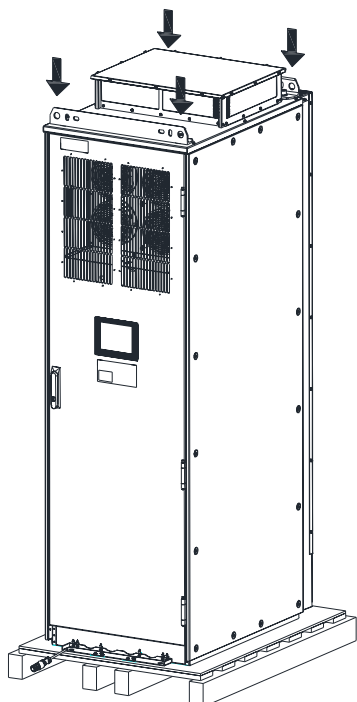

Note how hoist rings are installed. Please avoid inappropriate installation that will cause the SVG lifting holes to deform.

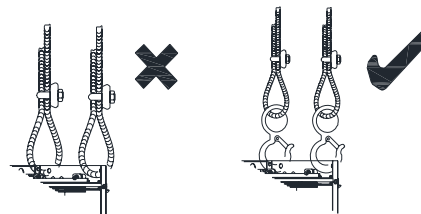

SVG300AXXX-XX

Model Weight: 650 kg (1,433 lbs) ± 10% (margin of error)

SVG500AXXX-XX

Model Weight: 1,100 kg (2,425 lbs) ± 10% (margin of error)

Please be aware of the lifting angle between the SVG lifting holes and the lifting hook. (For the purpose of the base-fixing iron plate, please refer to 2-3 Cabinet Installation)

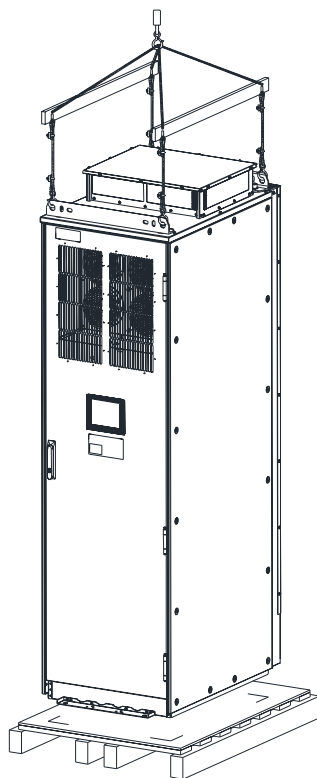
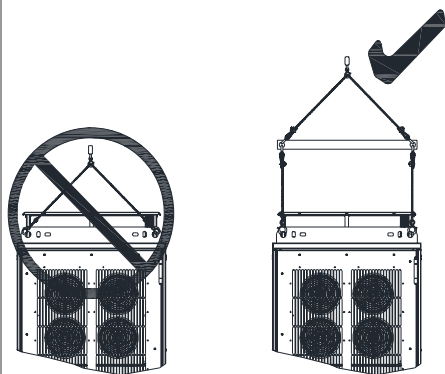

With base-fixing iron plate

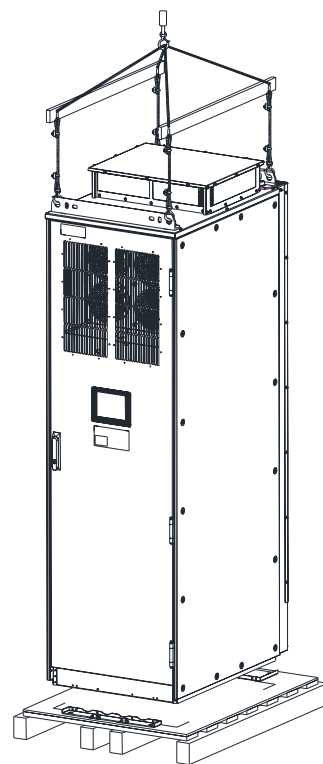







Without fixing iron plate

02 Product Installation

2-1 Installation

2-1-1 Installation precautions

-  Before installing the Static VAR Generator (SVG) cabinet, please make sure the Static VAR Generator's (SVG) input terminal system power is turned off to keep the wiring technician safe.
-  When configuring wires for the power input terminal of the Static VAR Generator (SVG), please be aware of the position and status of the switches connecting the Static VAR Generator (SVG) and mains wirings. Wait at least 10 minutes after turning off the Static VAR Generator (SVG) until DC voltage of the Static VAR Generator (SVG) drops to 0V before disassembling to ensure the safety of installation personnel.
-  Please read carefully and follow the installation procedures, and take precautions during installation. Study local electrical code, and make sure the input power matches the rated voltage of the equipment being installed.
-  Check that the wirings are connected correctly on the power supply end and the control parts, and tighten the wiring screws. Refer to 2-4 Wiring Installation.
-  It is strictly prohibited to lay flat, tilt, lift one side of the Static VAR Generator (SVG) when installing to avoid damaging the Static VAR Generator (SVG).
-  When installing the current transformer, please note that the grid end of the current transformer should be connected to K (S1), and the load end to L (S2). For more details on the installation of the current transformer, please refer to 3-2 Optional Accessories.

Air flow rate for cooling						
Model No.	Flow Rate (cfm)			Flow Rate (m ³ /hr)		
	External	Internal	Total	External	Internal	Total
SVG300A43A-11	631	411	1042	1073	699	1772
SVG300A63A-11	1235	411	1646	2098	699	2797
SVG500A43A-11	1236	521	1756	2100	885	2985
SVG500A63A-11	1236	521	1756	2100	885	2985
※ The table shows the required air flow rate for each model when installing single units in a closed space.						
※ For multiple units, multiply the required air flow rate for single-unit installation by the number of units installed.						

SVG Power Dissipation			
Model No.	Power Dissipation (watt)		
	Loss External(Heat sink)	Internal	Total
SVG300A43A-11	4857	2948	7806
SVG300A63A-11	7743	3292	11035
SVG500A43A-11	7891	6694	14585
SVG500A63A-11	10506	5662	16168

SVG Power Dissipation

- ※ The table shows the required heat dissipation rate due to heat loss for each model when installing single units in a closed space.
- ※ For multiple units, multiply the heat dissipation rate for single units by the number of units installed.
- ※ The heat dissipation data are calculated based on each model operating under rated voltage, current, and default carrier wave.

2-1-2 Appearance descriptions

SVG300AXXA-XX/SVG500AXXA-XX

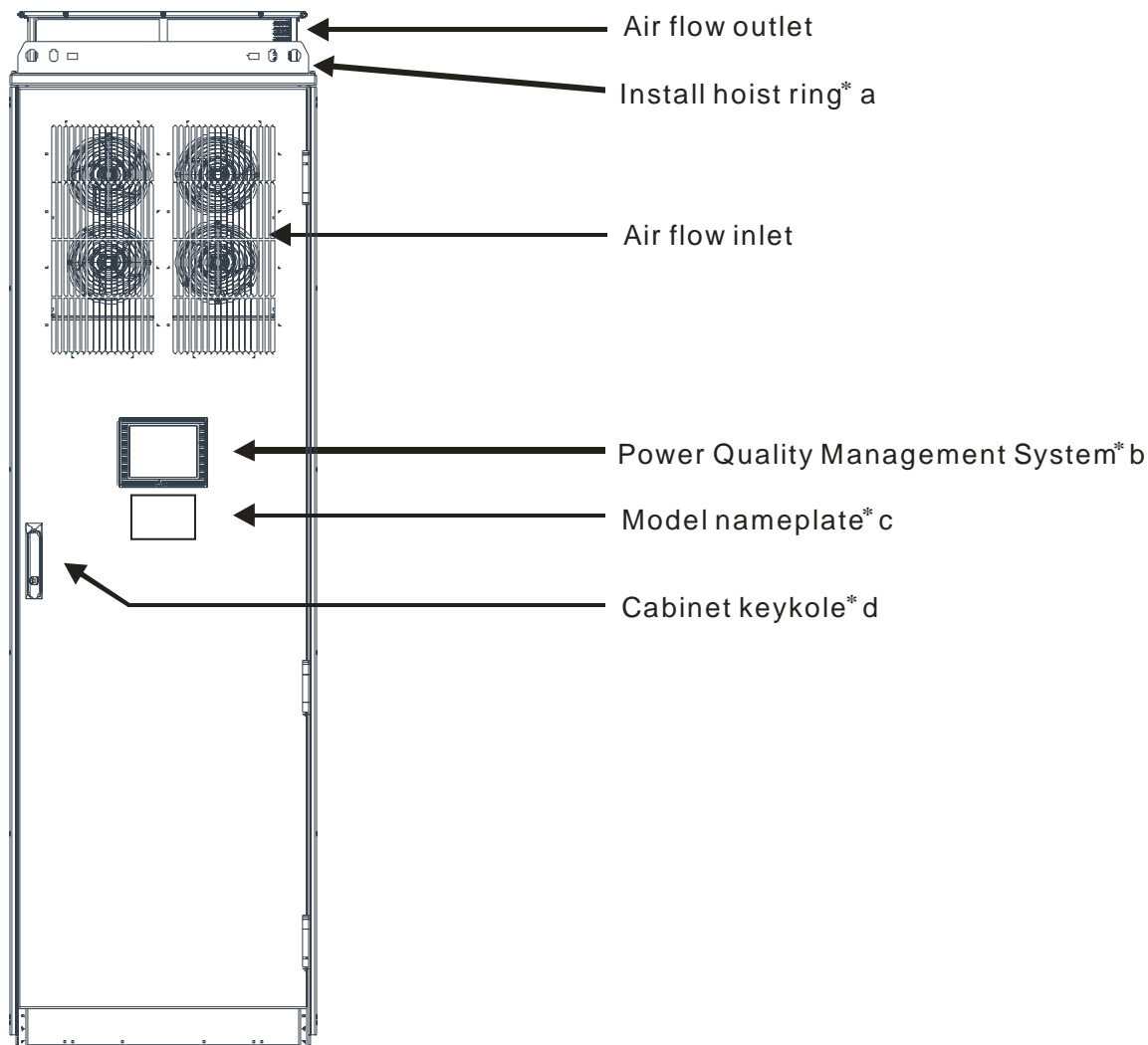

*a For more details on hoist ring installation, please refer to 1-3-3 Hoist ring installation

*b For more details on power quality management system, please refer to 04 Power Quality Management System

*c For more details on nameplate descriptions, please refer to 2-2-1 Nameplate descriptions

*d Two keys are attached inside the cabinet, which can be used to open/lock the cabinet. Please keep the keys in a secure location and do not lose them.

2-2 Internal Introduction

2-2-1 Description of Nameplate

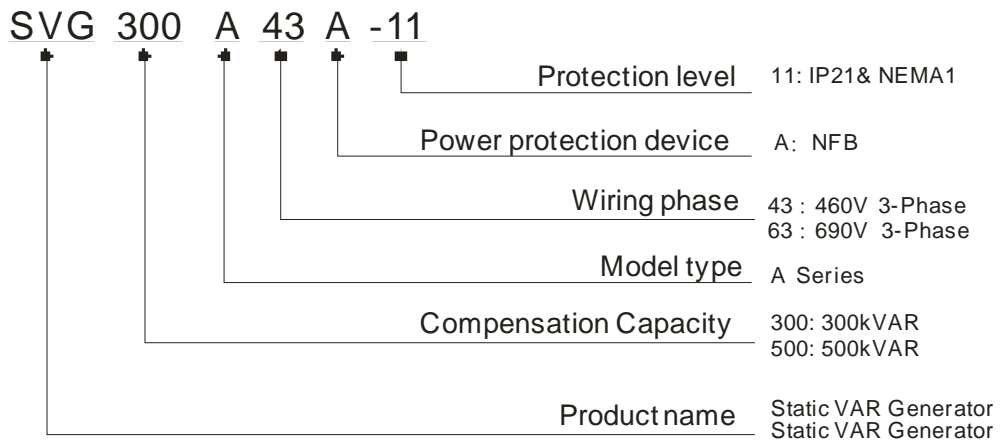
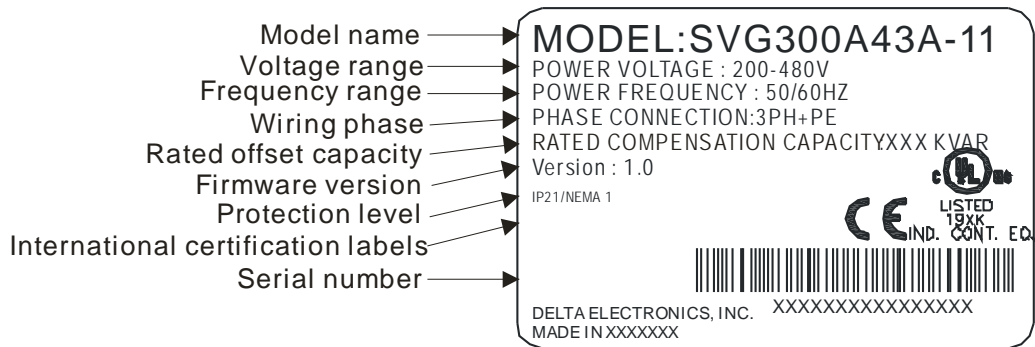

2-2-2 Part Locations

- ☑ The figures below are for illustrative purposes only. Actual models may differ from the images displayed.

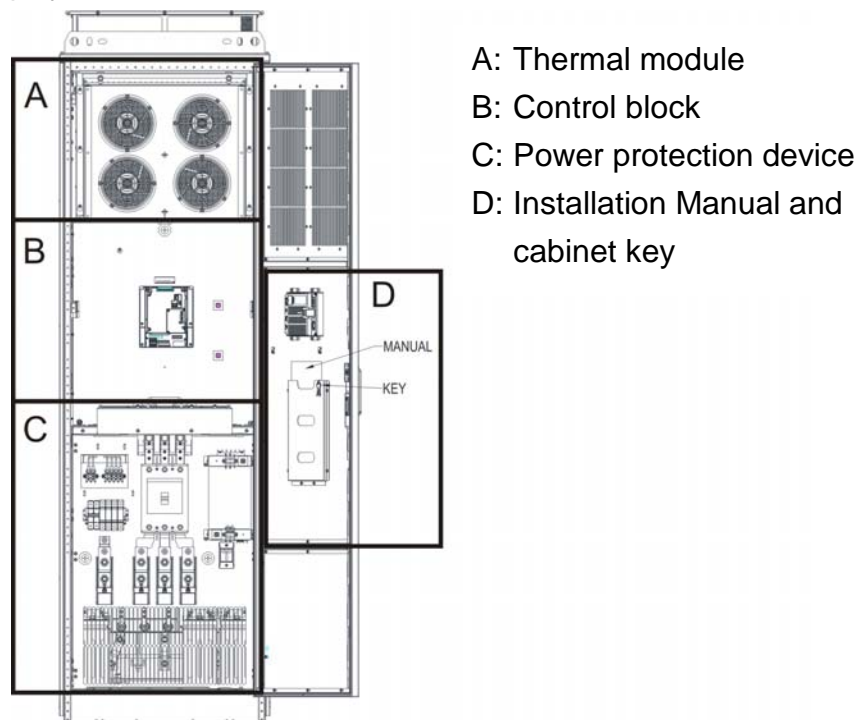

- ☑ Thermal block

SVG300AXXA-11/ SVG500AXXA-11

Area A in the figure is where the thermal module and the air outlet are located. Keeping the

air flow unobstructed at the air inlet/outlet increases the efficiency of the SVG

☑ Control block

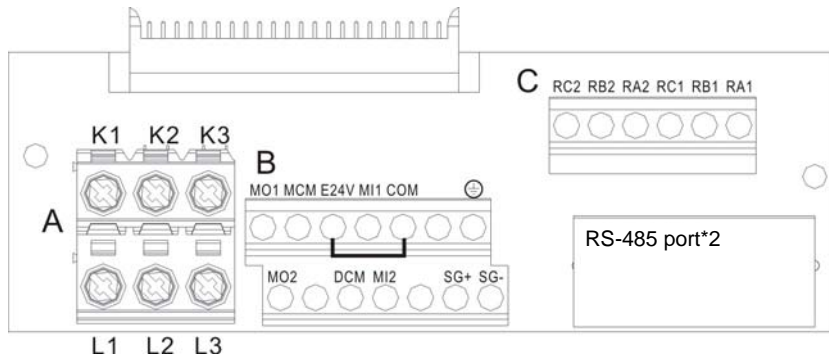

1. For detailed descriptions of the control terminals, please refer to 3-3 Control Terminal Descriptions.
2. The lightning protection module is located in the control block; in all other models, it is located in the power protection module. For detailed lightning protection module specs, please refer to 3-4 Lightning Protection Module.

Wiring precautions:

Place the wires into the wiring hole and tighten the wirings with a flathead screwdriver, note that it is best to leave 5mm spacing at the wiring end. Note: For terminals at positions B and C, place the wires neatly into the wiring hole when wiring without using terminal blocks. For terminals at position A, terminal blocks are required.

Position	Suitable wire size	Torque
A	24~10AWG	14.3Kg-cm(12.41 lb-in) (1.4N.m)
B	26~16AWG	8Kg-cm(6.94 lb-in) (0.78N.m)
C		5Kg-cm(4.3 lb-in) (0.49N.m)

☑ Power protection module

- 1) All SVG models use NFB protection devices.
- 2) For specs on internal circulation fans, please refer to 3-5 Fans.
- 3) Regarding the transformer specs, voltage must be adjusted before powering on; for more detailed descriptions, please refer to 3-6 Transformer.
- 4) AC to DC power specs, please refer to 3-7 AC/DC Power Supply.
- 5) All SVG models have current transformer (CT) installed externally. CT is a necessary accessory. For detailed CT specs, please refer to 3-2 Optional Accessories.

2-3 Cabinet Installation

SVG300AXXA-11/SVG500AXXA-11

- ☑ Before beginning installation, please check the appearance of the model and confirm there is no visible damage. Please follow the installation instructions in the manual to ensure the safety of both the product and personnel.
- ☑ When taking out the cabinet from the carton, please note whether the base-fixing iron plates (L-shaped iron plates) need to be used in conjunction. If the base-fixing iron plates are not needed, they can be left on the carton's base when taken out (as shown in figure 1-8(b)).
- ☑ When installing the cabinet, make sure it is installed in a place that is well ventilated and dust-free. Do not let any fiber, paper scraps, sawdust, metal scraps, or other foreign objects enter the Static VAR Generator or become attached to the cooling fans, as this will cause the Static VAR Generator to not operate properly.
- ☑ When installing the cabinet, the cooling distances are shown in figures 2-1a & 2-1b.
 1. Head space: To ensure that the model achieves an Ingress Protection rating of IP54, the shortest distance for the space reserved for the replacement of the fans must be at least 400mm (15.75 inches).
 2. Back space: If the user's installation requires wires coming in from the top, enough space must be reserved behind the cabinet for the power cable to come in. The shortest distance must be at least 200mm (7.87 inches).
 3. Side space: The cabinet door opens from left to right, therefore the side of the cabinet cannot be placed directly against a wall; some space must be left on the side for the doors to open. The shortest distance from the side to the wall must be at least 275mm (10.83 inches), and the door must be able to open to at least 120°.

SVG300&SVG500

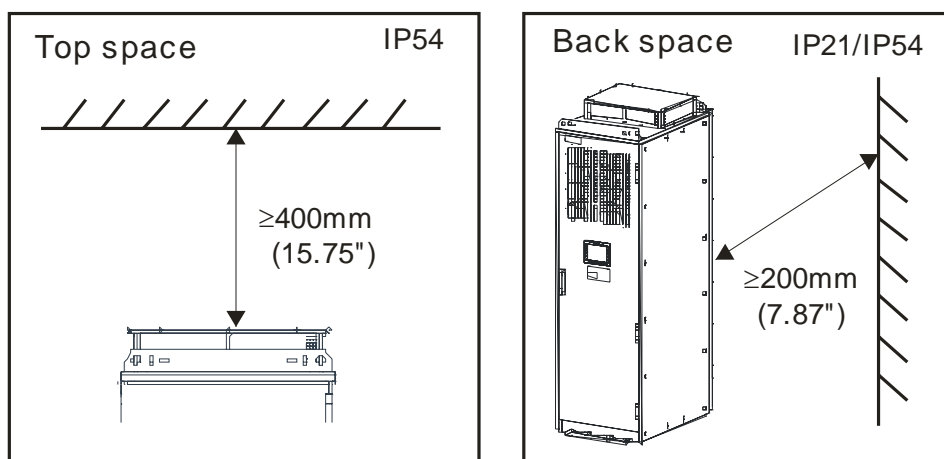

Figure 2-1a

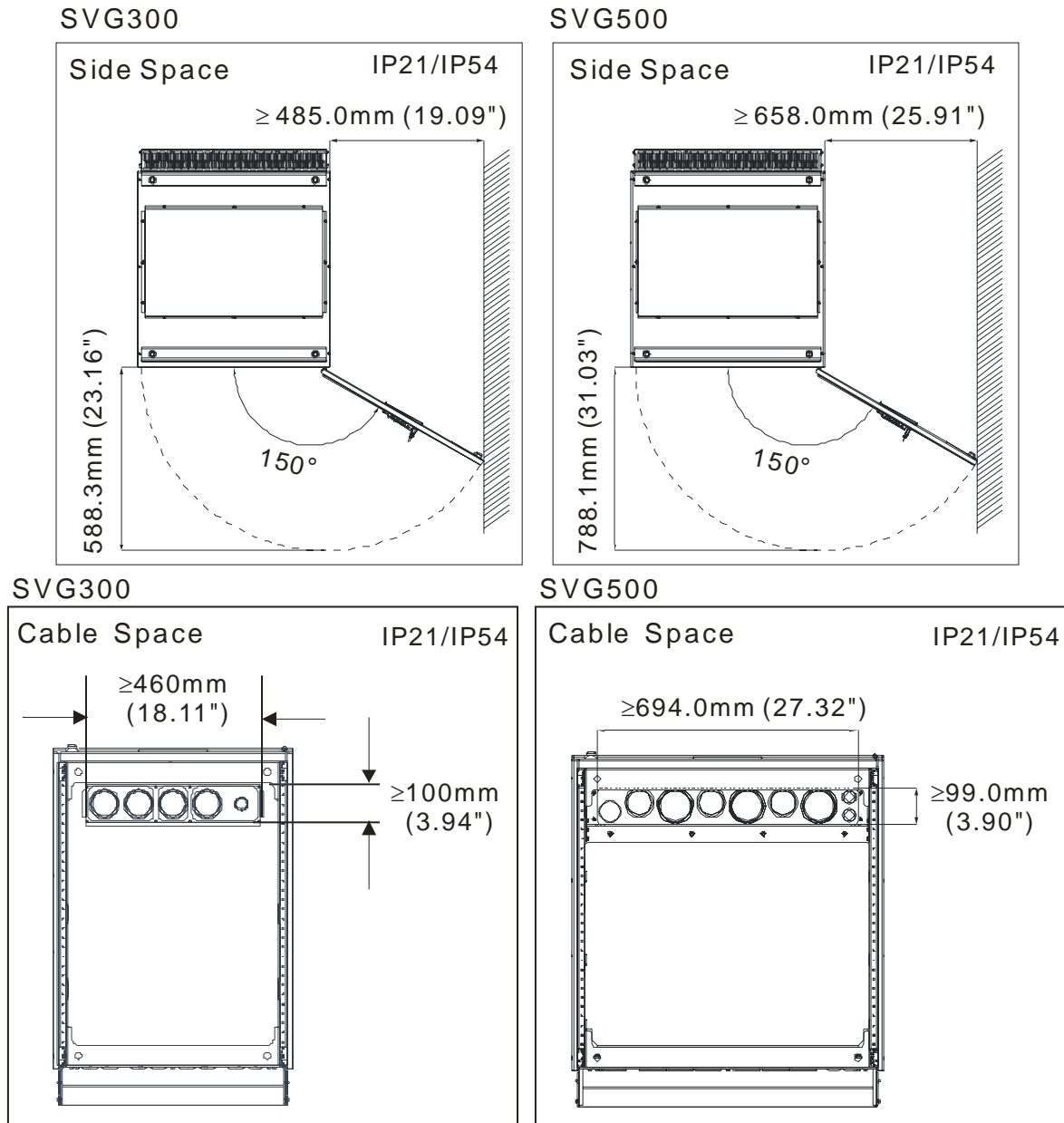

Figure 2-1b

4. Cable entry space: When cable trenches are used (as shown in Figure 2-1b), be careful of where the cabinet is being installed. The "Cabinet cable entry hole" must be right above the cable trenches with a distance of no greater than 645 mm (25.39 inches), as shown in Figure 2-2.
 - (A) At the location where the cabinet is going to be placed, some spaces must be reserved to support the cabinet. Reserved supporting spaces are shown in figure 2-2, please keep the distances at 55~100mm (2.16~3.94 inches), to ensure the cabinet is installed securely. Note: Must be placed on level ground.
 - (B) Cooling air must not be allowed to enter the cabinet through the base board via the cable trenches. To ensure the cabinet's protection rating, please select Delta's wiring board. If the customer's own wiring board is used, please make sure to check its protection rating, and confirm that it complies with fire safety and EMC requirements. If the cabinet is damaged due to customer's own wiring board, the customer shall be responsible for any resulting service fees. See figure 2-3.

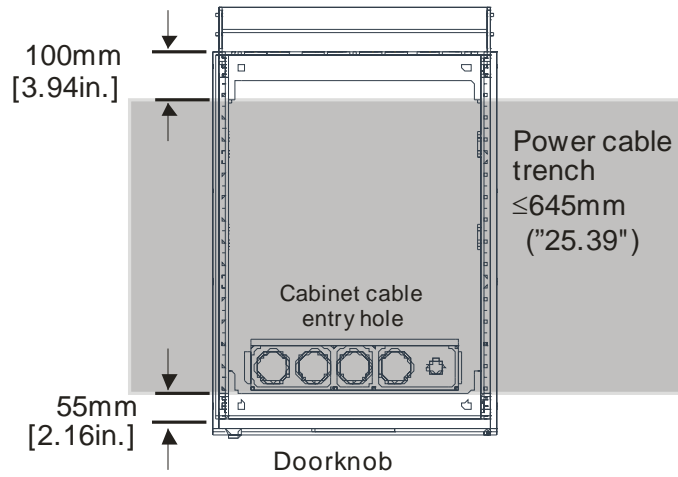

Figure 2-2

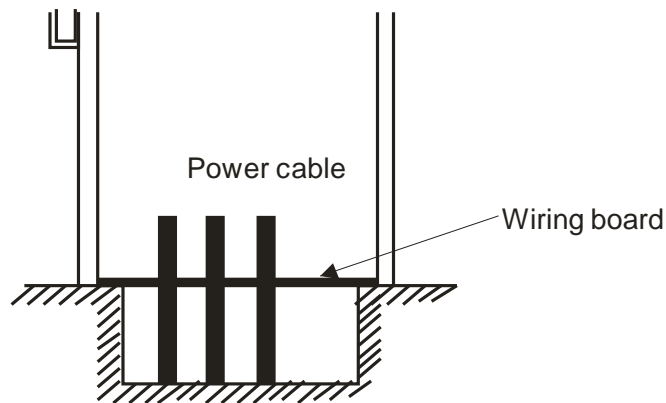

Figure 2-3

☑ Cabinet installation:

1. During installation, the customer can decide whether the 2 base-fixing iron plates (L-shaped iron plates) are needed based on their available equipment and the use requirements, as shown in figure 2-4; A: keep the L-shaped iron plates on the cabinet; B: the L-shaped iron plates not needed.

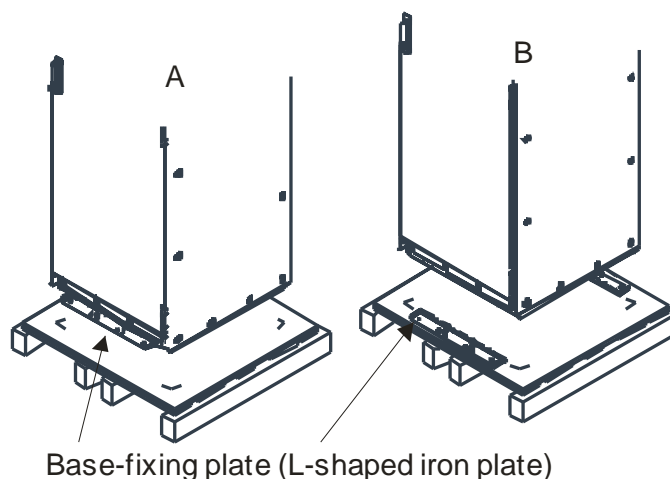

Figure 2-4

2. During installation, follow Figures 2-5, 2-6, and 2-7 to securely mount the fixing holes and distance (Note 1 & 2).
3. Installation: As shown in Figures 2-5 and 2-7, after opening the cabinet door and cabinet sides, the base-fixing holes a1 and a2 located in the front of the cabinet and base-fixing holes a3 and a4 located in the back of the cabinet are Delta's cabinet installation fixing holes

(Note 1 & 2).

Note 1: Aperture of fixing holes a1 ~ a4: Ø 18mm; aperture of fixing holes a5, a6: Ø 14mm.

You can use (Ø18) M16 or (Ø14) M12 studs for fixation.

Note 2: Before using the base-fixing holes a3, a4 located in the back, remove the 38 S1-S19, M5 screws of the side boards as shown in Figure 2-5 to fix a3 and a4. Afterward, please screw the side boards back into their original position. Screw torque: 24 to 26 kg-cm [20.83 to 22.57lb.in] (2.35 to 2.55N.m). (Note 4)

Note 3: If the sideboards get in the way, please lock the fixing holes in the back onto the L-shaped iron plates, as shown in c3 to c4 of Figure 2-7.

Note 4: To remove the side boards, as shown in Figure 2-5, loosen the S1 to S3 screws first, and then remove the S4-S19 screws. Pull the board open approximately 45° to remove the board to facilitate fixing the base-fixing holes a3, a4 located in the back. Afterward, please screw the side boards back into their original position.

4. 5 other installation methods are also provided. Please select a suitable installation method. All other installation methods are not approved by Delta, and Delta will not be responsible for damages dealt to the cabinet due to inappropriate installation methods.
5. If a customer needs to elevate the cabinet because of the venue, please refer to Figure 2-8 to elevate the four sides to ensure the safety of the cabinet.

In situations where the installation environment may cause the whole system to sway, please use installation method 4 as the fixing method.

Installation 1: Refer to Figure 2-7, fix the base-fixing holes a1 and a2 at the front of the cabinet, as well as the top fixing holes a5 and a6 at the back.

Installation 2: Refer to Figure 2-7, fix the L-shaped iron plate c1 to c4.

Installation 3: Refer to Figures 2-6 and 2-7, fix the L-shaped iron plate c1, c2 and top fixing holes a5, a6 at the back.

Installation 4: Refer to Figures 2-6 and 2-7, fix the base-fixing holes a1, a2 at the front of the cabinet, base-fixing holes a3, a4 at the back, and the top base-fixing holes a5, a6 at the back.

Installation 5: Refer to Figures 2-6 and 2-7, fix the L-shaped iron plate c1 to c4 and top fixing holes a5, a6 at the back.

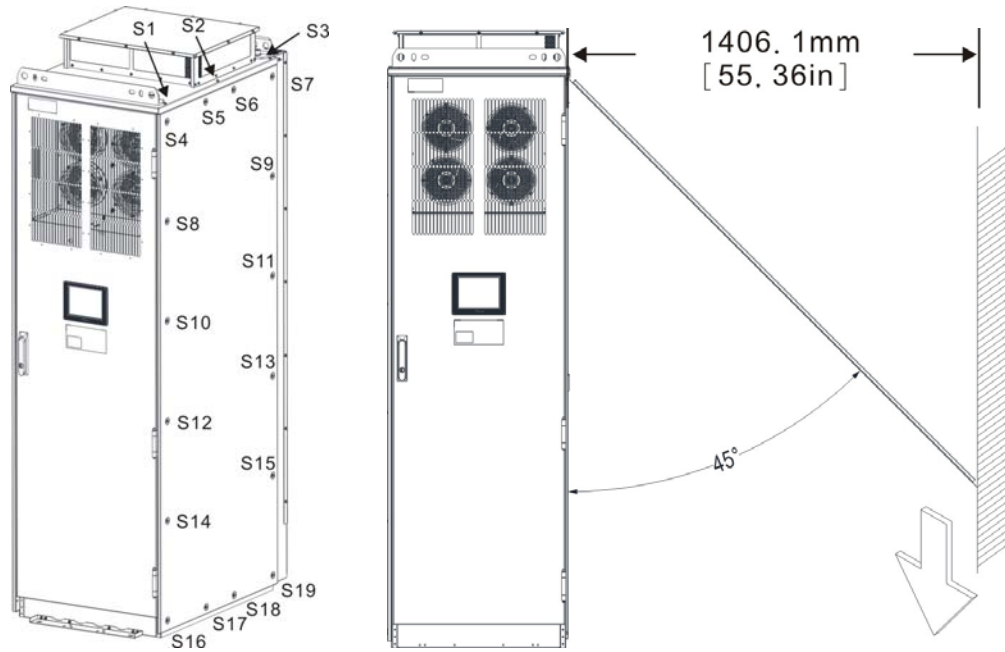
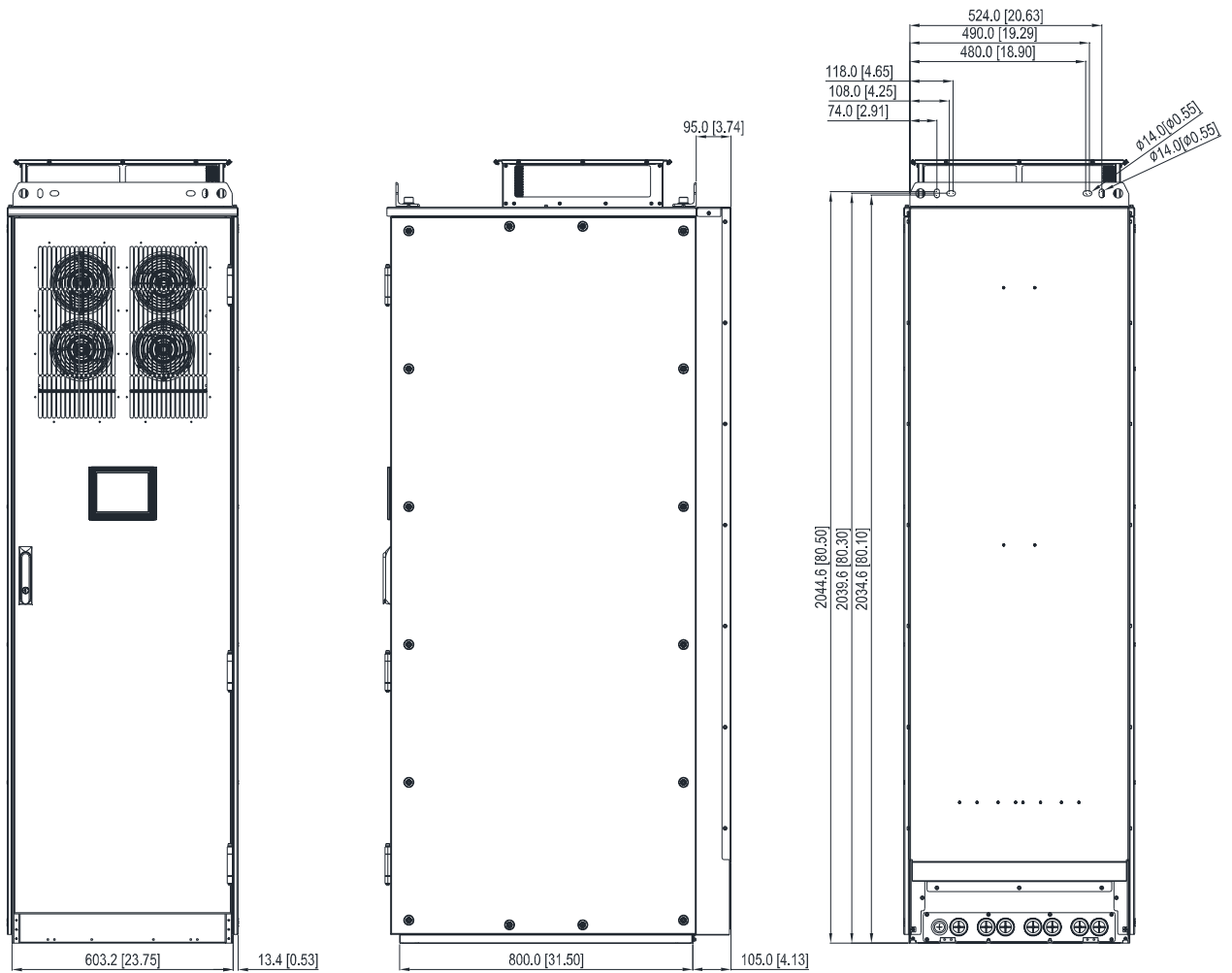

Figure 2-5 The two side boards and removal method

SVG300

Unit: mm[inch]



SVG300

Unit: mm[inch]

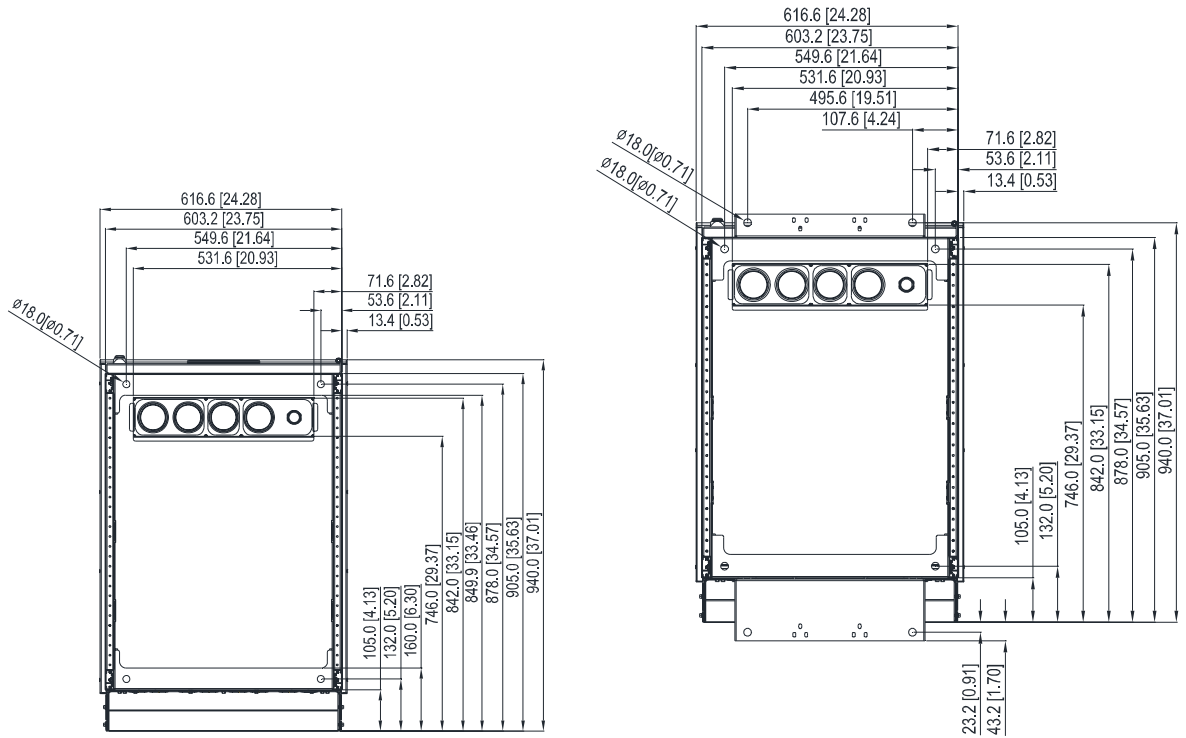

SVG500

Unit: mm[inch]

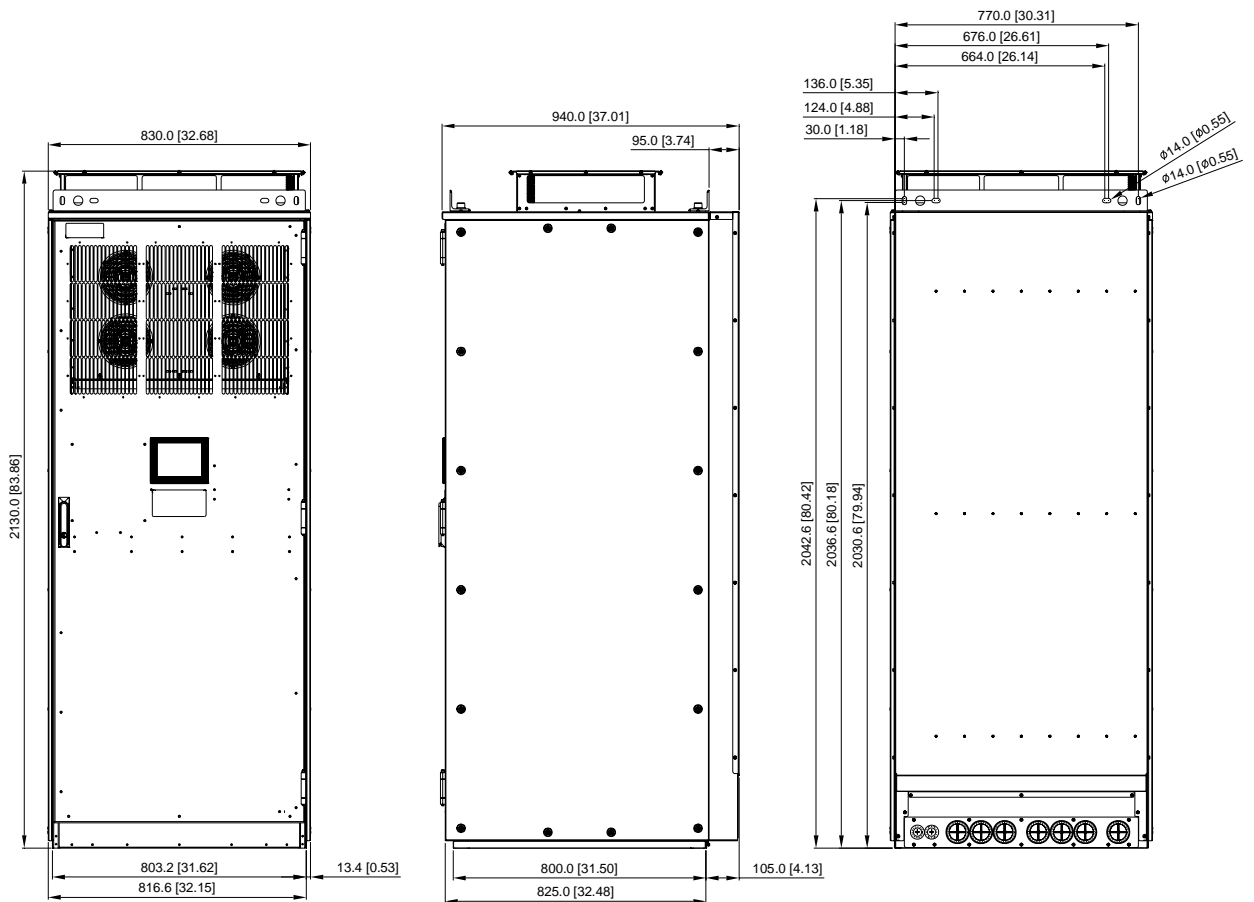

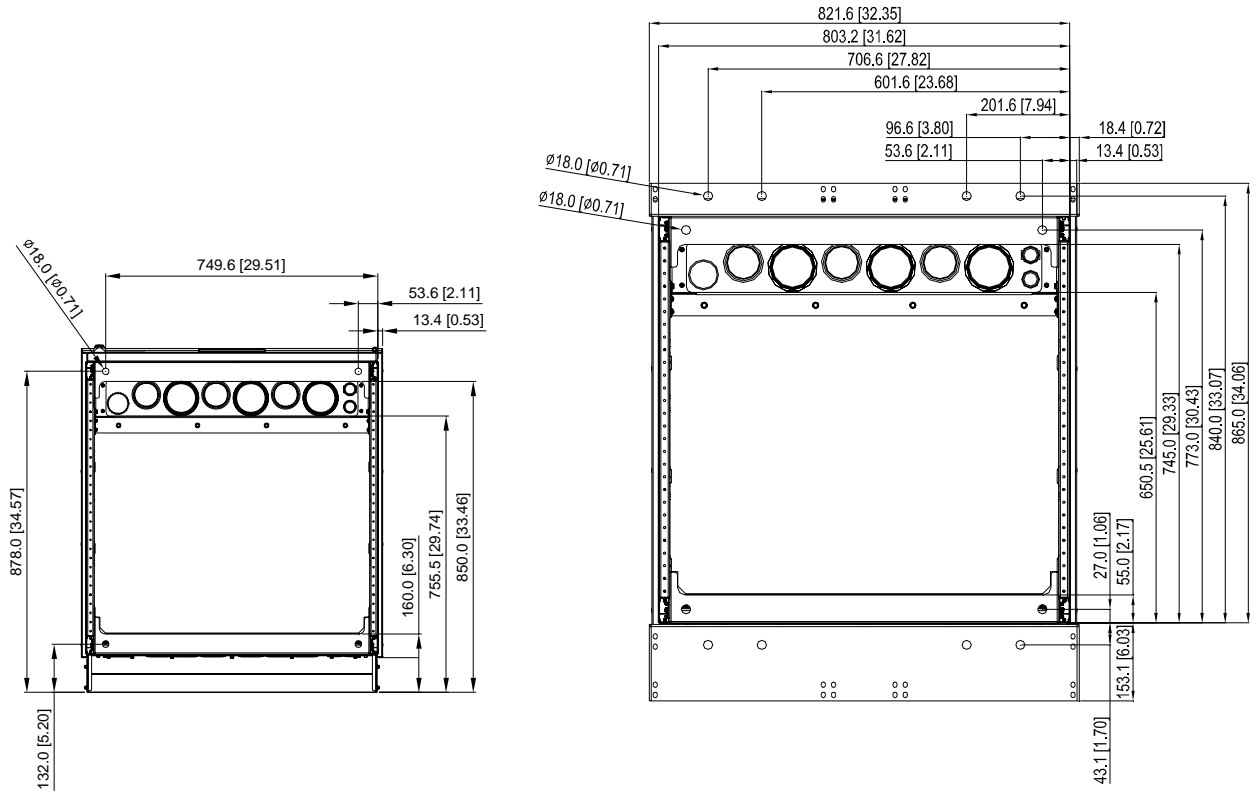

Figure 2-6 Installation dimensions

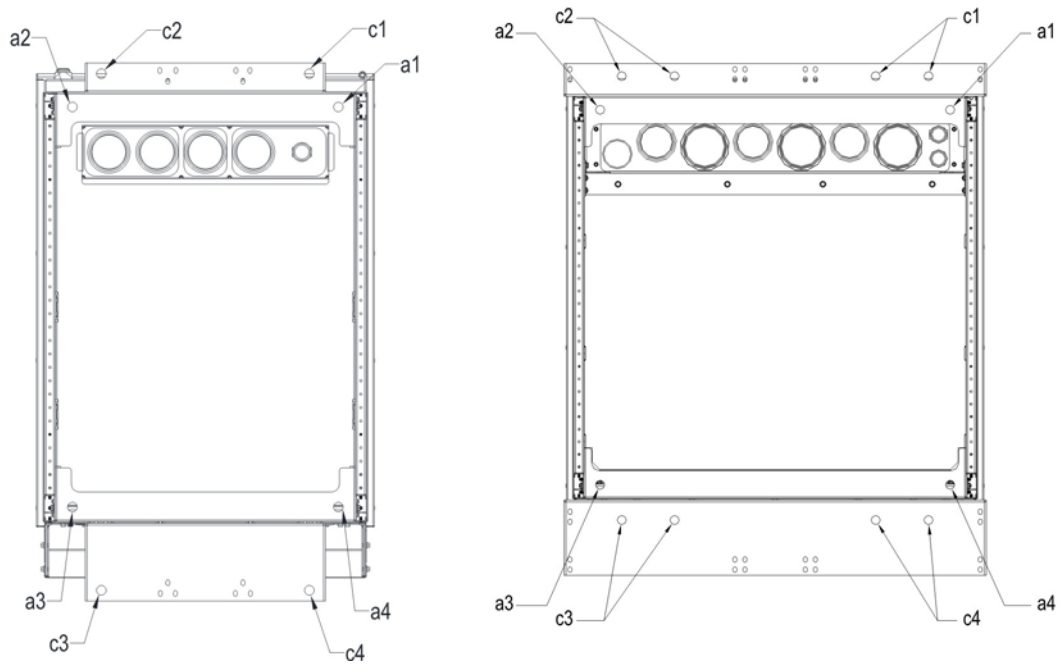
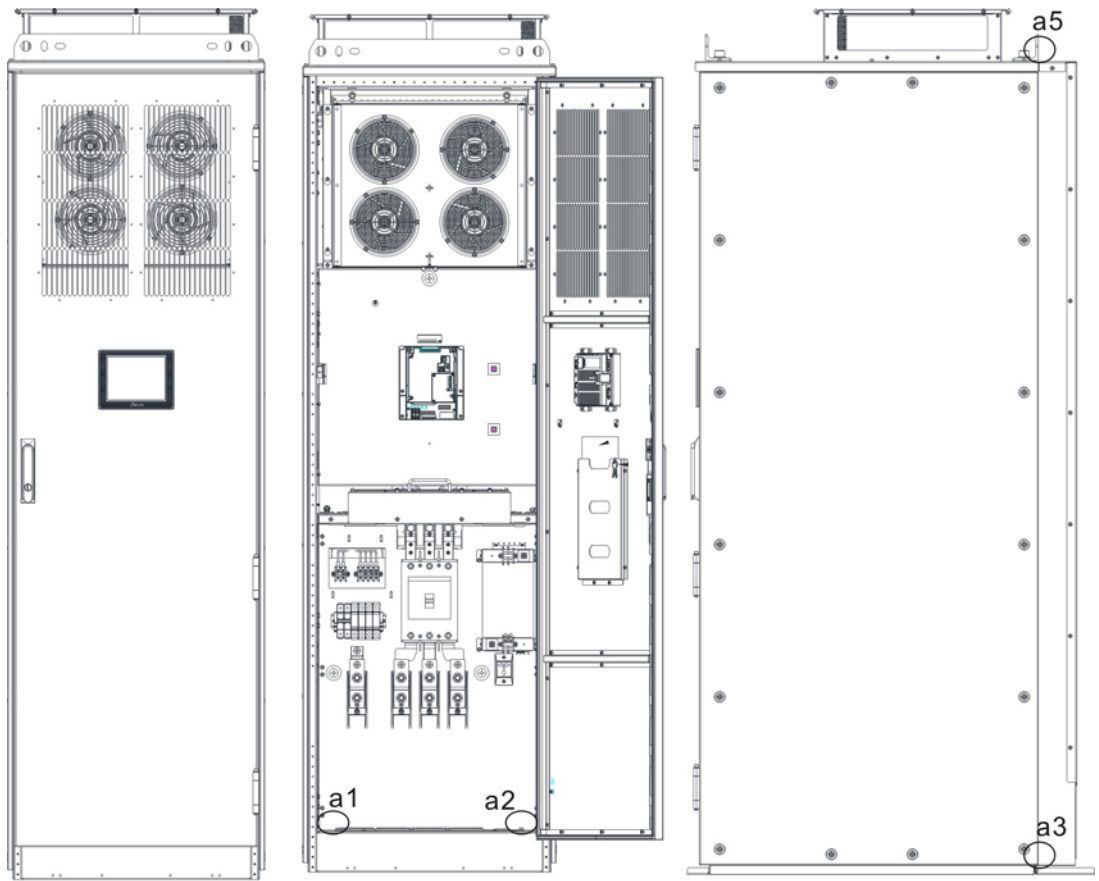

Figure 2-7

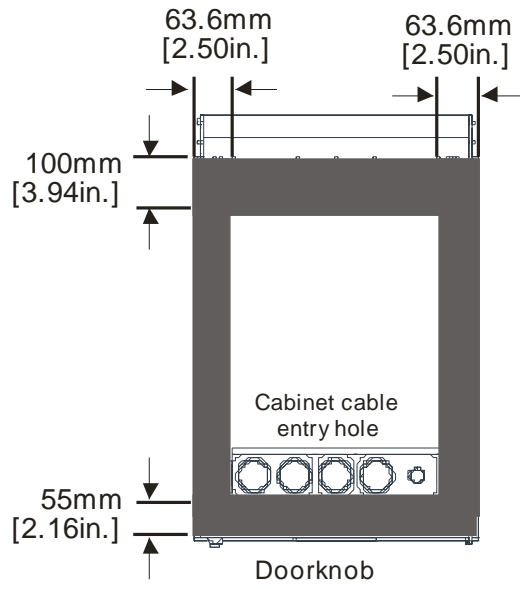

Figure 2-8 Elevated base fixing figure

2-4 Wiring Installation

- Note 1: Please follow local laws and regulations for the wiring electrical regulations of the Static VAR Generator, Delta's Static VAR Generator will only take responsibility for those that comply with local laws and regulations for the wiring electrical regulations, all others are not covered by our warranty.
- Note 2: For DC drives and loads, a 3-phase AC reactor (at least 3%), or an isolated adapter must be installed between the Static VAR Generator's connection points and the load's AC input. Unless the load is a PWM-type drive of the diode rectifier, and integrated into a DC bus reactor, then it can be connected directly with the load's AC input terminals.
- Note 3: Install appropriate overcurrent protection device on top of the mains input distribution panel, the current capacity of the power cable and the system's required overload capacity should be considered when installing. IEC 60947-2 thermal magnetic circuit breaker is generally recommended when using a current of 125%.
- Note 4: For IT power grid systems, a level 4 protection unit must be installed at the Static VAR Generator's external input power distribution and external output power distribution.
- Note 5: When wiring the Static VAR Generator, please be aware that the length of the power cable must not exceed 200M. For other specifications such as the diameter of the cables, please refer to Note 9.
- Note 6: Before wiring, please check the position and status of the switches connecting the Static VAR Generator and mains wirings. Make sure the switches are turned off, and attach warnings to the switches, to prevent others from operating the switches. For details on the maximum current range, please refer to 3-1 Specifications.
- Note 7: [Ground protection wiring] When connecting the cabinet and the main grounding system, the shortest wiring route must be used. The cross-sectional area of the ground wire should be decided based on the level of AC power fault, the length of the power cable, and the type of protection.

Please apply ground fault protection before wiring or turning on the power. Grounding circuits is extremely important; grounding has 3 main purposes:

- A. Electric Shock Prevention: When the insulating equipment deteriorates and becomes damaged, it causes power leakage, rise in electric potential for non-charged metallic parts, or the accumulation of charges in electrical equipment. Providing a low impedance circuit and directing the accumulated charges to the ground, so that the electric potential for non-charged metallic parts approaches the ground electric potential, thus lowering the risk of personnel injuries due to electric shocks.
- B. Fire and Explosion Prevention: Provides enough current carrying capacity, so that faulty circuit wouldn't generate sparks causing fires or explosions due to high impedance leakage. This current carrying capacity must be within the range allowed by the overcurrent protection equipment.
- C. Protective Equipment Activation: Provides a low impedance circuit for faulty current to flow through and activate overcurrent protection equipment or leakage circuit

breakers.

Note 8: Wiring must be completed by a qualified electrician; if you have any questions, please contact your local dealer or Delta Industrial Automation Business Unit immediately. Please tighten the screws securely to prevent loose screws from generating sparks.

Note 9: the following contents are wiring specifications

SVG300 AXXA-11

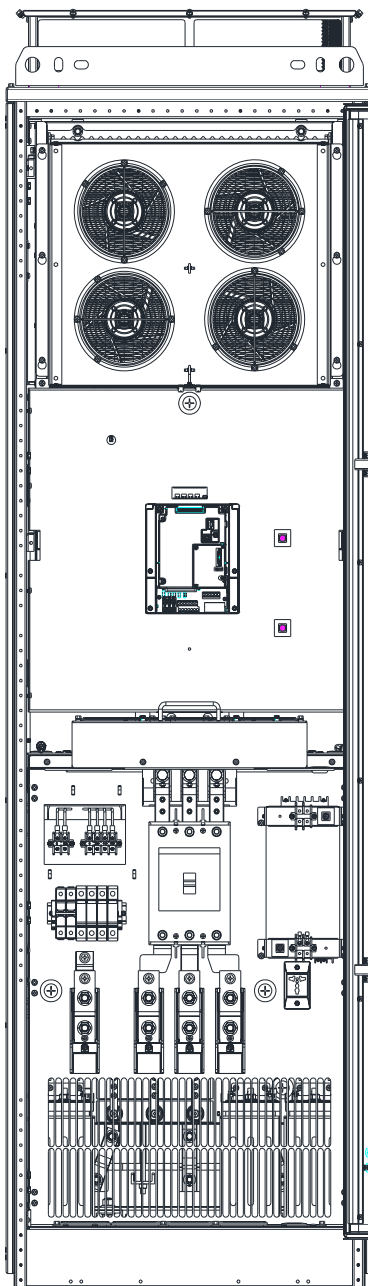

R/L1, S/L2, T/L3, 

Type	Minimum Wire diameter	Torque (±10%)
SVG300A43A-11	4/0AWG (107.2mm ²) *2	400kg-cm (346lb-in)
SVG300A63A-11		(39.2N.m) screw nut M12

UL installation must use 600V, 75 °C or 90 °C wire. Use copper wire only.

Maximum wire diameter for models above: 500Kcmil (253mm²)*2

If users require the use of annular terminals, the terminal specs are shown in figure 2-9.

Figure 2-10 shows the specs of insulated heat shrink tubes that meet the UL standards (600V, YDPU2).

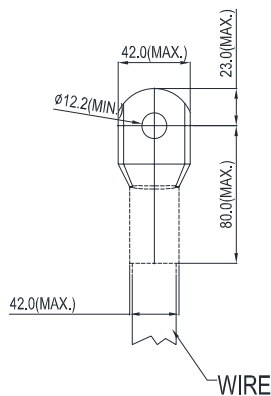

Figure 2-9

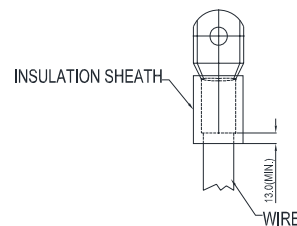
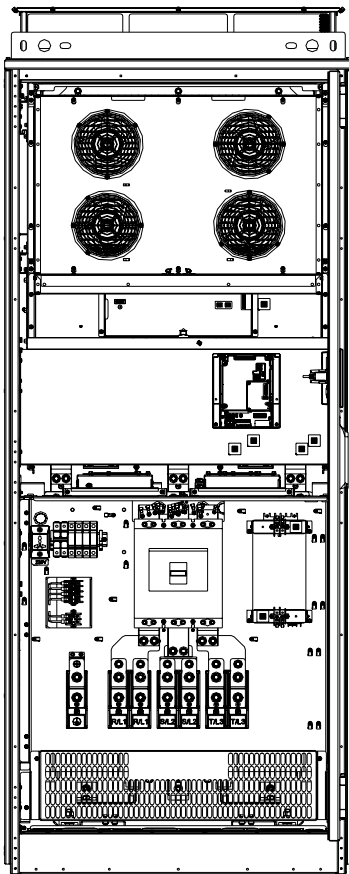

Figure 2-10

SVG500 A43A-11



R/L1, S/L2, T/L3,

Type	Minimum wire diameter	Torque (±10%)
SVG500A43A-11	300Kcmil (152mm ²)*4	400kg-cm (346lb-in) (39.2N.m) screw nut M12
UL installation must use 600V, 75 °C or 90 °C wire. Use copper wire only.		

Maximum wire diameter: 500Kcmil (253mm²)*4



Type	Maximum wire diameter	Torque (±10%)
SVG500A43A-11	500Kcmil (253)*2	400kg-cm (346lb-in) (39.2N.m) screw nut M12
UL installation must use 600V, 75 °C or 90 °C wire. Use copper wire only.		

If a user requires the use of annular terminals, the terminal specs are shown in Figure 2-11.

Figure 2-12 shows the specs of insulated heat shrink tubes that meet the UL standards (600V, YDPU2).

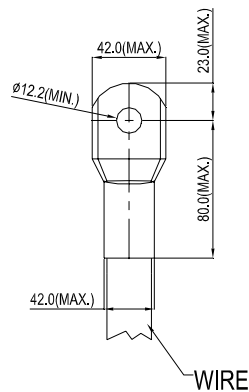

Figure 2-11

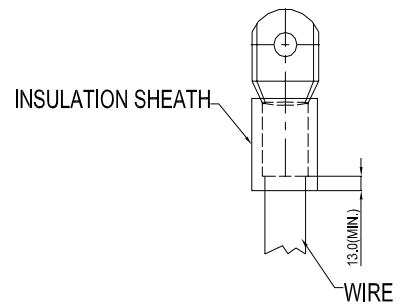
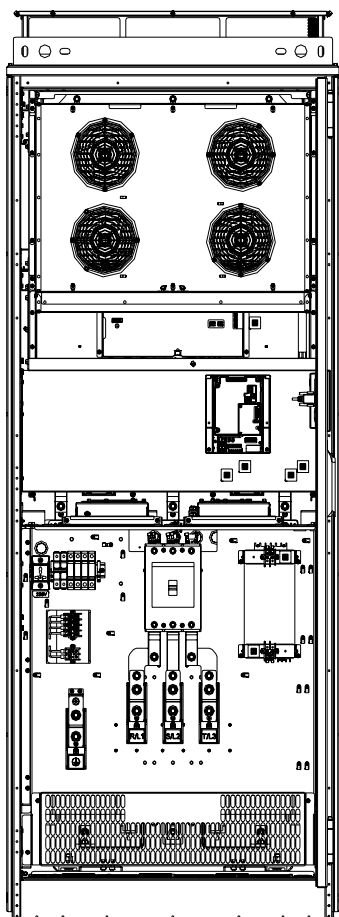

Figure 2-12

SVG500 A63-11



R/L1, S/L2, T/L3,

Type	Minimum wire diameter	Torque (±10%)
SVG500A6A-11	350Kcmil (177mm ²)*2	400kg-cm (346lb-in) (39.2N.m) screw nut M12

UL installation must use 600V, 75 °C or 90 °C wire. Use copper wire only.

Maximum wire diameter: 500Kcmil (253mm²)*2



Type	Maximum wire diameter	Torque (±10%)
SVG500A6A-11	500Kcmil (253)*2	400kg-cm (346lb-in) (39.2N.m) screw nut M12

UL installation must use 600V, 75 °C or 90 °C wire. Use copper wire only.

If a user requires the use of annular terminals, the terminal specs are shown in Figure 2-11.

Figure 2-12 shows the specs of insulated heat shrink tubes that meet the UL standards (600V, YDPU2).

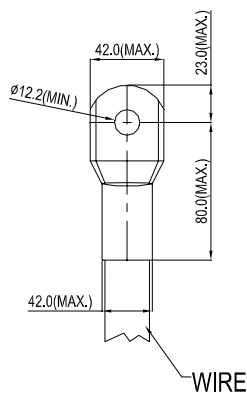

Figure 2-11

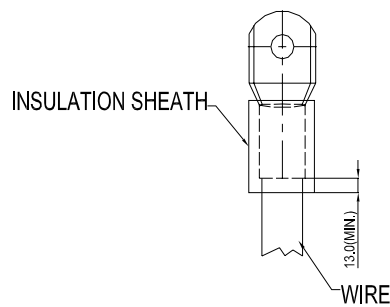

Figure 2-12

Note 10: An external current transformer (CT for short) needs to be connected to the Static VAR Generator, to check the load current waveform. The standard CT's rated frequency of 400Hz (accuracy over 3%) can be used. The CT's rated output current is 5 amps.

Note 12: The phase sequence of CT detection signals (K, L) cannot be swapped, the Static VAR Generator must use 3 CT's in three-phase three-wire devices, installed separately in R-phase, S-phase, and T-phase. The arrows point towards load, the 3 CT's must all be in the same direction, any one in the wrong direction will lead to errors in the detection of current values.

Note 13: When installing CT on a single or on multiple parallel connected Static VAR Generators, it can only be installed on the load side (as shown in figure 2-15).The number of Static VAR Generators connected in parallel is limited to 6.Open circuits on the secondary side are strictly prohibited.

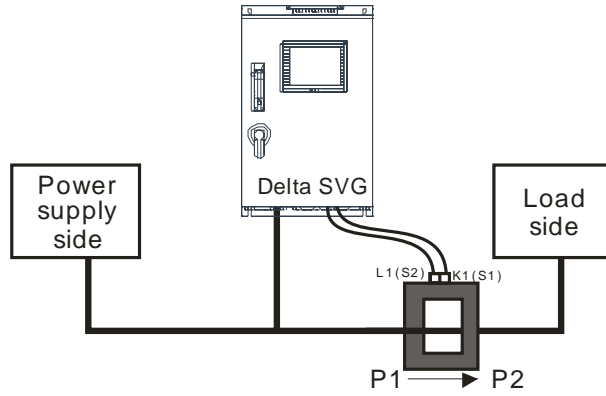

Figure 2-15 CT location schematic diagram

Note 14: If the customer is using phase advancing capacitor cabinets, there are 3 ways to install the CT, as shown in figures 2-16 (a)(b). Note the direction of P1-P2, only 1 CT is shown in the schematic diagram, please refer to 2-4-1 Wiring diagram configuration for actual CT installation.

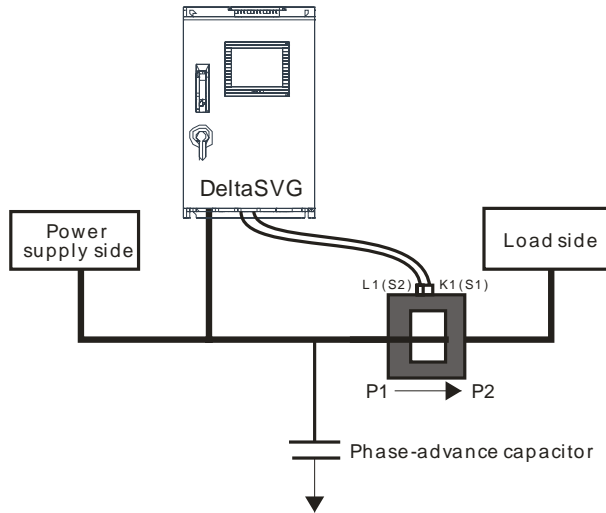

Figure 2-16 (a)

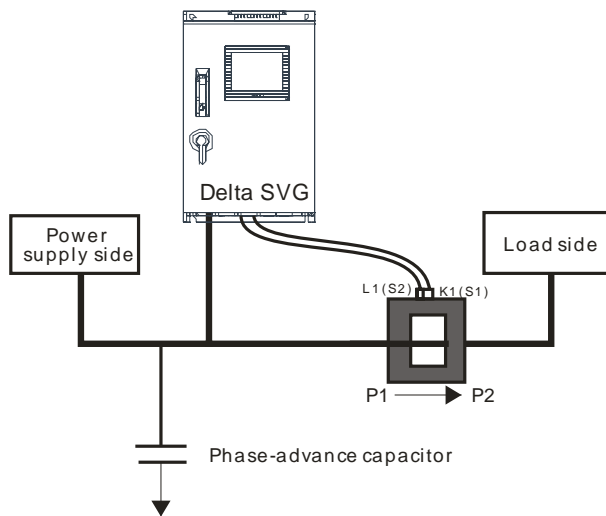
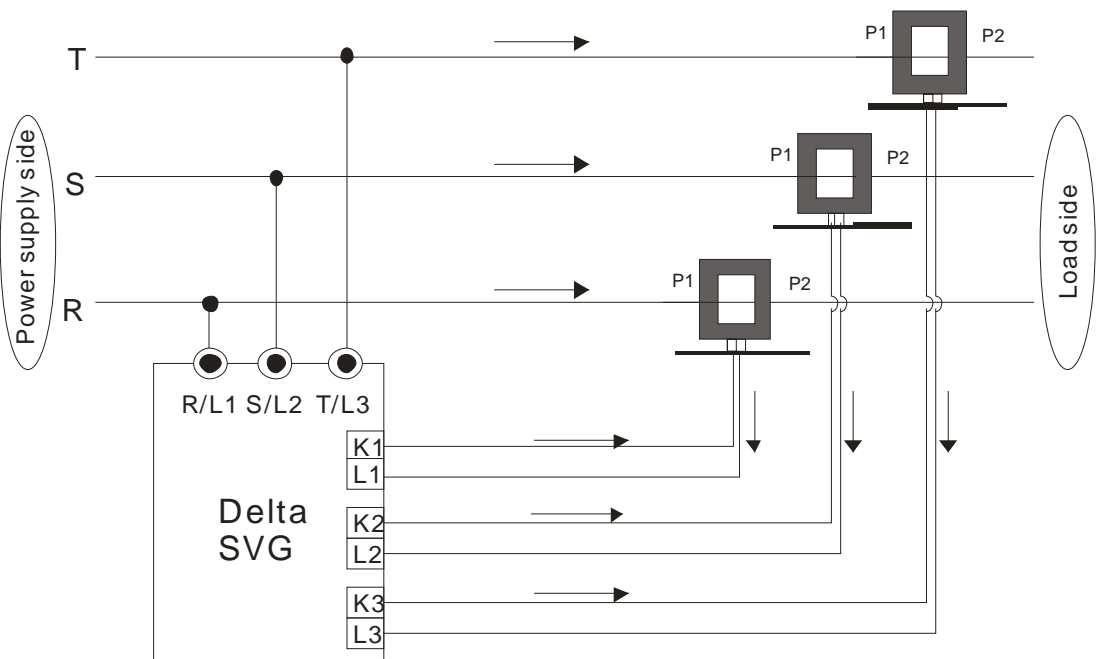

Figure 2-16 (b)

2-4-1 Wiring

- ☑ Before wiring the main circuit, make sure the power grid and the Static VAR Generator have the same phase sequence, otherwise the Static VAR Generator may not function correctly. Open circuit on the secondary side is strictly prohibited, and the power cable for the main circuit must not exceed 200M.
- ☑ The number of Static VAR Generators connected in parallel is limited to 6.
- ☑ The current transformer may only be installed on the load side. Pay attention to the direction of positions P1→P2 when installing.
- ☑ Please use shielded twisted pair or shielded cable when wiring the current transformer. For detailed cable specs, please refer to 3-2-1 Current transformer.

(1) Single Power Active Filter (SVG)+ current transformer (CT)



(2) Multiple Power Active Filters (SVG)+ current transformer (CT)

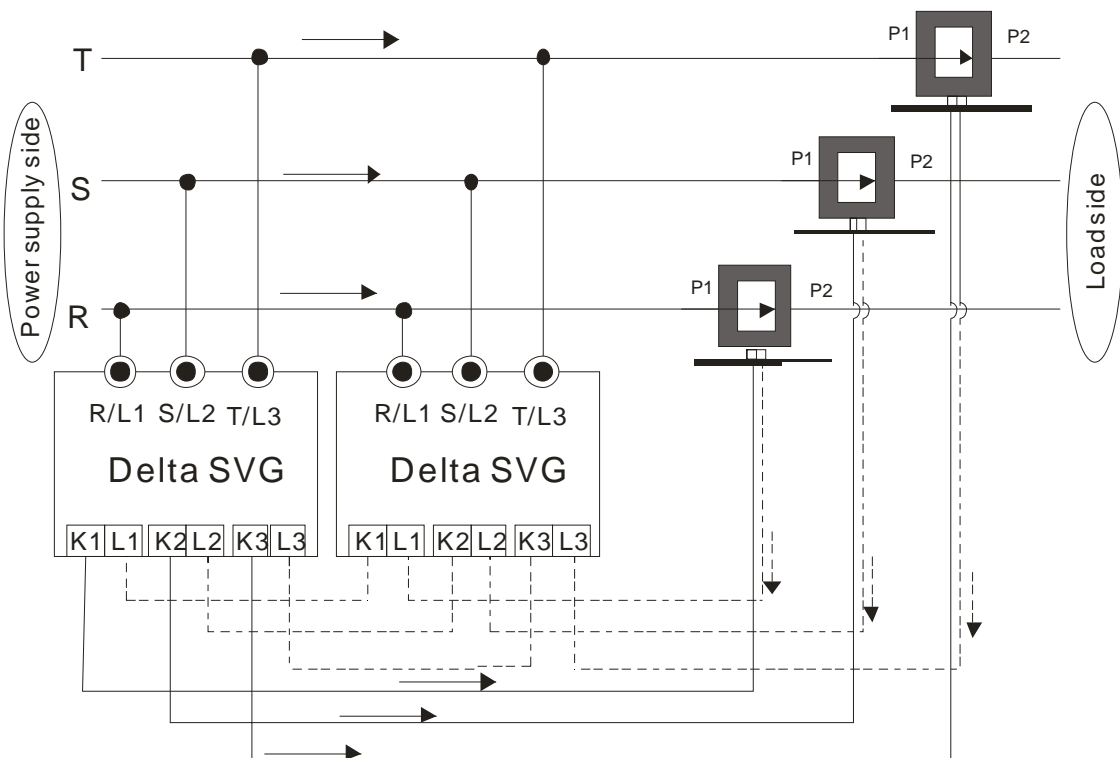

2-5 Outer appearance dimensions

SVG300A43A-11; SVG300A63A-11

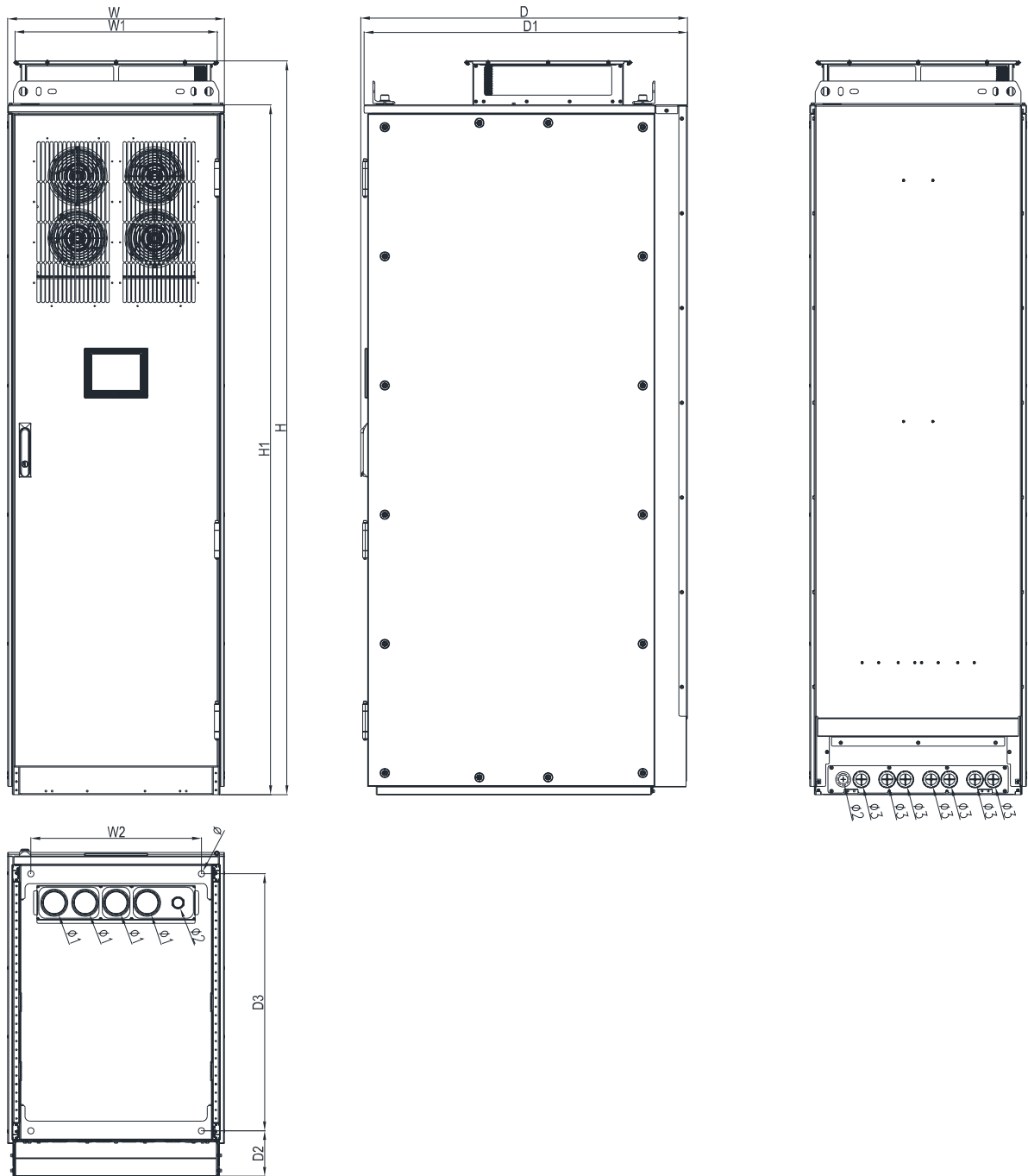

Unit: mm[inch]

W	W1	W2	H	H1	D	D1	D2	D3	Ø	?1	?2	?3
630.0	588.4	496.0	2130.0	2002.0	950.0	940.0	132.0	746.0	18.0	74.0	34.0	43.8
[24.80]	[23.16]	[19.53]	[83.86]	[78.82]	[37.40]	[37.01]	[5.20]	[29.37]	[0.71]	[2.91]	[1.34]	[1.72]

SVG500A43A-11; SVG500A63A-11

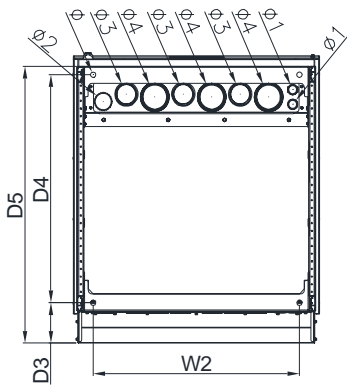
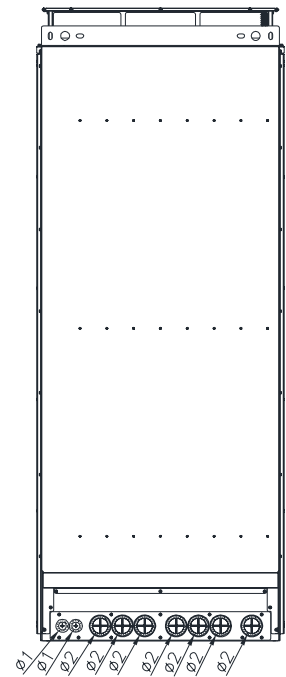
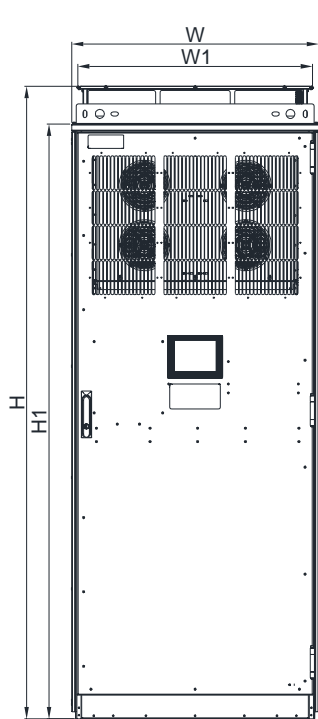
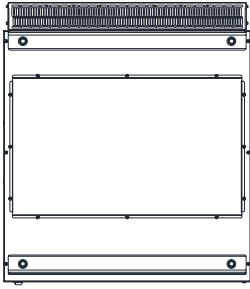

Unit: mm[inch]

Frame	W	W1	W2	H	H1	D	D1	D2
B1	830.0 [32.68]	788.4 [31.04]	696.0 [27.40]	2130.0 [83.86]	2002.0 [78.82]	845.0 [33.27]	940.0 [37.01]	950.0 [37.40]
Frame	D3	D4	D5	Ø	?1	?2	?3	?4
B1	132.0 [5.20]	746.0 [29.37]	905.0 [35.63]	18.0 [0.71]	74.0 [2.91]	34.0 [1.34]	43.8 [1.72]	92.0 [3.62]

03 Specifications

3-1 Specifications Table

Basic specifications

Product model number		SVG300A43A-11	SVG500A43A-11	SVG300A63A-11	SVG500A63A-11
Frame		A	B	A	B
Output	Rated offset capacitance (kVAR)	300	500	300	500
	Rated offset current (Amp)	433	722	290	420
	Current limit	Nominal Current			
	Carrier frequency	4kHz			
Input	Voltage / frequency rating	3-Phase 200~480Vac -15~+10%		3-Phase 525~690Vac -15~+10%	
	Operating voltage	170~528Vac		446~759Vac	
	Rated frequency	50/60Hz			
	Allowed power frequency range	47-63Hz			
Overall performance		97%			
Compensation range		-1~1, capacitive to inductive continuously adjustable, and quickly switchable			
Fast response time		300us			
Full response time		20ms			
Communication interface		RS485, Ethernet interface			
Communication protocol		Modbus protocol, general power protocol			
Installation method		Cabinet			
Cable entry method		Lower / upper cable entry			
Cooling mode		Intelligent cooling			
Number of parallel units		2~6 units			
CT range		150/5-10000/5			
Noise level		75dBA	75dBA	75dBA	75dBA
Dimensions mm (width x height x depth)		630 x 2130 x 950	830 x 2130 x 950	630 x 2130 x 950	830 x 2130 x 950
Weight		650kg±10%	1100kg±10%	650kg±10%	1100kg±10%
Protection level		IP21(NEMA1)			
International certifications		CE, UL, cUL, C-Tick			

Environment characteristics

Ambient temperature	-10°C ~ +45°C for SVG300AXXA-XX, SVG500A43A-XX -10°C ~ +40°C for SVG500A63A-XX	
Installation location	IEC60364-1/IEC60664-1 Pollution degree 2, Indoor use only	
Ambient temperature	Storage / transportation	-25°C ~ +70°C

Rated humidity	Operation	Max. 90%
	Storage / transportation	Max. 95%
Atmospheric pressure	Operation / Storage	86 to 106 kPa
	Transportation	70 to 106 kPa
Pollution level	IEC721-3-3	
	Operation	Class 3C2; Class 3S2
	Storage	Class 2C2; Class 2S2
	Transportation	Class 1C2; Class 1S2
Height	Operation	0-1000 meters: rated capacity use 1000-3000 meters: using 1000 meters as the base, for every 200m increase in altitude, decrease rated current by 2%, or lower the operating ambient temperature by 0.5°C. Corner Grounded systems can only be operated at altitudes below 2000m.
Temperature derating (maximum 50°C) (as shown in Table 1)	45°C and above, each 1°C output current is derated 2% for SVG300A43A, SVG300A63A, SVG500A43A	
	40°C and above, each 1°C output current is derated 2% for SVG500A63A, as shown in Table 1	
If the applicable environment is: dusty, sunlit, filled with corrosive or flammable gases, greasy, damp, dripping, turbulent, the salt concentration in the air is at least 0.01mg/cm ² or for other harsh environments, cabinets with higher IP level will need to be ordered.		

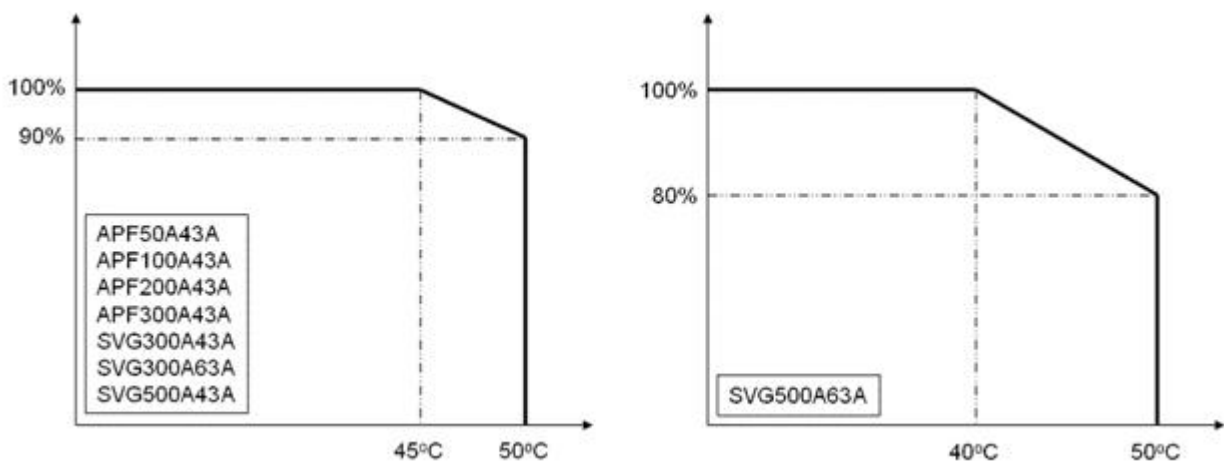

Table 1

3-2 Optional Accessories

3-2-1 Current Transformer

Delta's Static VAR Generator requires 3 current transformers (or CT), which use the rated frequency for standard transformers of 400Hz (precision better than 1%); CT's rated output value must be 5A. Users can select suitable CT from table 3-1 CT model selection to install.

Notes on CT model selection:

- (1) Be aware of the installation direction when installing CT's. The phase sequence of CT detection signals (K, L) cannot be swapped, the Static VAR Generator must use 3 CT's in three-phase three-wire devices, installed separately in R-phase, S-phase, and T-phase. The arrows point towards load. The 3 CT's must all be in the same direction, any fixed in the wrong direction will lead to errors in the detection of current values.
- (2) The ratio of rated primary / secondary current must be selected reasonably, the recommended primary current is 1.2-times (actual rated current);
- (3) The primary / secondary isolation voltage is 0.66V; select 5A as the secondary current;



Magnified figure of the terminals (*3)

Model	Current ratio (A)*1	Primary current (A)	Secondary Output power (VA)	Accuracy	Dimension code	Dimension (mm)	
CT-A0300	300A/5A	300	2.5VA	1%	A	Outer frame	115*110*46
						Inner frame	51*50*32
CT-A0600	600A/5A	600	5VA	1%	A	Outer frame	115*110*46
						Inner frame	51*50*32

Model	Current ratio (A)* ¹	Primary current (A)	Secondary Output power (VA)	Accuracy	Dimension code	Dimension (mm)	
						Inner frame	
CT-B0300	300A/5A	300	5VA	0.50%	B	Outer frame Inner frame	155*110*46 51*50*32
CT-B0600	600A/5A	600	5VA	0.50%	B	Outer frame Inner frame	155*110*46 51*50*32
CT-B0800	800A/5A	800	5VA	0.50%	B	Outer frame Inner frame	155*110*46 51*50*32
CT-B1000	1000A/5A	1000	5VA	0.50%	B	Outer frame Inner frame	155*110*46 51*50*32
CT-C0300	300A/5A	300	5VA	1%	C	Outer frame Inner frame	186*110*46 121*50*32
CT-C0500	500A/5A	500	5VA	0.50%	C	Outer frame Inner frame	186*110*46 121*50*32
CT-C0800	800A/5A	800	5VA	0.50%	C	Outer frame Inner frame	186*110*46 121*50*32
CT-C1000	1000A/5A	1000	5VA	0.50%	C	Outer frame Inner frame	186*110*46 121*50*32
CT-C1200	1200A/5A	1200	5VA	0.50%	C	Outer frame Inner frame	186*110*46 121*50*32

Model	Current ratio (A)* ¹	Primary current (A)	Secondary Output power (VA)	Accuracy	Dimension code	Dimension (mm)	
						Outer frame	Inner frame
CT-C1500	1500A/5A	1500	5VA	0.50%	C	186*110*46	121*50*32
CT-C1800	1800A/5A	1800	5VA	0.50%	C	186*110*46	121*50*32
CT-C2500* ²	2500A/5A	2500	5VA	0.50%	C	186*110*46	121*50*32
CT-D1200	1200A/5A	1200	5VA	0.50%	D	226*130*46	161*70*32
CT-D1500	1500A/5A	1500	5VA	0.50%	D	226*130*46	161*70*32
CT-D1800	1800A/5A	1800	5VA	0.50%	D	226*130*46	161*70*32
CT-D2000	2000A/5A	2000	5VA	0.50%	D	226*130*46	161*70*32
CT-D3000	3000A/5A	3000	5VA	0.50%	D	226*130*46	161*70*32

Table 3-1 CT Model selection table

*¹. When selecting CT's, pick the model with current closest to the actual primary current value (peak rms current).

For example: If the actual current is 280A, please select model: CT-A0300 as it's most suitable. The same logic applies to the rest.

*². Model CT-C2500 does not have UL certificate. All other models are UL certified.

*3. CT signal detection terminal, (K, L) labeled in the figure, is removable so that customers can easily replace the wiring.

(4) Crimp terminal connectors must be used for CT's terminal lines, and securely tightened K(S1), L(S2) terminal wirings

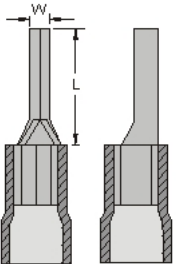
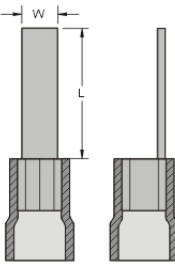
Terminal:	K1,L1, K2,L2, K3,L3,	
Wire diameter	24~10AWG	
Applicable terminal block (used with figure 3-1 position A)	Pin insulated terminal	Blade insulated terminal
	 <p>W: 2.7mm L: 14mm</p>	 <p>W: 2.8mm L: 10mm</p>

(5) There is a limit on the length of CT cable; cables that are too long will cause the CT to decrease in accuracy.

(6) When installing multiple parallel units, the length of each CT cable must be identical.

CT cable selection

wire gauge(mm ² /AWG)	Impedance (Ω)	Cable length (meters/feet)	Minimum load required by CT (VA)	Recommendation
4/#12	5.1	50/164	>6.3	10VA
6/#10	3.4	50/164	>4.2	7.5VA

The formula for the CT's fixed maximum load is: cable length (M) = [(VA)-1.25] / [25*(ohm/M)]

(VA): 25*(ohm/M)* M+1.25; (ohm/M): impedance

Range of cable length

wire gauge(mm ² /AWG)	Impedance (Ω)	Cable length (meters/feet)	Minimum load required by CT (VA)
6/#10	3.4	<44m/ 147	5
6/#10	3.4	<73m/ 243	7.5
6/#10	3.4	<102m/ 340	10
6/#10	3.4	<161m/ 537	15
6/#10	3.4	<338m/ 1127	30
4/#12	5.1	<29m/ 97	5
4/#12	5.1	<49m/ 163	7.5
4/#12	5.1	<68m/ 227	10
4/#12	5.1	<107m/ 357	15
4/#12	5.1	<225m/ 750	30

3-3 Control terminal description

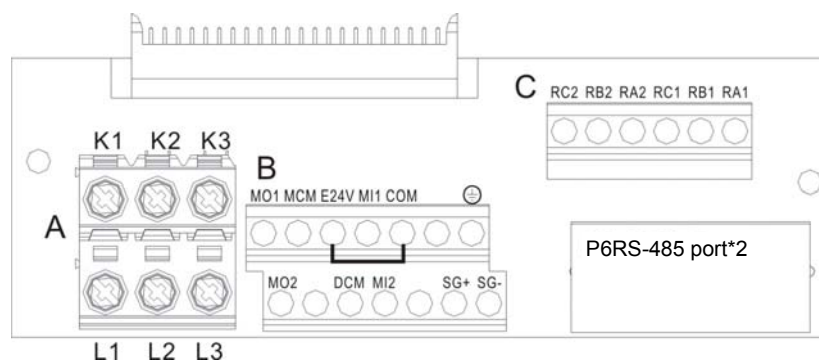

Figure 3-1 Control terminal location

Position	Suitable wire size	Torque
A	24~10AWG	14.3Kg-cm(12.41 lb-in) (1.4N.m)
B	26~16AWG	8Kg-cm(6.94 lb-in) (0.78N.m)
C		5Kg-cm(4.3 lb-in) (0.49N.m)

Wiring precautions:

Place the wires into the wiring hole and tighten the wirings with a flathead screwdriver, note that it is best to leave 5mm spacing at the wiring end. Note [using wirings without terminal blocks and place the wires neatly into the wiring hole] only applies to specific positions (terminals B, C in the figure above).

Terminal	Description of Function	Factory setting (NPN mode)
E24V	Common terminal for digital control signals (Source)	E24V±5% 100mA Factory setting E24V-COM short circuit
COM	Common terminal for digital control signals (Sink)	Common terminal for multi-function input
MI1	Multi-function input terminal	None (factory default), RUN/STOP, EF1. RESET*
MI2	Multi-function input terminal	None (factory default), RUN/STOP, EF1. RESET*
RA1	Multi-function output contact 1 (Relay normally open a)	Resistive load 5A(N.O.)/3A(N.C.) 250VAC;
RB1	Multi-function output contact 1 (Relay normally closed b)	5A(N.O.)/3A(N.C.) 30VDC Inductive load (COS 0.4)
RA2	Multi-function output contact 2 (Relay normally open a)	2.0A(N.O.)/1.2A(N.C.) 250VAC; 2.0A(N.O.)/1.2A(N.C.) 30VDC
RB2	Multi-function output contact 2 (Relay normally close b)	Outputs various monitoring signals, such as in operation (Running), in preparation (PLL OK), error display, warning
RC1	Multi-function output contact 1 common terminal (Relay 1)	display, and standby ready Factory default: none
RC2	Multi-function output contact 2 common terminal (Relay 2)	

MO1	Multi-function output terminal 1 (Optic coupler)	Outputs various monitoring signals, via transistor (open collector).Such as in operation (Running), in preparation (PLL OK), error display, warning display, standby ready, factory default: none
MO2	Multi-function output terminal 2 (Optic coupler)	
MCM	Multi-function output common terminal (Optic coupler)	Max 48Vdc 50mA
K1	CT1~CT3 Output / Input signal contacts	Can use 3 current transformers (CT) Current transformer is an accessory (necessary accessory); it can also be purchased and installed on your own. Be aware of the installation direction when installing CT's, models purchased elsewhere may have labels S1, S2 =K, L (Delta equivalent)
L1		
K2		
L2		
K3		
L3		
SG+	Modbus RS-485	
SG-	PIN 3: GND; PIN 4: SG-; PIN 5: SG+	

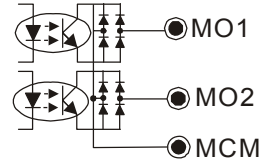

3-4 Lightning Protection Module

Lightning protection modules used by the full range of Static VAR Generators have the same specifications, with the following characteristics:

Lightning protection module specifications

FOR SVGXXXA43A-XX

Powering system		TT-TN
Rated operating voltage Un (V)		380
Maximum continuous operating voltage Uc (V)		385
Standard discharge current In (8/20)KA	L-N	20
	N-PE	20
Maximum discharge current I _{max} (8/20)KA	L-N	40
	N-PE	40
Voltage protection level [L-N] Up (KV)		1.6
Voltage protection level [N-PE] Up (KV)		1.2
Circuit breaker		Internal
Internal overcurrent circuit breaker		Internal
Protection level		IP20
Temperature range		-40~+85°C
Relative humidity		≤95%
Contact performance		150Vdc/2A
Altitude		3000m

FOR SVGXXXA63A-XX

Powering system		TT-TN
Rated operating voltage Un (V)		510
Maximum continuous operating voltage Uc (V)		690
Standard discharge current In (8/20)KA	L-N	20
	N-PE	20
Maximum discharge current I _{max} (8/20)KA	L-N	40
	N-PE	40
Voltage protection level [L-N] Up (KV)		2.5
Voltage protection level [N-PE] Up (KV)		1.2
Circuit breaker		Internal
Internal overcurrent circuit breaker		Internal
Protection level		IP20
Temperature range		-40~+85°C
Relative humidity		≤95%
Contact performance		150Vdc/2A
Altitude		3000m

3-5 Fans

Type	Fans model number	Number of fans
SVG300A43A-11	AHB1748EHG	5
SVG500A43A-11	AHB1748EHG	7
SVG300A63A-11	AHB1748EHG	7
SVG500A63A-11	AHB1748EHG	7

Fans specifications

Rated voltage	48Vdc
Operating voltage	38.0~56.0Vdc
Input current	1.30A (Max. 1.46A)
Speed	4800±10% R.P.M.
Noise level	64.0dB-A
Installation level	Complies with UL: CLASS A

3-6 Transformer

When adjusting the transformer, please note the following points in order to ensure safe use

- 1) When adjusting the voltage range of the transformer, make sure the voltage range is the same as the voltage of the Static VAR Generator's main circuit
- 2) When the transformer is not properly wired, do not start the Static VAR Generator
- 3) When the main circuit terminal of the Static VAR Generator is powered, please do not directly adjust the voltage range of the transformer to avoid danger
- 4) Refer to "Voltage adjustment steps" for instructions on adjusting the transformer

For SVGXXXA43A-XX

Rated primary voltage / frequency: 380/440/480Vac±10% 50Hz/60Hz

Rated secondary voltage / frequency: 230Vac±10% 50Hz/60Hz

Winding	Circuit Description	Rated Current
PRI.	0/380/440/480V	3.93A
SEC.	0/230V	6.5A

Meets EN61558; CLASS F (155°C)

Voltage ranges for adapters:

Input voltage
200 ~ 230Vac±10%
380Vac±10%
440 Vac±10%
480 Vac±10%

For SVGXXXA63A-XX

Rated primary voltage / frequency: 525/575/690Vac±10% 50Hz/60Hz

Rated secondary voltage / frequency: 230Vac±10% 50Hz/60Hz

Winding	Circuit Description	Rated Current
PRI.	0/525/575/690V	2.16A
SEC.	0/230V	6.5A

Meets EN61558; CLASS F (155°C)

Voltage ranges for adapters:

Input voltage
525Vac±10%
575Vac±10%
690Vac±10%

Table 3-2 Voltage ranges

Voltage adjustment steps

- (1) Verify the voltage of the input power, before adjusting the SVG's voltage. The factory settings for the Static VAR Generator are:
380Vac for SVGXXXA43A-XX models;
690Vac for SVGXXXA63A-XX models.
- (2) We provide 230V/380V/440V/480V/525V/575V/690V voltages for selection. Users can select suitable voltages for their own equipment. Please refer to table 3-2 Voltage range. Please refer to the dashed lines in Figure 3-2 for wiring methods.
- (3) Before adjusting voltage, remove the transparent top cover and start wiring. After wiring is complete, be sure to return the transparent top cover to its original position. Screw M4: torque: 11.2 to 13.3 kg-cm [9.72 to 11.54lb.in] (1.1 to 1.3N.m).

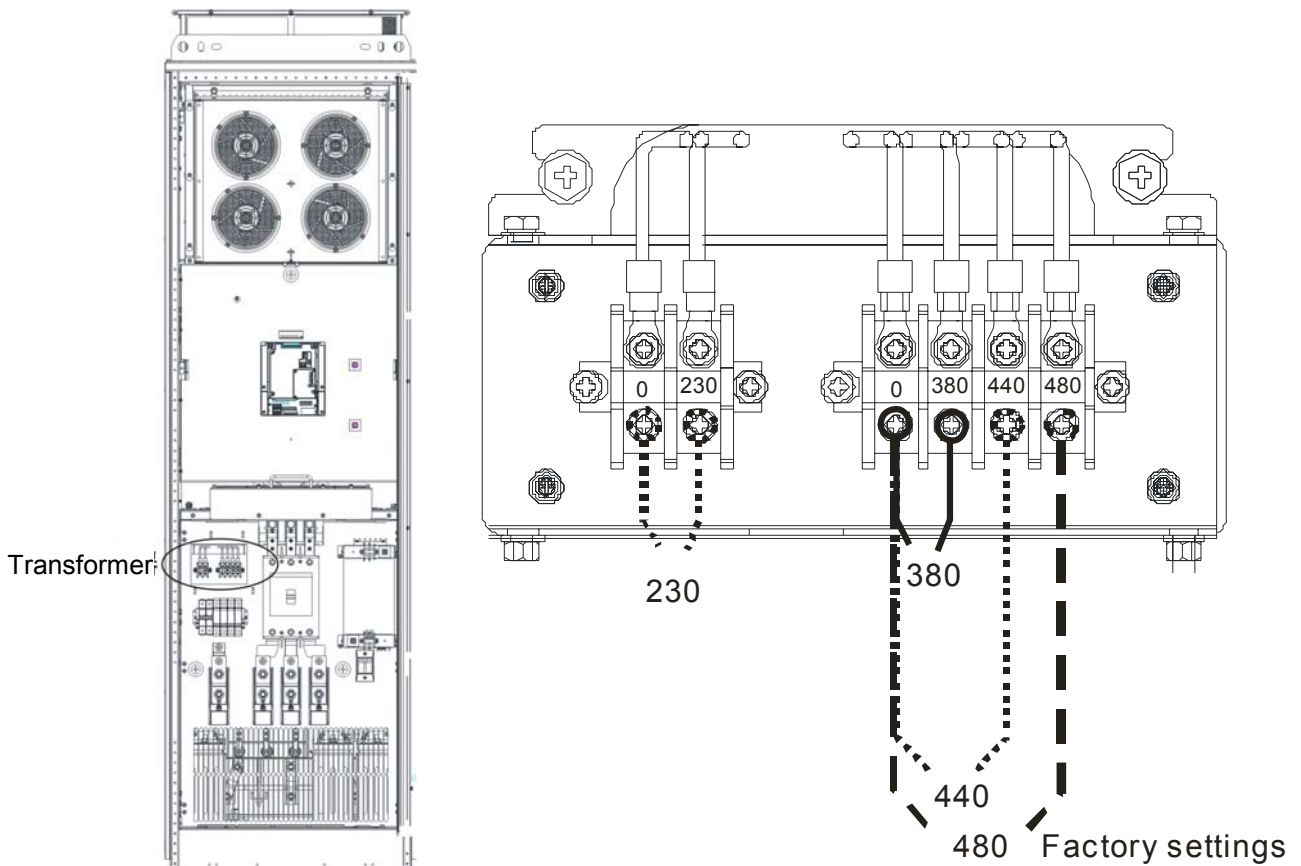

Figure 3-2 Transformer adjustment

3-7 AC/DC Power Source

	Model	SE-600-48
Output	DC voltage	48V
	Rated current	12.5A
	Current range	0~12.5V
	Rated power	600W
	Ripple and noise	200mVp-p
	Voltage adjustment range	43~56V
	Voltage precision	±1.0%
	Line regulation	±0.5%
	Load regulation	±0.5%
	Power up, rise time	1000ms, 50ms/230Vac; 1000m, 50ms/115Vac (full load)
	Hold time (Typ.)	20ms/230Vac 16ms/115Vac (at full load)
Input	Voltage range	90~132Vac/180~264Vac (switch on/off) or 254~370Vdc
	Frequency range	47~63Hz
	Efficiency (Typ.)	88%
	AC current (Typ.)	12A/115Vac 7.5A/230Vac
	Inrush current (Typ.)	30A/115Vac 60A/230Vac
	Leakage current	<2.0mA/240Vac
Protection	Overloaded	105%~125% of rated output power Protection mode: output shuts off and restores after restarting
	Overvoltage	57.6 to 67.2V Protection mode: output shuts off and power can be restored after restarting
	Over temperature	85°C ± 5°C (TSW1: heat sink that checks the power transistor) Protection mode: output shuts off and is automatically restored after the temperature returns to normal
Environment	Operating temperature	-20~+60°C
	Operating humidity	20~90% RH, no condensation
	Storage temperature, humidity	-40~+85°C, 10~95%RH
	Temperature coefficient	±0.05%/°C (0~50°C)
Safety regulation		UL60950-1

04 Power Quality Management System

After starting up the Active Power Filter, the power quality management system will activate within 15 seconds, it will complete initialization and display the startup screen within 15 seconds, and then enter the main screen.

The power quality management system uses a 7 inch (800*600) TFT LCD full color touch screen that can continuously monitor and read three-phase waveform data from the grid, load, and the output side of the Active Power Filter in real time, has password protection, supports multilingual display, store as many as 100 sets of error logs, export data history for management, support SD card and Ethernet monitoring and management.

Before start using, please note the following points:

- The screen is touch-sensitive, when using the touch screen, please do not use sharp tools to operate the screen.
- While in use, if the screen needs to be cleaned, please wipe the screen with specialized cloth and cleaning fluid to keep the screen clear.
- The power quality management system has a power saving feature, in operation, if the system is idle for more than the preset duration of 10 minutes, it will automatically enter hibernation mode and turn off the screen. The display will return when touching the screen once and can be operated afterward. The hibernation time can be adjusted, the factory default is 10 minutes. To adjust the hibernation time, refer to [Language/Time] function setting.
- Delta power quality management system, has password protect control, users need to set the password, before they can set various functions. For more details on passwords, please refer to 4-3-1 Quick start.
- The power management system currently supports Traditional Chinese, Simplified Chinese, and English.

This chapter uses screenshots from v1.04 for description purposes. If the following figures are different from those on your actual device, please refer to your actual device. Please contact Delta's factory personnel for assistance with any related problems.



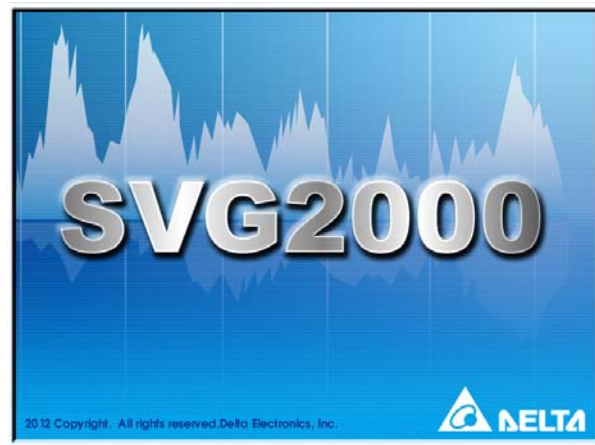

4-1 Main Screen Introduction



4-1-1 Startup screen



4-1-2 Main screen description

1 System status bar
2 Setting icons
3 Function status area

Item	Description		
1	System status bar	Model	Displays the model number of the model in use (SVGXXXAXXA-XX)
		Capacity	Displays the capacity of the model in use (A)
		Frequency	Displays the frequency of the model in use (Hz)
		Usage	Displays the output usage of the model in use (%)
2	Setting icons		Displays various function settings, for more details refer to 4-3 Detailed Descriptions of Function Settings
			When a warning message is displayed, the warning message can be disabled using the screen.
			Displays the current boot method as: "Auto" or "Manual" mode.
			Return to main screen
			Startup (ON/OFF) icon; a green light means the system is running, a red light means the system is off

Item		Description
		Displays the menu in use, the factory default date and time; the display changes as the menu in use changes
		Displays various operating instructions, language switching function, and quick browse function
		Screen Lock: Click once to unlock it.
3	Function status area	Displays detailed settings for the function in use and changes as the function in use changes

4-1-3 Operation Interface Description

A variety of expansion interfaces, supporting RS-232/422/485, Ethernet, USB drives, and SD cards. Users can use remote monitoring through a network port (LAN), refer to "4-3-6 System Status" for detailed instructions on remote control.

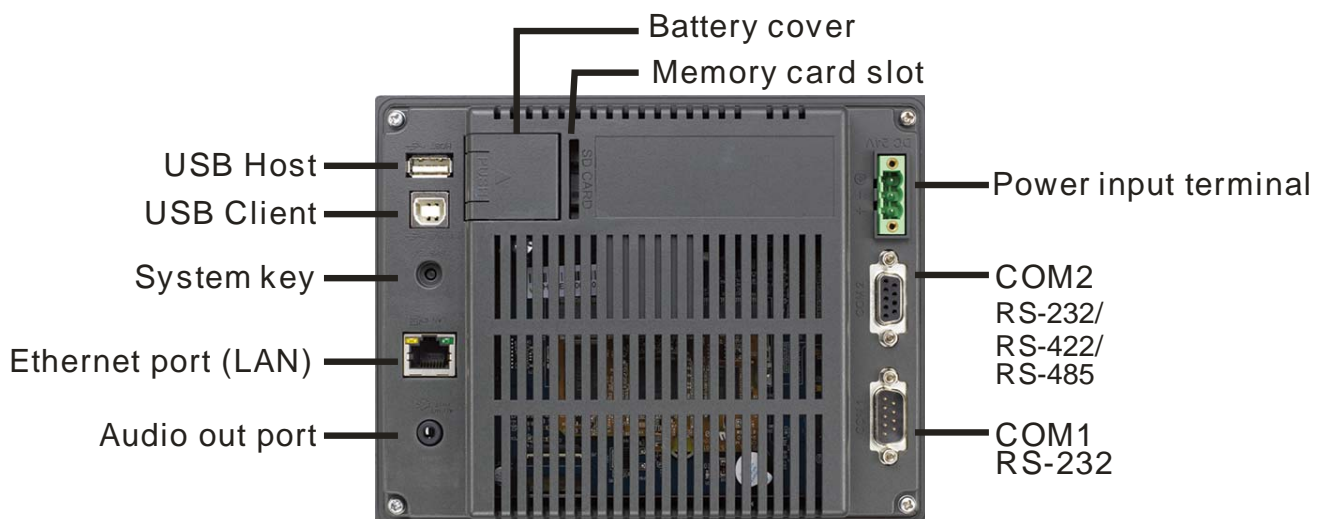

Waterproof panel rating: IP65/NEMA4

Resolution: 800*600 pixels

Panel type: 7" TFT LCD (65,536 colors)

Back light: LED Back Light (At 25°C half life > 10,000 hours)

Cooling: Natural cooling

Memory Backup Battery: 3V Lithium Battery CR2032 * 1

USB Host can provide up to 5V/500mA of power, currently only supports FAT32 format.

Weight: approximately 800g

Dimensions (W*H*D) mm: 184*144*50

For more detailed descriptions on operations of the power quality control system, please contact Delta factory personnel.

4-2 Various Function Settings

4-2-1 System status bar

System status bar in the main screen is preset in the factory settings, it displays the system's model number, capacity, frequency, and usage. Users can see the system's current status from this display, which will update as the status changes.

4-2-2 Setting icons

4-2-2-1 Function settings

After touching the function setting key  , the display will show the screen below, for details on "Quick Start", "History", "Waveform", "Sys. Setting", " Advanced", and "Sys. Status" of this screen, please refer to 4-3 Detailed Descriptions of Function Settings



Tree diagram

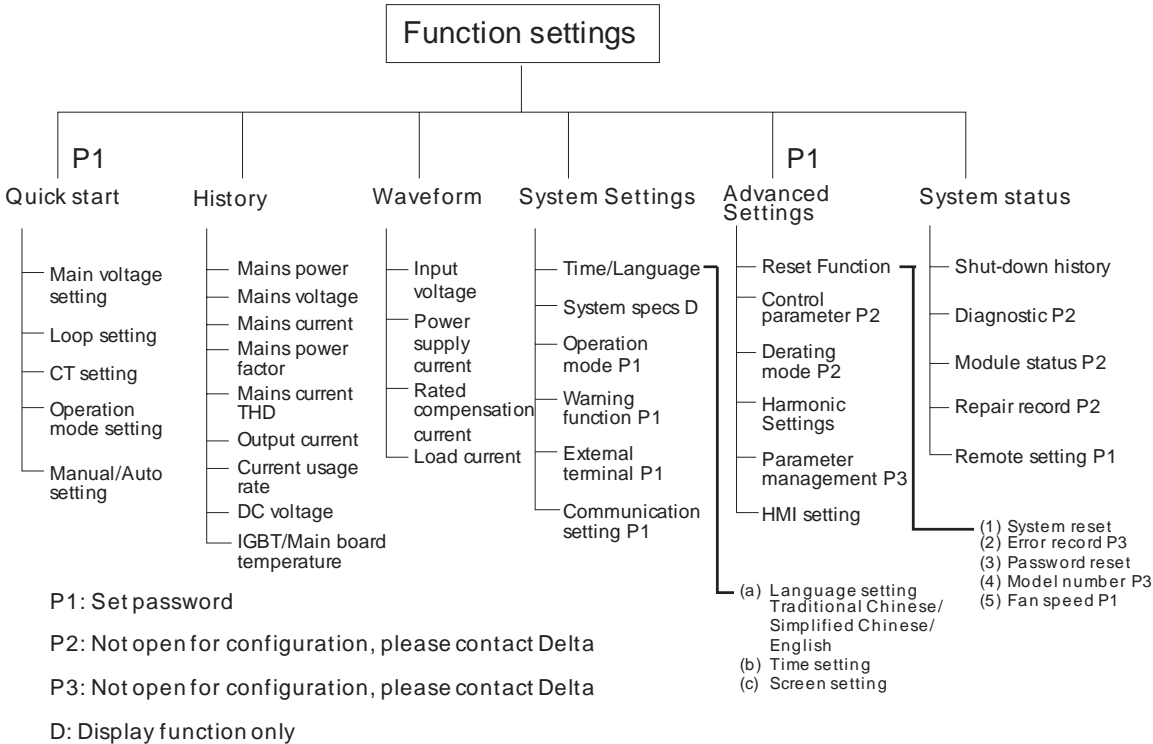



Figure 4-1 Tree diagram

4-2-2-2 Disabling warnings

The warning disabling key  , is only for "WARNING" signals. Touching the icon will disable this mode. If an "error" signal appears instead, touching this key will not disable it. For details on how it can be disabled, please refer to 05 Maintenance and Service.

4-2-2-3 Manual/Auto mode

Manual/Auto mode key: displays the current startup mode, for detailed settings please refer to 4-3-1 Installation Wizard

Scenario 1: Normally, the startup mode is set to "Auto". In case of emergency, touch the screen manually to force the system to a stop. At this point, the screen will display "Manual" mode, but it only means the current startup has been manually stopped. The actual startup mode is still set to "Auto" mode. Please be aware of these conditions.

Start mode: "Manual" 

The Static VAR Generator's startup mode is set to: "Manual". Users need to press  , to startup the Static VAR Generator.

If a warning/error dialogue box appears, users have to manually remove the dialogue box and press the "Disable warnings" button to complete the removal action. After completing the removal actions, users have to press  , to startup the Static VAR Generator again.

Start mode: "Auto" 

Auto start mode is selected. The Static VAR Generator will automatically restart in 30 seconds. If a warning/error dialogue box appears, the Static VAR Generator will automatically restart in 30 seconds and clear errors 10 seconds after the error occurs. The system will start operating automatically 30 seconds afterward. If users need to adjust the automatic restart time, please contact Delta factory personnel.

4-2-2-4 Return to the home screen

Return to the home screen key  , at any screen, touch this key, to immediately return to the home screen.

4-2-2-5 Startup (ON/OFF)

Startup key  , green light indicates: "ON", red light indicates: "OFF".

ON: running; OFF: shut off.

4-2-2-6 Display the menu in use

Displays the menu in use 『』, only acts as a display of the menu currently in use, users can clearly see which menu they are operating.

4-2-2-7 Screen Lock



Screen lock button "": this key prevents anyone from inadvertently touching the

function keys on the screen. For operation, press the "" button. The screen will show



the " " unlocked icon, and users will be able to operate using the function keys. After unlocking, the screen will lock automatically after 5 minutes of standby. Users can determine the status on the screen.

4-2-2-8 HELP

HELP key, 『』, touching this key gives access to the following 6 menus that can be touched to access: "Shut Down", "Model Settings", "CT Settings", "Boot Mode", "Operation Time", and "Time/Language".



"Shut Down"



"Model Settings"

Voltage(RMS)	0	V
Frequency(Hz)	0	Hz
CT Position		
CT Ratio	0	
CT Direction	Positive	
Operation Mode		
Auto/Manual	Manual	
System Capacity	0	

02/04/2013 15:35:00
Model Setting

"CT Settings"

CT Ratio → # : 5

CT Direction =  Positive

Total Power Capacity = 0 A

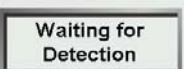
Direction Detection  

(Please refer to the CT spec. to set the primary side current)

02/04/2013 15:35:49
CT Direction Detection

"Operation Time"

Total Power-On Time
0 D 0 H 0 Min

Total Runing Time
0 D 0 H 0 Min

Continued Runing Time
0 D 0 H 0 Min

02/04/2013 15:36:28
Operation Time

"Boot Mode"



4-2-3 Function status area

The factory default screen is as shown in 4-1-2 Main screen display, displays detailed settings for the menu in use, and changes as the menu in use changes.

4-3 Detailed Descriptions of Function Settings

4-3-1 Quick start

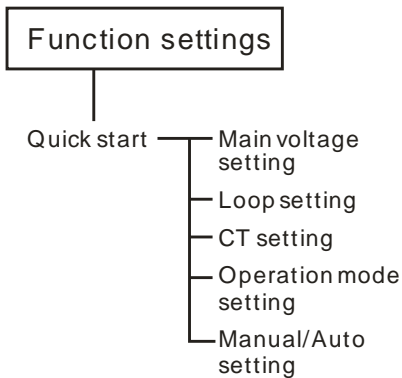

Before using quick start, the screen will prompt for password entry, the default password is: "20120123". Password has to be entered correctly, before various function settings can be accessed.

- 1) Main Voltage Settings: Please enter the main voltage and frequency, based on the actual input power, if unsure, check with your local dealer.



- 2) Loop Settings: Customers can choose to set an open loop or close loop. Currently, only the open loop option is available.

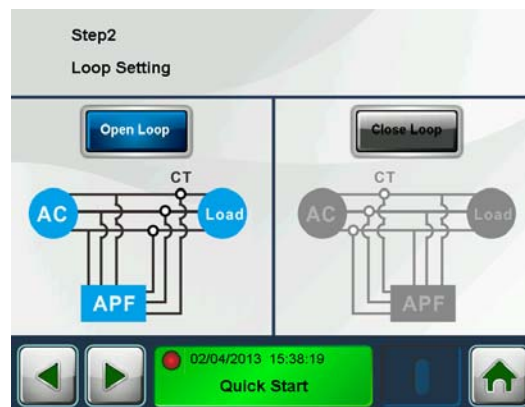

- 3) CT Settings:
CT Ratio: Please follow the specifications of the CT.
CT Direction: Positive (P1-P2), Negative (P2-P1).
When installing 3 CTs, their directions must be the same, if any one is installed incorrectly, please turn off the power before changing. Changing a CT with the power still on is not recommended as it will cause damage to the CT.
Total Power Capacity: Enter the total power capacity of the CTs connected in parallel; at most 6 can be connected in parallel.



4) Operation Mode:

Full Compensation: Compensate harmonics first. After compensating harmonics, compensate reactive power with any leftover power.

Harmonic Compensation: Only compensates harmonics, does not compensate reactive power.

Reactive Power Compensation: Only compensates reactive power, does not compensate harmonics.

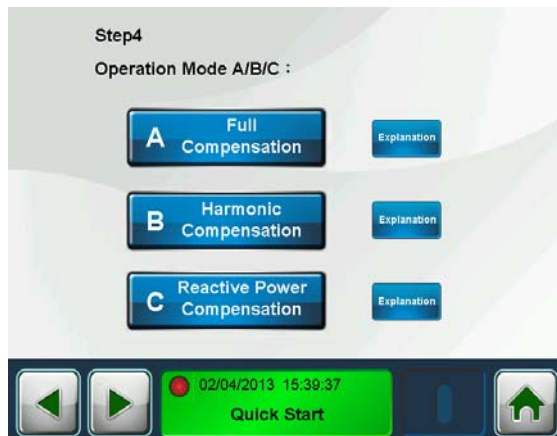

5) Boot Mode: The boot mode can be set to automatic or manual.



4-3-2 History

- 1) The lower tier selections are shown in the figure below, users can select each function's history based on their needs.
- 2) In addition to displaying each function's history, the recording period can also be configured from the

history screen (1, 5, 30, 60 days)

- 3) Exporting: Displays the total range sampled, users can select the storage method: "USB" or "SD Card".



4-3-3 Waveform

- 1) Waveform function: Provides 4 items to monitor, and has settings "Save Waveform", "Harmonics", "Single Refresh", and "Refresh".
- 2) Horizontal Scale: Values 1~5; Vertical Scale: Values 0.1~4;

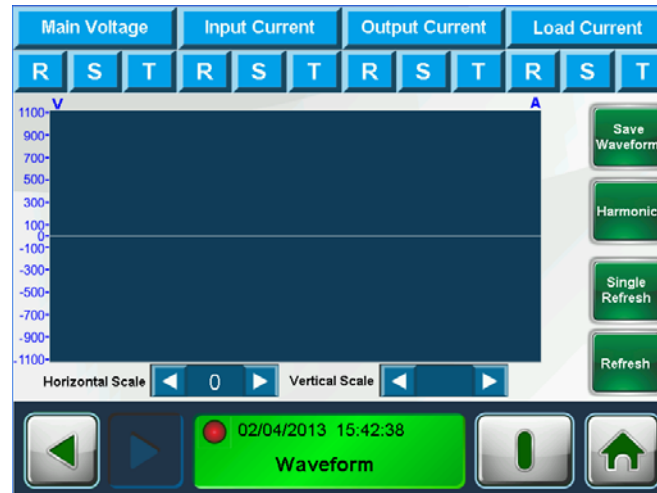

4-3-4 System Settings



To enter various function settings under system settings, the screen will prompt for password entry, the default password is: "20120123". The various functions can only be displayed or set after successful password entry (as shown in the figure below).

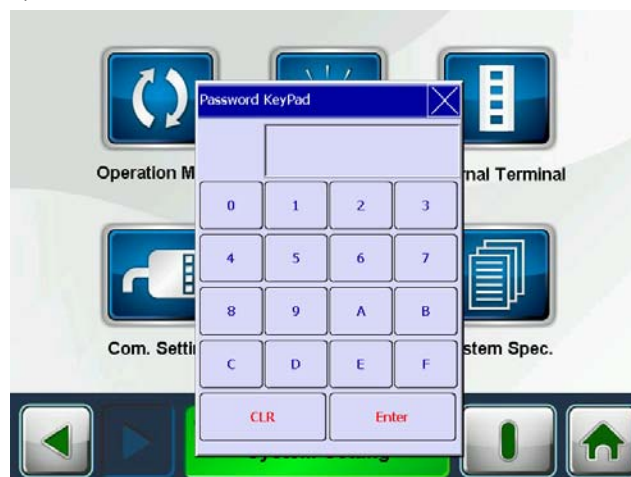

Note 1: The default password is: "20120123". This password can only access settings for basic functions. After entering the password, all functions can be accessed freely. If the system is inactive for more than 10

minutes, the password must be entered again before the functions can be used.

Note 2: As functions are divided into different levels and are controlled by different passwords, the default password is "read only" for advanced settings. To access more functions, please contact Delta.

1) Operation Mode:

Full Compensation: Compensate harmonics first. After compensating harmonics, compensate reactive power with any leftover power.

Harmonic Compensation: Only compensates harmonics, does not compensate reactive power.

Reactive Power Compensation: Only compensates reactive power, does not compensate harmonics.

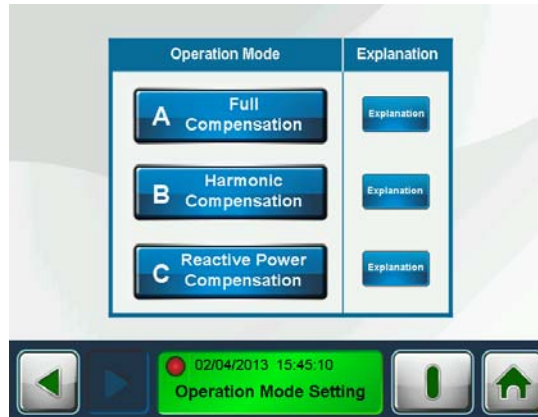

2) Warning Settings

Enter the default password, "20120123", to access warning related parameters as shown in the figure below.

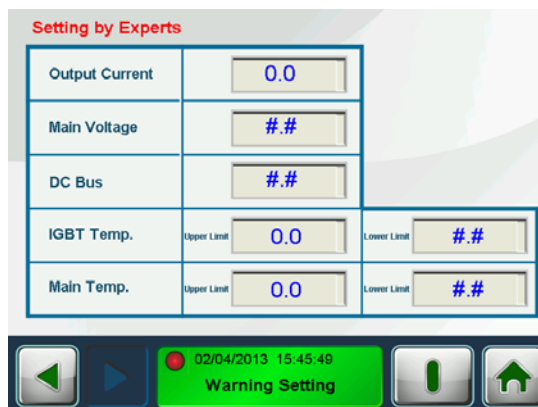

3) External Terminal Settings

Enter the default password, "20120123", to access various external terminal settings.

"Positive": the terminal contact operation is ON.

"Negative": the terminal contact operation is OFF.

MI1	Setting	RUN/STOP
MI2	contents	EF1 RESET
RA1	Setting	Running
RA2	contents	Ready(PLL OK)
MO1		Error Indication
MO2		Warning Indication Standby



4) Communication Settings

Enter the default password, "20120123", to access various communication settings.



5) Time/Language



This function setting can display various firmware versions, and adjust 3 other settings as well.

Time/Date: As shown in the figure below, use the function keys +/-</> to make adjustments. Press "Save" afterward to save. To leave this screen, simply press "Quit". Pressing the X on the top right corner will also close this dialogue box.

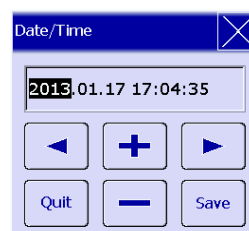

Screen Saver: The default setting is 10 minutes. Users can configure the settings. Value range: 10~120 minutes.

Language: Currently available: Traditional Chinese, Simplified Chinese, English. Pressing the Language settings changes the system language.

6) System Specifications

Provides the specifications sheets for the model in use, to get specifications for other models, refer to 03 Specifications

50A Spec		Technical Spec	
Basic Spec		Technical Spec	
Model	APF50A43X-31	Step Response Time	<300µs
Rated Compensation Current	50A	Total Response Time	<20ms
Rated Voltage	220V~480Vac	Carrier Frequency	15KHz
Voltage Tolerance	-10%~+10%	Harmonic Compensation	2nd to 50th harmonic
Grid Frequency	50Hz±60Hz±5%	Harmonic Compensation Performance	≥95%
Cooling Method	Fan Cooling	Parallel Configuration	2~6 units
Current Transformers Ratio (CT Ratio)	50 : 5 to 10,000 : 5	Human Machine Interface	65535 Colors 7" Touchscreen
Power Loss	<1300W	Data Storage	USB Drive, SD Card
Noise Level (ISO 7779)	63dBA	Communication Port	RJ45(Ethernet) D-Sub(RS-232) RJ45(RS-485)
Cable Entry	Bottom	Communication Protocol	MODBUS MODBUS TCP *Optional: DeviceNet PROFIBUS CANopen
Installation Method	Wall-mounted		
Operation temperature	-10°C ~ +45°C		
Dimensions (mm)	A *1 370x590x311		
Width x Height x Depth	B *1 370x590x345		
Weight (Kg)	48kg ±10%		
Enclosure Rating	IP31(NEMA1)		
Approvals	CE UL cUL C-Tick		

[*1] A=APFXXXXA43A ; B=APFXXXXA43B
[*2] 2013 Q1

4-3-5 Advanced Settings

To access these settings, please contact Delta personnel. Entering the default password, "20120123", allows the advanced settings to be "read only", as shown in the figure below. Only some of the settings can be configured.

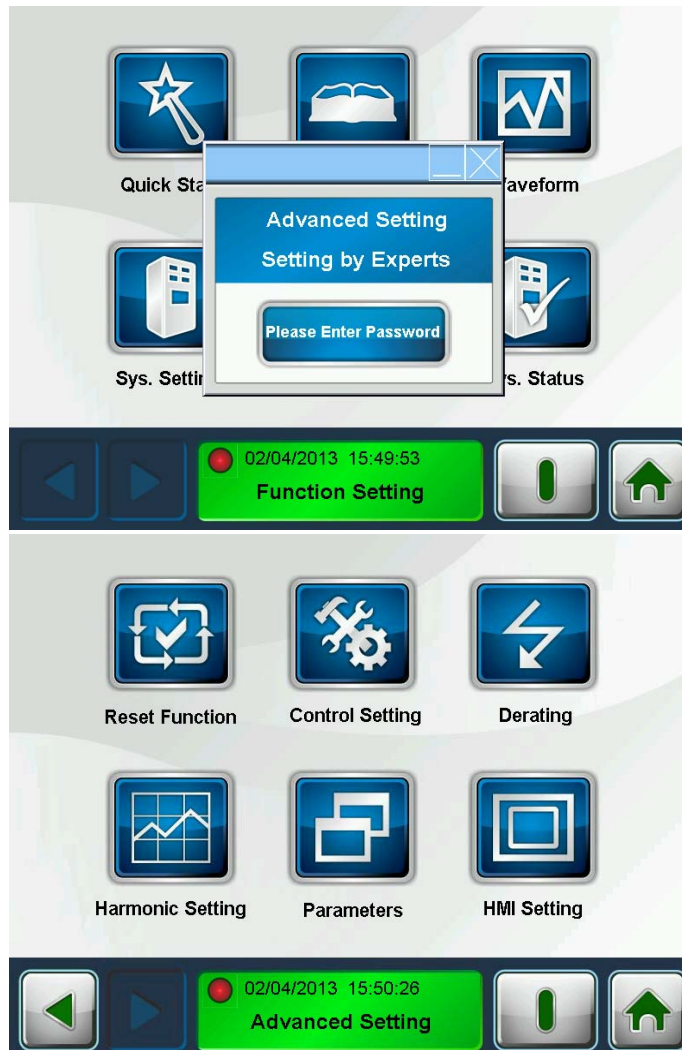

1) Reset Function

In this function, only "System Reset" and "Password" can be configured. To configure other settings, please contact Delta.

The default password is: "20120123", which can be changed in "Password". After changing the password, please remember and manage the password safely. If forgotten, please contact Delta for assistance.



2) Control Parameters

Enter the default password, "20120123", allows "read only" access to these settings, as shown in the figure below. To configure these settings, please contact Delta.

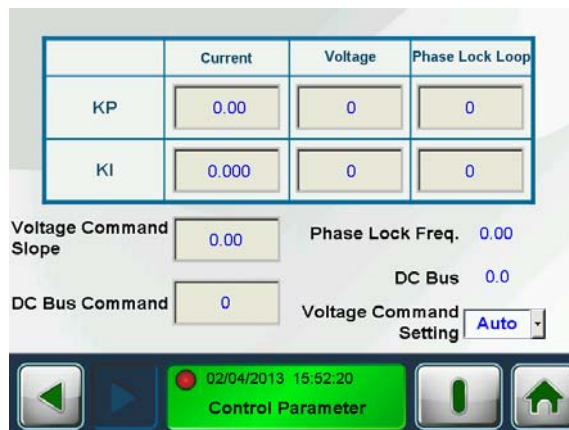

3) Derating Mode

Enter the default password, "20120123", allows "read only" access to these settings, as shown in the figure below. To configure these settings, please contact Delta.



4) Harmonic Settings

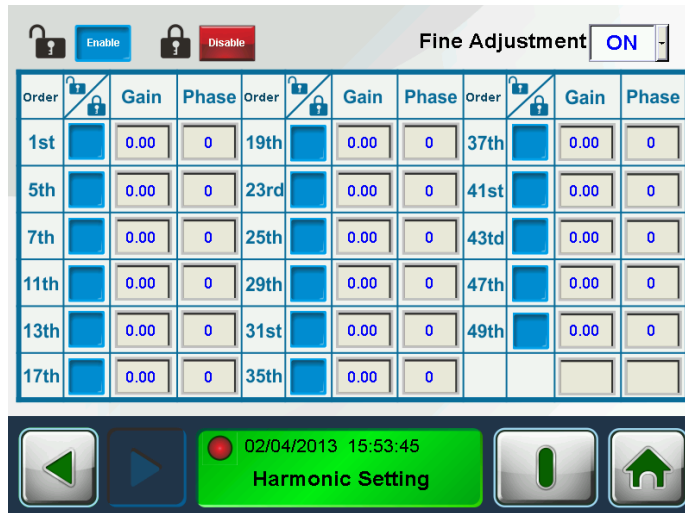

5) HMI Settings

To leave this screen, touch the top right corner to return to the previous screen.

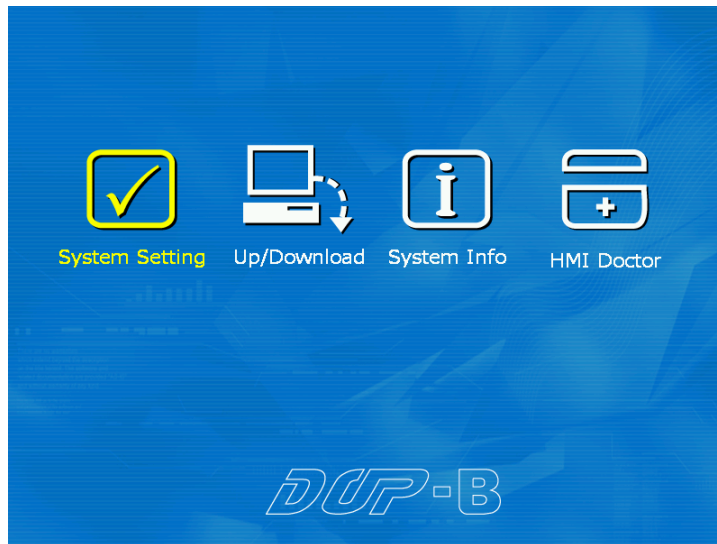

4-3-6 System status

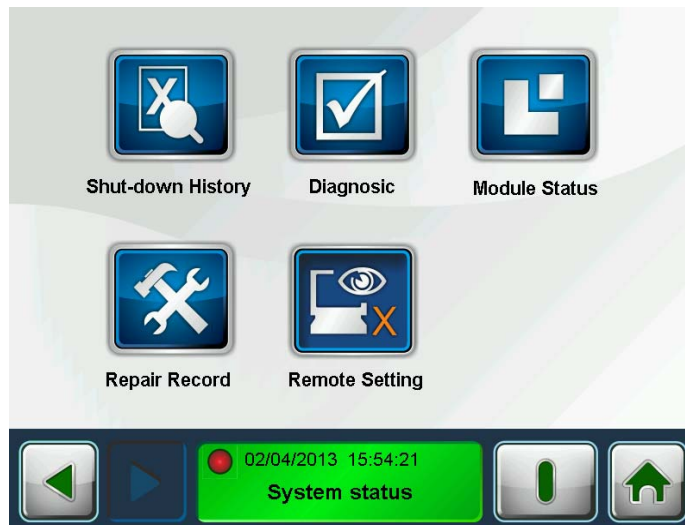

- 1) Shut-down History: This function records failures during operation; warnings are not included. Records 200 sets of occurrence time (hh:mm:ss), date (mm:dd:yyyy) and details of the failure.

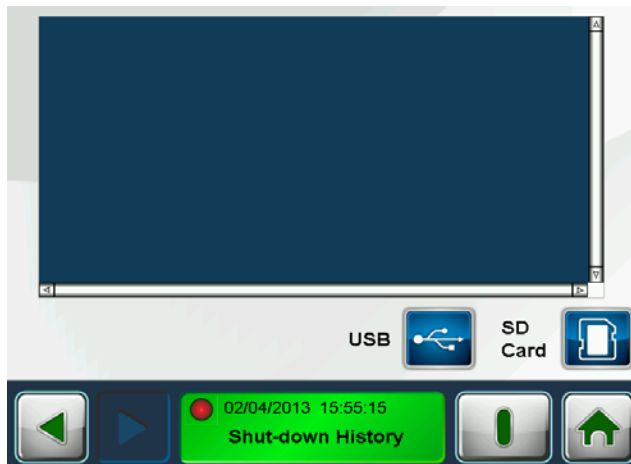

- 2) Diagnostics

Enter the default password, "20120123", allows "read only" access to these settings, as shown in the figure below. To configure these settings, please contact Delta.

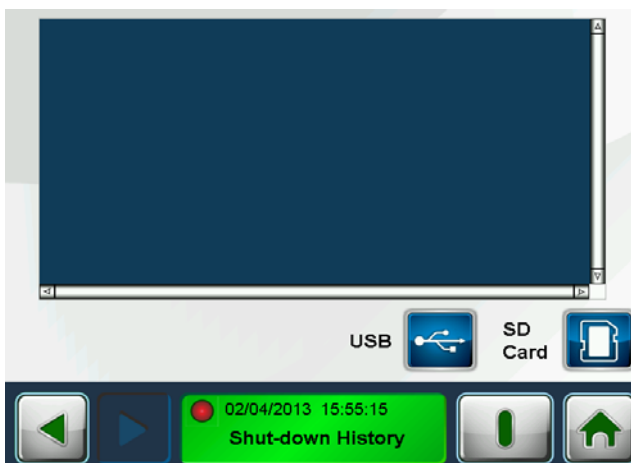

- 3) Module Status:

Enter the default password, "20120123", allows "read only" access to these settings, as shown in the figure below. To configure these settings, please contact Delta.

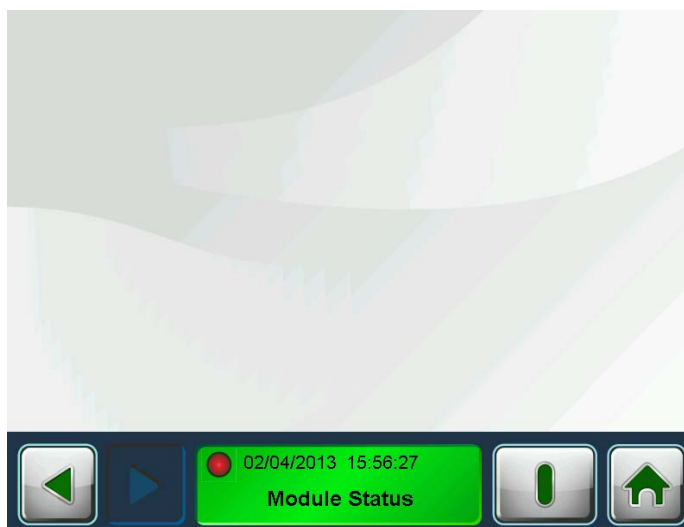

- 4) Repair Records: Records 5 sets of repair records.

Enter the default password, "20120123", allows "read only" access to these settings, as shown in the

figure below. To configure these settings, please contact Delta.

Item	Date	Repair List	Add/Del
1	0 Y 0 M 0 D		+ CLR
2	0 Y 0 M 0 D		+ CLR
3	0 Y 0 M 0 D		+ CLR
4	0 Y 0 M 0 D		+ CLR
5	0 Y 0 M 0 D		+ CLR



5) Remote Settings

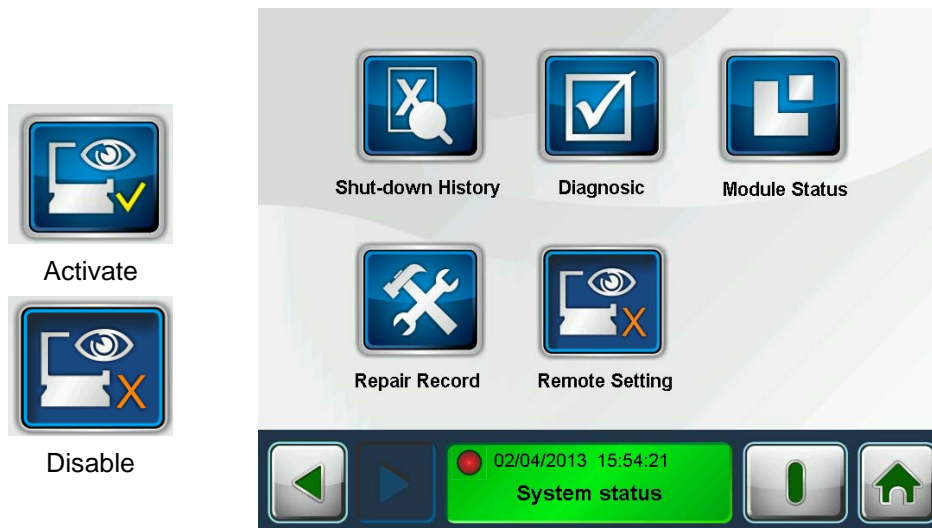

To use remote monitoring, please contact Delta factory personnel for assistance with the settings.

5 Maintenance and Service

5-1 Troubleshooting

The following table shows errors that may appear on the Active Power Filter (APF). Through the display of the power quality management system, a beeping sound can be set as an external warning. Before the "warning/error dialogue boxes" listed in the following table are cleared, they will remain on the screen. The error messages will be recorded in the power quality management system, users can look them up in the "Shut-down History" (refer to 4-3-5 System Data for more details). After the warning screen is cleared, it will not be recorded in the "Shut-down History".

Boot mode: Manual

If a warning/error dialogue box appears, users have to manually remove the dialogue box and press the "Disable warnings" button to complete the removal action.



Boot mode: Auto





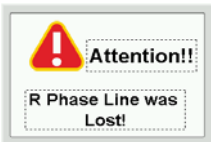
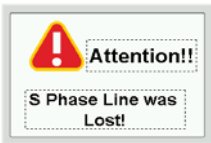
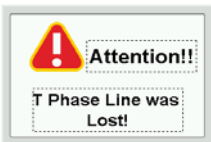

The Active Power Filter automatically restarts 6 seconds after the user presses the disable warnings button. If the warning appears in 3 consecutive restarts (default value), the system will not restart, and users will have to restart manually.



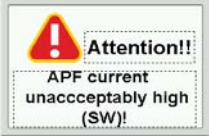

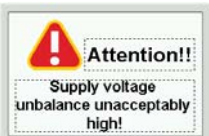
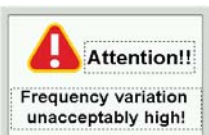
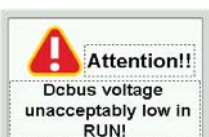
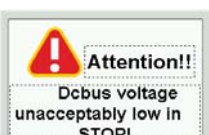

The power quality management system can record 200 sets of error messages, and record the time and date of occurrence.

In the following irregular situations, if there is a need to open the Active Power Filter, please note:

- (1) In such cases, please turn off the Active Power Filter's power first.
- (2) Before checking fuses to see if they are intact, please make sure the Active Power Filter's power is off, and has been off for more than 10 minutes. Before making contact, please check with a voltmeter that the bus capacitors are discharged.

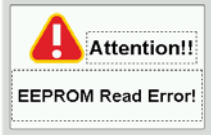
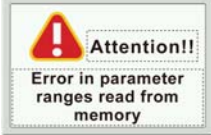
Panel display	Description	Solution
	R-phase voltage detection error	Check whether the power supply voltage is normal Turn off the power and check whether the input contacts are loose, tighten up if necessary Restart the system. If the problem persists, send for repair
	S-phase voltage detection error	Check whether the power supply voltage is normal Turn off the power and check whether the input contacts are tightened. Tighten again if necessary Restart the system. If the problem persists, send for repair
	T-phase voltage detection error	Check whether the power supply voltage is normal Turn off the power and check whether the input contacts are tightened. Tighten again if necessary Restart the system. If the problem persists, send for repair
	Instantaneous large current sent through IGBT module	Check whether the power supply voltage is normal Restart the system. If the problem persists, send for repair

Panel display	Description	Solution
	Output current exceeded safe operating range during operation	Check whether the power supply voltage is normal Check whether the system model number matches with the machine Check whether the phase-locked frequency matches the power supply frequency Check whether the CT wiring is correct and in the correct phase sequence Check whether the system temperature is within operating range
	The level of input voltage exceeds the preset level	Check whether the input voltage is within the rated voltage range, and monitor for voltage surges.
	While in operation, overvoltage on the high-voltage end of the internal DC voltage is detected.	Check whether the input voltage is within the rated voltage range, and monitor for voltage surges.
	Overvoltage while turned off. Voltage detection hardware circuit error	Check whether the input voltage is within the rated voltage range, and monitor for voltage surges.
	The level of input voltage unbalance exceeds the preset level	Check whether the power supply voltage is normal Turn off the power and check whether the input contacts are tightened. Tighten again if necessary Restart the system. If the problem persists, send for repair
	The level of phase-locked frequency beats of the input voltage exceeds the preset level	Check whether the power supply voltage is normal Turn off the power and check whether the input contacts are tightened. Tighten again if necessary Restart the system. If the problem persists, send for repair
	While in operation, a voltage lower than the rated voltage on the internal high DC end is detected.	Check whether the power supply input voltage is normal Check whether there has been a sudden overload
	While turned off, a voltage lower than the rated voltage on the internal high DC end is detected.	Check whether the power supply input voltage is normal Check whether there has been a sudden overload
	IGBT temperature exceeds the protection level	Check whether the ambient temperature is too high Check for foreign objects in the heat sink and whether the fan is spinning Check whether there is enough room for ventilation

Panel display	Description	Solution
	Main board temperature exceeds the protection level	<p>Check whether the ambient temperature is too high</p> <p>Check for foreign objects in the heat sink and whether the fan is spinning</p> <p>Check whether there is enough room for ventilation</p>
	Main board temperature detection circuit error	Send for repair
	Memory circuit error	<p>Press the RESET key to restore the parameters to factory settings</p> <p>If this does not work, send for repair</p>
	Errors in the parameter ranges read from memory	<p>Press the RESET key to restore the parameters to factory settings</p> <p>If this does not work, send for repair</p>
	Voltage boost failure during operation	Check whether the power supply voltage is normal
	Output current exceeded safe operating range during operation	<p>Check whether the power supply voltage is normal</p> <p>Check whether the system model number matches with the machine</p> <p>Check whether the phase-locked frequency correctly matches the power supply frequency</p> <p>Check whether the CT wiring is correct and in the correct phase sequence</p> <p>Check whether the system temperature is within operating range</p>
	Electromagnetic contactor acting irregularly	<p>Check whether the power supply voltage is normal</p> <p>Cut off the power, check whether the wirings between transformer and power supply comply with the power supply voltage level</p> <p>Check whether the mains voltage is the same as the power supply voltage in the HMI main screen</p>
	Cannot complete power supply phase-locking	<p>Check whether the power supply voltage is normal</p> <p>Check whether the main wiring frequency setting is the same as the power supply frequency</p>