



Industrial Automation Headquarters

Delta Electronics, Inc.
Taoyuan Technology Center
18 Xinglong Road, Taoyuan District,
Taoyuan City 33068, Taiwan
TEL: 886-3-362-6301 / FAX: 886-3-371-6301

Asia

Delta Electronics (Shanghai) Co., Ltd
No.182 Minyu Road, Pudong Shanghai,
People's Republic of China
Post code : 201209
TEL: 86-21-68723988 / FAX: 86-21-6872-3996
Customer Service: 400-820-9595

Delta Electronics (Japan), Inc.
Tokyo Office
2-1-14 Minato-ku Shibadaimon,
Tokyo 105-0012, Japan
TEL: 81-3-5733-1111 / FAX: 81-3-5733-1211

Delta Electronics (Korea), Inc.
1511, Byucksan Digital Valley 6-cha, Gasan-dong,
Geumcheon-gu, Seoul, Korea, 153-704
TEL: 82-2-515-5303 / FAX: 82-2-515-5302

Delta Electronics Int'l (S) Pte Ltd.
4 Kaki Bukit Ave 1, #05-04, Singapore 417939
TEL: 65-6747-5155 / FAX: 65-6744-9228

Delta Electronics (India) Pvt. Ltd.
Plot No 43 Sector 35, HSIIDC
Gurgaon, PIN 122001, Haryana, India
TEL: 91-124-4874900 / FAX : 91-124-4874945

Delta Electronics (Thailand) Public Company Limited
909 Soi 9, Moo 4, Bangpoo Industrial
Estate(Epz) Pattana 1rd., Tambol Phraksa
Amphur Muang, Samutprakarn 10280 Thailand
TEL: 66(0)2-709-2800

Delta Energy Systems Australia Pty Ltd.
Unit 20-21, 45 Normanby rd, Notting Hill Vic 3168, Australia
TEL: 61-3-9543-3720

Americas

Delta Products Corporation (USA)
Raleigh Office
P.O. Box 12173, 5101 Davis Drive,
Research Triangle Park, NC 27709, U.S.A.
TEL: 1-919-767-3800 / FAX: 1-919-767-3969

Delta Greentech (Brasil) S.A.
Sao Paulo Office
Rua Itapeva, 26 - 3° andar Edificio Itapeva One-Bela Vista
01332-000-São Paulo-SP-Brazil
TEL: 55-11-3530-8642 / FAX: 55-11-3530-8640

Delta Electronics Int. Mexico
Mexico Office
Via Dr. Gustavo Baz 2160, La Loma
C.P. 54060, Estado de México
TEL: 52-55-2628-3015

DELTA_IA-MDS_VFD-ED_UM_EN_20171229

*We reserve the right to change the information in this user manual without prior notice.

EMEA

Delta Electronics (Netherlands) B.V.
Eindhoven Office
De Witbogt 20, 5652 AG Eindhoven, The Netherlands
TEL: 31 (0) 40-8003800 / FAX: 31 (0) 40-8003898
MAIL: Sales.IA.EMEA@deltaww.com
MAIL: Sales.IA.Benelux@deltaww.com

Delta Energy Systems (France) S.A
ZI du bois Chaland 2 15 rue des Pyrénées,
Lisses 91056 Evry Cedex
MAIL: Sales.IA.France@deltaww.com

Delta Energy Systems (Spain) S.L.
Ctra. De Villaverde a Vallecas, 265 1° Dcha Ed.
Hormigueras – P.I. de Vallecas 28031 Madrid
C/Llul, 321-329 (Edif. CINC) | 22@Barcelona | 08019 Barcelona
MAIL: Sales.IA.Iberia@deltaww.com

Delta Energy Systems Srl (Italy)
Via Senigallia 18/2 – 20161 Milano (MI)
Piazza Grazioli 18 – 00186 ROMA
MAIL: Sales.IA.Italy@deltaww.com

Delta Energy Systems (Germany) GmbH
Coesterweg 45, D-59494 Soest
MAIL: Sales.IA.DACH@deltaww.com

Delta Energy Systems LLC (CIS)
Vereyskaya Plaza II, office 112 Vereyskaya str.
17 121357 Moscow
MAIL: Sales.IA.RU@deltaww.com

Delta Greentech Ltd. (Turkiye)
Şerifali Mevkii Barbaros Bulvarı Söyleşi Sokak
No:19 K:1 Yukari Dudullu 34775 Ümraniye
İstanbul Sarıgazi V.D 2740624765
MAIL: Sales.IA.Turkey@delta-emea.com

Delta Energy Systems (AG Dubai BR)
P.O. Box 185668, Gate 7, 3rd Floor, Hamarain Centre,
Dubai, United Arab Emirates
MAIL: Sales.IA.MEA@deltaww.com

Delta Elevator Drive VFD-ED Series User Manual



Delta Elevator Drive VFD-ED Series User Manual



www.deltaww.com



Thank you for choosing DELTA's high-performance VFD-ED Series. The VFD-ED Series is manufactured with high-quality components and materials and incorporates the latest microprocessor technology available.

This manual is to be used for the installation, parameter setting, troubleshooting, and daily maintenance of the AC motor drive. To guarantee safe operation of the equipment, read the following safety guidelines before connecting power to the AC motor drive. Keep this operating manual at hand and distribute to all users for reference.

To ensure the safety of operators and equipment, only qualified personnel familiar with AC motor drive are to do installation, start-up and maintenance. Always read this manual thoroughly before using VFD-ED series AC Motor Drive, especially the WARNING, DANGER and CAUTION notes. Failure to comply may result in personal injury and equipment damage. If you have any question, please contact your dealer.

PLEASE READ PRIOR TO INSTALLATION FOR SAFETY.



1. AC input power must be disconnected before any wiring to the AC motor drive is made.
2. A charge may still remain in the DC-link capacitors with hazardous voltages, even if the power has been turned off. To prevent personal injury, please ensure that power has turned off before opening the AC motor drive and wait ten minutes for the capacitors to discharge to safe voltage levels.
3. Never reassemble internal components or wiring.
4. The AC motor drive may be destroyed beyond repair if incorrect cables are connected to the input/output terminals. Never connect the AC motor drive output terminals U/T1, V/T2, and W/T3 directly to the AC mains circuit power supply.
5. Ground the VFD-ED using the ground terminal. The grounding method must comply with the laws of the country where the AC motor drive is to be installed. Refer to the Basic Wiring Diagram.
6. VFD-ED series is used only to control variable speed of 3-phase induction motors, NOT for 1-phase motors or other purpose.
7. VFD-ED series shall NOT be used for life support equipment or any life safety situation.



1. DO NOT use Hi-pot test for internal components. The semi-conductor used in AC motor drive easily damage by high-voltage.
2. There are highly sensitive MOS components on the printed circuit boards. These components are especially sensitive to static electricity. To prevent damage to these components, do not touch these components or the circuit boards with metal objects or your bare hands.
3. Only qualified persons are allowed to install, wire and maintain AC motor drives.



1. Some parameters settings can cause the motor to run immediately after applying power.
2. DO NOT install the AC motor drive in a place subjected to high temperature, direct sunlight, high humidity, excessive vibration, corrosive gases or liquids, or airborne dust or metallic particles.
3. Only use AC motor drives within specification. Failure to comply may result in fire, explosion or electric shock.
4. To prevent personal injury, please keep children and unqualified people away from the equipment.
5. When the motor cable between AC motor drive and motor is too long, the layer insulation of the motor may be damaged. Please use a frequency inverter duty motor or add an AC output reactor to prevent damage to the motor. Refer to appendix B Reactor for details.
6. The rated voltage for AC motor drive must be $\leq 240V$ ($\leq 480V$ for 460V models) and the mains supply current capacity must be $\leq 5000A$ RMS ($\leq 10000A$ RMS for the $\geq 40hp$ (30kW) models)

Firmware version: 1.04

Table of Contents

PUBLICATION HISTORY	PubHi-1
CHAPTER 1 INTRODUCTION	1-1
1-1 Receiving and Inspection.....	1-1
1-2 Nameplate Information.....	1-1
1-3 Model Name.....	1-1
1-4 Serial Number.....	1-1
1-5 Apply for After-sales Service by Mobile Device.....	1-2
1-6 RFI Switch.....	1-5
1-7 Dimensions.....	1-9
CHAPTER 2 INSTALLATION	2-1
2-1 About Installation.....	2-1
2-2 Minimum Mounting Clearance.....	2-2
CHAPTER 3 WIRING	3-1
3-1 Wiring.....	3-2
3-2 System Wiring Diagram.....	3-7
CHAPTER 4 MAIN CIRCUIT TERMINALS	4-1
4-1 Main Circuit Diagram.....	4-2
4-2 Main Circuit Terminals Specifications.....	4-4
CHAPTER 5 CONTROL TERMINALS	5-1
5-1 Remove the Cover before Wiring.....	5-1
5-2 Specification of the Control Terminals.....	5-3
5-3 Control Circuit Terminal Sockets.....	5-3
CHAPTER 6 OPTIONAL ACCESSORIES	6-1
6-1 Brake Resistors and Brake Units Used in AC Motor Drives.....	6-1
6-2 Non-fuse Circuit Breaker.....	6-4
6-3 Fuse Specification Chart	6-4
6-4 AC/DC Reactor.....	6-5
6-5 Zero Phase Reactor.....	6-7
6-6 EMI Filter.....	6-9
6-7 Digital Keypad.....	6-20
6-8 USB/RS-485 Communication Interface IFD6530.....	6-23
CHAPTER 7 OPTION CARDS	7-1
Remove the top cover.....	7-1
Screws' Specification for Option Card Terminals.....	7-2

7-1 EMED-PGABD-1.....	7-3
7-2 EMED-PGHSD-1.....	7-7
7-3 EMED-PGHSD-2.....	7-10
CHAPTER 8 SPECIFICATION.....	8-1
8-1 230V Series.....	8-1
8-2 460V Series.....	8-1
General Specifications.....	8-2
CHAPTER 9 DIGITAL KEYPAD	9-1
9-1 Descriptions of Digital Keypad	9-1
9-2 Operating the Built-in Digital Keypad	9-3
9-3 Description of Digital Keypad KPC-CC01	9-4
9-4 Function of Digital Keypad KPC-CC01	9-6
9-5 Digital Keypad KPC-CC01 Fault Code Description	9-18
9-6 TPEditor Installation	9-22
CHAPTER 10 AUTO-TUNING PROCESSS	10-1
CHAPTER 11 SUMMARPY OF PARAMETERS.....	11-1
CHAPTER 12 DESCRIPTION OF PARAMETER SETTINGS	12-1
CHAPTER 13 WARNING CODES	13-1
CHAPTER 14 FAULT CODES	14-1
CHAPTER 15 SUGGESTION & ERROR CORRECTIONS FOR STANDARD AC MOTOR DRIVES.....	15-1
CHAPTER 16 FUNCTION OF SAFETY TORQUE OFF	16-1
APPENDIX A. AC MOTOR DRIVES EMC STANDARD INSTALLATION GUIDE.....	I

Please include the Issue Edition and the Firmware Version, both shown below, when communicating with Technical Support regarding this publication.

Firmware Version: 1.04

Issue date: December 2017

Publication History

PAGE	UPDATES
1-2 ~ 1-4	Add section 1-5 Apply for After-sales service.

PAGE	MODIFICATIONS
1-6	Isolating main power from ground: The RFI short-circuit cable has to be cut off while conducting high voltage tests.
11-09	Pr03-17 #10, change ACI to Reserved.
11-10	Pr03-20 #9, change AVI to AUI1.
11-10	Pr03-20 #10, change ACI to Reserved.
11-10	Pr03-20 #11, change AUI to AUI2
11-12	Pr05-13, remove VF and VFPG functions.
11-16	Pr06-45, change the factory setting from 0 to 0002h.
11-24	Pr11-00, change the factory setting from 0 to 000h.
12-37	Pr05-13, remove VF and VFPG functions.

01 Introduction

1-1 Receiving and Inspection

After receiving the AC motor drive, please check for the following:

- 1) Inspect the unit after unpacking to assure it was not damaged during shipment. Make sure that the part number printed on the package corresponds with the part number indicated on the nameplate.
- 2) Make sure that the voltage for the wiring lie within the range as indicated on the nameplate. Install the AC motor drive according to this manual.
- 3) Before applying the power, make sure that all the devices, including power, motor, control board and digital keypad, are connected correctly.
- 4) When wiring the AC motor drive, make sure that the wiring of input terminals "R/L1, S/L2, T/L3" and output terminals "U/T1, V/T2, W/T3" are correct to prevent drive damage.
- 5) When power is applied, select the language and set parameter groups via the digital keypad (KPED-LE01). When executing a trial run, begin with a low speed and then gradually increase the speed until the desired speed is reached.

1-2 Nameplate Information

Using 15HP/11kW 230V, 3-Phase as an example.

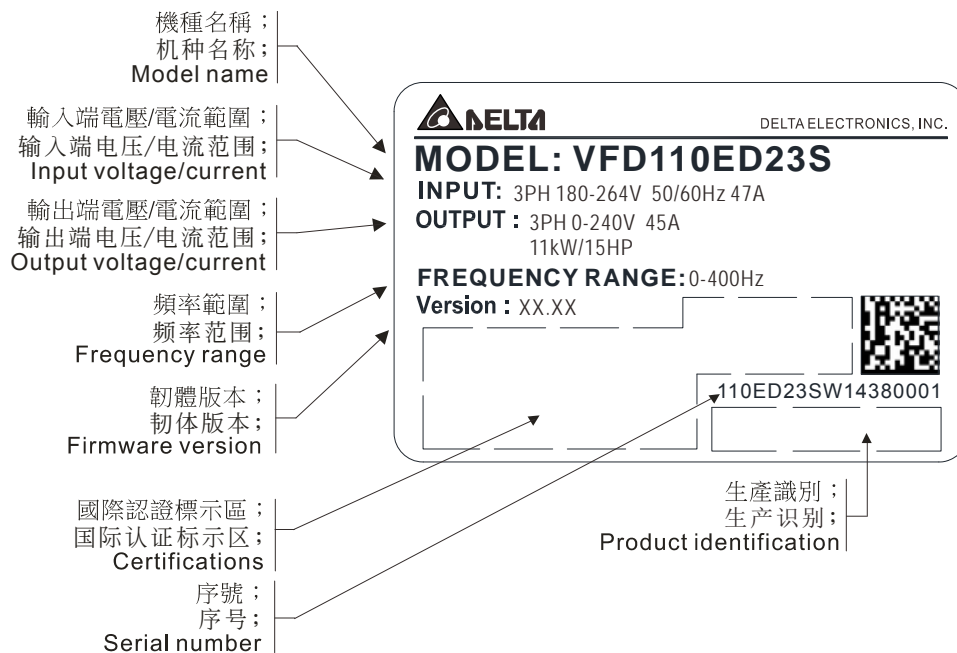

1-3 Model Name

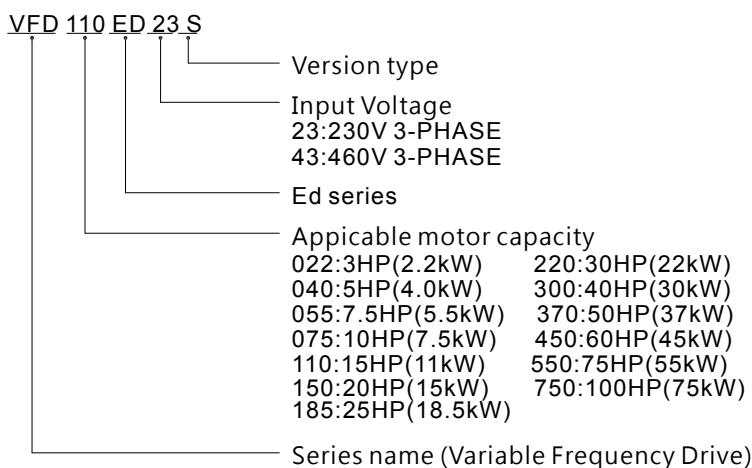

1-4 Serial Number

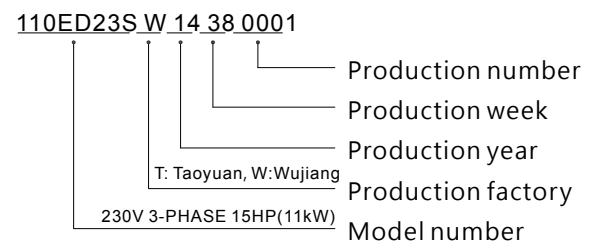

1-5 Apply for After-sales Service by Mobile Device

1-5-1 Location of Service Link Label

Frame B

The service link label (service label) is located on the side of the case as shown in the image blow:

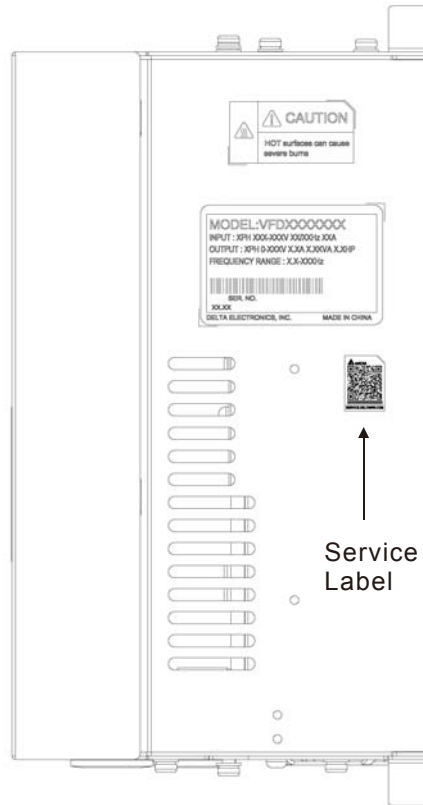

Frame C

Remove the front cover of the case and you will find the service link label (service label) which is located on the upper left corner as shown in the image below:

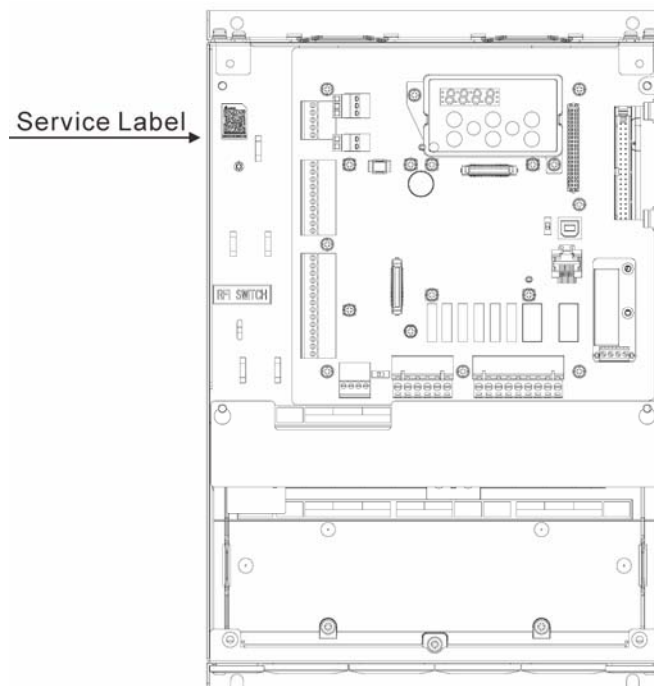

Frame D

Remove the front cover of the case and you will find the service link label (service label) which is located on the upper left corner as shown in the image below:

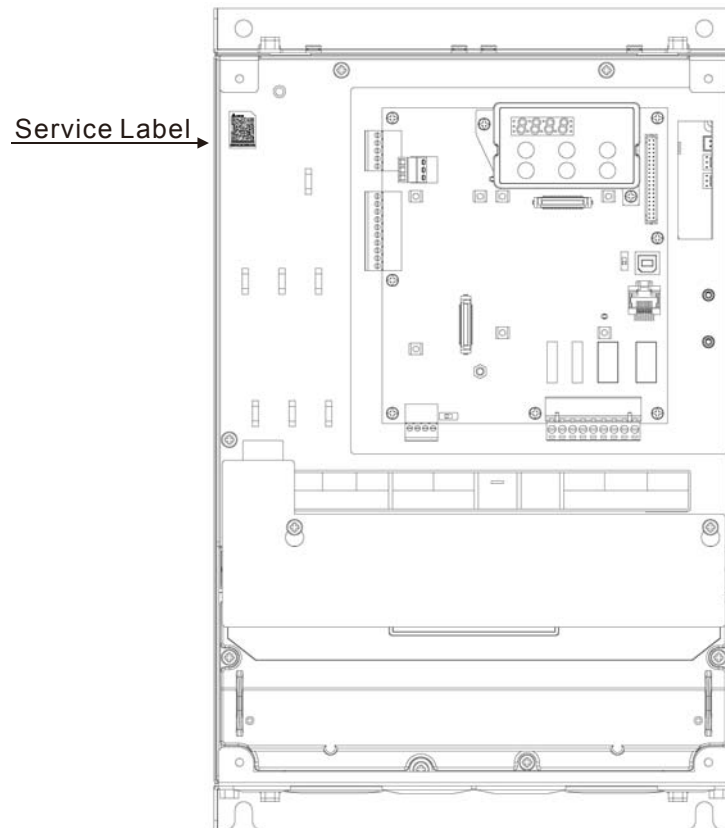
**Frame E**

Remove the front cover of the case and you will find the service link label (service label) which is located on the upper left corner as shown in the image below:

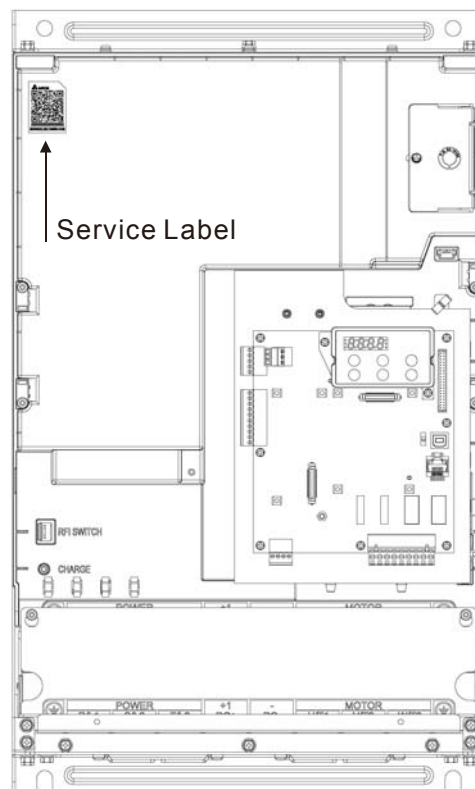

1-5-2 Service Link Label



- ← QR code
<http://service.deltaww.com/ia/repair?sn=serial number>
- ← Serial number
- ← Web address of after-sales service

Scan QR Code to apply

1. Find the QR code sticker (as shown above).
2. Run the QR code reader app on your smartphone.
3. Point your camera to the QR Code. Hold your camera steady so that the QR code comes into focus.
4. Access the Delta After-Sales Service website.
5. Fill in the information into the column marked with an orange star.
6. Enter the CAPTCHA and click “Submit” to complete the application.

Cannot find QR Code?

1. Open a web browser on your computer or smart phone.
2. Key in <https://service.deltaww.com/ia/repair> in address bar and press enter.
3. Fill in the information into the columns marked with an orange star.
4. Enter the CAPTCHA and click “Submit” to complete the application.

1-6 RFI Switch

The AC motor drive may emit the electrical noise. The RFI switch is used to suppress the interference (Radio Frequency Interference) on the power line. The RFI Switch of Frame C, D, E are at similar position (Frame B doesn't have a RFI Switch). Open the top cover to remove the RFI switch as shown in the image below.

Frame E

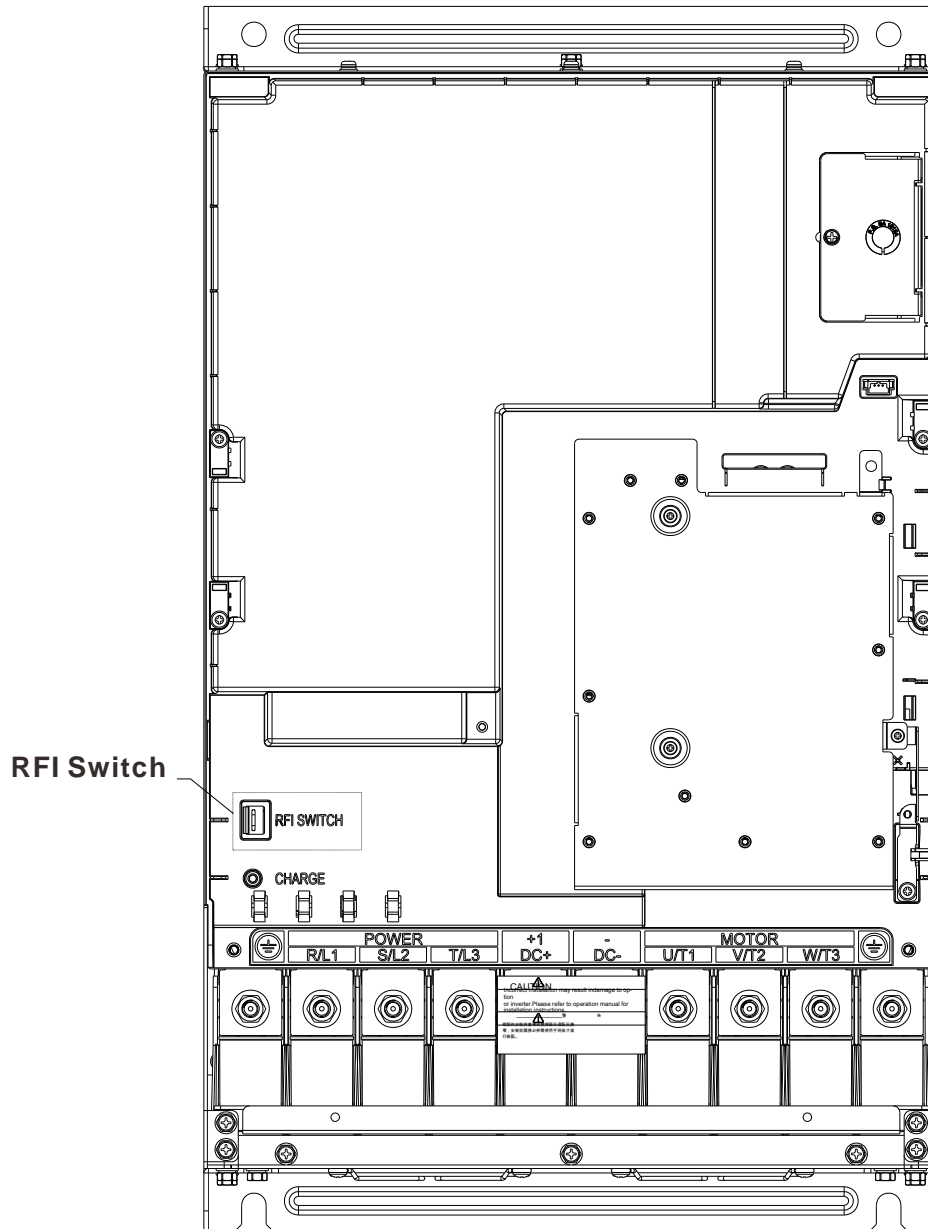

Isolating main power from ground:

When the power distribution system of the motor drive is a floating ground system (IT) or an asymmetric ground system (TN), the RFI short-circuit cable must be cut off. Cutting off the short-circuit cable also cuts off the internal RFI capacitor (filter capacitor) between the system's frame and the central circuits to avoid damaging the central circuits and (according to IEC 61800-3) reduce the ground leakage current.

Important points regarding ground connection

- ☑ To ensure the safety of personnel, proper operation, and to reduce electromagnetic radiation, the motor drive must be properly grounded during installation.
- ☑ The diameter of the cables must meet the size specified by safety regulations.
- ☑ The shielded cable must be connected to the ground of the motor drive to meet safety regulations.
- ☑ The shielded cable can only be used as the ground for equipment when the aforementioned points are met.
- ☑ When installing multiple sets of motor drives, do not connect the grounds of the motor drives in series.

As shown below

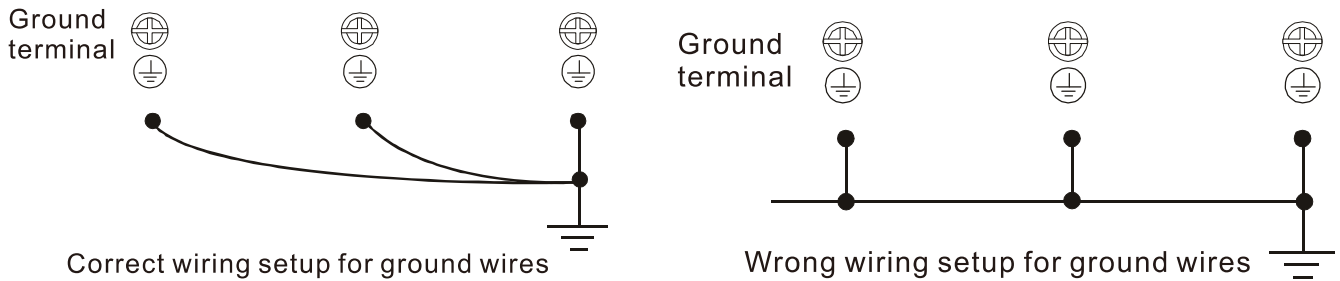

Pay particular attention to the following points:

- ☑ After turning on the main power, do not cut the RFI short-circuit cable while the power is on.
- ☑ Make sure the main power is turned off before cutting the RFI short-circuit cable.
- ☑ Cutting the RFI short-circuit cable will also cut off the conductivity of the capacitor. Gap discharge may occur once the transient voltage exceeds 1000V.

If the RFI short-circuit cable is cut, there will no longer be reliable electrical isolation. In other words, all controlled input and outputs can only be seen as low-voltage terminals with basic electrical isolation. Also, when the internal RFI capacitor is cut off, the motor drive will no longer be electromagnetic compatible.

- ☑ The RFI short-circuit cable may not be cut off if the main power is a grounded power system.
- ☑ The RFI short-circuit cable has to be cut off while conducting high voltage tests. When conducting a high voltage test to the entire facility, the main power and the motor must be disconnected if leakage current is too high.

Floating Ground System (IT Systems)

A floating ground system is also called IT system, ungrounded system, or high impedance/resistance (greater than 30Ω) grounding system.

- ☑ Disconnect the ground cable from the internal EMC filter.
- ☑ In situations where EMC is required, check whether there is excess electromagnetic radiation affecting nearby low-voltage circuits. In some situations, the adapter and cable naturally provide enough suppression. If in doubt, install an extra electrostatic shielded cable on the power supply side between the main circuit and the control terminals to increase security.
- ☑ Do not install an external RFI/EMC filter, the EMC filter will pass through a filter capacitor, thus connecting power input to ground. This is very dangerous and can easily damage the motor drive.

Asymmetric Ground System (Corner Grounded TN Systems)

Caution: Do not cut the RFI short-circuit cable while the input terminal of the motor drive carries power.

In the following four situations, the RFI short-circuit cable must be cut off. This is to prevent the system from grounding through the RFI capacitor, damaging the motor drive.

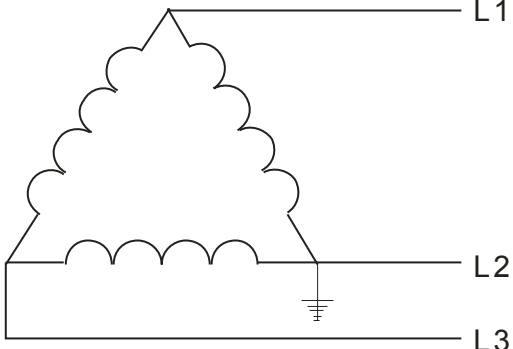
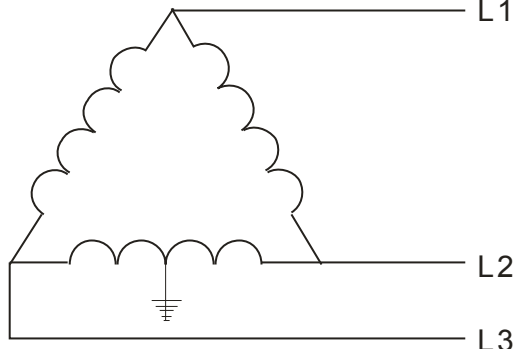
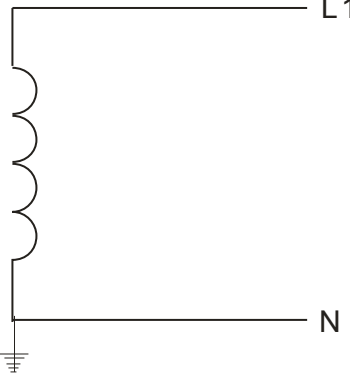
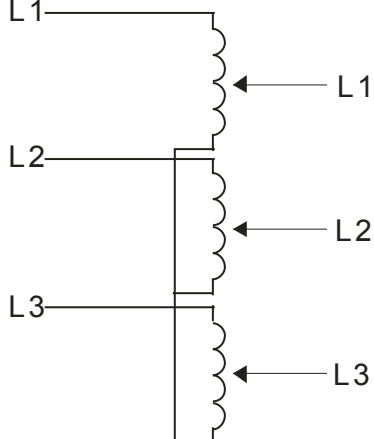
RFI short-circuit cable must be cut off	
<p>1. Grounding at a corner in a triangle configuration</p> 	<p>2. Grounding at a midpoint in a polygonal configuration</p> 
<p>3. Grounding at one end in a single-phase configuration</p> 	<p>4. No stable neutral grounding in a three-phase autotransformer configuration</p> 

Use RFI short-circuit

Internal grounding through RFI capacitor, which reduces electromagnetic radiation. In a situation with higher requirements for electromagnetic compatibility, and using a symmetrical grounding power system, an EMC filter can be installed. For example, the diagram on the right is a symmetrical grounding power system.

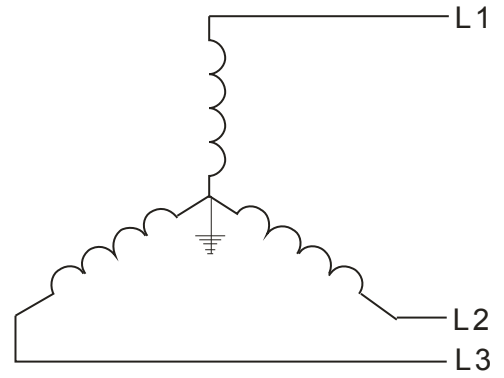

1-7 Dimensions

Frame B

VFD022ED21S, VFD037ED21S, VFD040ED23S/43S

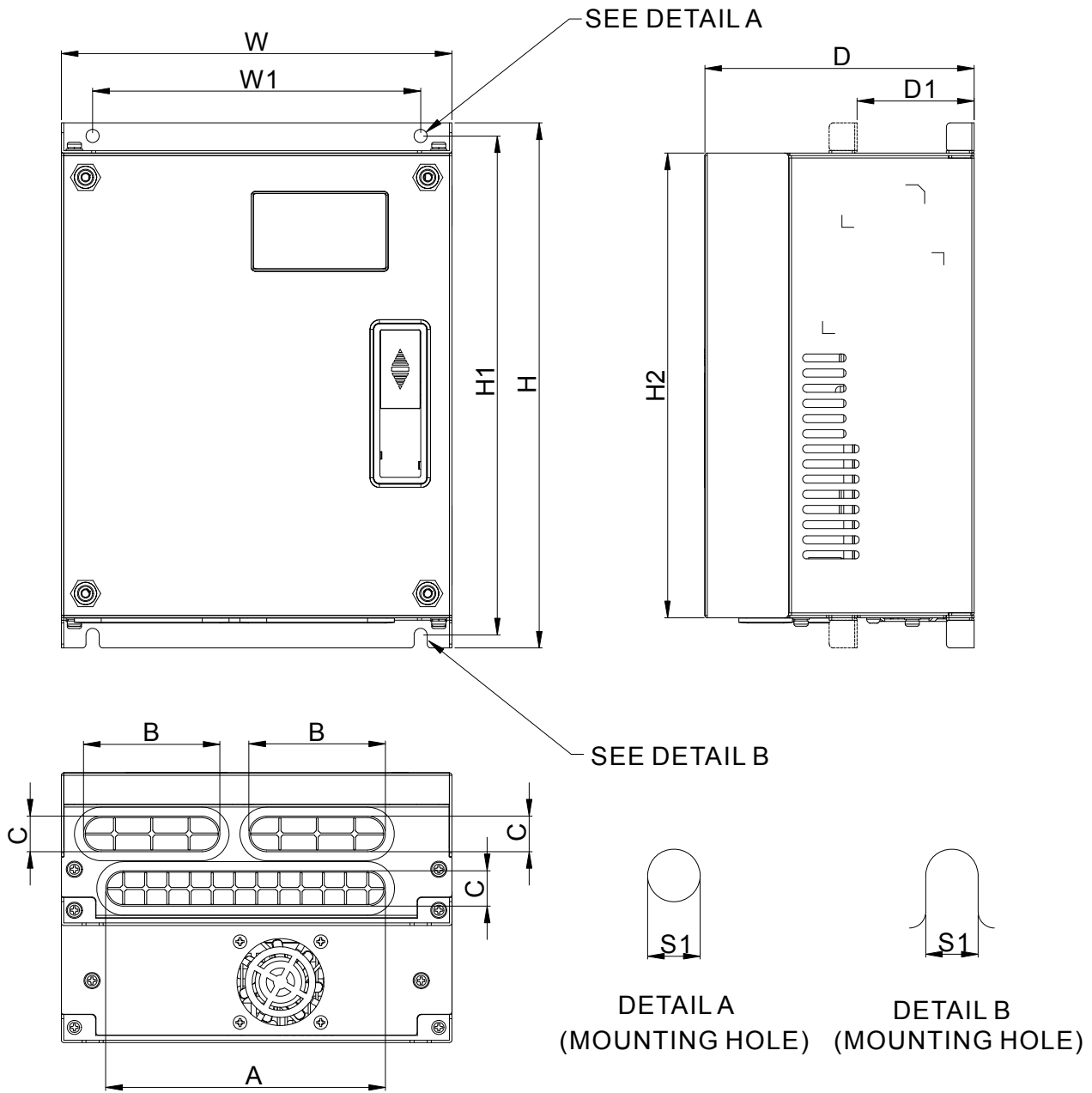

DIMENSIONAL

UNIT:mm[inch]

FRAME	W	W1	H	H1	H2	D	D1*	S1	A	B	C
B	193.5 [7.60]	162.5 [6.39]	260.0 [10.22]	247.0 [9.71]	230.0 [9.04]	133.5 [5.25]	58.0 [2.28]	6.5 [0.26]	138.6 [5.46]	67.6 [2.66]	17.6 [0.69]

*D1: This dimension is for flange mounting application reference

Frame C

VFD055ED23S/43S, VFD075ED23S/43S, VFD110ED23S/43S, VFD150ED43S, VFD185ED43S

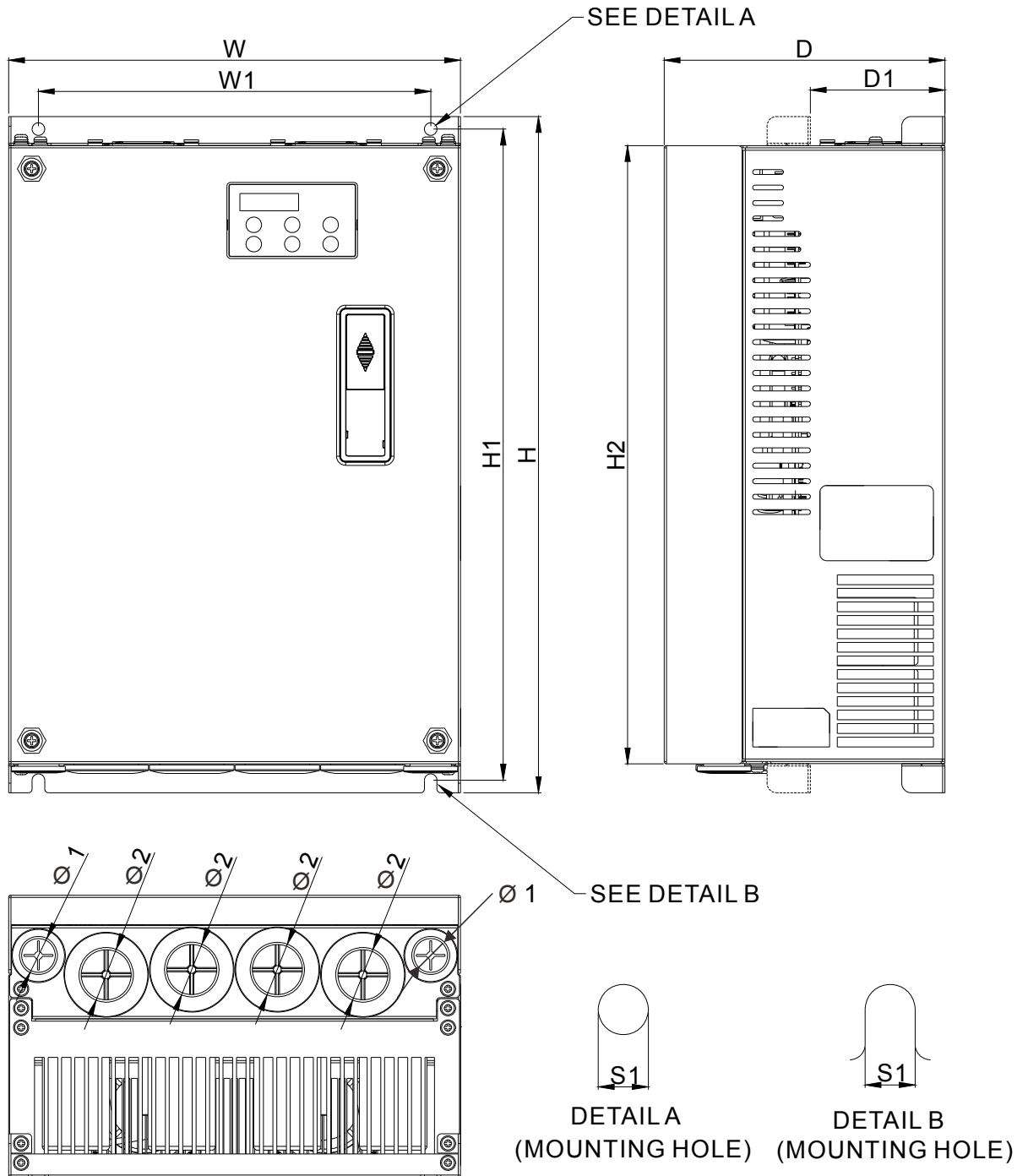

DIMENSIONAL

UNIT:mm[inch]

FRAME	W	W1	H	H1	H2	D	D1*	S1	Ø1	Ø2
C	235.0 [9.25]	204.0 [8.03]	350.0 [13.78]	337.0 [13.27]	320.0 [15.60]	146.0 [5.75]	70.0 [2.76]	6.5 [0.26]	19.7 [0.78]	28.3 [1.11]

*D1: This dimension is for flange mounting application reference

Frame D

VFD150ED23S, VFD185ED23S, VFD220ED23S/43S, VFD300ED43S

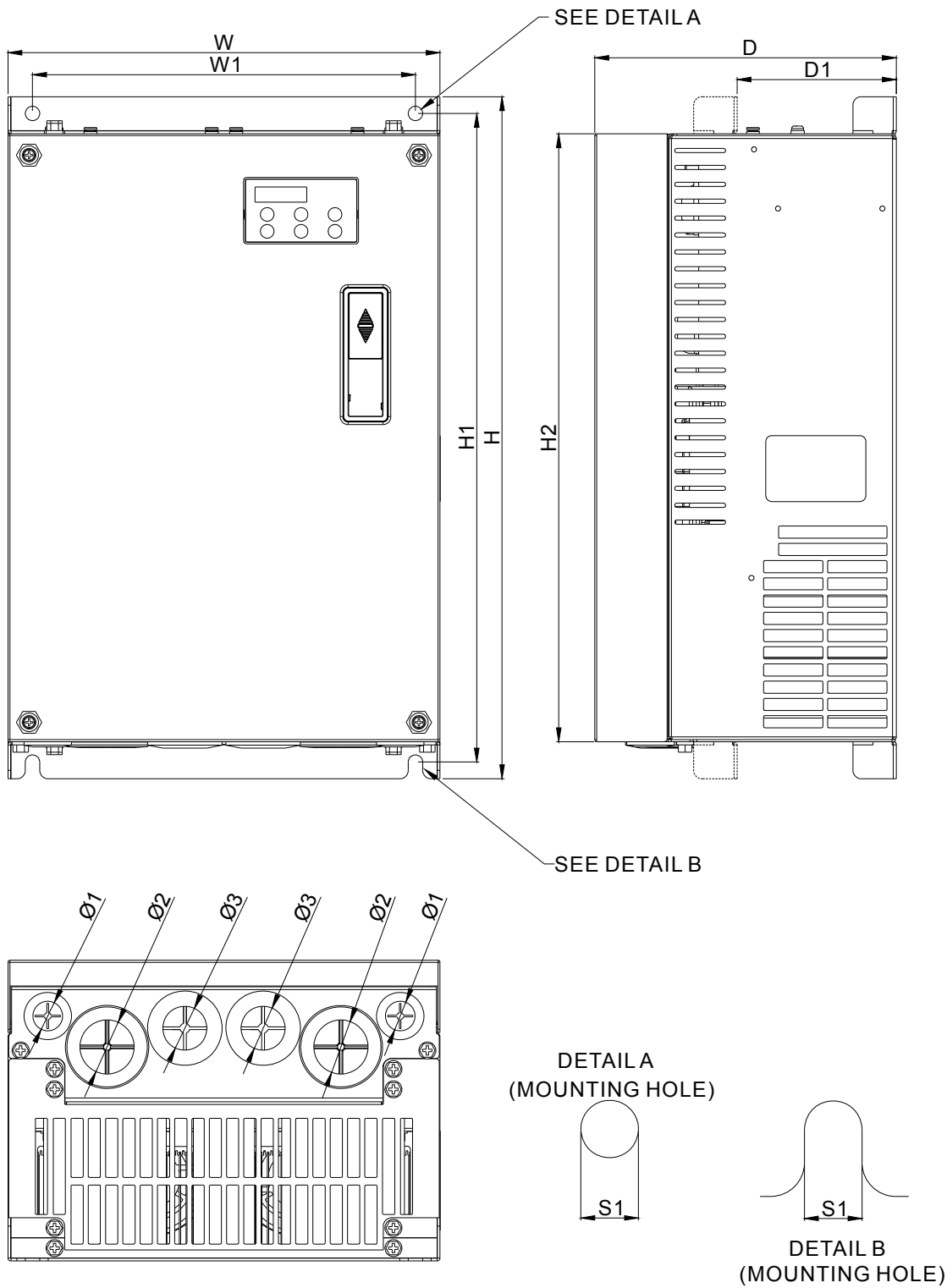

DIMENSIONAL

UNIT:mm[inch]

FRAME	W	W1	H	H1	H2	D	D1*	S1	Ø1	Ø2	Ø3
D	255.0 [10.04]	226.0 [8.90]	403.8 [15.90]	384.0 [15.12]	360.0 [14.17]	178.0 [7.01]	94.0 [3.70]	8.5 [0.33]	17.5 [0.69]	32.0 [1.26]	26.0 [1.02]

*D1: This dimension is for flange mounting application reference

Frame E

VFD300ED23S, VFD370ED23S/43S, VFD450ED43S, VFD550ED43S, VFD750ED43S

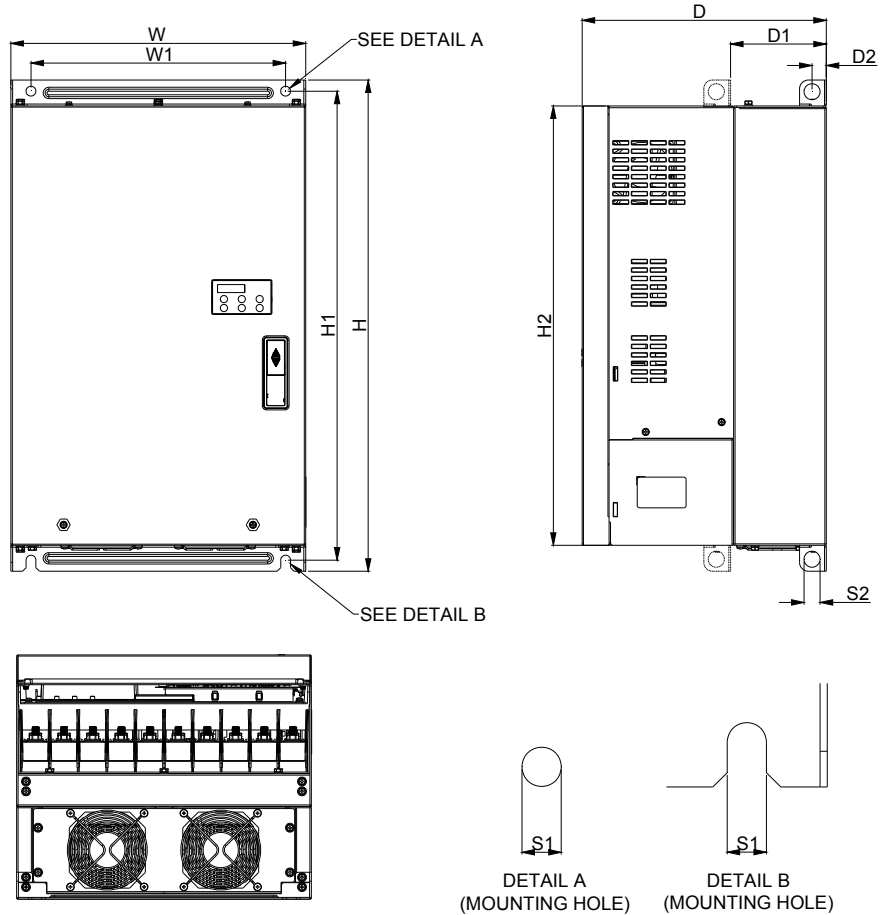

DIMENSIONAL

UNIT:mm[inch]

FRAME	W	W1	H	H1	H2	D	D1*	D2	S1	S2
E	330.0 [12.99]	285.0 [11.22]	550.0 [21.65]	525.0 [20.67]	492.0 [19.37]	273.4 [10.76]	107.2 [4.22]	16.0 [0.63]	11.0 [0.43]	18.0 [0.71]

*D1: This dimension is for flange mounting application reference.

Built-In Digital Keypad

KPED-LE01

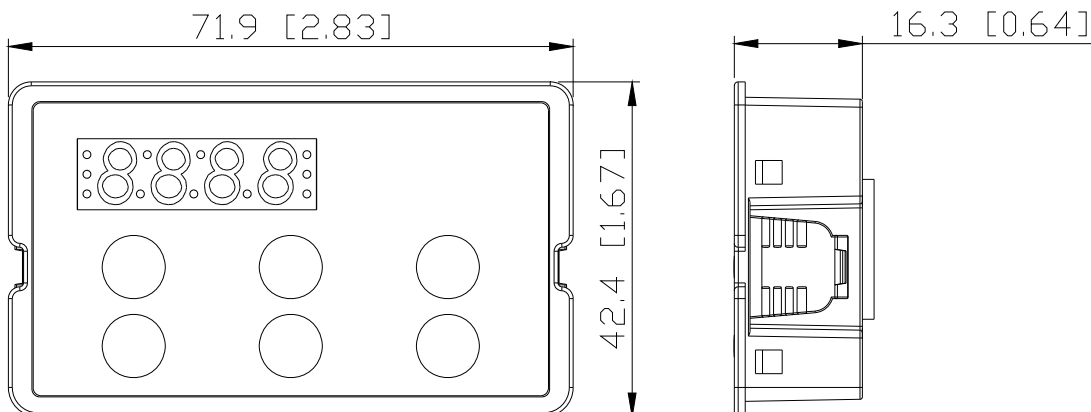

02 Installation

2-1 About Installation

NOTE

- ❑ Prevent fiber particles, scraps of paper, shredded wood saw dust, metal particles, etc. from adhering to the heat sink
- ❑ Install the AC motor drive in a metal cabinet. When installing one drive below another one, use a metal separation between the AC motor drives to prevent mutual heating and to prevent the risk of fire accident.
- ❑ Install the AC motor drive in Pollution Degree 2 environments only: normally only nonconductive pollution occurs and temporary conductivity caused by condensation is expected.

The image below is for reference only.

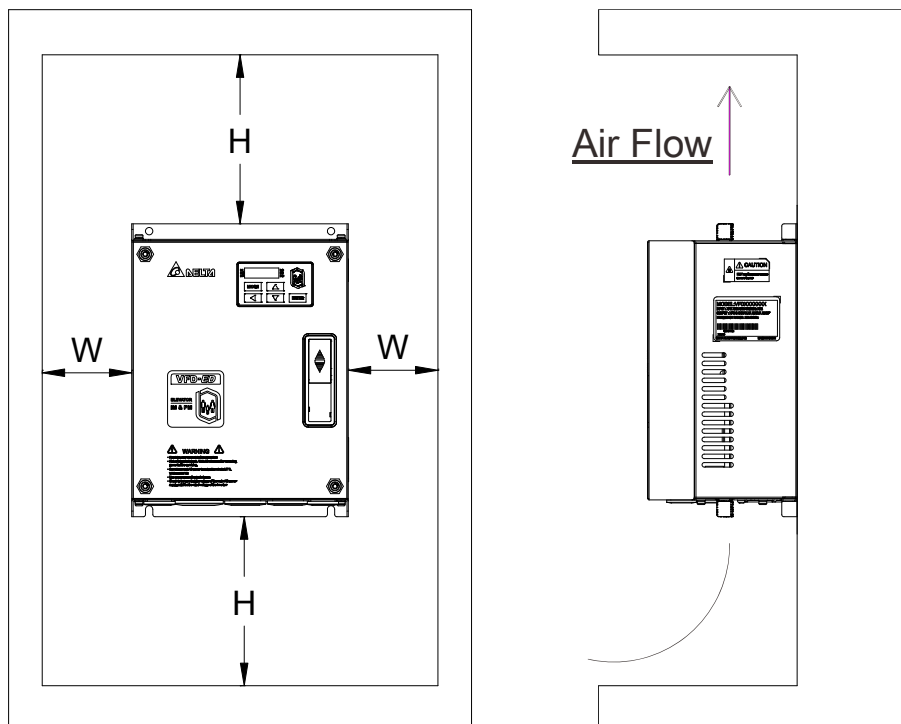

2-2 Minimum mounting clearance

Horsepower	Width	Height
	mm (inch)	mm (inch)
3-5HP	50 (2)	150 (6)
7.5-20HP	75 (3)	175 (7)
25-30HP	75 (3)	200 (8)
40-100HP	75(3)	200(8)

Frame	Capacity	Model No.
B	3.0-5.0HP (2.2-4kW)	VFD022ED21S, VFD037ED21S, VFD040ED23S/43S
C	7.5-15HP (5.5-11kW)	VFD055ED23S/43S, VFD075ED23S/43S, VFD110ED23S/43S, VFD150ED43S, VFD185ED43S
D	20-40HP (15-30kW)	VFD150ED23S, VFD185ED23S, VFD220ED23S/43S VFD300ED43S
E	40-100HP (30-75kW)	VFD300ED23S, VFD370ED23S/43S, VFD450ED43S, VFD550ED43S, VFD750ED43S

NOTE

The minimum mounting clearances stated in the table above applies to AC motor drives frame B, C, D and E. A drive which fails to follow the minimum mounting clearances may cause the fan to malfunction and heat dissipation problem.

Model No.	Air flow rate for cooling						Power Dissipation AC motor drive		
	Flow Rate(cfm)			Flow Rate(m3/hr)			Power Dissipation		
	External	Internal	Total	External	Internal	Total	Loss External (Heat Sink)	Internal	Total
VFD022ED21S	13.7	-	13.7	23.3	-	23.3	60	36	96
VFD037ED21S	23.9	-	23.9	40.7	-	40.7	84	46	130
VFD040ED23S	23.9	-	23.9	40.7	-	40.7	133	49	182
VFD055ED23S	48.5	-	48.5	82.4	-	82.4	212	67	279
VFD075ED23S	48.5	-	48.5	82.4	-	82.4	292	86	379
VFD110ED23S	47.9	-	47.9	81.4	-	81.4	355	121	476
VFD150ED23S	64.6	-	64.6	109.8	-	109.8	490	161	651
VFD185ED23S	102.3	-	102.3	173.8	-	173.8	638	184	822
VFD220ED23S	102.8	-	102.8	174.7	-	174.7	723	217	939
VFD300ED23S	179	30	209	304	51	355	932	186	1118
VFD370ED23S	179	30	209	304	51	355	1112	222	1334
VFD040ED43S	13.7	-	13.7	23.3	-	23.3	123	42	165
VFD055ED43S	48.5	-	48.5	82.4	-	82.4	185	55	240
VFD075ED43S	48.5	-	48.5	82.4	-	82.4	249	71	320

VFD110ED43S	47.9	-	47.9	81.4	-	81.4	337	94	431
VFD150ED43S	46.1	-	46.1	78.4	-	78.4	302	123	425
VFD185ED43S	46.1	-	46.1	78.4	-	78.4	391	139	529
VFD220ED43S	102.8	-	102.8	174.7	-	174.7	642	141	783
VFD300ED43S	83.7	-	83.7	142.2	-	142.2	839	180	1019
VFD370ED43S	179	30	209	304	51	355	803	252	1055
VFD450ED43S	179	30	209	304	51	355	1014	270	1284
VFD550ED43S	179	30	209	304	51	355	1244	275	1519
VFD750ED43S	186	30	216	316	51	367	1541	338	1878

Derating Capacity of Carrier Frequency (Fc):

Frame	B	C	D	E	E
Fc(kHz)	2.2~4 kW	5.5~11 kW	15~22 kW	30~45 kW	55~75kW
0	100%	100%	100%	100%	100%
1	100%	100%	100%	100%	100%
2	100%	100%	100%	100%	100%
3	100%	100%	100%	100%	100%
4	100%	100%	100%	100%	100%
5	100%	100%	100%	100%	100%
6	100%	100%	100%	100%	100%
7	100%	100%	100%	90.73%	-
8	100%	100%	100%	82.20%	-
9	94.24%	100%	92.32%	74.31%	-
10	88.92%	100%	85.21%	-	-
11	82.54%	95.35%	78.63%	-	-
12	78.08%	91.02%	72.53%	-	-
13	73.95%	86.98%	66.87%	-	-
14	70.14%	84.14%	61.62%	-	-
15	66.61%	80.67%	56.74%	-	-

Derating Curve of Carrier Frequency (Fc):

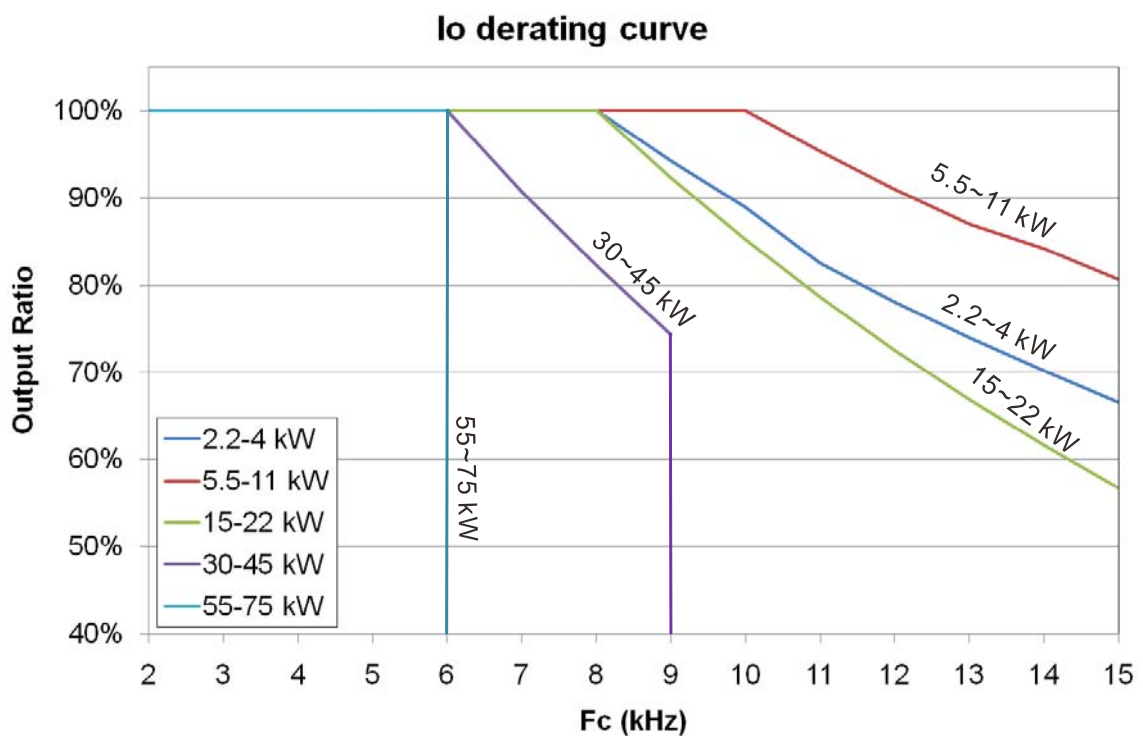

Ambient Temperature Derating Curve:

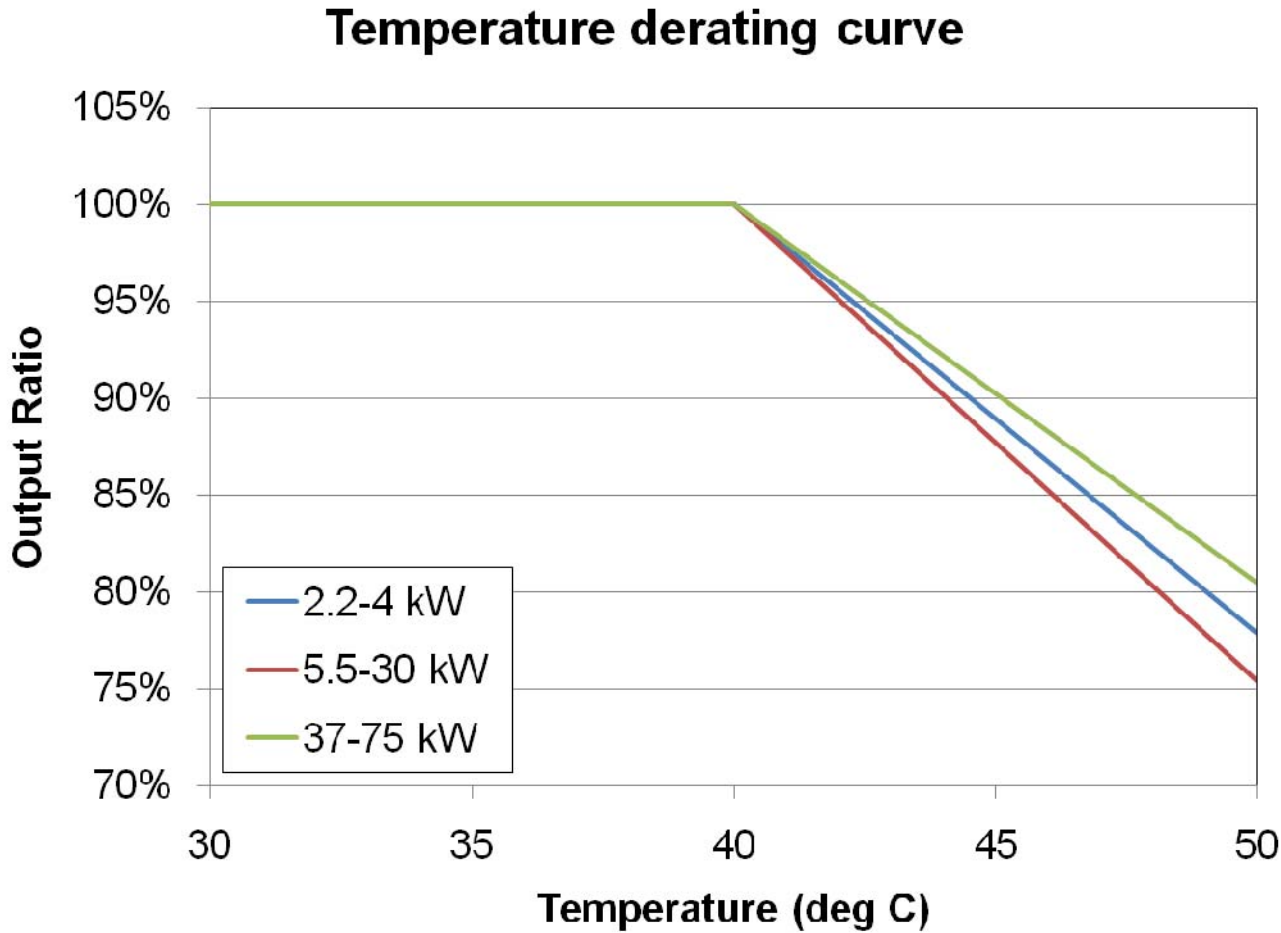

Altitude Derating Curve:

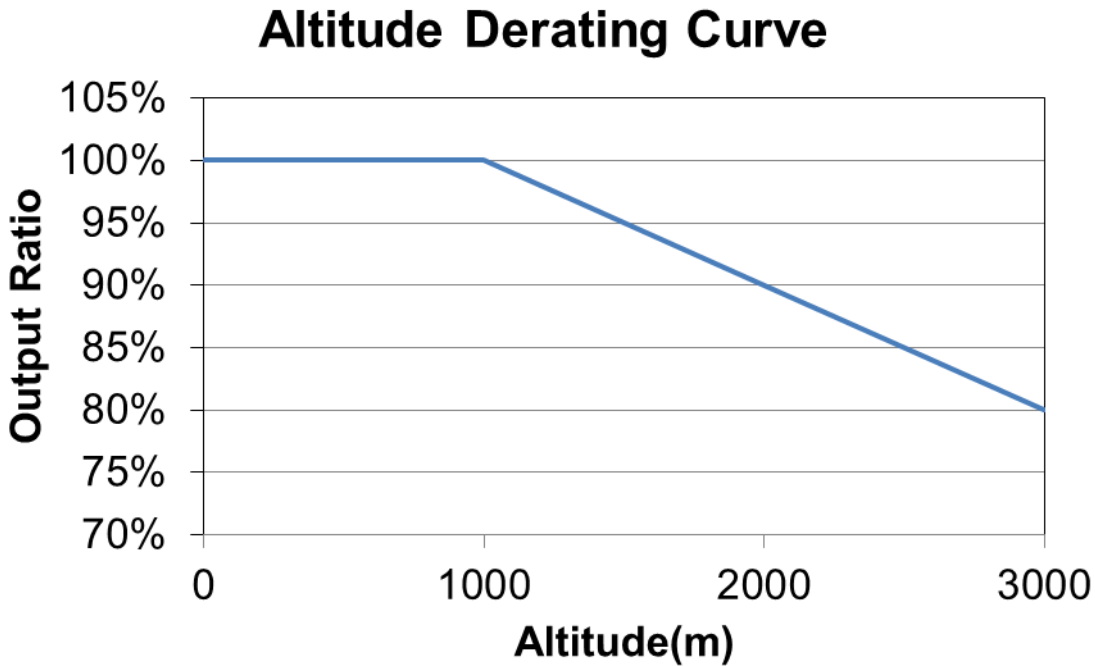

03 Wiring

After removing the front cover, examine if the power and control terminals are clearly noted. Read following precautions before wiring.

- ☑ Make sure that power is only applied to the R/L1, S/L2, and T/L3 terminals. Failure to comply may result in damage to the equipment. The voltage and current should lie within the range as indicated on the nameplate (Chapter 1-1).
- ☑ All the units must be grounded directly to a common ground terminal to prevent lightning strike or electric shock.
- ☑ Make sure to fasten the screw of the main circuit terminals to prevent sparks which is made by the loose screws due to vibration.



- ☑ It is crucial to turn off the AC motor drive power before any wiring installation is made. A charge may still remain in the DC bus capacitors with hazardous voltages even if the power has been turned off therefore it is suggested for users to measure the remaining voltage before wiring. For your personal safety, do not perform any wiring before the voltage drops to a safe level < 25 Vdc. Wiring installation with remaining voltage condition may cause sparks and short circuit.
- ☑ Only qualified personnel familiar with AC motor drives is allowed to perform installation, wiring and commissioning. Make sure the power is turned off before wiring to prevent electric shock.



- ☑ When wiring, please choose the wires with specification that comply with local regulation for your personal safety.
- ☑ Check following items after finishing the wiring:
 1. Are all connections correct?
 2. Any loosen wires?
 1. Any short-circuits between the terminals or to ground?

3-1 Wiring

Wiring Diagram of Frame B

It provides 3-phase power

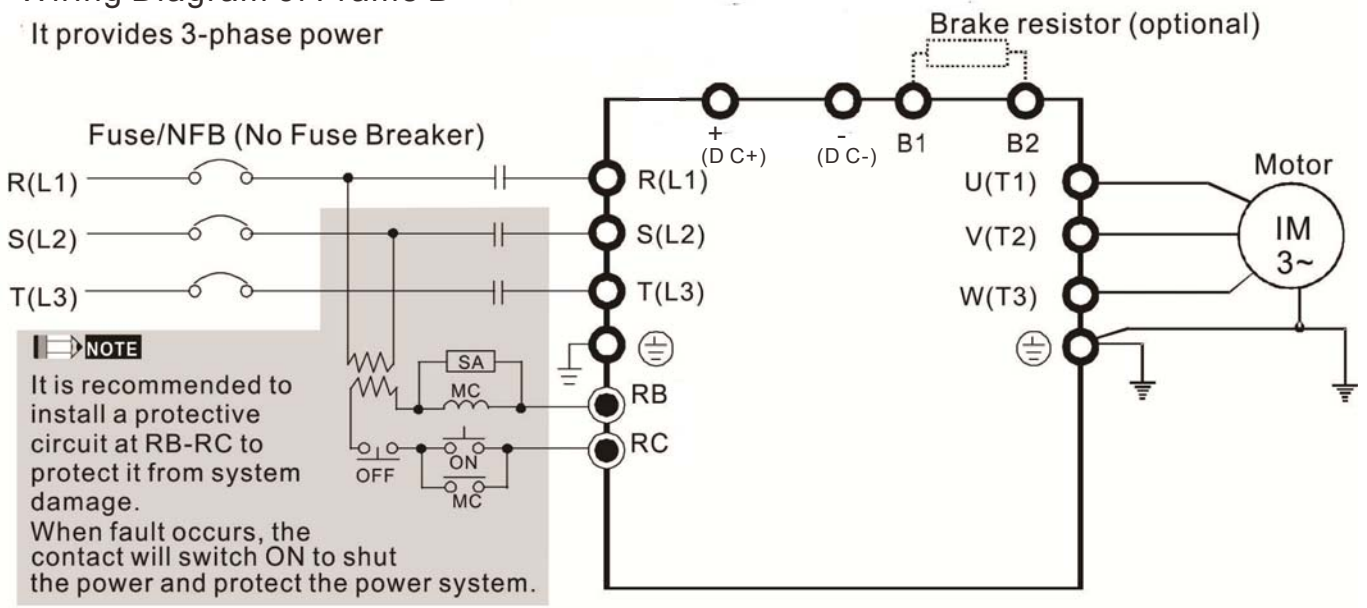

NOTE
RB and RC are the multifunction output terminals

Wiring Diagram of Frame C & D

It provides 3-phase power

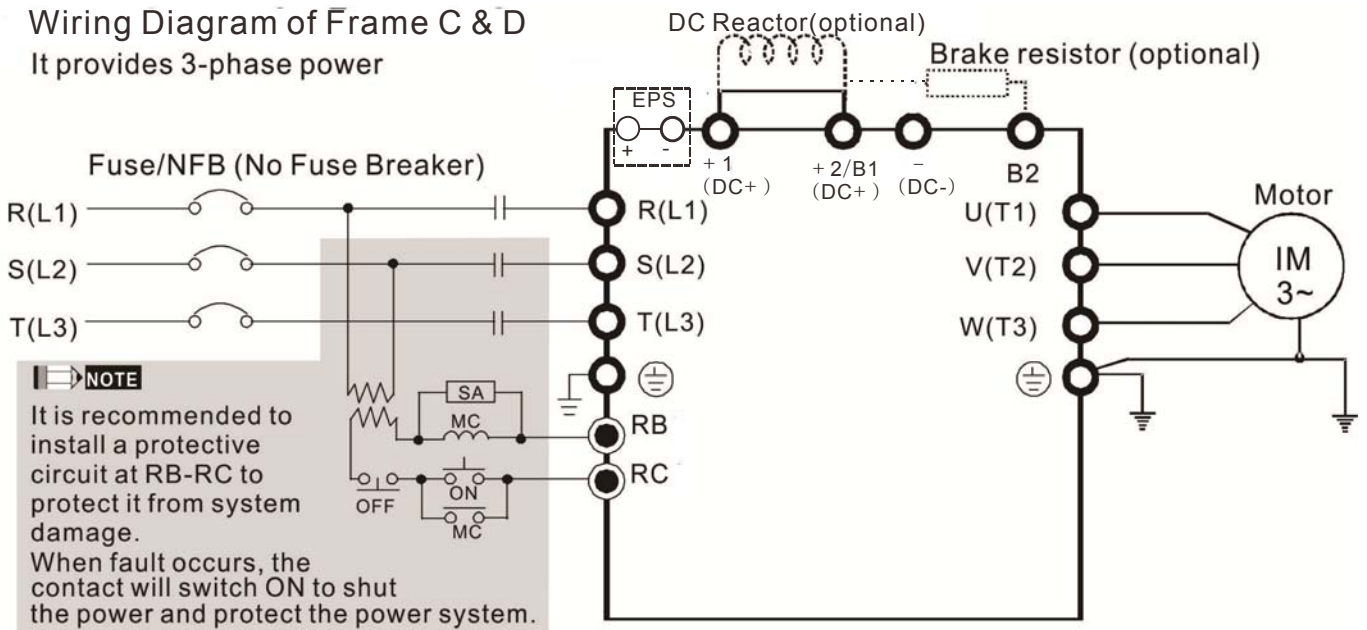

NOTE
RB and RC are the multi-function output terminals.

Wiring Diagram of Frame E

It provides 3-phase power.

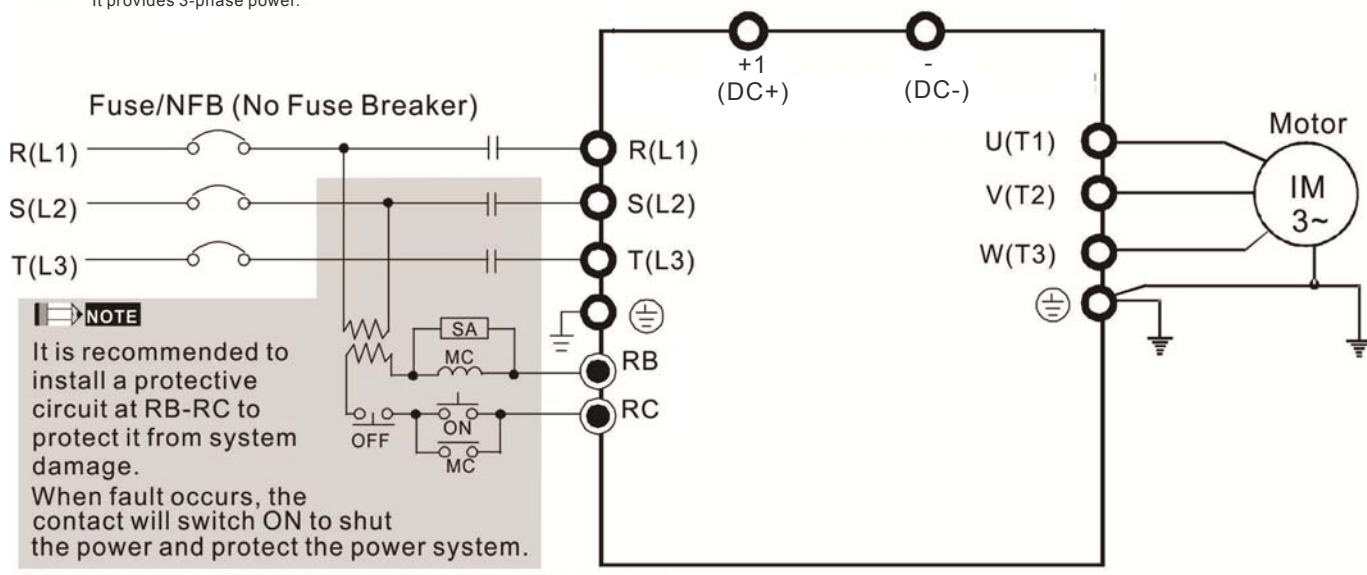

NOTE

It is recommended to install a protective circuit at RB-RC to protect it from system damage. When fault occurs, the contact will switch ON to shut the power and protect the power system.

NOTE

RB and RC are multi-function output terminals.

See page 3-5 for the wiring diagram of Emergency Power Supply (EPS).

Factory setting: NPN(SINK) Mode
Refer to figure 1 for wiring of NPN & PNP mode

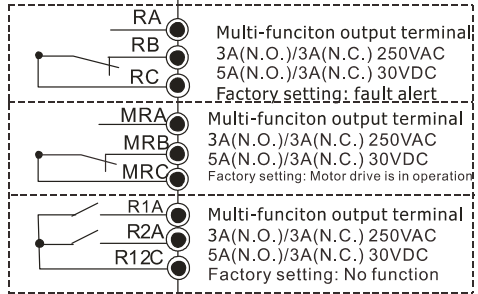
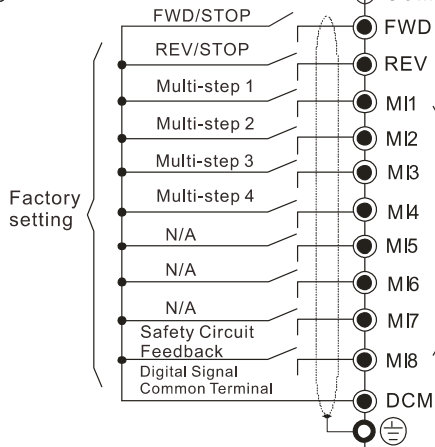

Multi-function Input Terminal

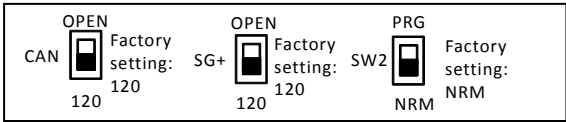
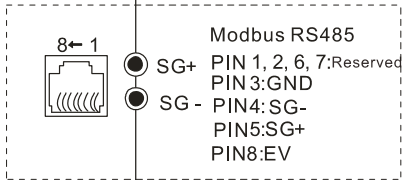
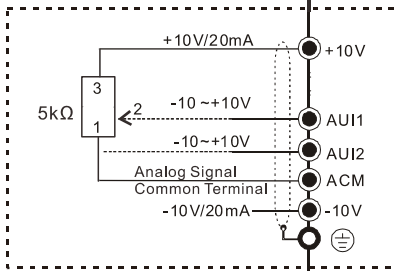
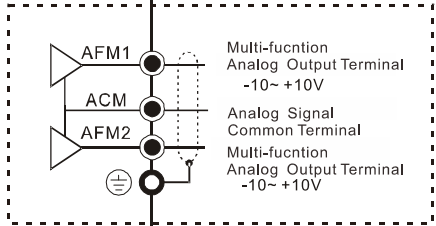
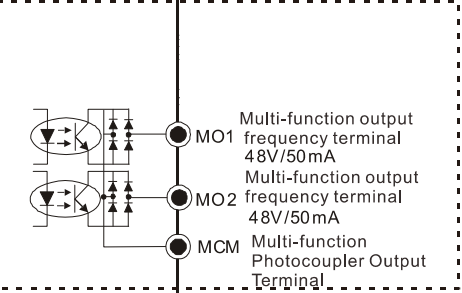
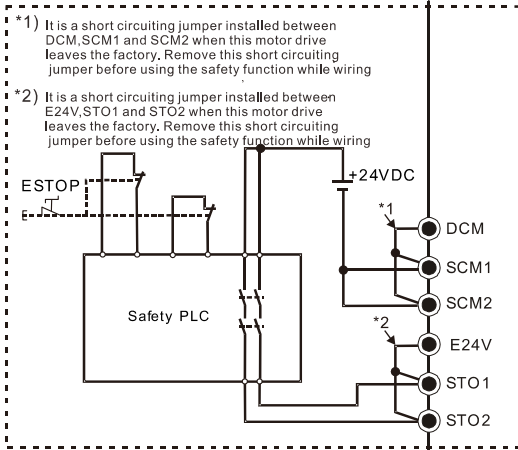
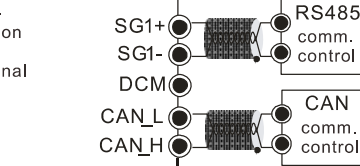

I/O card Expansion slot

PG card Expansion slot

Figure 1

Switching between two modes: SINK(NPN) /SOURCE(PNP)

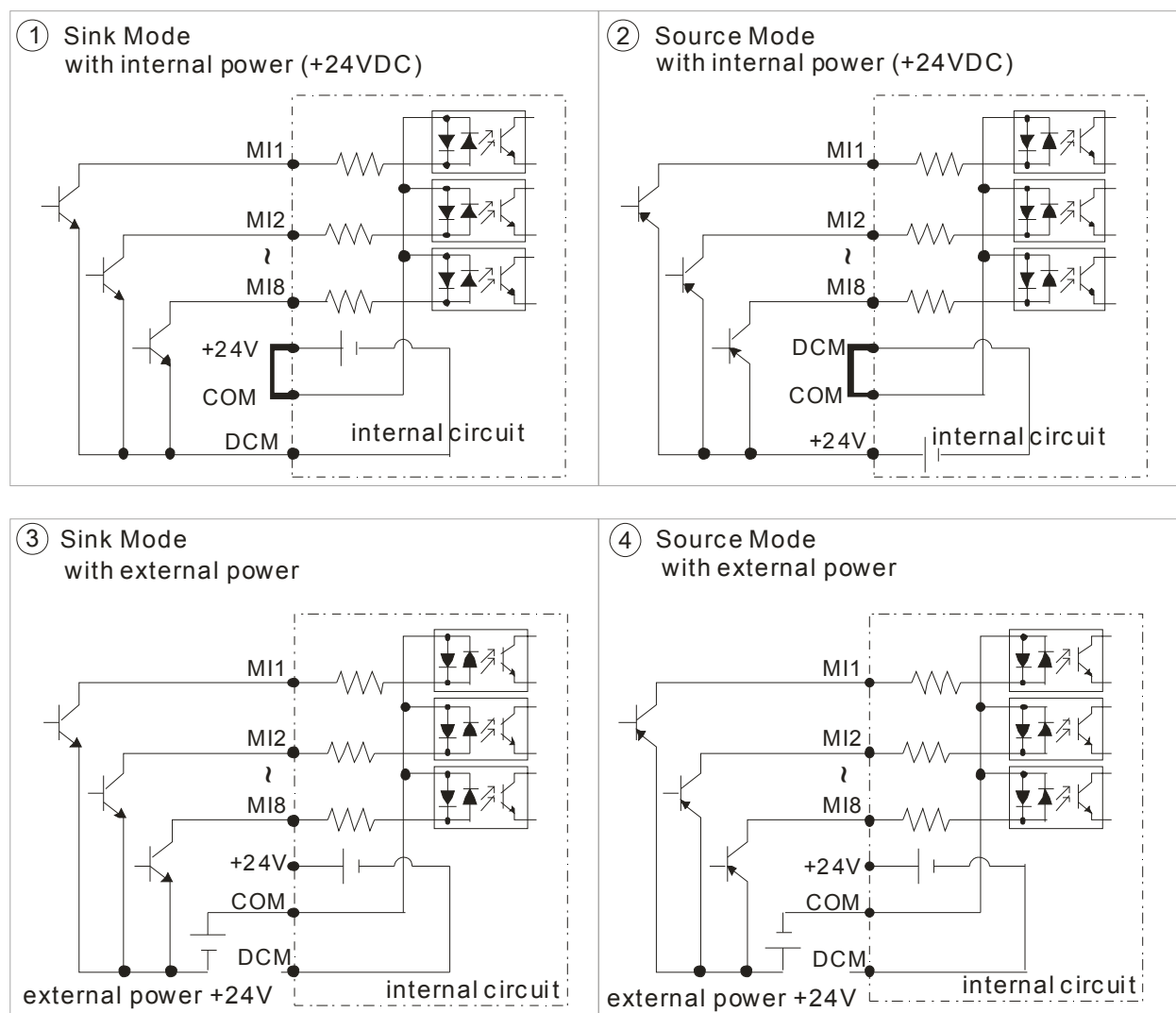
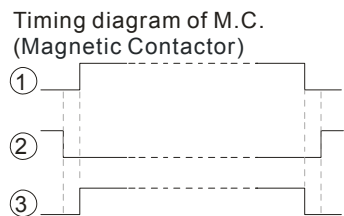
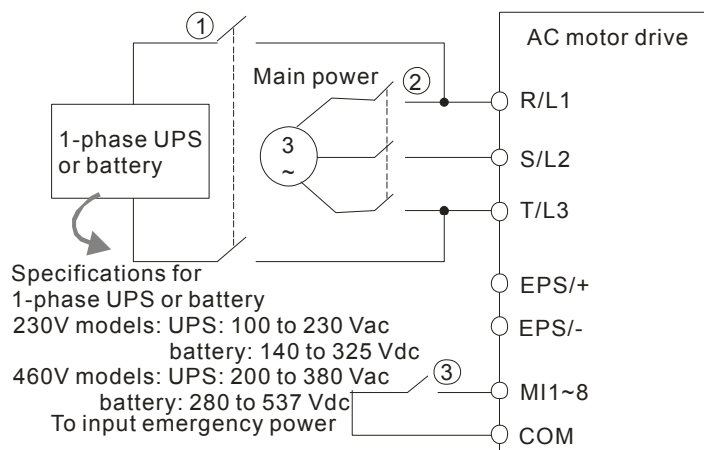

Figure 2. Emergency Power Supply (EPS) system wiring diagrams

For Frame B, C, D & E:

(1) Single phase UPS or battery can only be used on the main power supply



- Before using emergency power, close M.C. ①, M.C. ③ and keep, M.C. ② open.
- Close M.C. ① before you close M.C. ③.
- Before removing the battery, open M.C. ① and M.C. ③.
- Before you close M.C. ②, open M.C. ① and M.C. ③.

For Frame C & D:

(2) When the voltage of the main power supply is lower than 140Vdc(230V models) / 280Vdc (460V models), have the control power supply connected to a single phase UPS or a battery.

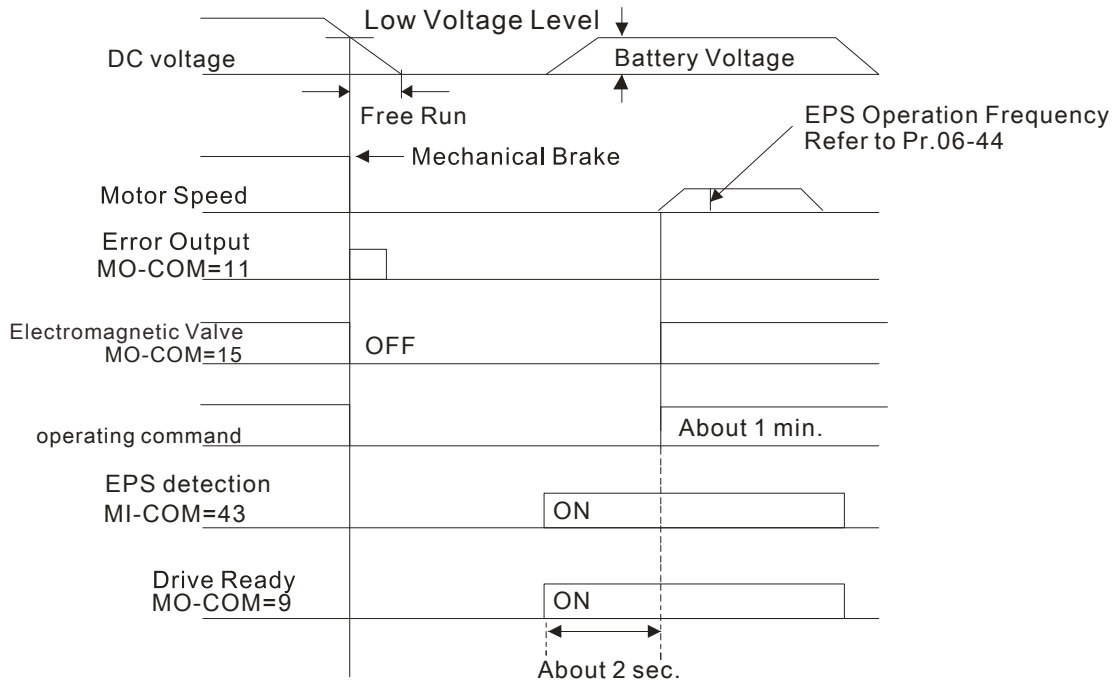
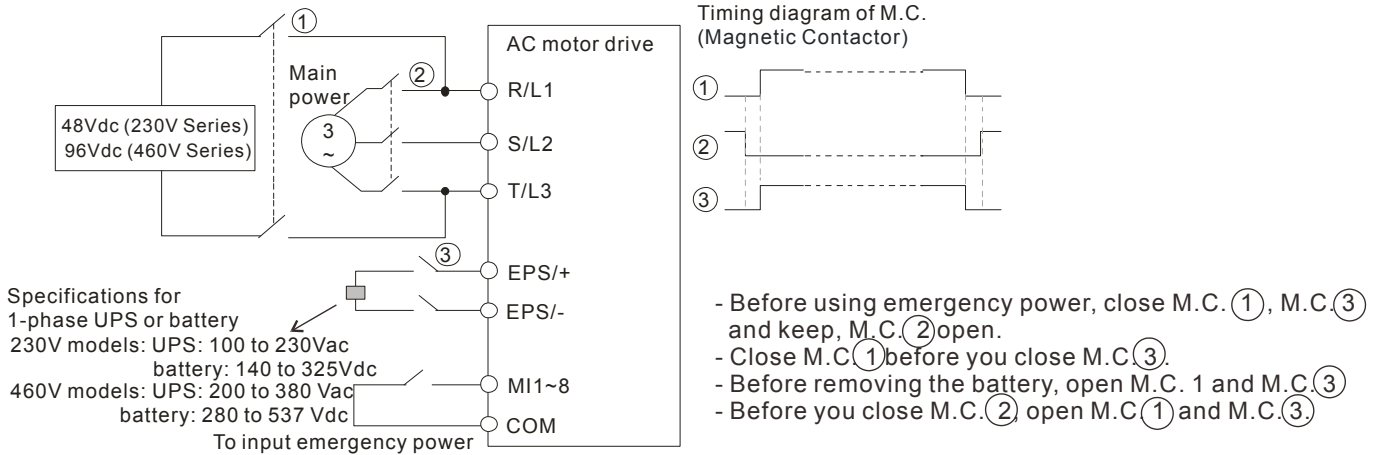

Notes about the emergency power supply (EPS).

Be aware of the following conditions when emergency power is ON:

1. Fan will not run to save energy from EPS.
2. Parameter setting will not be saved. When the power is turned off then applies again, the parameter setting will be gone.
3. Operate by the speed set at Pr.06-44.
4. Protections for low voltage and phase loss in NOT available.
5. Display DC-BUS voltage by Pr.06-29

3-2 System Wiring Diagram

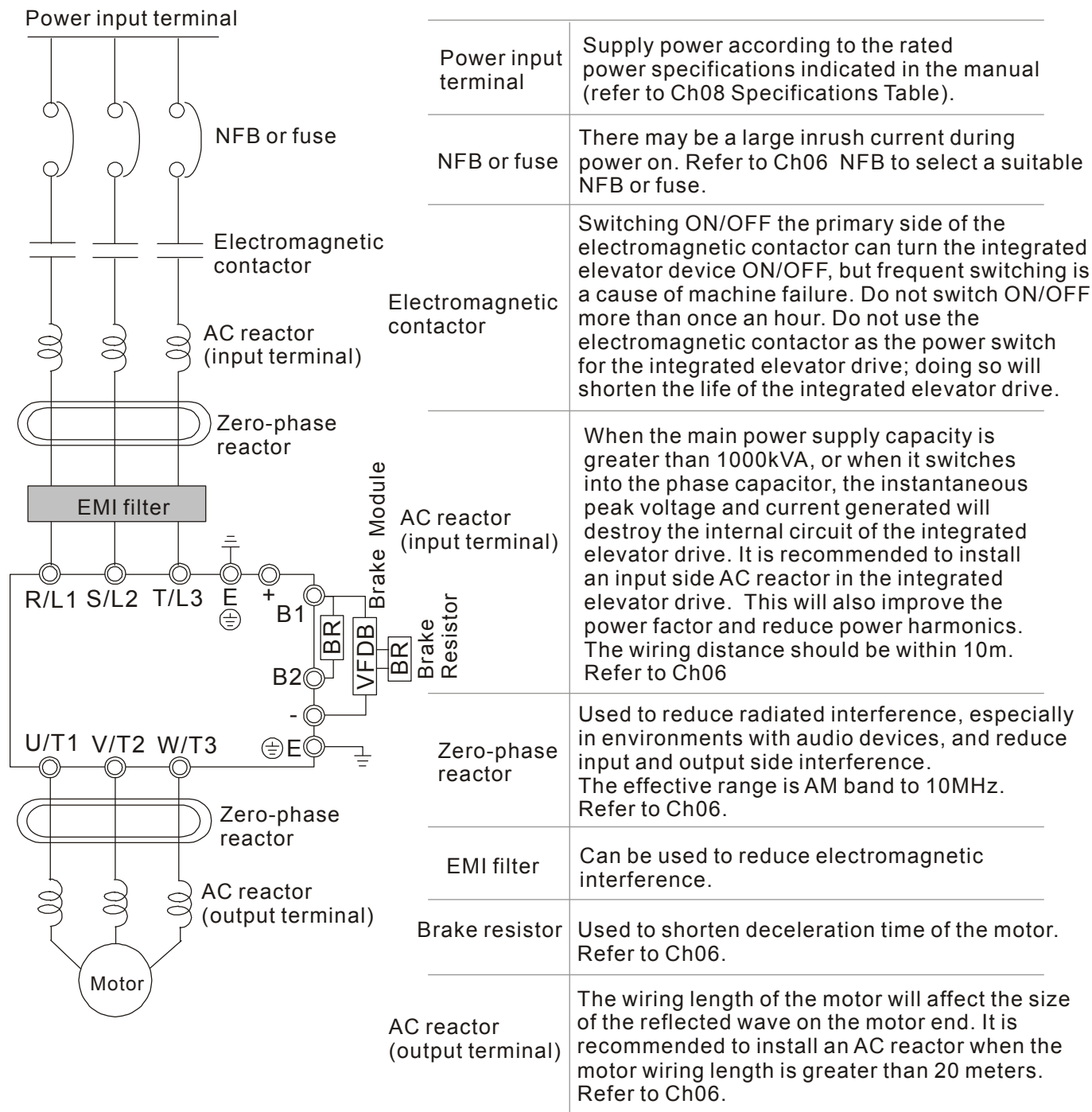

04 Main Circuit Terminals



Main input power terminals:

- ☑ Do not connect 3-phase model to one-phase power. R/L1, S/L2 and T/L3 has no phase-sequence requirement, it can be used upon random selection.
- ☑ A NFB must be installed between the 3-phase power input terminals and the main circuit terminals (R/L1, S/L2, T/L3). It is recommended to add a magnetic contactor (MC) to the power input wiring to cut off power quickly and reduce malfunction when activating the protection function of the AC motor drive. Both ends of the MC should have an R-C surge absorber.
- ☑ Fasten the screws in the main circuit terminal to prevent sparks condition made by the loose screws due to vibration.
- ☑ Use voltage and current within the specification in Chapter 8.
- ☑ When using a general ELB (Earth Leakage Breaker), select a current sensor with sensitivity of 200mA or above and not less than 0.1-second operation time to avoid nuisance tripping. When choosing an ELB designed for the AC motor drive, choose a current sensor with sensitivity of 30mA or above.
- ☑ Use the shield wire or tube for the power wiring and ground the two ends of the shield wire or tube.
 - ☑ Do NOT run/stop AC motor drives by turning the power ON/OFF. Run/stop AC motor drives by sending RUN/STOP command via control terminals or keypad. If you still need to run/stop AC motor drives by turning power ON/OFF, it is recommended to do so only ONCE per hour

Output terminals of the main circuit:

- ☑ When it is necessary to install a filter at the output side of terminals U/T1, V/T2, W/T3 on the AC motor drive. Use inductance filter. Do not use phase-compensation capacitors or L-C (Inductance-Capacitance) or R-C (Resistance-Capacitance).
- ☑ DO NOT connect phase-compensation capacitors or surge absorbers at the output terminals of AC motor drives.
- ☑ Use well-insulated motors to prevent any electric leakage from motors.

Terminals [+1, +2] for connecting DC reactor. Terminals [+1, +2/B1] for connecting brake resistor.

- ☑ These terminals are to connect to a DC reactor to improve the power factor and reduce harmonics. At the factory setting, a jumper is connected to these terminals. Remove that jumper before connecting to a DC reactor.

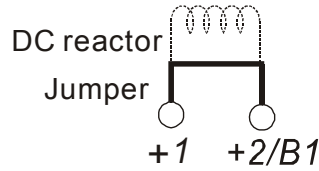

- ☑ Models above 22kW don't have a built-in brake resistor. To improve resistance ability, connect an external, optional brake resistor
- ☑ When not in use, leave terminals +2/B1, (-) open.
- ☑ Short-circuiting [B2] or [-] to [+2/B1] will damage the motor drive. Do NOT do that.

4-1 Main Circuit Diagram

Frame B

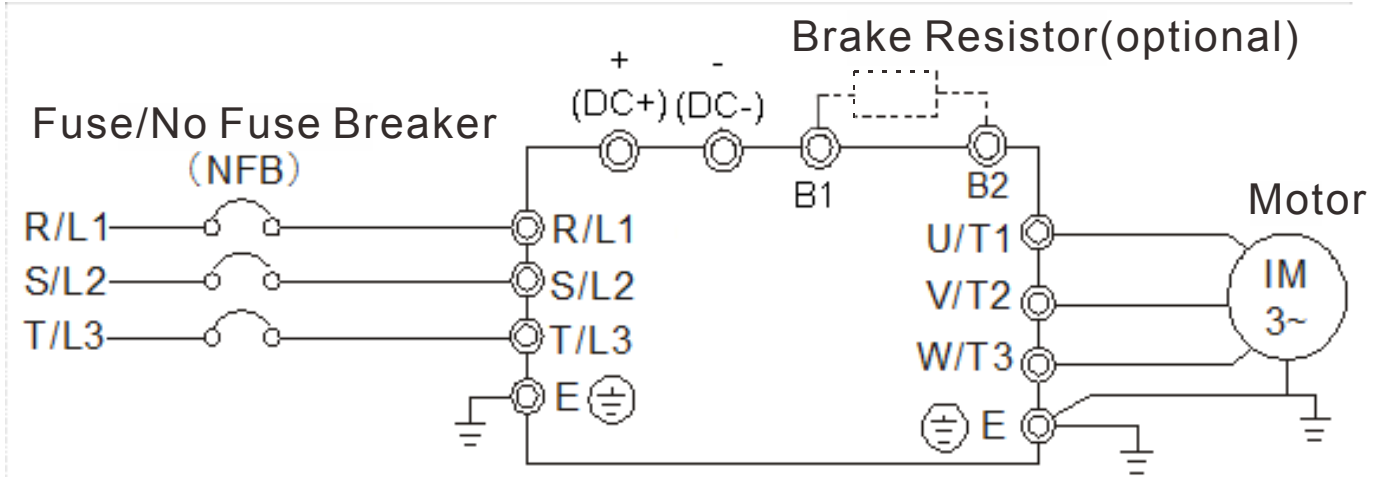

Frame C & D

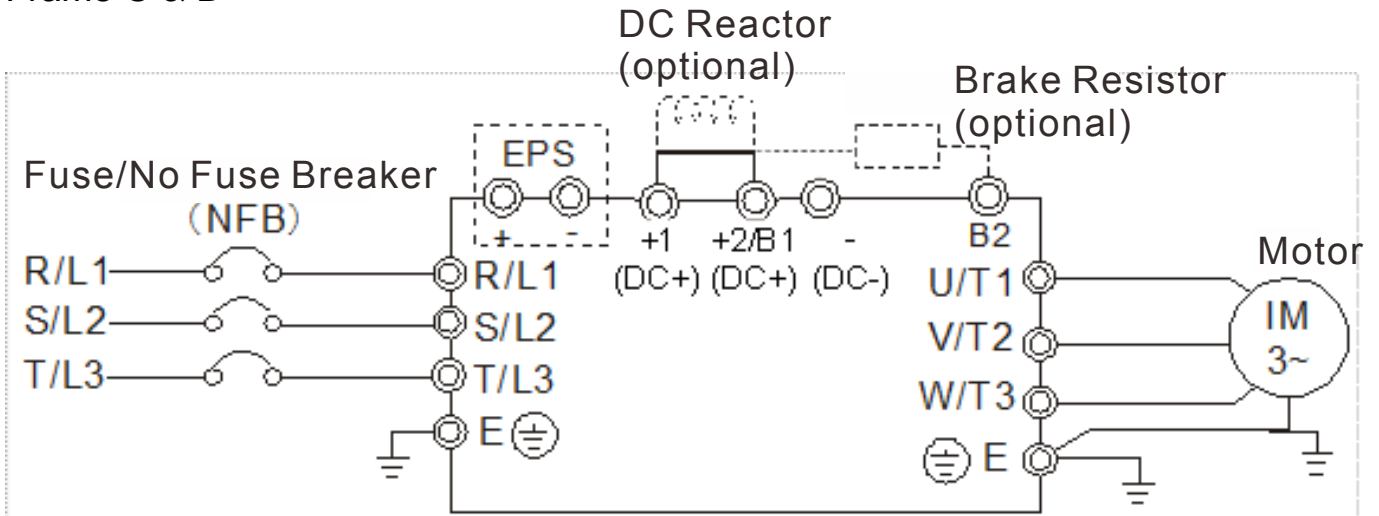

Frame E

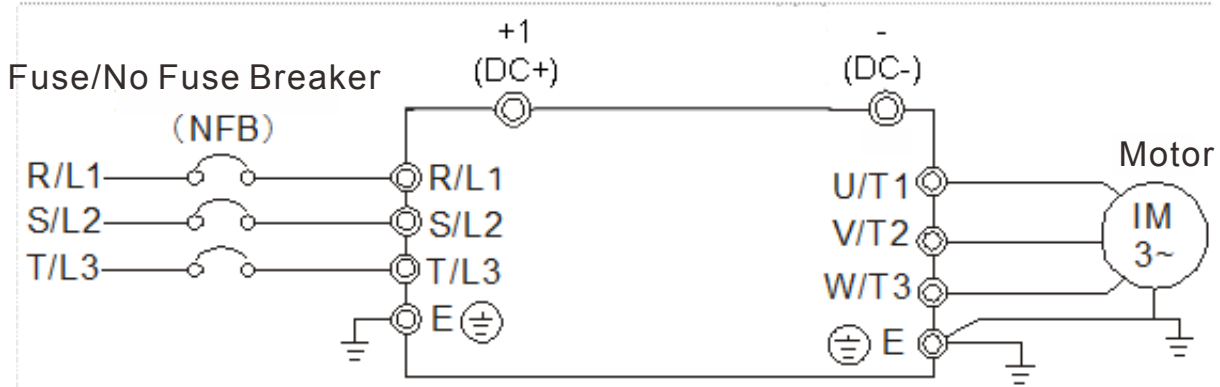

Terminal Symbol	Explanation of Terminal Function
EPS (+, -)	Backup power/ Emergency power connection terminal. *1:EPS (Emergency Power Supply) input terminal supports only frame C & D.
R/L1, S/L2, T/L3	AC line input terminals 3-phase.
U/T1, V/T2, W/T3	AC drive output terminals for connecting 3-phase induction motor.
+1, +2/B1	Connections for DC reactor to improve the power factor. Remove the jumper before installing a DC reactor. (Frame E has a DC reactor built-in.).
+2/B1, B2	Connections for brake resistor (optional).
⊕ E	Earth connection, to comply with local regulations.

4-2 Main Circuit Terminals Specifications

Frame B

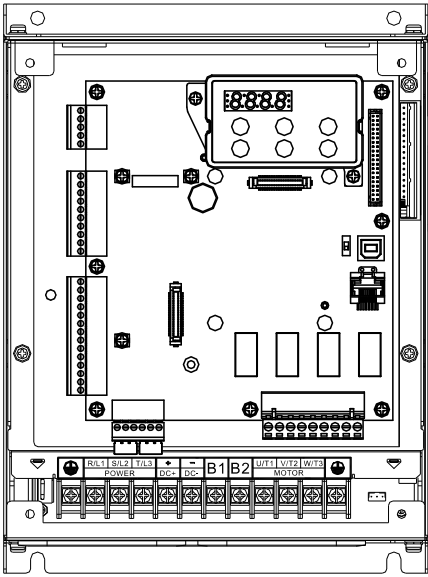

Main circuit terminals:

R/L1, S/L2, T/L3, U/T1, V/T2, W/T3, +(DC+), -(DC-), B1, B2

Models	Wire Gauge		Screw Size & Torque ($\pm 10\%$)
	Max. Wire Gauge	Min. Wire Gauge	
VFD022ED21S	10AWG [5.3mm ²]	14AWG [2.1mm ²]	M4 18 kgf-cm (15.6 lbf-in) (1.7 Nm)
VFD040ED43S		12AWG [3.3mm ²]	
VFD037ED21S			
VFD040ED23S			

UL installations must use 600V, 75°C wire. Use copper wire only.

NOTE:

- Figure 1 shows the terminal specification.
- Figure 2 shows the specification of insulated heat shrink tubing that comply with UL (600V, YDPU2).

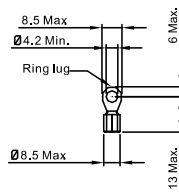

Figure 1

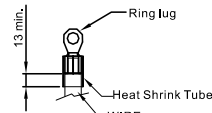
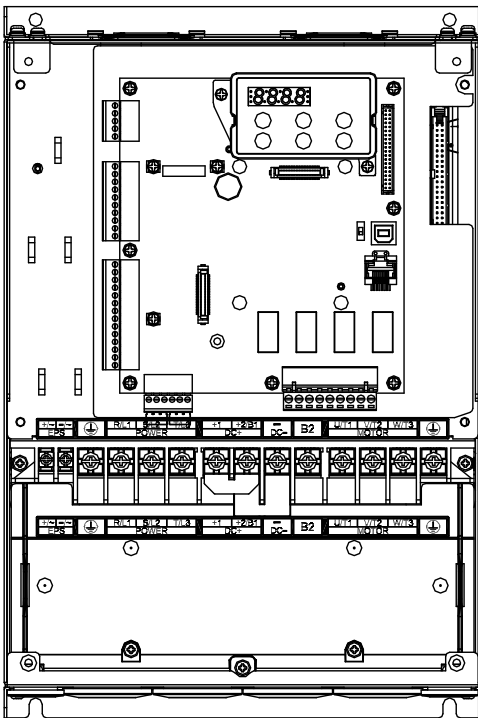

Figure 2

Frame C



Main circuit terminals:

R/L1, S/L2, T/L3, U/T1, V/T2, W/T3, +1, +2/B1, -, B2

Models	Wire Gauge		Screw Size & Torque ($\pm 10\%$)
	Max. Wire Gauge	Min. Wire Gauge	
VFD055ED23S	6AWG [13.3mm ²]	10AWG [3.3mm ²]	M5 30 kgf-cm (26 lbf-in) (2.9 Nm)
VFD110ED43S		12AWG [3.3mm ²]	
VFD055ED43S			
VFD075ED43S			
VFD075ED23S		6AWG [13.3mm ²]	
VFD150ED43S			
VFD185ED43S			
VFD110ED23S			

UL installations must use 600V, 75°C wire. Use copper wire only.

NOTE:

- Figure 1 shows the terminal specification.
- Figure 2 shows the specification of insulated heat shrink tubing that comply with UL (600V, YDPU2).

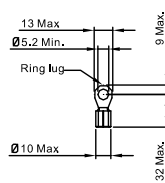

Figure 1

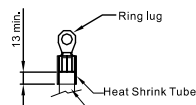
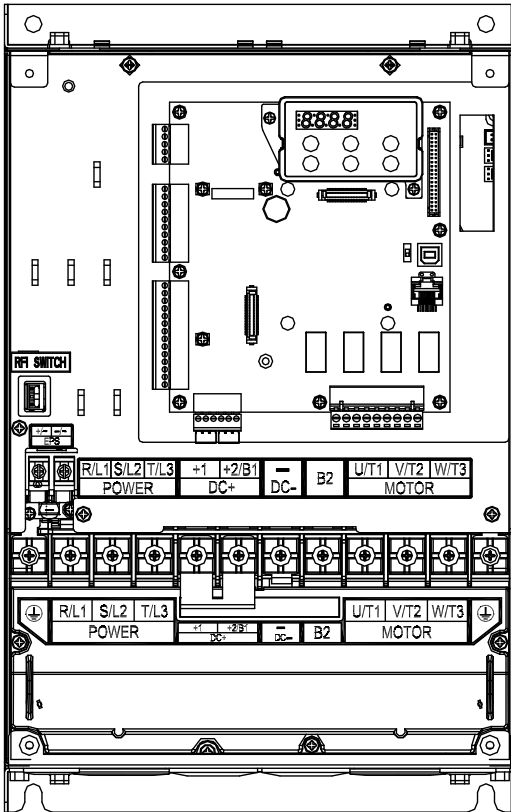

Figure 2

Frame D



Main circuit terminals:

R/L1, S/L2, T/L3, U/T1, V/T2, W/T3, +1, +2/B1, -, B2, ↓

Models	Wire Gauge		Screw Size & Torque (±10%)
	Max. Wire Gauge	Min. Wire Gauge	
VFD150ED23S	2AWG [33.6mm ²]	4AWG [21.1mm ²]	M6 50 kgf-cm (43.4 lbf-in) (4.9 Nm)
VFD300ED43S		3AWG[26.7mm ²]	
VFD185ED23S		6AWG[13.3mm ²]	
VFD220ED43S			
VFD220ED23S		2AWG[33.6mm ²]	

UL installations must use 600V, 75 °C wire. Use copper wire only.

NOTE:

- Figure 1 shows the terminal specification.
- Figure 2 shows the specification of insulated heat shrink tubing that comply with UL (600V, YDPU2).

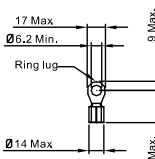

Figure 1

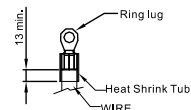
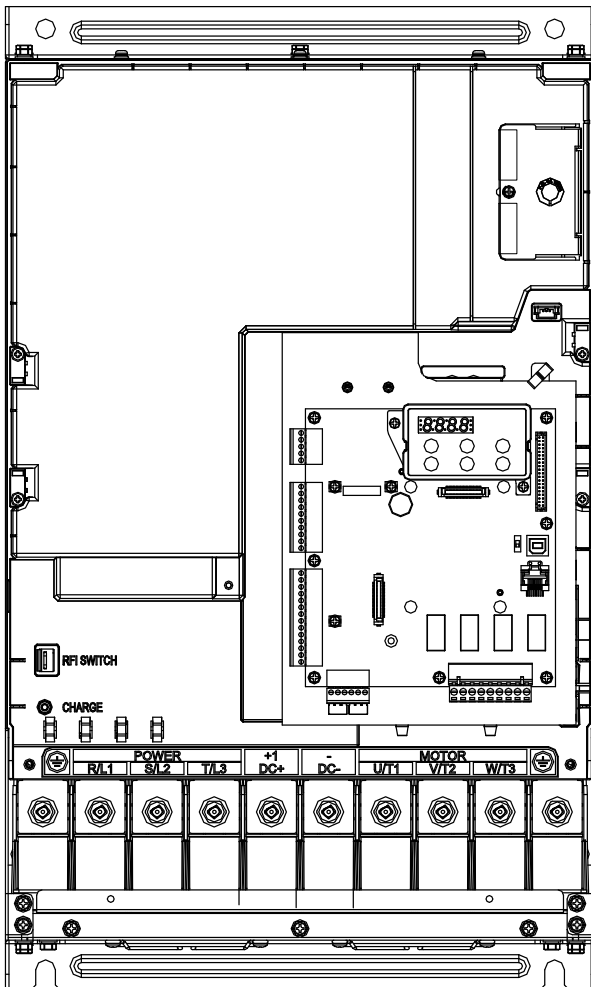

Figure 2

Frame E



Main circuit terminals:

R/L1, S/L2, T/L3, U/T1, V/T2, W/T3, +1(DC+), -(DC-), ↓

Models	Wire Gauge		Screw Size & Torque (±10%)
	Max. Wire Gauge	Min. Wire Gauge	
VFD370ED43S	300MCM [152mm ²]	1/0AWG[53.5mm ²]	M8 200 kgf-cm (173 lbf-in) (19.6 Nm)
VFD450ED43S		2/0AWG[67.4mm ²]	
VFD300ED23S		4/0AWG [107mm ²]	
VFD550ED43S			
VFD370ED23S		300MCM [152mm ²]	

UL installations must use 600V, 75 °C wire. Use copper wire only.

NOTE:

- Figure 1 shows the terminal specification.
- Figure 2 shows the specification of insulated heat shrink tubing that comply with UL (600V, YDPU2).

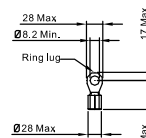

Figure 1

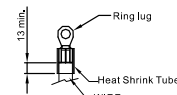

Figure 2

05 Control Terminals

Remove the top cover before wiring the multi-function input and output terminals

The motor drives' figures shown below are for reference only; the actual motor drives may look different.

5-1 Remove the cover before wiring

Frame B, C & D:

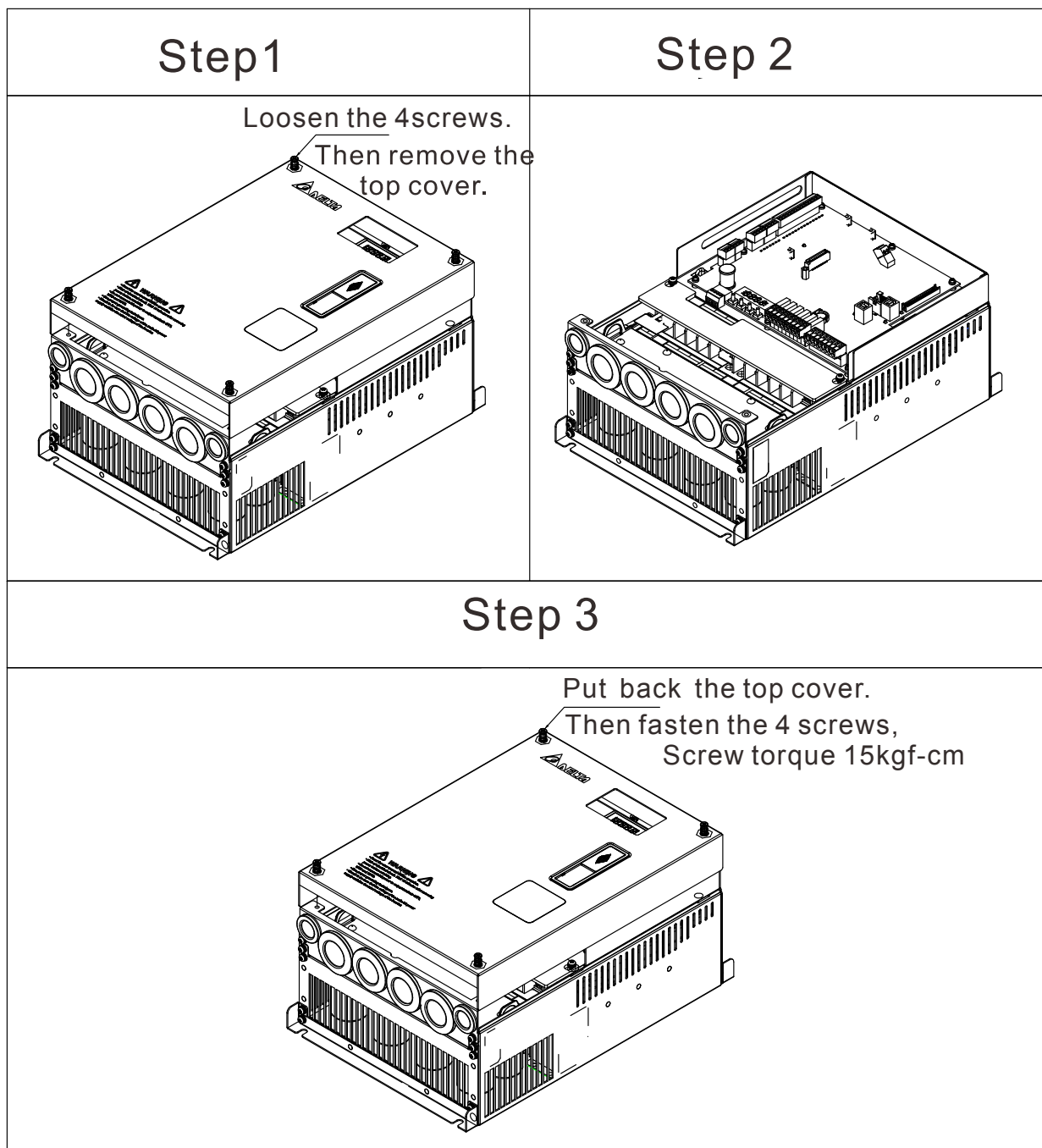

Frame E

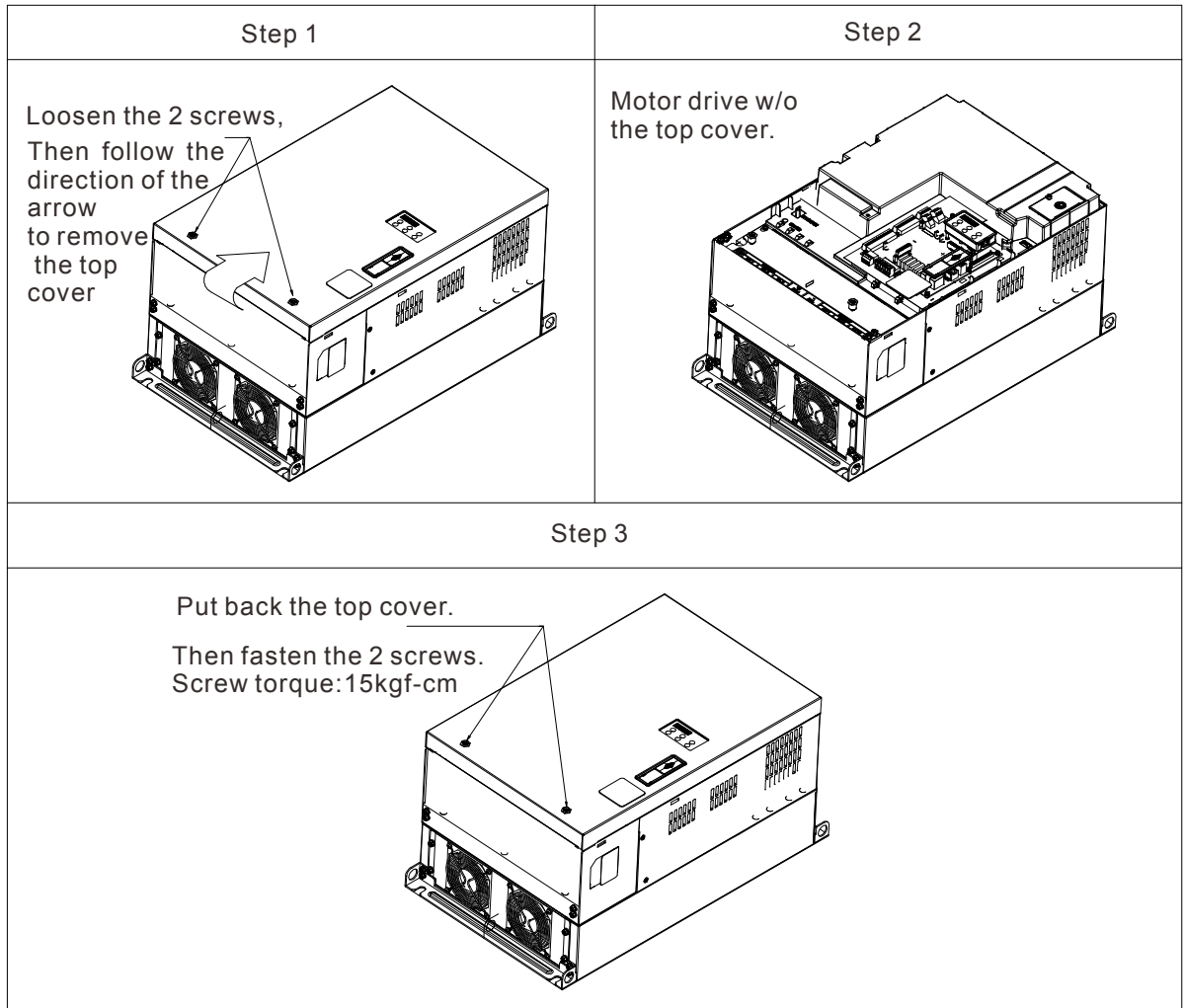

5-2 Specifications of the Control Terminal

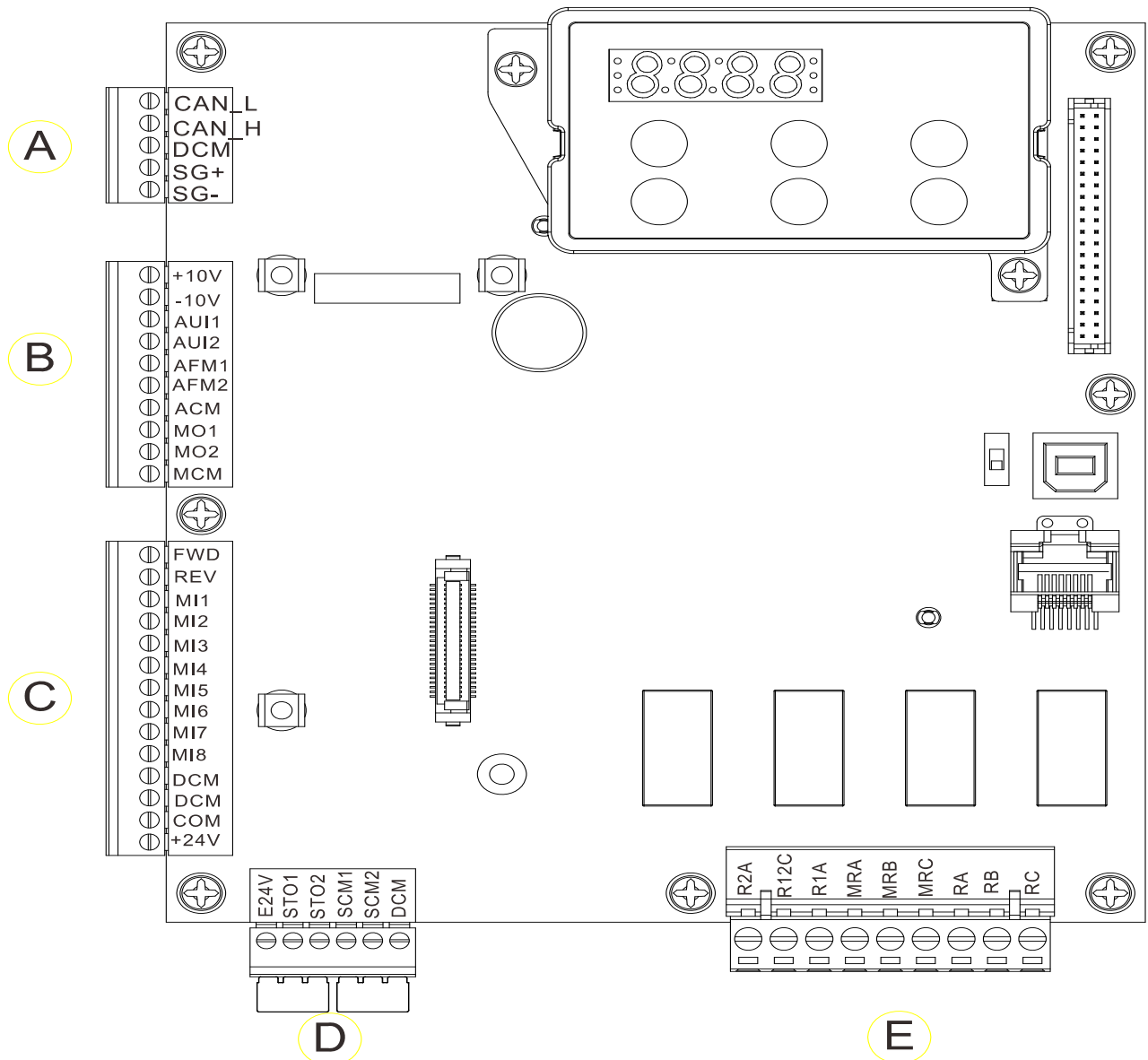

5-3 Control Circuit Terminal Sockets:

Terminal sockets A, B, C

Torque force: 2kg-cm [1.7lb-in.] (0.20Nm)

Wire gauge: 28~14AWG [0.08~2.07mm²]

Terminal socket D:

Torque force: 2kg-cm [1.7lb-in.] (0.20Nm)

Terminal socket E:

Torque force: 5.2kg-cm [4.5lb-in.] (0.51Nm)

Wire gauge: 28~12AWG [0.08~3.33mm²]

To comply with UL standards, copper wires which are able to sustain 600V, 75 °C environments must be used in the installation.

Control Board Switch

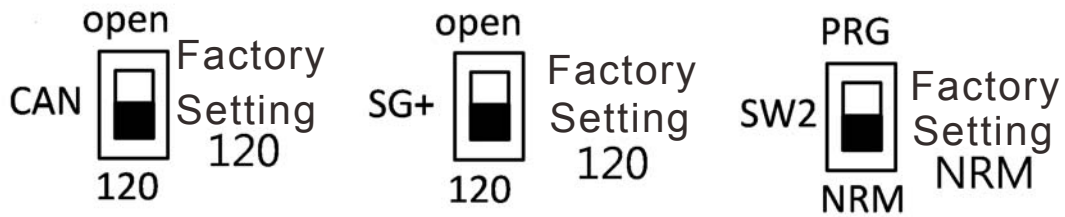

NRM = Normal

Terminals	Terminal Function	Factory Setting (NPN mode)
+24V/E24V	Digital control signal common terminal (Source)	+24V±5% 200mA
COM	Digital control signal common terminal (Sink)	Common terminal of multi-function input terminals
FWD	Forward-Stop command	FWD-DCM: ON= forward running OFF= deceleration to stop
REV	Reverse-Stop command	REV-DCM: ON= forward running OFF= deceleration to stop
MI1 ~ MI8	Multi-function input 1~8	Refer to parameters 02-01~02-08 to program the multi-function inputs MI1~MI8. Source mode: ON: the activation current is 6.5mA ≥ 11Vdc OFF: cut-off voltage 10µA ≤ 11Vdc
DCM	Digital frequency signal common terminal	
SCM1		
SCM2	The factory setting is short-circuiting.	
STO1	The factory setting is short-circuiting.	
STO2	Power removal safety function for EN954-1 and IEC/EN61508	
	When STO1~SCM1, STO2~SCM2 are turned on, the activation current is 3.3mA ≥ 11Vdc.	
+10V	Potentiometer power supply	Power supply of analog frequency setting: +10Vdc 20mA
-10V	Potentiometer power supply	Power supply of analog frequency setting
AUI1	Analog voltage frequency input	Impedance: 20kΩ Range: -10~+10VDC=0~ Max. Output

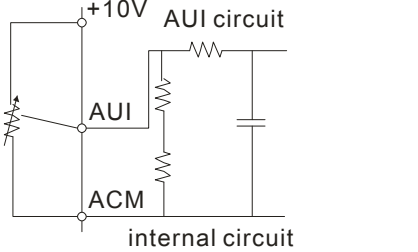
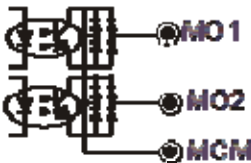
AUI2		Frequency(Pr.01-00)
ACM	Analog signal common terminal control	Analog signal terminal
RA	Multi-function relay output A (N.O.)	<p>1. User-defined function 2. Resistive Load 3A(N.O.)/3A(N.C.) 250VAC 5A(N.O.)/3A(N.C.) 30VDC (min. 5 VDC, 10 mA)</p> <p>To output different kinds of signal such as the motor drive is in operation, reaching the frequency, overload indication.</p>
RB	Multi-function relay output A (N.C.)	
RC	Multi-function relay output B (Error indication by factory setting)	
MRA	Multi-function output terminal (N.O.)	
MRB	Multi-function output terminal (N.C.)	
MRC	Multi-function output terminal (Operating Indication by factory setting)	
R1A	Multi-function output terminal A (N.O.)	
R2A	Multi-function output terminal A (N.O.)	
R12C	Multi-function output terminal (No function by factory setting)	
SG1+	Modbus RS-485	
SG1-	Modbus RS-485	open
CAN_L	CAN Bus	DIP Switch: terminator 120 ohm (factory setting)/ open
CAN_H	CAN Bus	
MO1	Multi-function output terminal 1 (photocoupler)	The AC motor drive releases various monitoring signals, such as drive in operation, reaching frequency and overload indication via a transistor (open collector).
MO2	Multi-function output terminal 2 (photocoupler)	

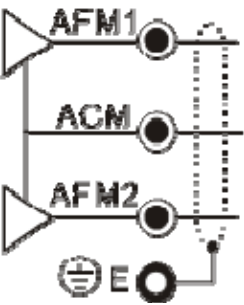
MCM	Multi-function output common terminal (photocoupler)	Max 48Vdc 50mA
AFM1		<p>0~10V, Max. output current: 2mA, Max. load: 5kΩ -10~10V, Max. output current: 2mA, Max. load :5kΩ Output current 2mA max Resolution 0~10V corresponds to the Max. operating frequency. Range: 0~10V→-10~+10V</p>
AFM2		<p>0~10V, Max. Output current: 2mA, Max. load: 5KΩ -10~10V, Max. output current: 2mA, Max. load: 5kΩ Output current: 2mA max Resolution: 0~10V corresponds to the Max. operating frequency. Range: 0~10V→-10~+10V</p>
RJ-45	PIN 1,2,6,7 : Reserved PIN 3: SGND PIN 4: SG- PIN 5: SG+ PIN 8: EV	
SW2	Switching USB port	DIP Switch: NRM (factory setting) / PRG (this side of the switch is to update firmware and is intended for qualified motor drive service personnel only. Do NOT try to update by yourself.

06 Optional Accessories

The optional accessories listed in this chapter are available upon request. Installing additional accessories to your drive would substantially improve the drive's performance. Please select an applicable accessory according to your need or contact the local distributor for suggestion.

6-1 Brake Resistors & Brake Units used in AC motor Drives

Voltage	Applicable Motor	125% Braking Torque /30% ED * ¹							Max. Brake Torque * ²			
	Model	Braking Torque * ³ (kg-m)	Brake Unit		Resistor value spec. for each AC motor Drive	Braking Resistor series for each						Braking Current (A)
			VFDB* ⁵	Quantity		Brake Unit						
						model #* ⁴	Quantity	Wiring Method	Min. Resistor Value(Ω)	Max. Total Braking Current(A)	Peak Power (kW)	
230V	VFD022ED21S	1.5			1000W 75Ω	BR1K0W075	1		5.1	38.0	10	3.8
	VFD037ED21S	2.5			2000W 37.5Ω	BR1K0W075	2	2 parallel	10.1	19.0	20	7.6
	VFD040ED23S	2.5			2000W 37.5Ω	BR1K0W075	2	2 parallel	10.1	19.0	20	7.6
	VFD055ED23S	3.7			3000W 25Ω	BR1K0W075	3	3 parallel	15.2	15.6	24.4	9.3
	VFD075ED23S	5.1			3000W 25Ω	BR1K0W075	3	3 parallel	15.2	11.5	33	12.5
	VFD110ED23S	7.5			5000W 15Ω	BR1K0W075	5	5 parallel	25.3	9.5	40	15.2
	VFD150ED23S	10.2			6000W 13Ω	BR1K5W013	4	2 serial 2 parallel	29.2	8.3	46	17.5
	VFD185ED23S	12.2			8000W 9.4Ω	BR1K0W075	8	8 parallel	38.0	5.8	66	25.1
	VFD220ED23S	14.9			8000W 9.4Ω	BR1K0W075	8	8 parallel	40.5	5.8	66	25.1
	VFD300ED23S	20.3	2015	2	9000W 6.5Ω	BR1K5W013	8	2 serial 4 parallel	58.5	4.8	80	30.4
	VFD370ED23S	25.1	2022	2	14000W 5.4Ω	BR1K0W075	14	14 parallel	70.9	3.2	120	45.6
460V	VFD040ED43S	2.7			1500W 280Ω	BR750W140	2	2 serial	2.7	54.3	14	10.6
	VFD055ED43S	3.7			2000W 150Ω	BR1K0W075	2	2 serial	5.1	48.4	15.7	11.9
	VFD075ED43S	5.1			4000W 75Ω	BR1K0W075	4	2 serial 2 parallel	10.1	48.4	15.7	11.9
	VFD110ED43S	7.5			4000W 75Ω	BR1K0W075	4	2 serial 2 parallel	10.1	30.8	24.7	18.8
	VFD150ED43S	10.1			6000W 50Ω	BR1K0W075	6	2serial 3 parallel	15.2	25.0	30.4	23.1
	VFD185ED43S	12.5			8000W 37.5Ω	BR1K0W075	8	2 serial 4 parallel	20.3	20.8	36.5	27.7
	VFD220ED43S	14.9			8000W 37.5Ω	BR1K0W075	8	2 serial 4 parallel	20.3	19.0	40	30.4
	VFD300ED43S	20.3			12000W 26Ω	BR1K5W043	8	4 serial 2 parallel	29.2	14.1	54	41.0
	VFD370ED43S	25.0	4045	1	14000W 21.4Ω	BR1K1W024	14	2 serial 7 parallel	35.5	12.7	60	45.6

VFD450ED43S	30.4	4045	1	16000W 18.8Ω	BR1K0W016	16	2 serial 8 parallel	40.5	12.7	60	45.6
VFD550ED43S	37.2	4030	2	20000W 15Ω	BR1K0W016	20	2 serial 10 parallel	50.7	9.5	80	60.8
VFD750ED43S	50.7	4045	2	28000W 10.7Ω	BR1K0W016	28	2serial 14 parallel	70.9	6.3	120	91.2

*1 Calculation of 125% brake torque: $(kW) \times 125\% \times 0.8$; where 0.8 is the motor efficiency.

Since there is a resistor limit of power consumption, the longest operation time for 30%ED is 30 sec (On: 30sec/ Off: 70sec).

*2 Refer to the Brake Performance Curve for “Operation Duration & ED” vs. “Braking Current”.

*3 The calculation of the braking torque I s based on a 4-pole motor (1800 rpm).

*4 To dissipate heat, a resistor of 400W or lower should be fixed to the frame and maintain the surface temperature below 250°C (482 °F); a resistor of 1000W and above should maintain the surface temperature below 600°C (1112 °F). If the surface temperature is higher than the temperature limit, install more heat dissipating system or increase the size of the resistor.

*5 Refer to VFDB series Braking Module Instruction for more detail on braking resistor.

NOTE

1. Select the recommended resistance value (Watt) and the duty-cycle value (ED %).

Definition for Brake Usage ED%

Explanation: The definition of the brake usage ED (%) is for assurance of enough time for the brake unit and brake resistor to dissipate away heat generated by braking. When the brake resistor heats up, the resistance would increase with temperature, and brake torque would decrease accordingly. Recommended cycle time is one minute.

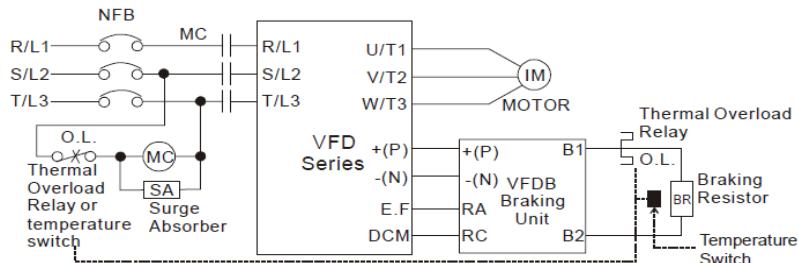
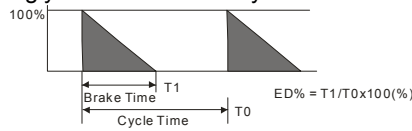

Note1: When using the AC drive with DC reactor, please refer to wiring diagram in the AC drive user manual for the wiring of terminal + (P) of Braking unit.
 Note2: Do NOT wire terminal - (N) to the neutral point of power system.

For safety consideration, install an overload relay between the brake unit and the brake resistor. In conjunction with the magnetic contactor (MC) prior to the drive, it can perform complete protection against abnormality. The purpose of installing the thermal overload relay is to protect the brake resistor from damage due to frequent brake, or due to brake unit keeping operating resulted from unusual high input voltage. Under such circumstance, just turn off the power to prevent damaging the brake resistor.

2. If damage to the drive or other equipment is due to the fact that the brake resistors and the brake modules in use are not provided by Delta, the warranty will be void.
3. Take into consideration the safety of the environment when installing the brake resistors. If the minimum resistance value is to be utilized, consult local dealers for the calculation of the Watt figures.
4. When using more than 2 brake units, equivalent resistor value of parallel brake unit can't be less than the value in the column “Minimum Equivalent Resistor Value for Each AC Drive” (the right-most column in the table).
5. This chart is for normal usage; if the AC motor drive is applied for frequent braking, it is suggested to enlarge 2~3 times of the Watts.
6. Thermal relay selection:

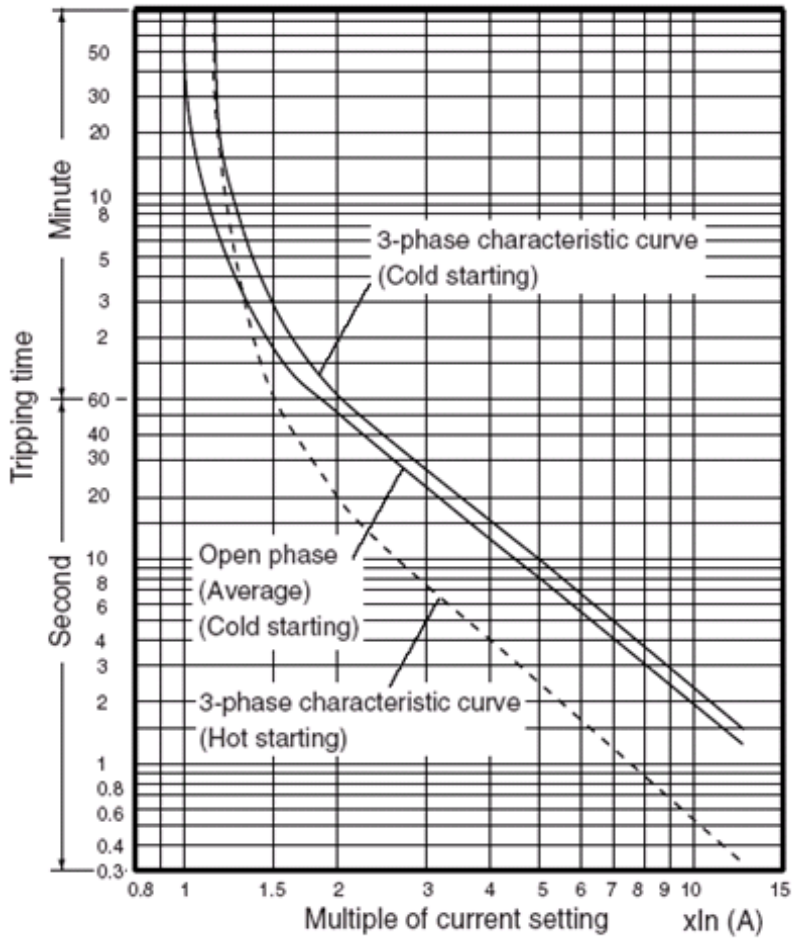

Thermal Relay:

Thermal relay selection is based on its overload capability. A standard braking capacity of ED is 10%ED (Tripping time=10s). The figure on the left is an example of 460V, 110kw AC motor drive. It requires the thermal relay to take 260% overload capacity for 10sec (hot starting) and the braking current is 126A. In this case, user should select a rated 50A thermal relay. The property of each thermal relay may vary among different manufacturers. Read carefully the user guide of a thermal relay before using it. .

6-2 Non-fuse Circuit Breaker

Comply with UL standard: Per UL 508, paragraph 45.8.4, part a. The rated current of a breaker shall be 2~4 times of the maximum rated input current of AC motor drive.

3-phase		3-phase	
Model	Recommended non-fuse breaker(A)	Model	Recommended non-fuse breaker(A)
VFD022ED21S	50	VFD040ED43S	30
VFD037ED21S	75	VFD055ED43S	35
VFD040ED23S	40	VFD075ED43S	40
VFD055ED23S	50	VFD110ED43S	50
VFD075ED23S	60	VFD150ED43S	60
VFD110ED23S	100	VFD185ED43S	75
VFD150ED23S	125	VFD220ED43S	100
VFD185ED23S	150	VFD300ED43S	125
VFD220ED23S	175	VFD370ED43S	150
VFD300ED23S	250	VFD450ED43S	200
VFD370ED23S	300	VFD550ED43S	250
		VFD750ED43S	350

6-3 Fuse Specification Chart

- Use only the fuses comply with UL certificated.
- Use only the fuses comply with local regulations.

Model	Input Current (A)	Line Fuse	
		I (A)	Bussmann P/N
VFD022ED21S	26	60	JJN-60
VFD037ED21S	37	90	JJN-90
VFD040ED23S	20	50	JJN-50
VFD055ED23S	23	60	JJN-60
VFD075ED23S	30	80	JJN-80
VFD110ED23S	47	125	JJN-125
VFD150ED23S	56	150	JJN-150
VFD185ED23S	73	175	JJN-175
VFD220ED23S	90	225	JJN-225
VFD300ED23S	132	300	JJN-300
VFD370ED23S	161	400	JJN-400
VFD040ED43S	11.5	35	JJS-35
VFD055ED43S	14	40	JJS-40
VFD075ED43S	17	45	JJS-45
VFD110ED43S	24	60	JJS-60
VFD150ED43S	30	80	JJS-80
VFD185ED43S	37	90	JJS-90
VFD220ED43S	47	110	JJS-110
VFD300ED43S	58	150	JJS-150
VFD370ED43S	80	200	JJS-200
VFD450ED43S	100	250	JJS-250
VFD550ED43S	128	300	JJS-300
VFD750ED43S	165	400	JJS-400

6-4 AC/ DC Reactor

AC Input/ Output Reactor

200V~230V/ 50~60Hz (Single Phase Power)

Type	KW	HP	Rated Amps (Arms)	Max. Continuous Amps (Arms)	3% impedance (mH)	5% impedance (mH)	Built-in DC Reactor	3% Input AC reactor Delta Part#
022	2.2	3	12	24	0.919	1.531	X	N/A
037	3.7	5	17	34	0.649	1.081	X	N/A

200V~230V/ 50~60Hz (Three-phase power)

Type	KW	HP	Rated Amps (Arms)	Max. Continuous Amps (Arms)	3% impedance (mH)	5% impedance (mH)	Built-in DC Reactor	3% Input AC reactor Delta Part#
040	4	5	20	40	0.551	0.919	X	N/A
055	5.5	7.5	24	48	0.459	0.766	X	N/A
075	7.5	10	30	60	0.320	0.534	X	N/A
110	11	15	45	90	0.216	0.359	X	N/A
150	15	20	58	116	0.163	0.271	X	N/A
185	18.5	25	77	154	0.143	0.239	X	N/A
220	22	30	87	174	0.127	0.211	X	N/A
300	30	40	132	264	0.084	0.139	O	N/A
370	37	50	161	322	0.068	0.114	O	N/A

380V~460V/ 50~60Hz (Three-phase power)

Type	KW	HP	Rated Amps (Arms)	Max. Continuous Amps (Arms)	3% impedance (mH)	5% impedance (mH)	Built-in DC Reactor	3% Input AC reactor Delta Part#
040	4	5	11.5	23	1.838	3.063	X	N/A
055	5.5	7.5	13	26	1.626	2.710	X	N/A
075	7.5	10	17	34	1.243	2.072	X	N/A
110	11	15	23	46	0.919	1.531	X	N/A
150	15	20	30	60	0.704	1.174	X	N/A
185	18.5	25	38	76	0.556	0.927	X	N/A
220	22	30	45	90	0.470	0.783	X	N/A
300	30	40	58	116	0.364	0.607	X	N/A
370	37	50	80	160	0.264	0.440	O	N/A
450	45	60	100	200	0.211	0.352	O	N/A
550	55	75	128	256	0.165	0.275	O	N/A
750	75	100	165	330	0.128	0.213	O	N/A

DC Input Reactor

200V~230V/ 50~60Hz (Three-phase power)

Type	KW	HP	Rated Amps (Arms)	Max. Continuous Amps (Arms)	DC Reactor (mH)	DC Reactor Delta Part#
040	4	5	20	40	1.273	N/A
055	5.5	7.5	24	48	1.061	N/A
075	7.5	10	30	60	0.740	N/A
110	11	15	45	90	0.498	N/A
150	15	20	58	116	0.375	N/A
185	18.5	25	77	154	0.331	N/A
220	22	30	87	174	0.293	N/A
300	30	40	132	264	0.193	N/A
370	37	50	161	322	0.158	N/A

380V~460V/ 50~60Hz (Three-phase power)

Type	KW	HP	Rated Amps (Arms)	Max. Continuous Amps (Arms)	DC Reactor (mH)	DC Reactor Delta Part#
040	4	5	11.5	23	4.244	N/A
055	5.5	7.5	13	26	3.754	N/A
075	7.5	10	17	34	2.871	N/A
110	11	15	23	46	2.122	N/A
150	15	20	30	60	1.627	N/A
185	18.5	25	38	76	1.284	N/A
220	22	30	45	90	1.085	N/A
300	30	40	58	116	0.842	N/A
370	37	50	80	160	built-in	N/A
450	45	60	100	200	built-in	N/A
550	55	75	128	256	built-in	N/A
750	75	100	165	330	built-in	N/A

THD (Total Harmonic Distortion)

Motor Drive Spec.	Without Built-In Reactor				With Built-in DC Reactor
Reactor Spec.	3% Input AC Reactor	DC Reactor	DC Reactor + 3% Input Reactor	DC + 5% Input Reactor	3% Input Reactor
THD	44%	46%	34%	30%	34%
Note:	THD may vary due to different installation conditions and environment (wires, motors).				

According to IEC61000-3-12, DC Reactor is designed with 4% system impedance, and AC Reactor is designed with 3% system impedance.

6-5 Zero Phase Reactor

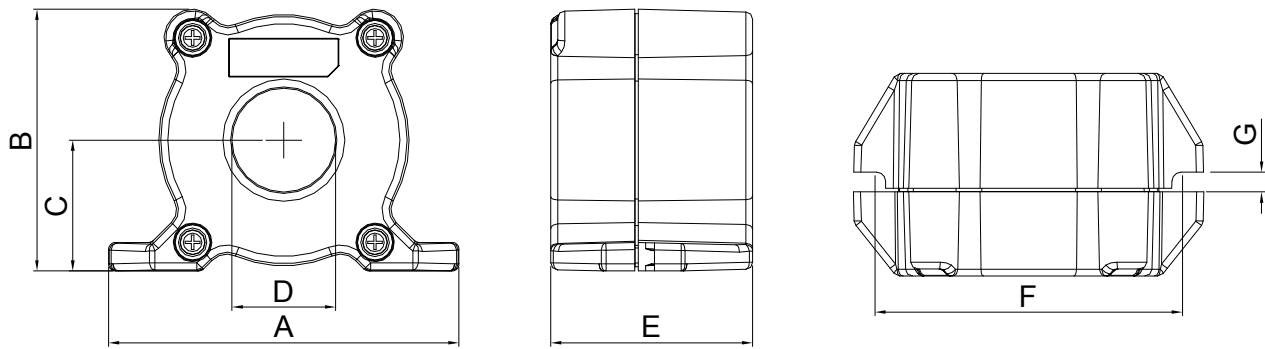

unit: mm (inch)

Model	A	B	C	D	E	F	G(Ø)	Torque
RF008X00A	98 (3.858)	73 (2.874)	36.5 (1.437)	29 (1.142)	56.5 (2.224)	86 (3.386)	5.5 (0.217)	8~ 10kgf/cm
RF004X00A	110 (4.331)	87.5 (3.445)	43.5 (1.713)	36 (1.417)	53 (2.087)	96 (3.780)	5.5 (0.217)	8~ 10kgf/cm

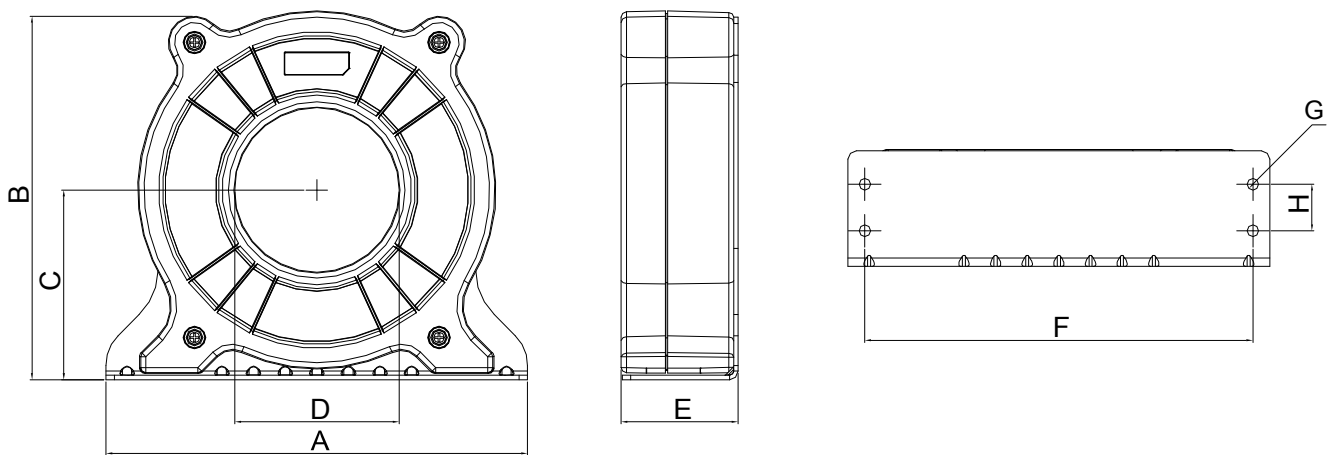

unit: mm (inch)

model	A	B	C	D	E	F	G(Ø)	H	Torque
RF002X00A	200 (7.874)	172.5 (6.791)	90 (3.543)	78 (3.071)	55.5 (2.185)	184 (7.244)	5.5 (0.217)	22 (0.866)	40~45kgf/cm

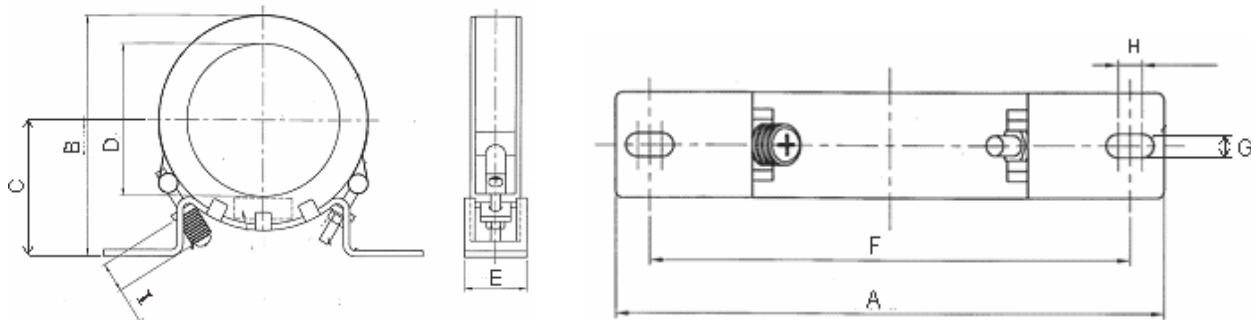

unit: mm (inch)

model	A	B	C	D	E	F	G(Ø)	H	I	Torque
RF300X00A	241(9.488)	217(8.543)	114(4.488)	155(6.102)	42(1.654)	220(8.661)	6.5(0.256)	7.0(0.276)	20(0.787)	40~45kgf/cm

Reactor model (Note)	Recommended Wire Size		Wiring Method	Qty	Applicable Motor Drive
RF008X00A	≤ 8 AWG	≤ 8.37 mm ²	Diagram A	1	VFD022ED21S VFD037ED21S VFD040ED23S VFD040ED43S
RF004X00A	≤ 4 AWG	≤ 21.15 mm ²	Diagram A	1	VFD055ED23S VFD075ED23S VFD110ED23S VFD055ED43S VFD075ED43S VFD110ED43S VFD150ED43S VFD185ED43S
RF002X00A	≤ 2 AWG	≤ 33.62 mm ²	Diagram A	1	VFD150ED23S VFD185ED23S VFD220ED23S VFD220ED43S VFD300ED43S
RF300X00A	≤ 300 MCM	≤ 152 mm ²	Diagram A	1	VFD300ED23S VFD370ED23S VFD370ED43S VFD450ED43S VFD550ED43S VFD750ED43S

Note: 600V insulated cable wire

Diagram A

Put all wires through at least one core without winding

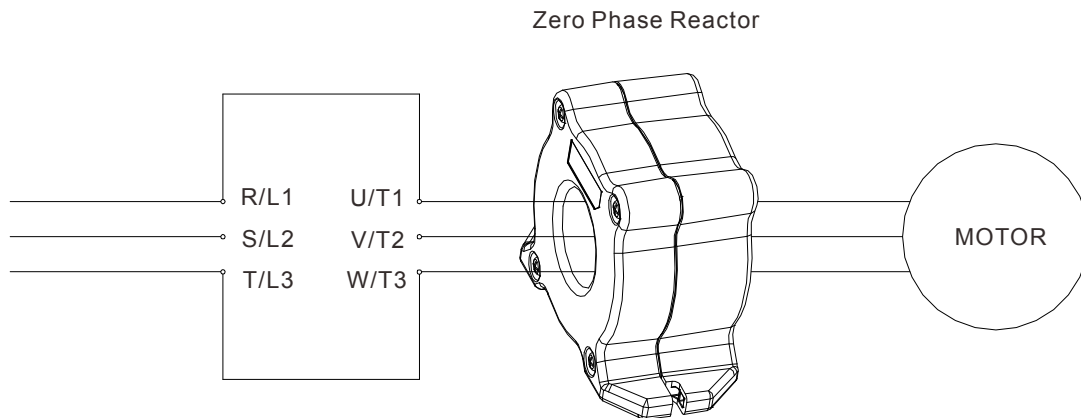

Note 1: The table above gives approximate wire size for the zero phase reactors but the selection is ultimately governed by the type and diameter of cable fitted i.e. the cable must fit through the center hole of zero phase reactors.

Note 2: Only the phase conductors should pass through, not the earth core or screen.

Note3: When long motor output cables are used an output zero phase reactor may be required to reduce radiated emissions from the cable.

6-6 EMI Filter

The following table shows external EMC filter models for each ED-S series motor drive.

Choose corresponding zero phase reactor and applicable shielding cable according to required noise emission and electromagnetic disturbance rating, to make the best assembly and restrain electromagnetic disturbance. If radiation emission (RE) is ignored, and only needs conducted emission (CE) to reach EN55011 Class A on site, zero phase reactor does not need to add at input side, and it can reach the standard of EMC.

220V models

VFD-ED			EMI Filter Model #	Zero Phase Inverter		Carrier Frequency	EN12015	
Frame	Motor Drive model #	Rated Input Current (A)		Input side (R/S/T)	Output side (U/V/W)		Conducted Emission	Radiation Emission
							Length of output shielded cable 50m	
B	VFD022ED21S	24	B84142A0042R122	RF008X00A	-	Carrier frequency by factory setting	CLASS A	CLASS A
	VFD037ED21S	34	B84142A0042R122	RF008X00A	-		CLASS A	CLASS A
	VFD040ED23S	20	EMF035A23A	RF008X00A	-		CLASS A	CLASS A
C	VFD055ED23S	23	EMF056A23A	RF004X00A	-		CLASS A	CLASS A
	VFD075ED23S	30	EMF056A23A	RF004X00A	-		CLASS A	CLASS A
	VFD110ED23S	47	EMF056A23A	RF004X00A	-		CLASS A	CLASS A
D	VFD150ED23S	56	B84143D0150R127	RF002X00A	-		CLASS A	CLASS A
	VFD185ED23S	73	B84143D0150R127	RF002X00A	-		CLASS A	CLASS A
	VFD220ED23S	90	B84143D0150R127	RF002X00A	-		CLASS A	CLASS A
E	VFD300ED23S	132	B84143D0150R127	RF002X00A	-		CLASS A	CLASS A
	VFD370ED23S	161	B84143D0200R127	RF300X00A	-	CLASS A	CLASS A	

460V models

VFD-ED			EMI Filter model #	Zero Phase Reactor		Carrier Frequency	EN12015	
Frame	Motor Drive model #	Rated Input Current (A)		Input Side (R/S/T)	Output Side (U/V/W)		Conducted Emission	Radiation Emission
							Length of output Shielded Cable 50m	
B	VFD040ED43S	11.5	EMF018A43A	RF008X00A	-	Carrier Frequency by Factory Setting	CLASS A	CLASS A
C	VFD055ED43S	14	EMF033A43A	RF004X00A	-		CLASS A	CLASS A
	VFD075ED43S	17	EMF033A43A	RF004X00A	-		CLASS A	CLASS A
	VFD110ED43S	24	EMF033A43A	RF004X00A	-		CLASS A	CLASS A
	VFD150ED43S	30	B84143D0075R127	RF004X00A	-		CLASS A	CLASS A
	VFD185ED43S	37	B84143D0075R127	RF004X00A	-		CLASS A	CLASS A
D	VFD220ED43S	47	B84143D0090R127	RF002X00A	-		CLASS A	CLASS A
	VFD300ED43S	58	B84143D0090R127	RF002X00A	-		CLASS A	CLASS A
E	VFD370ED43S	80	B84143D0200R127	RF300X00A	-		CLASS A	CLASS A
	VFD450ED43S	100	B84143D0200R127	RF300X00A	-		CLASS A	CLASS A
	VFD550ED43S	128	B84143D0200R127	RF300X00A	-		CLASS A	CLASS A
	VFD750ED43S	165	B84143D0200R127	RF300X00A	-		CLASS A	CLASS A

EMI Filter Schematic Diagrams

EMI Filter model #: EMF018A43A

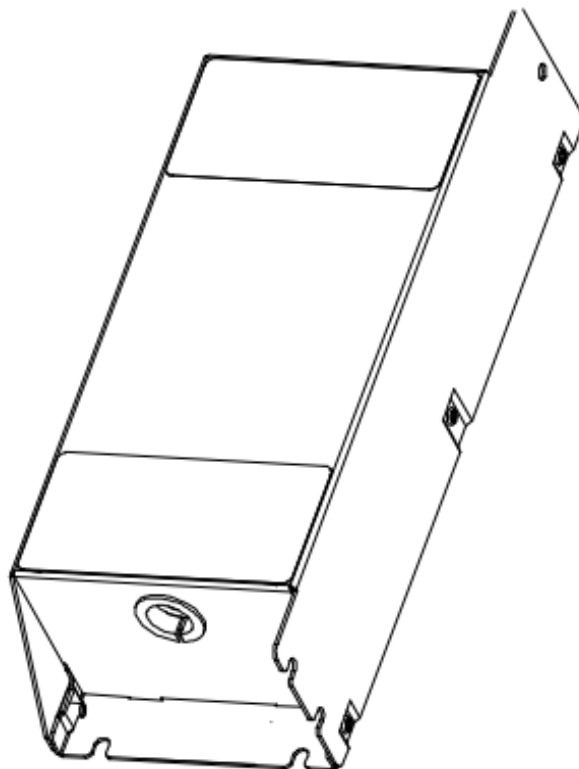
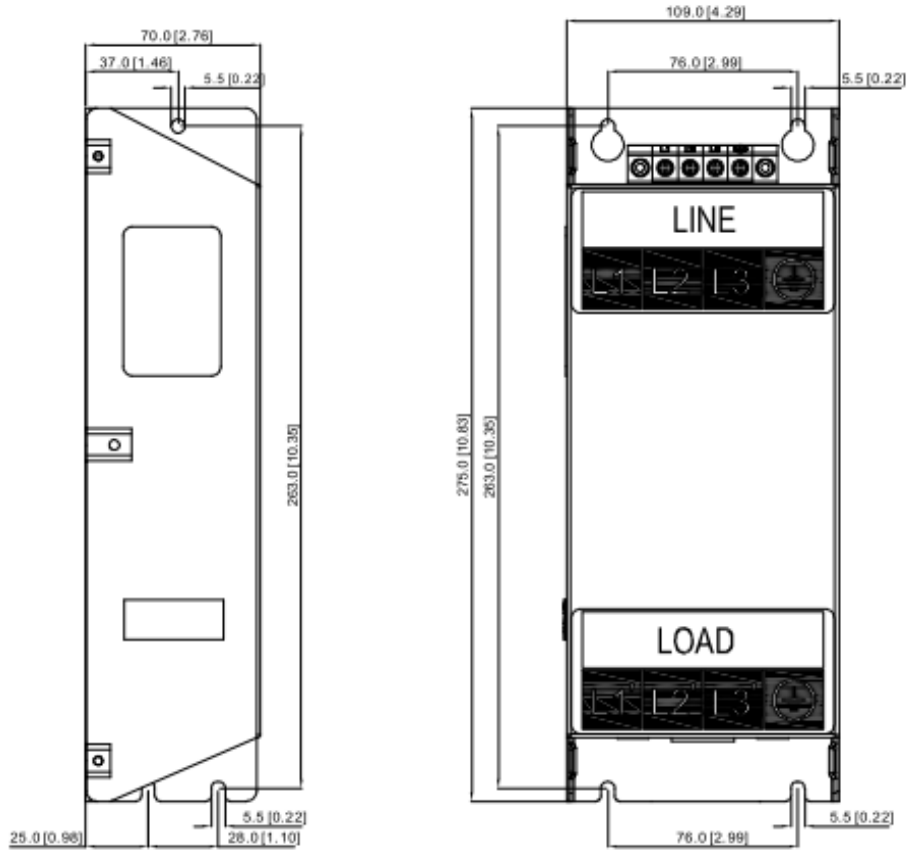

EMI Filter model #: EMF035A23A、EMF033A43A

7

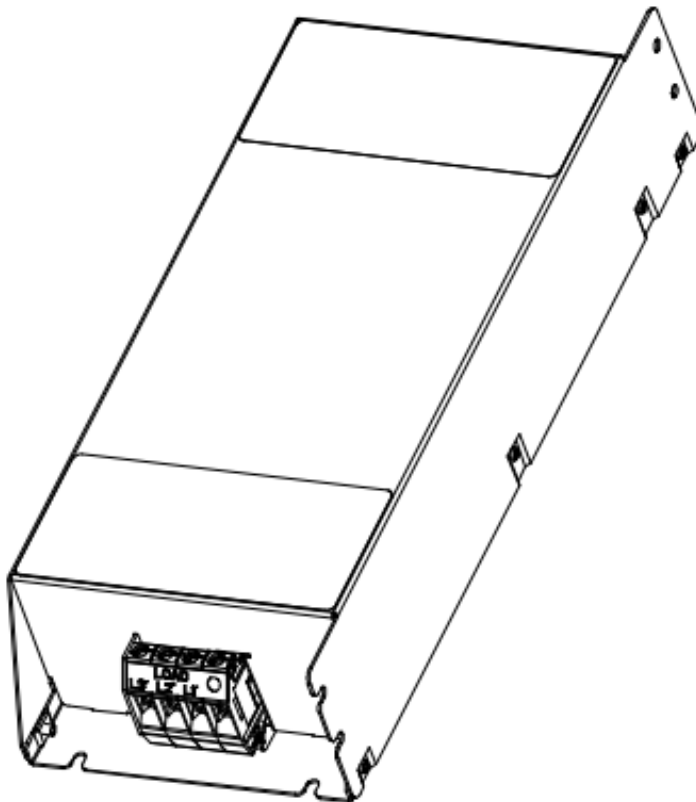
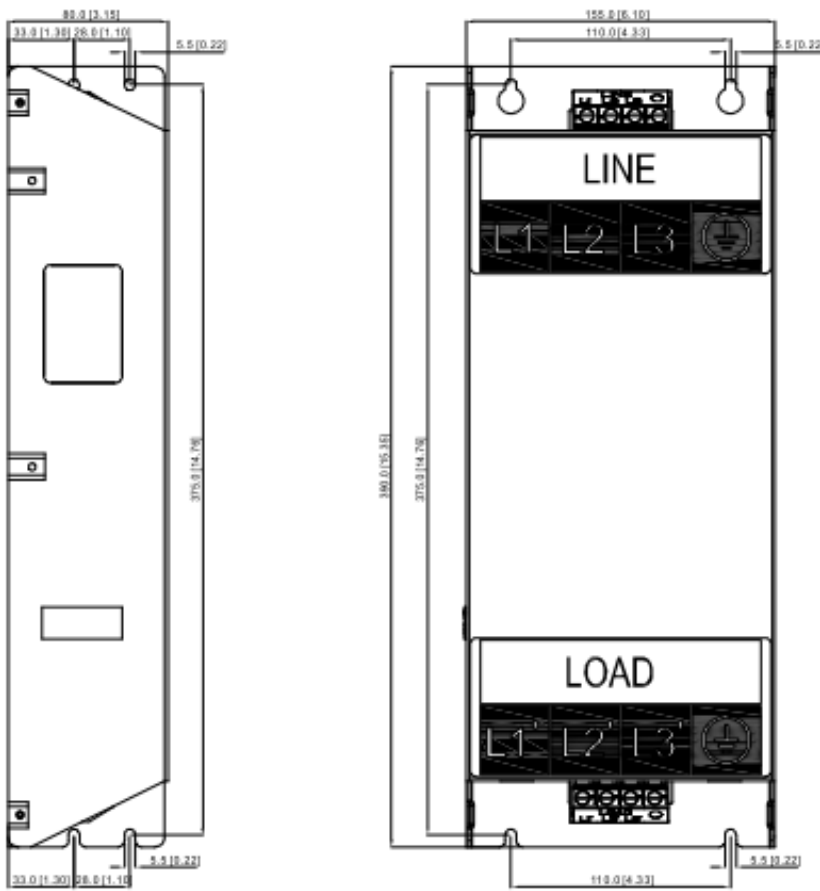

EMI Filter model #: EMF056A23A

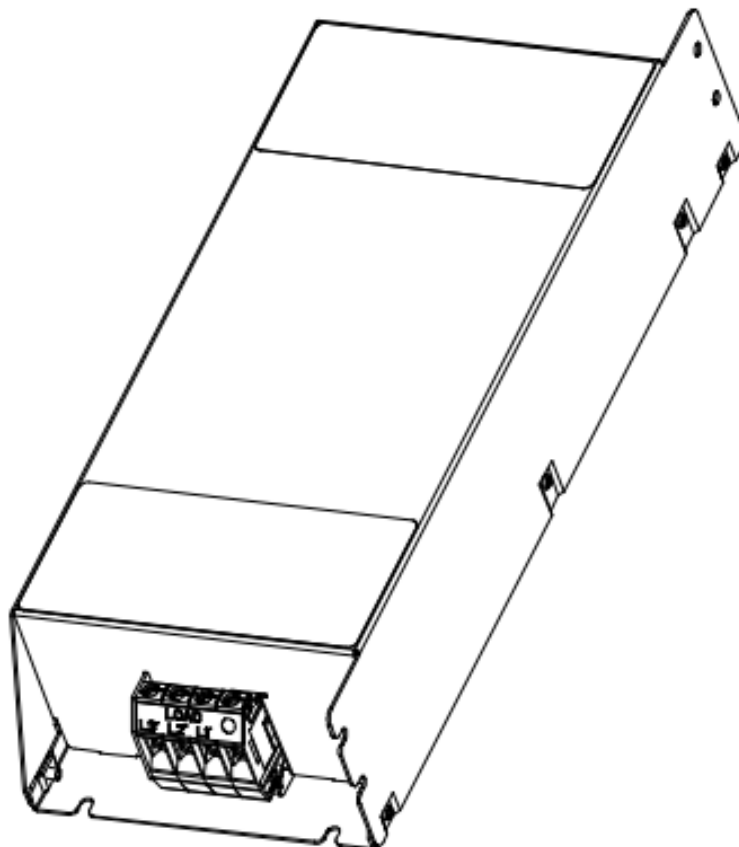
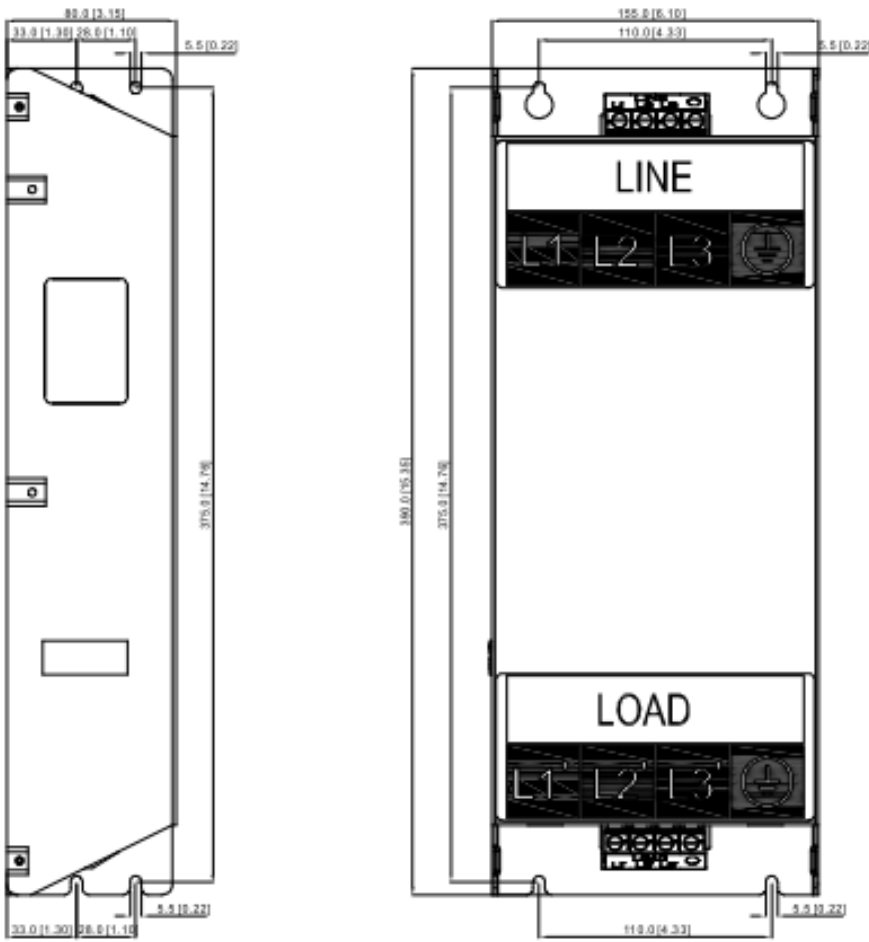

EMI Filter model #: B84143D0075R127; B84143D0090R127

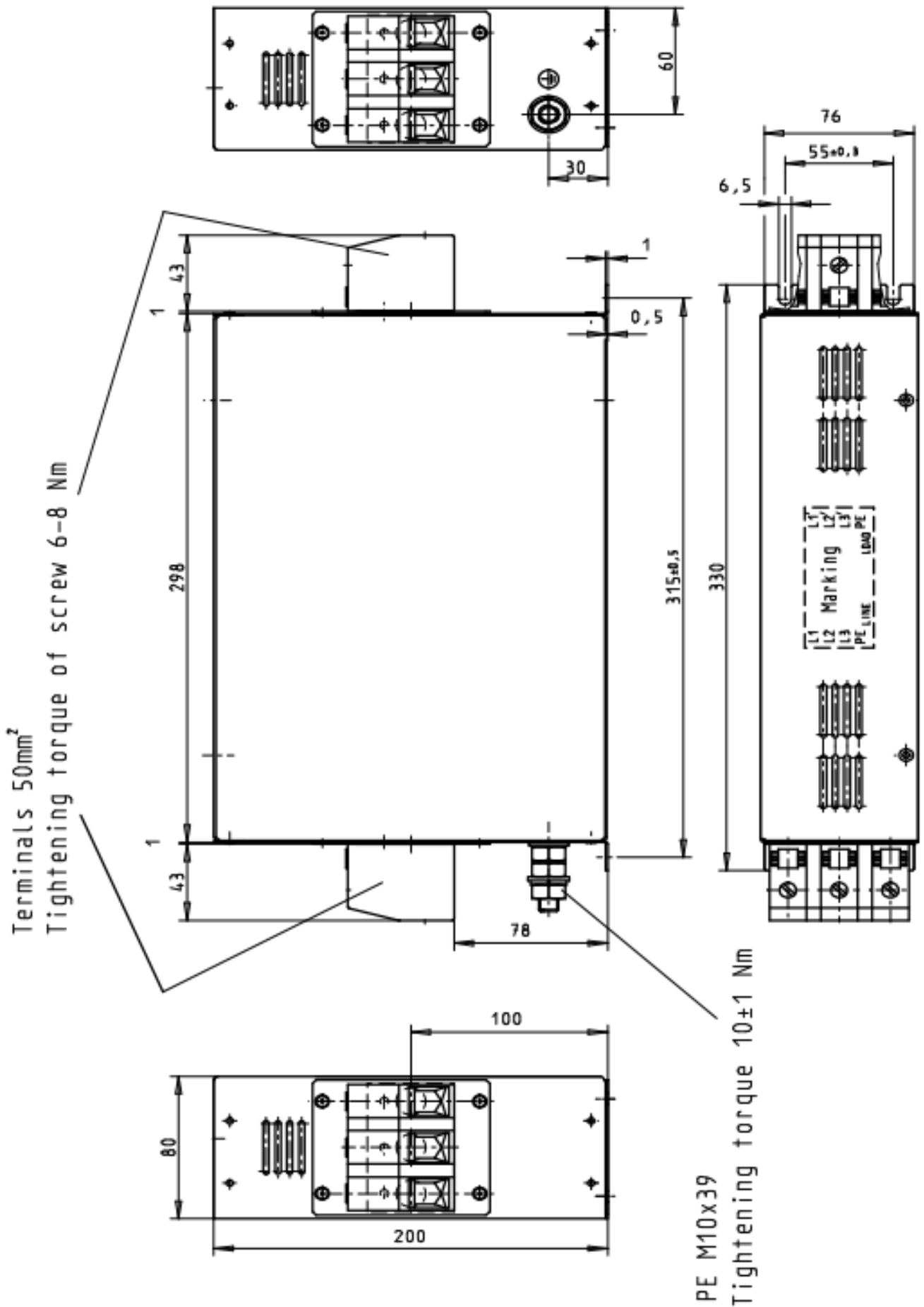

EMI Filter model #: B84143D0150R127

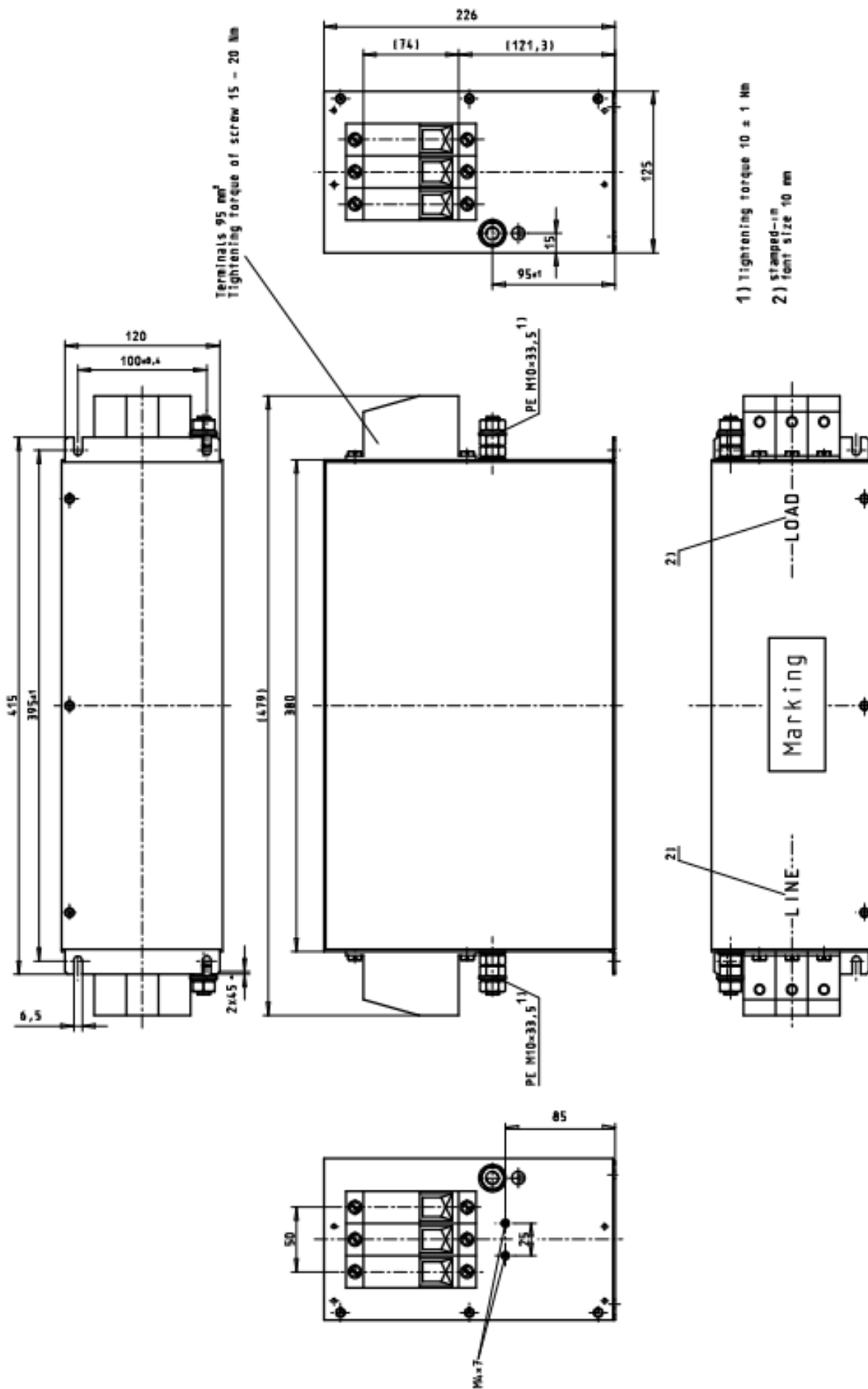

EMI Filter model #: B84143D0200R127

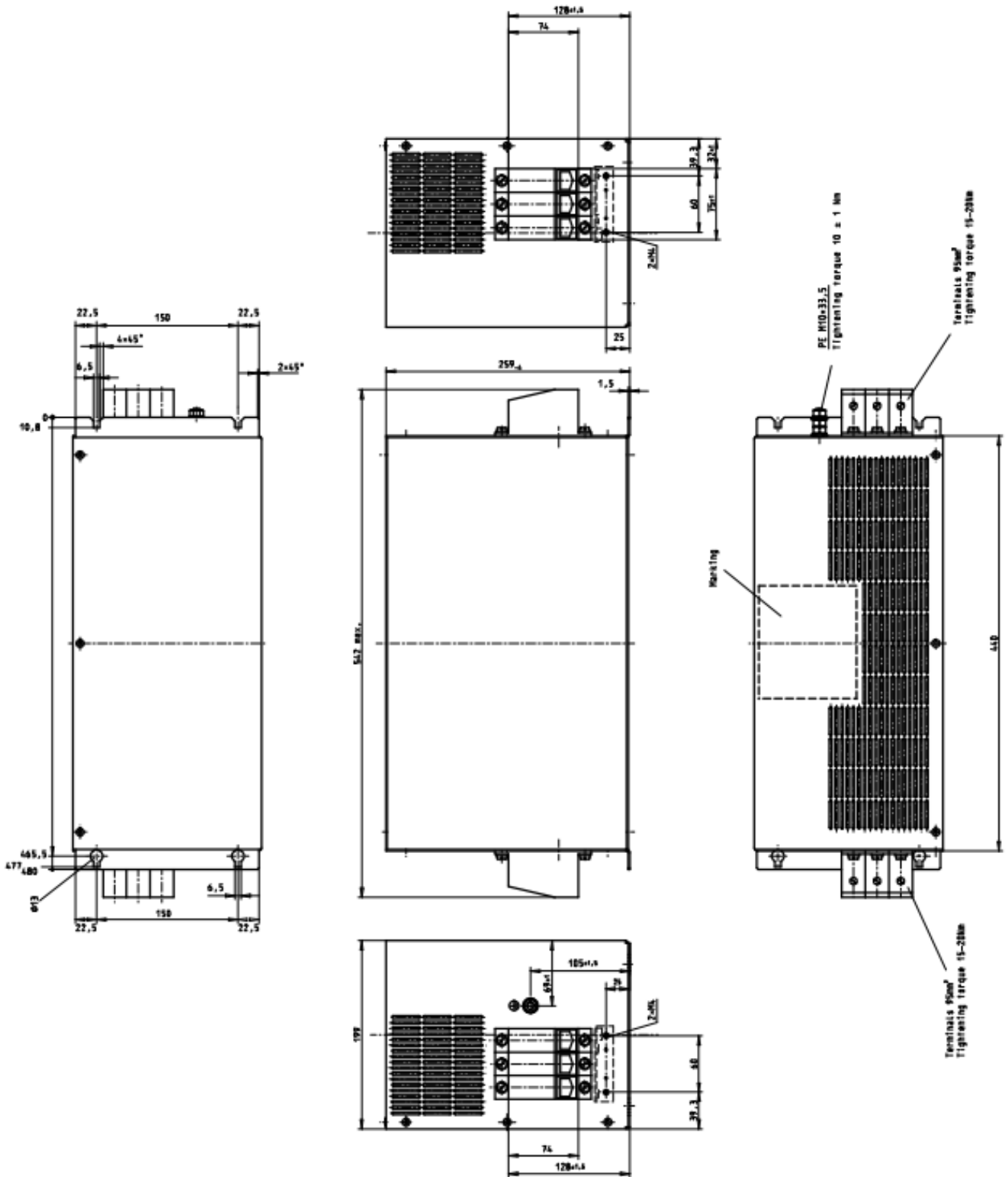

EMI Filter model #: B84142A0042R122

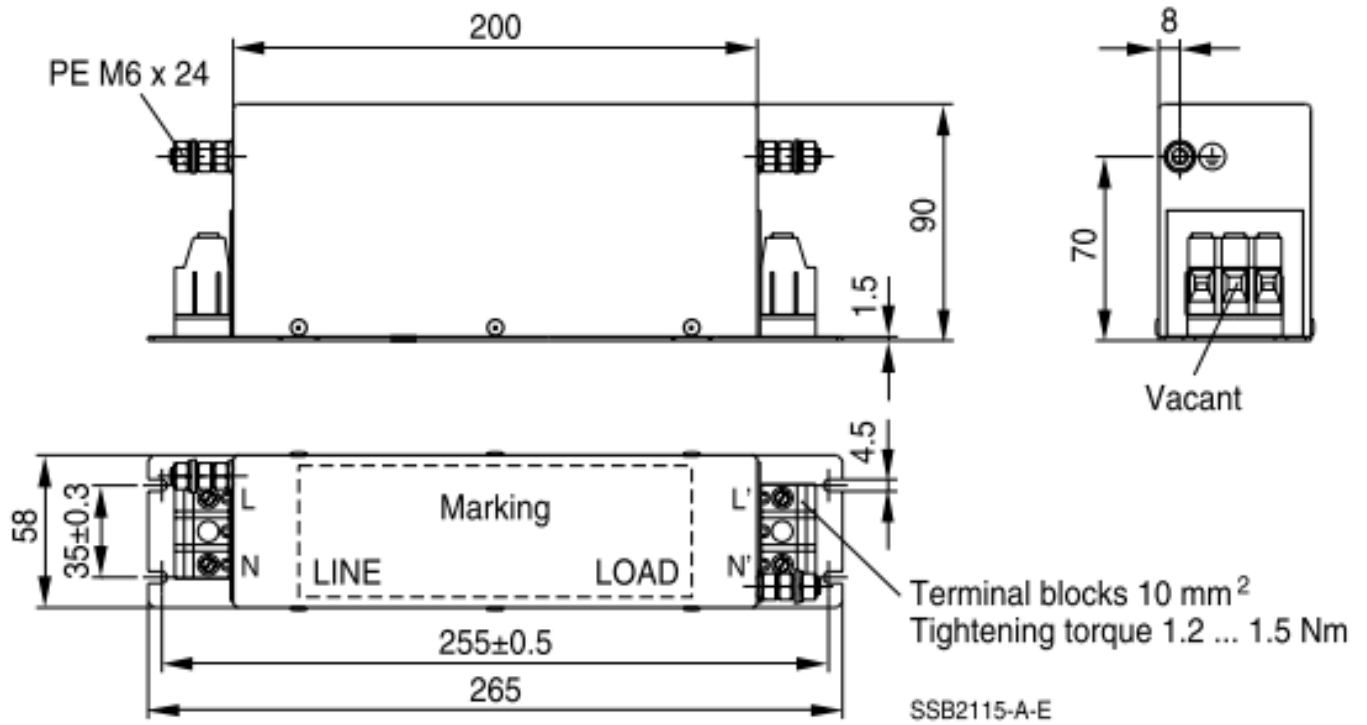

EMI Filter Installation

All electrical equipment, including AC motor drives, will generate high-frequency/low-frequency noise and will interfere with peripheral equipment by radiation or conduction when in operation. By using an EMI filter with correct installation, much interference can be eliminated. It is recommended to use DELTA EMI filter to have the best interference elimination performance.

We assure that it can comply with following rules when AC motor drive and EMI filter are installed and wired according to user manual:

- **EN61000-6-4**
- **EN61800-3: 1996**
- **EN55011: (1991) Class A Group 1 (1st Environment, restricted distribution)**
- **European Standards: EN12015 & EN12016**

General precaution

1. EMI filter and AC motor drive should be installed on the same metal plate.
2. Install AC motor drive on footprint EMI filter or install EMI filter as close as possible to the AC motor drive.
3. Wire as short as possible.
4. Metal plate should be grounded.
5. The cover of EMI filter and AC motor drive or grounding should be fixed on the metal plate and the contact area should be as large as possible.

Choose suitable motor cable and precautions

Improper installation and choice of motor cable will affect the performance of EMI filter. Be sure to observe the following precautions when selecting motor cable.

1. Use the cable with shielding (double shielding is the best).
2. The shielding on both ends of the motor cable should be grounded with the minimum length and maximum contact area.
3. Remove any paint on metal saddle for good ground contact with the plate and shielding.

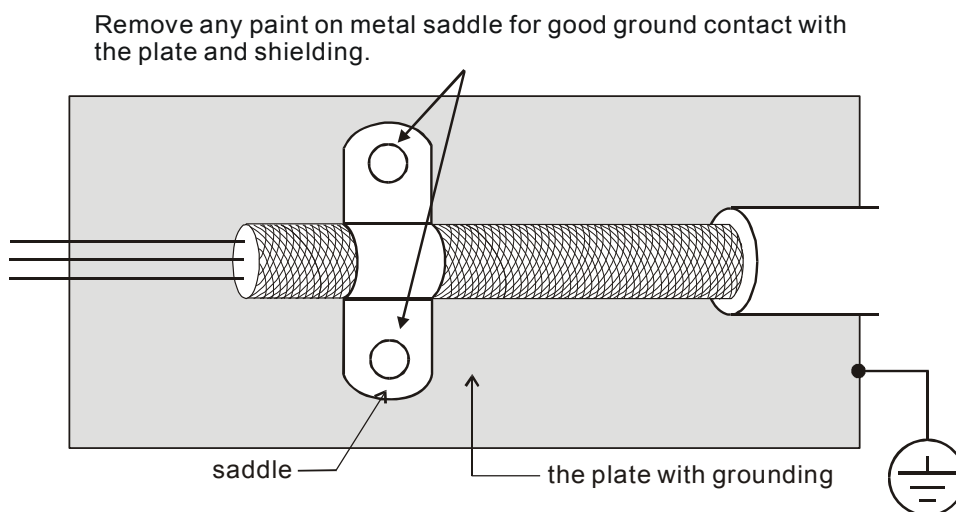

Figure 1

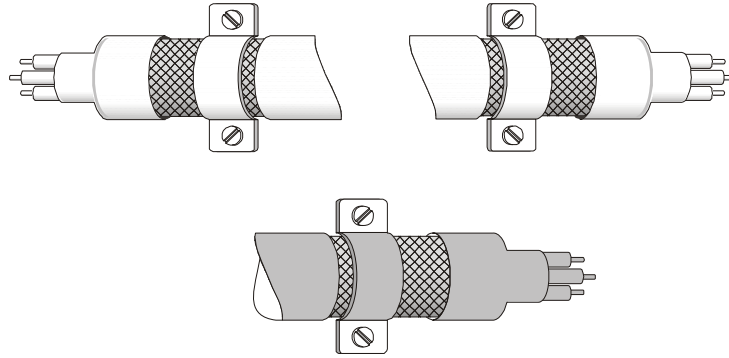

Figure 2

The length of motor cable

1. Required cable length when the motor drive is at full load.
 - a. Non-shielded cable: For models of 5.5kW (7.5HP) and below, the maximum cable length is 100m (328ft). For 7.5kW(10HP) and above, the maximum cable length is 200m(656ft)
 - b. Shielded cable: For models of 5.5kw (7.5HP) and below, the maximum cable length is 50m (165ft). For models of 7.5kW (10HP), the maximum cable length is 100m (328ft).
 - c. In order to be compatible with the European Standards EN12015 & EN12016, it is required not to only follow the precautions mentioned on page6-10, but also required to satisfy one of the two conditions below:
 - Use shielded cables
 - The length of motor cable has to be shorter than 2m (6ft).

If the cable length is longer than the recommended lengths above, it will be necessary to install an output reactor.

NOTE

- If the length is too long, the stray capacitance between cables will increase and may cause leakage current. It will activate the protection of over current, increase leakage current or not insure the correction of current display. The worst case is that AC motor drive may damage.
- If more than one motor is connected to the AC motor drive, the total wiring length is the sum of the wiring length from AC motor drive to each motor.
- For the 460V series AC motor drive, when an overload relay is installed between the drive and the motor to protect motor overheating, the connecting cable must be shorter than 50m. However, an overload relay malfunction may still occur. To prevent the malfunction, install an output reactor (optional) to the drive or lower the carrier frequency setting (Pr.00-12).

2. Consequence of the surge voltages on the motor

When a motor is driven by an AC motor drive of PWM type, the motor terminals will experience surge voltages easily due to components conversion of AC motor drive and cable capacitance. When the motor cable is very long (especially for the 460V series), surge voltages may reduce insulation quality. To prevent this situation, please follow the rules below:

- Use a motor with enhanced insulation.
- Connect an output reactor (optional) to the output terminals of the AC motor drive
- The length of the cable between AC motor drive and motor should be as short as possible (10 to 20 m or less)
- For models 7.5hp and above:

Insulation level of motor	1000V	1300V	1600V
460VAC input voltage	20m(66ft)	100m(328ft)	400m(1312ft)
230VAC input voltage	400m(1312ft)	400m(1312ft)	400m(1312ft)

- For models 5hp and less:



Insulation level of motor	1000V	1300V	1600V
460VAC input voltage	20m(66ft)	50m(165ft)	50m(165ft)
230VAC input voltage	100m(328ft)	100m(328ft)	100m(328ft)



NOTE

Never connect phase lead capacitors or surge absorbers to the output terminals of the AC motor drive.

Description of LED Functions

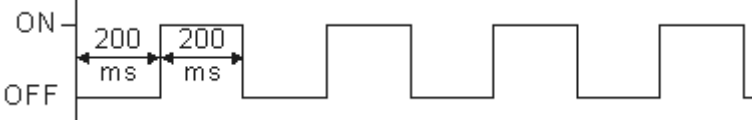
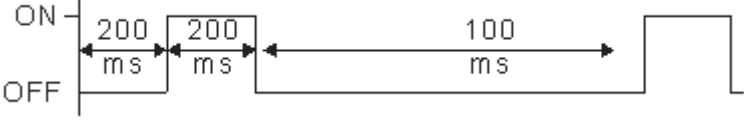
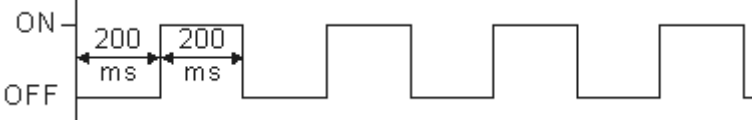
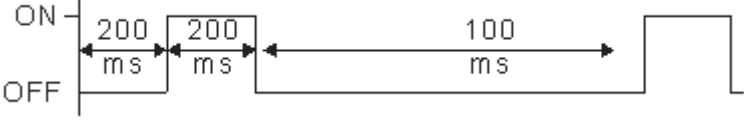
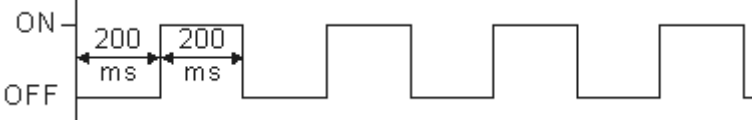
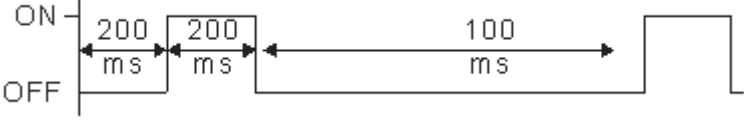
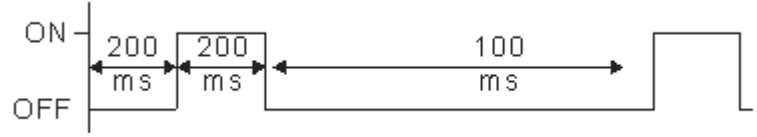
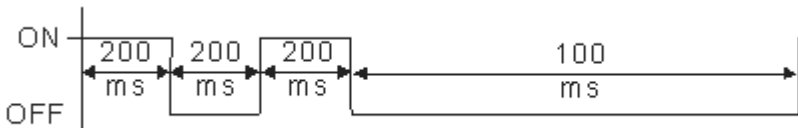
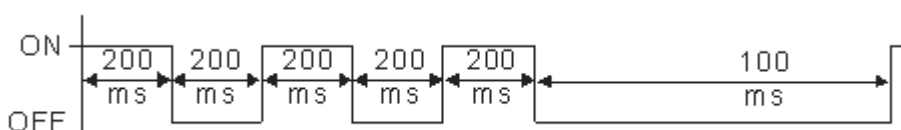
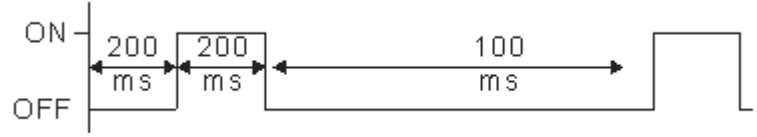
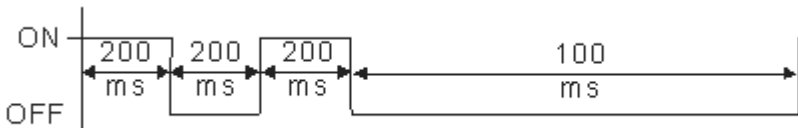
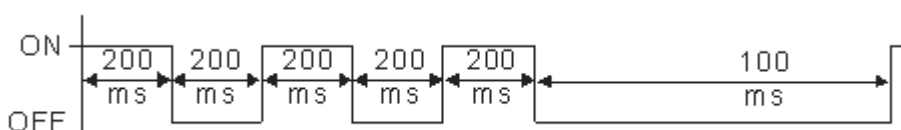
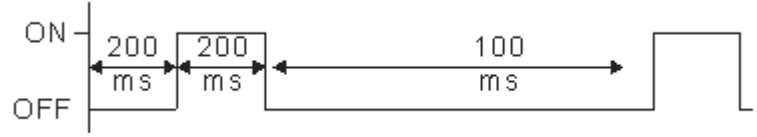
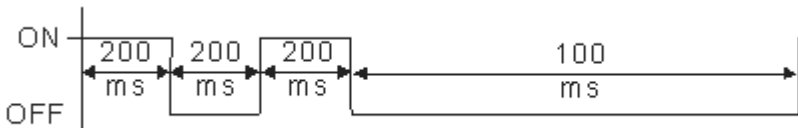
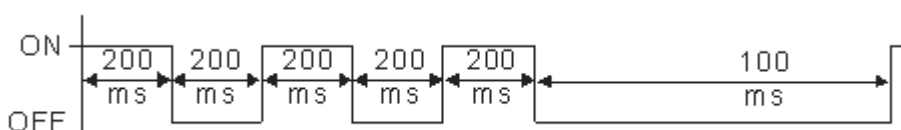
LED	Description												
	Steady ON: operation indicator of the AC motor drive, including DC brake, zero speed, standby, restart after fault and speed search. Blinking: drive is decelerating to stop or in the status of base block. Steady OFF: drive doesn't execute the operation command												
	Steady ON: stop indicator of the AC motor drive. Blinking: drive is in the standby status. Steady OFF: drive doesn't execute "STOP" command.												
	Operation Direction LED 『Green light= Forward』; 『Red light= Reversely』 Steady ON: the drive is running forward. Blinking: the drive is changing direction. Steady Off: the drive is running reversely.												
CANopen ~"RUN"	RUN (Green light):												
	<table border="1" data-bbox="359 622 1458 680"> <thead> <tr> <th data-bbox="359 622 491 680">LED status</th> <th data-bbox="491 622 1458 680">Condition/State</th> </tr> </thead> <tbody> <tr> <td data-bbox="359 680 491 743">OFF</td> <td data-bbox="491 680 1458 743">CANopen at initial No LED</td> </tr> <tr> <td data-bbox="359 743 491 909">Blinking</td> <td data-bbox="491 743 1458 909"> CANopen at pre-operation  </td> </tr> <tr> <td data-bbox="359 909 491 1075">Single flash</td> <td data-bbox="491 909 1458 1075"> CANopen at stopped  </td> </tr> <tr> <td data-bbox="359 1075 491 1144">ON</td> <td data-bbox="491 1075 1458 1144">CANopen at operation status No LED</td> </tr> </tbody> </table>	LED status	Condition/State	OFF	CANopen at initial No LED	Blinking	CANopen at pre-operation 	Single flash	CANopen at stopped 	ON	CANopen at operation status No LED		
	LED status	Condition/State											
	OFF	CANopen at initial No LED											
	Blinking	CANopen at pre-operation 											
Single flash	CANopen at stopped 												
ON	CANopen at operation status No LED												
ERR (Red light):													
CANopen ~"ERR"	<table border="1" data-bbox="359 1205 1458 1263"> <thead> <tr> <th data-bbox="359 1205 491 1263">LED status</th> <th data-bbox="491 1205 1458 1263">Condition/ State</th> </tr> </thead> <tbody> <tr> <td data-bbox="359 1263 491 1294">OFF</td> <td data-bbox="491 1263 1458 1294">No Error</td> </tr> <tr> <td data-bbox="359 1294 491 1496">Single flash</td> <td data-bbox="491 1294 1458 1496"> One message fail  </td> </tr> <tr> <td data-bbox="359 1496 491 1697">Double flash</td> <td data-bbox="491 1496 1458 1697"> Guarding fail or heartbeat fail  </td> </tr> <tr> <td data-bbox="359 1697 491 1899">Triple flash</td> <td data-bbox="491 1697 1458 1899"> SYNC fail  </td> </tr> <tr> <td data-bbox="359 1899 491 1926">ON</td> <td data-bbox="491 1899 1458 1926">Bus off</td> </tr> </tbody> </table>	LED status	Condition/ State	OFF	No Error	Single flash	One message fail 	Double flash	Guarding fail or heartbeat fail 	Triple flash	SYNC fail 	ON	Bus off
	LED status	Condition/ State											
	OFF	No Error											
	Single flash	One message fail 											
	Double flash	Guarding fail or heartbeat fail 											
Triple flash	SYNC fail 												
ON	Bus off												
OFF													
Single flash													
Double flash													
Triple flash													
ON													

Dimension

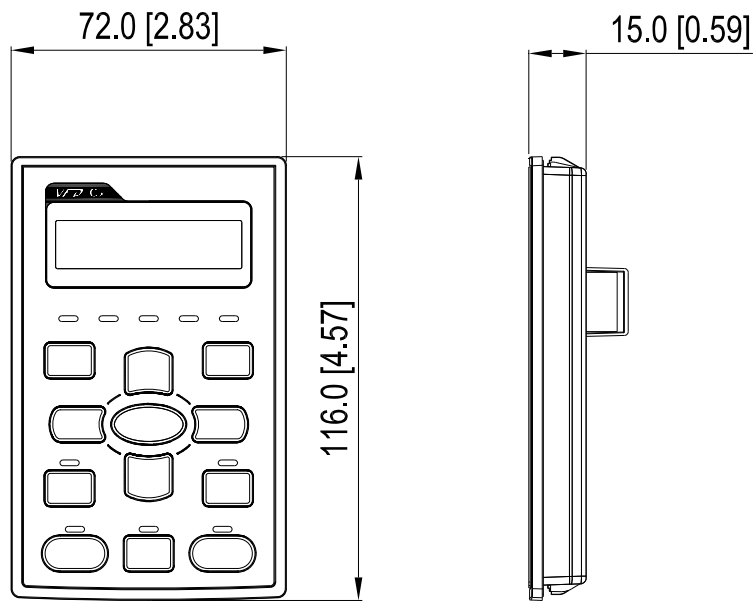

RJ45 Extension Lead for Digital Keypad

Part #	Description
CBC-K3FT	3 feet RJ45 extension lead (approximately 0.9m)
CBC-K5FT	5 feet RJ45 extension lead (approximately 1.5 m)
CBC-K7FT	7 feet RJ45 extension lead (approximately 2.1 m)
CBC-K10FT	10 feet RJ45 extension lead (approximately 3 m)
CBC-K16FT	16 feet RJ45 extension lead (approximately 4.9 m)

6-8 USB/RS-485 Communication Interface IFD6530

⚠ Warning

- ✓ Read thoroughly this section before installation and putting it into use.
- ✓ The content of this section and the driver file may be revised without prior notice. Consult our distributors or download the most updated instruction/driver version at [AC Motor Drive > Optional](#)

Introduction

IFD6530 is a convenient RS-485-to-USB converter, which does not require external power-supply and complex setting process. It supports baud rate from 75 to 115.2kbps and auto switching direction of data transmission. In addition, it adopts RJ-45 in RS-485 connector for users to wire conveniently. And its tiny dimension, handy use of plug-and-play and hot-swap provide more conveniences for connecting all DELTA IABU products to your PC.

Applicable Models: All DELTA IABU products.

■ Application & Dimension:

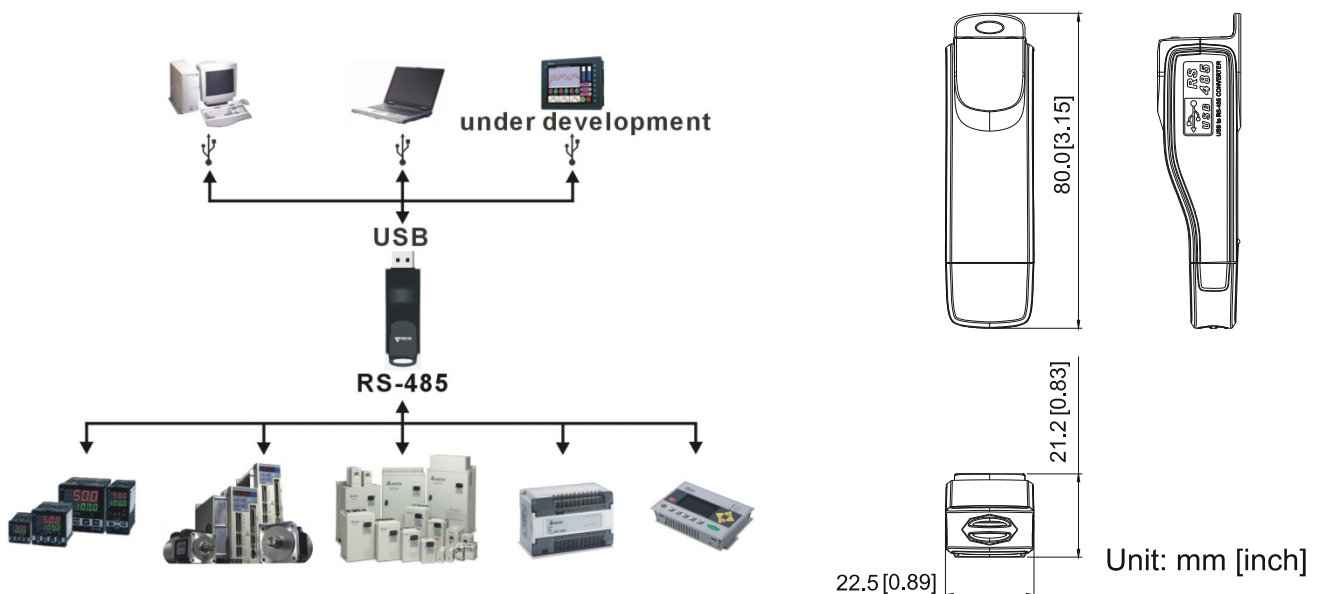

Specifications

Power supply	No external power is needed
Power consumption	1.5W
Isolated voltage	2,500VDC
Baud rate	75, 150, 300, 600, 1,200, 2,400, 4,800, 9,600, 19,200, 38,400, 57,600, 115,200 bps
RS-485 connector	RJ-45
USB connector	A type (plug)
Compatibility	Full compliance with USB V2.0 specification
Max. cable length	RS-485 Communication Port: 100 m
Support RS-485 half-duplex transmission	

RJ-45

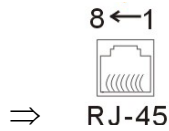

PIN	Description
1	Reserved
2	Reserved
3	GND
4	SG-

PIN	Description
5	SG+
6	GND
7	Reserved
8	+9V

Preparation before Installing Driver

Extract the driver file (IFD6530_Drivers.exe) by following steps. You could find driver file (IFD6530_Drivers.exe) in the CD supplied with IFD6530.

Note: DO NOT connect IFD6530 to PC before extracting the driver file.

STEP 1

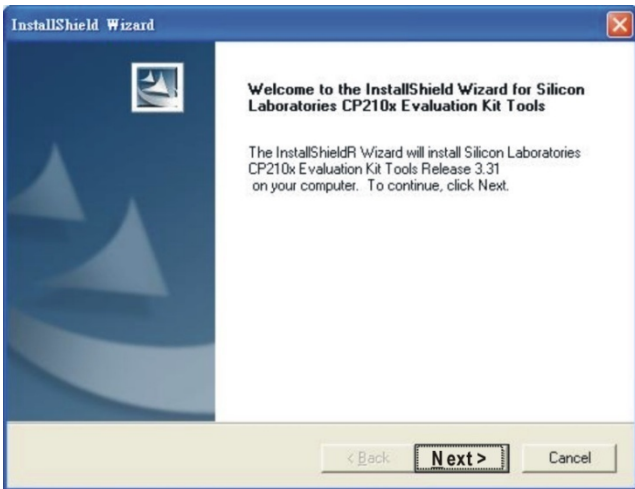

STEP 2

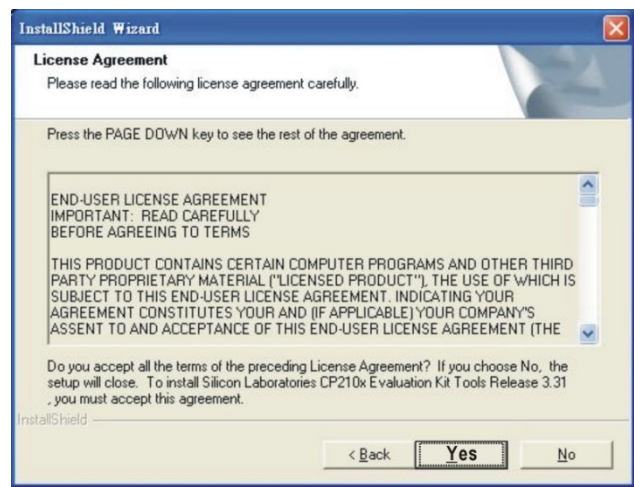

STEP 3

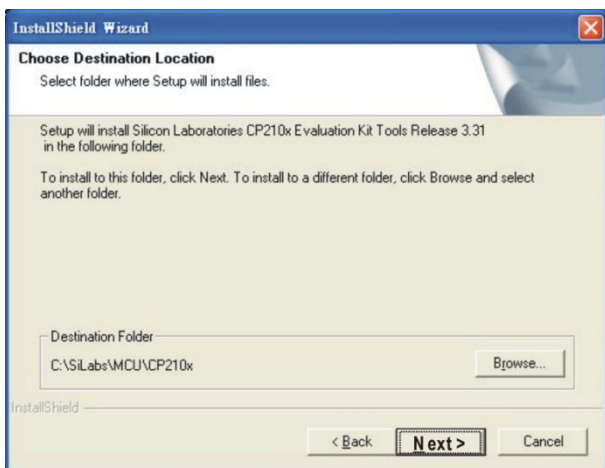

STEP 4

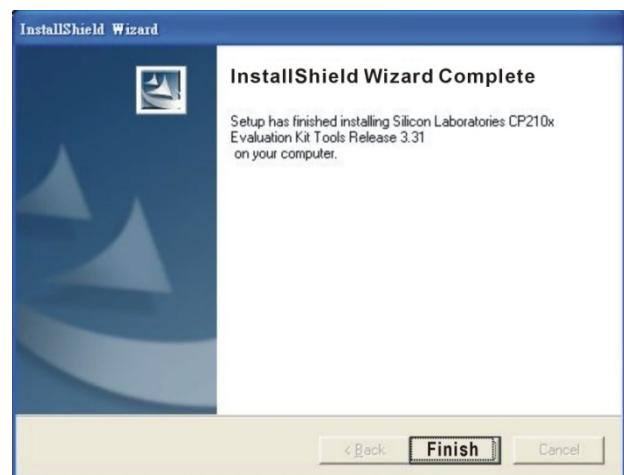

STEP 5

You should have a folder marked SiLabs under drive C. c:\ SiLabs

Installing the Driver

After connecting IFD6530 to PC, install driver by following steps below.

STEP 1



STEP 2

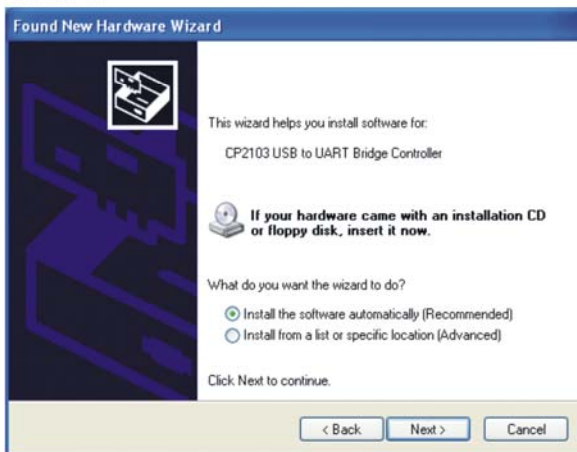

OR

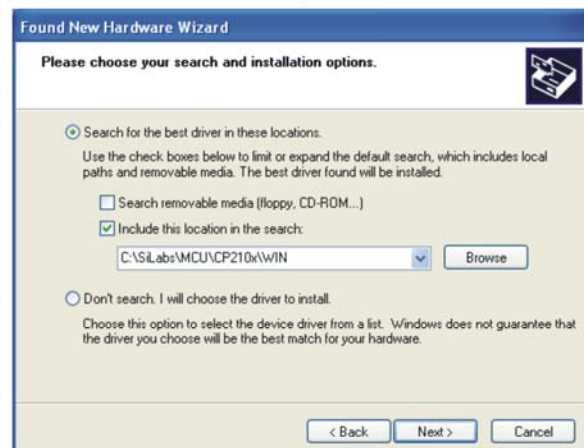
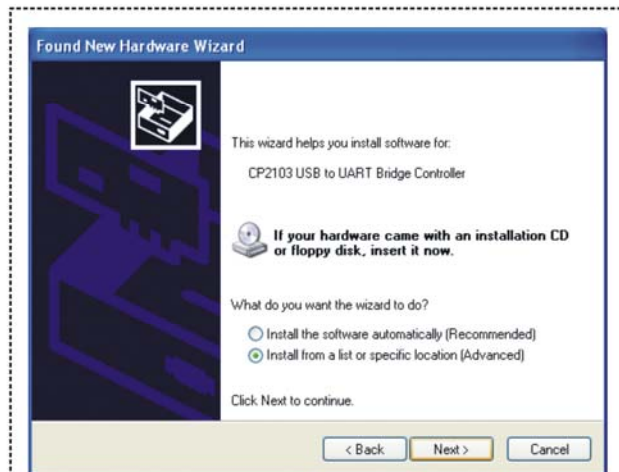

Browse and select directory, or enter
C:\SiLabs\MCU\CP210x\WIN

STEP 3

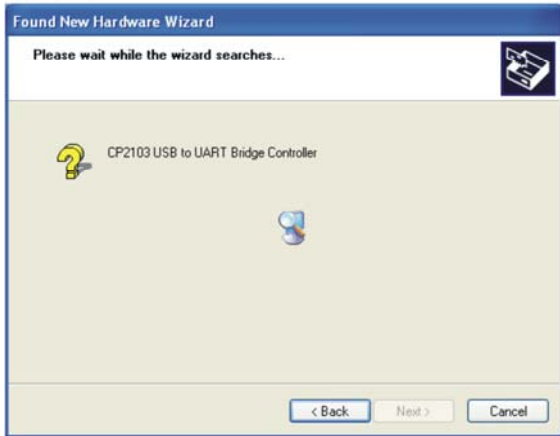

STEP 4



STEP 5

Repeat Step 1 to Step 4 to complete COM PORT setting.

LED Display

1. Steady Green LED ON: power is ON.
2. Blinking orange LED: data is transmitting.

07 Option Cards

Select applicable option cards for your drive or contact local distributor for suggestion.

To prevent drive damage during installation, remove the digital keypad and the cover before wiring. Refer to the following instruction.

Remove the top cover

Frame B, C & D Screw Torque: Kg-cm [lb.-in.]

Step 1

Loosen the 4 screws.
Then remove the top cover.

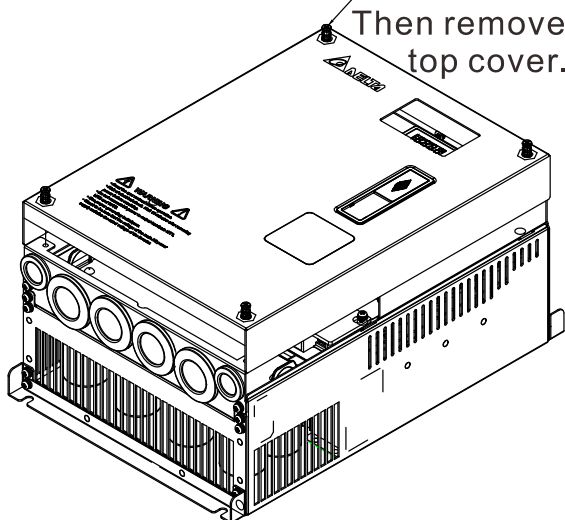

Step 2

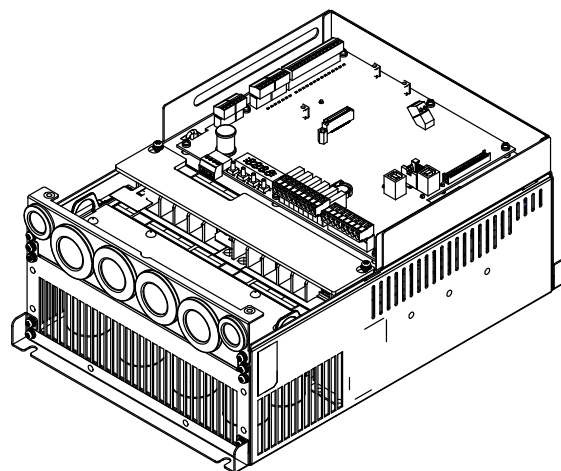

Step 3

Put back the top cover.
Then fasten the 4 screws,
Screw torque 15kgf-cm

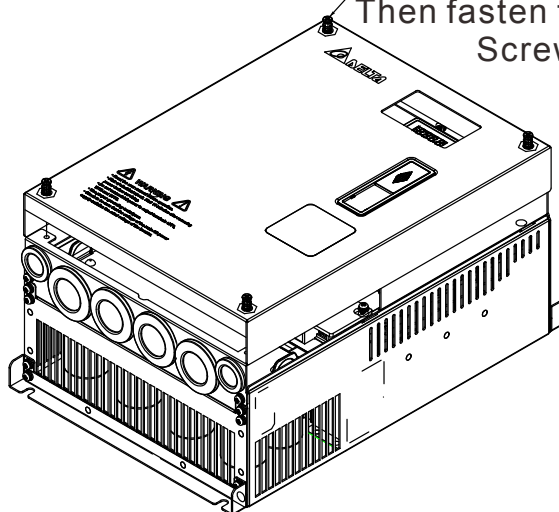

Frame E Screw Torque: Kg-cm [lb.-in.]

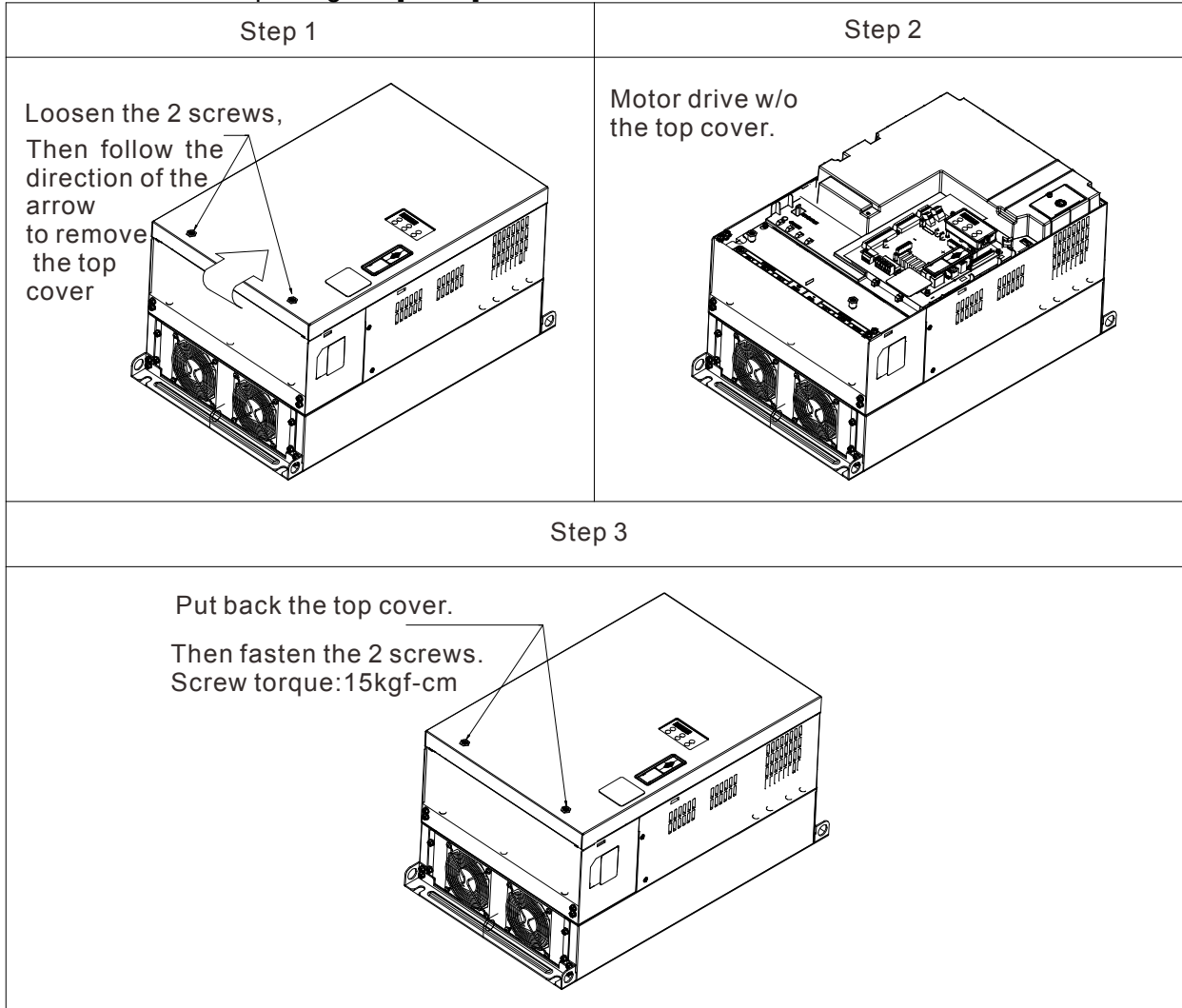

Vertical view of the motor drive & Screw's Specifications:

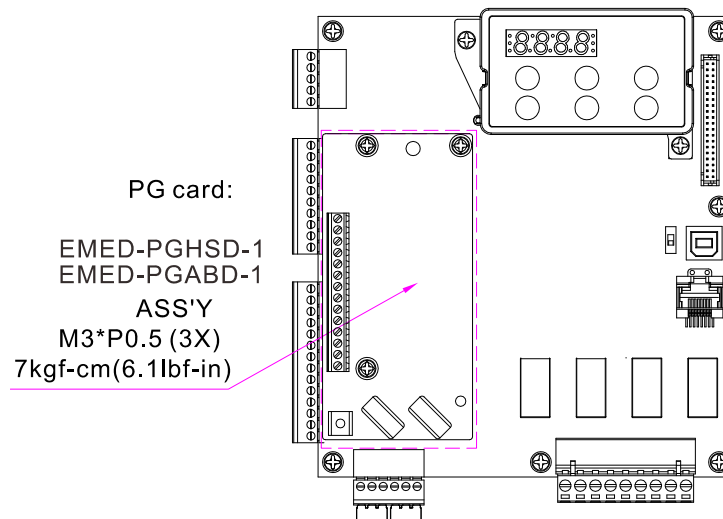

Screws' Specification for Option Card Terminal:

PG Card	Wire Gauge	Torque
EMED-PGABD-1	30~16AWG (0.05~1.31mm ²)	1.6Kg-cm [1.4lb-in]
EMED-PGHSD-1	30~16AWG (0.05~1.31mm ²)	1.6Kg-cm [1.4lb-in]

7-1 EMED-PGABD-1

Applicable encoder: A/B/Z & U/V/W Absolute Encoders

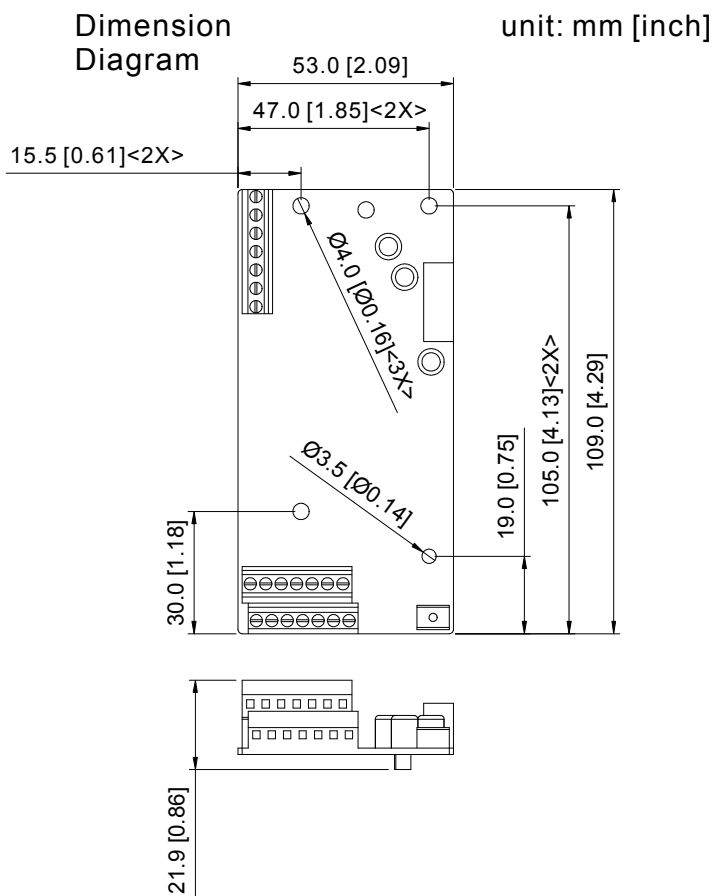
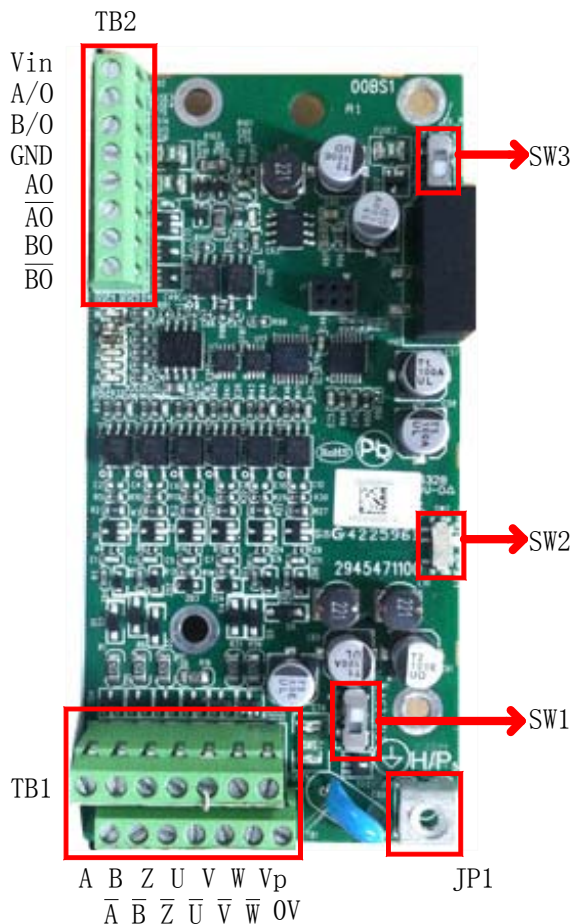

NOTE

- Verify if the SW1 is set to the correct output voltage before power on.
- Keep away from any high voltage line when wiring the motor drive to avoid interference.

Terminal Specification

Terminals		Descriptions
TB2	Vin	Terminal for voltage input, to adjust the amplitude of output voltage at terminal A/O and terminal B/O. It also provides a 5V voltage to support line driver's signal. Vin voltage range: 8~24V, Max: 24V.
	A/O, B/O	Output signal of the push-pull frequency divider Factory setting: Output amplitude is about +24V. Use SW2 to cut off the internal default power. Input required power (i.e. output voltage's amplitude) DVI voltage range Max: 24V (Push-Pull Voltage Output) Max. output frequency: 100kHz Support frequency dividing output, the frequency dividing range: 1~31Hz.
	GND	Common ground terminal connecting to the host controller and the motor drive.
	AO, /AO, BO, /BO	Line driver pulse output signal (Line Driver RS422) Max. output frequency: 150kHz Support frequency dividing output, the frequency dividing range: 1~31Hz.
TB1	VP	Power output of encoder Note: Use SW1 to set up output voltage Voltage: +5V±0.5V or +12V±1V Current: 200mA max
	0V	Common power terminal of encoder
	A, \bar{A} , B, \bar{B} , Z, \bar{Z}	Incremental encoder signal input terminal Types of input signal: line drive, voltage output, push-pull, open-collector) Note: Different input signal needs different wiring method. See user manual for wiring diagrams. Max. input frequency: 150kHz
	U, \bar{U} , V, \bar{V} , W, \bar{W}	Absolute encoder signal input terminal Types of input signal: line drive, voltage, push-pull, open-collector) Note: Different input signal needs different wiring method. See user manual for wiring diagrams Max. input frequency: 150kHz
JP1		Ground Terminal Connect the power supply of the motor drive to the ground. Support PG shielding
	SW1	Switch between encoder's 5V/12V power.
	SW2	Offline Detection Switch. Switch the SW2 to Line-D side to enable offline detection when Line-D input signal. Switch the SW2 to OPEN-C side to disable offline detection function when OPEN-C input signal.
	SW3	Switch of power supply for frequency division Switch SW3 to INP side to provide 24V power for internal use. Switch SW3 to EXP side to provide 24V power for external use (client).

Applicable encoders:

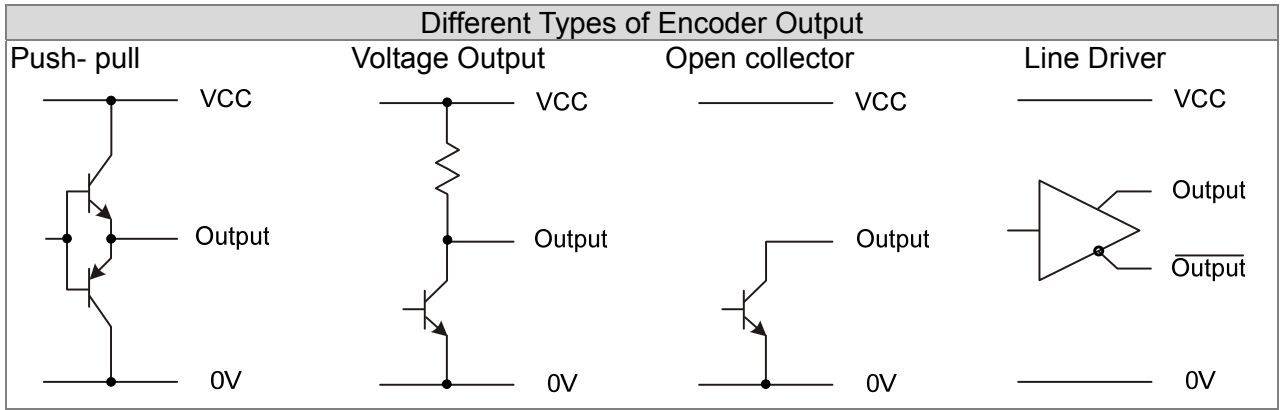

NOTE

- Verify if the SW1 is set to the correct output voltage before power on.
- Keep away from any high voltage line when wiring the motor drive to avoid interference

Wiring Diagram

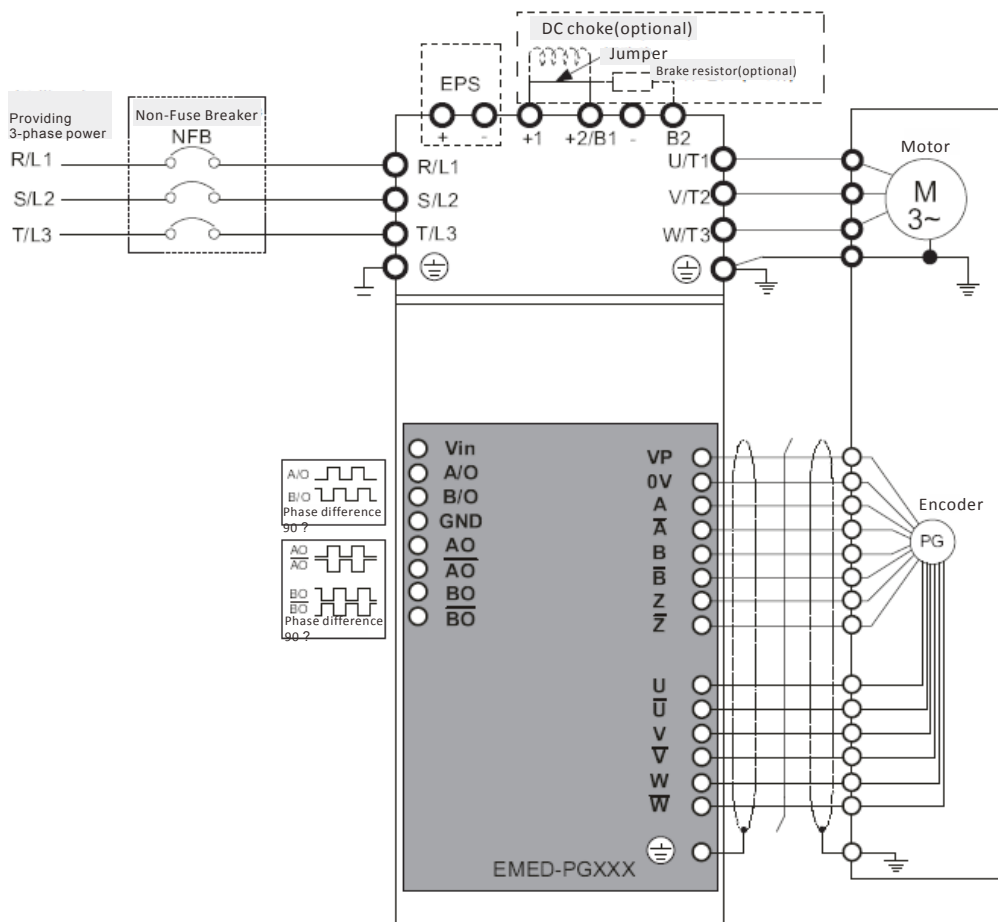

Set up the Signal of the Frequency Division

- ① After the encoder input a PULSE signal, there will be an output signal of the division factor “n.” Use Pr10-29 <Output of PG card’s frequency division> to set up.
- ② Setup of Pr10-29 <PG card’s frequency division>:
Output of decimal frequency division setting. Range of the division factor “n”: 1~31.
- ③ Pr10-30 <Mode of output of PG card’s frequency division>

Bit3	Bit2	Bit1	Bit0
X	X	OUT/M	IN/M

OUT/M: Mode of pulse output of frequency division;

IN/M: Mode of pulse input of frequency division;

“X” is for backup while “0” is a value to write.

Setting and Description of Input Mode (IN/M) & Output Mode (OUT/M):

OUT/M	IN/M	Division factor	
		A is ahead of B	B is ahead of A
0	0		
1	0		
X	1		

NOTE

- In the waveform A-/A, B-/B are the PG card input signals; AO- \overline{AO} , BO- \overline{BO} are the differential output frequency division signals. (Use a differential probe to measure.)
- Division factor “n”: Set 15 to have the input signal divided by 15.)
- When OUT/M, IN/M set as 0.0, the PG card input signal A-/A, B-/B are square waves while AO- \overline{AO} , BO- \overline{BO} are frequency division output.
- When OUT/M, IN/M are set as 1.0, the PG card input signal A-/A, B-/B are square waves while the BO- \overline{BO} is the phase indicator of A and B
- When OUT/M, IN/M are set as X, B-/B phase has to be direction indication input signal (e.g. When B-/B is LOW, it means A is ahead of B. When B-/B is HIGH, it means B is ahead of A)
- Take Pr10-29 and Pr10-30 as examples. When frequency division value =15, OUT/M =1, IN/M = 0, set Pr10-29 = 15 and Pr10-30 = 0002h.
Set Pr100-29 =15,
Set Pr10-30 =0002h

Bit3	Bit2	Bit1	Bit0
X	X	1	0

7-2 EMED-PGHSD-1

Applicable encoder:

Sine-wave: Heidenhain ERN1387

EnDat2.1: Heidenhain EQN425, EQN1325, ECN113, ECN413, ECN1113, ECN1313

SICK HIPERFACE: SRS50/60

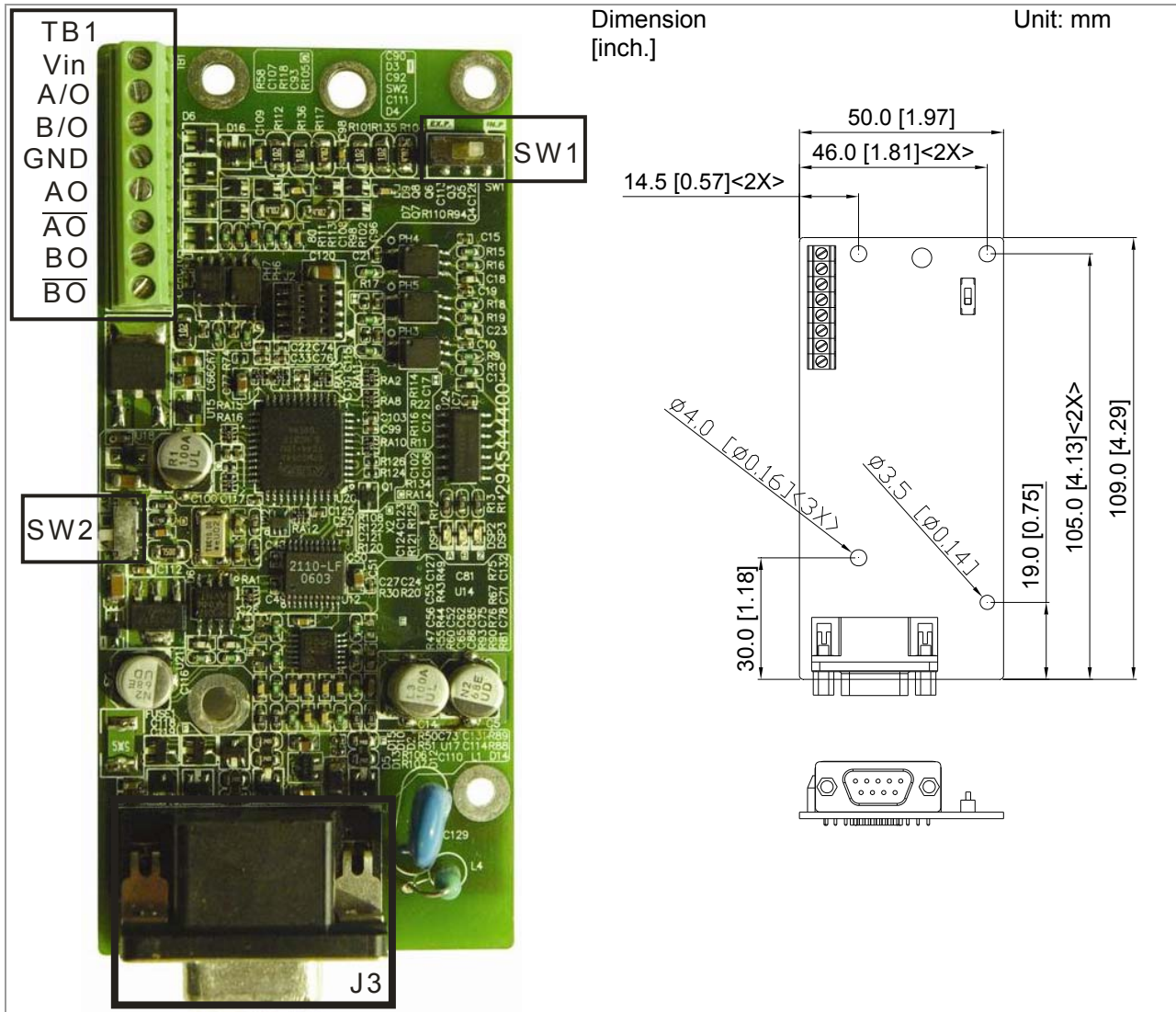

※ Support Heidenhain ERN1387, EnDat2.1, HIPERFACE

Terminals		Descriptions
TB1	Vin	Voltage Input: (to adjust output voltage amplitude of the push-pull pulse) Max. input voltage: 24VDC Max. input current: 30mA
	GND	Common power input/ signal output terminal
	A/O, B/O	Push-Pull Voltage Output Max. output frequency: 50kHz
	AO, /AO, BO, /BO	Line Driver RS422 Max. input frequency: 100kHz
J3 (D-SUB female connector)		Encoder signal input terminal
SW1		Frequency divider output power terminal selection INP: Power supplied by PG card EXP: Power from an external source
SW2		Encoder's voltage output terminal (UP) NOTE: The output voltage of the terminal SW2 can be modified by simply switching the direction of the dip switch. 5V: 5Vdc 8V: 8Vdc

EMED-PGHSD-1(Terminal J3) pin definition correspond to each ENCODER type

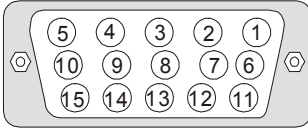

Terminal#	Heidenhain ERN1387	Heidenhain ECN1313	HIPERFACE®
1	B-	B-	REFSIN
2	-	-	-
3	R+	DATA	DATA+
4	R-	/DATA	DATA-
5	A+	A+	+COS
6	A-	A-	REFCOS
7	0V	0V	GND
8	B+	B+	+SIN
9	UP	UP	UP
10	C-	-	-
11	C+	-	-
12	D+	-	-
13	D-	-	-
14	-	/CLOCK	-
15	-	CLOCK	-

Terminal Function:

Terminals	Descriptions	Specifications
UP(VP)	The output voltage used by the encoder. Use the dip switch on SW2 to change the output voltage to +5V or +8V	Voltage: +5.1Vdc±0.3V; +8.4Vdc±1.5V Current: 200mA max.
0V	Encoder common power terminal	Reference level of encoder's power.
A+, A-, B+, B-, R+, R-	Encoder sine wave differential signal input (Incremental signal)	Input frequency: 40k Hz max. 0.8...1.2Vss (≈1Vss; Z ₀ =120Ω) 0.2V...0.85V (≈0.5V; Z ₀ =120Ω)
+SIN, +COS, REFSIN, REFCOS	Encoder sine wave differential signal input	Input frequency: 20k Hz max. 0.9...1.1V REFSIN/REFCOS
C+, C-, D+, D-	Encoder sine wave differential signal input (Absolute signal)	 0.8...1.2Vss (≈1Vss; Z ₀ =1kΩ)
DATA+(DATA), DATA-(/DATA)	RS485 communication interface	Terminal resistance is about 130Ω

	CLK+, CLK-	CLOCK differential output for ENDAT.	Line Driver RS422 Level output
--	------------	--------------------------------------	--------------------------------

Set up the Signal of the Frequency Division

- ① After the encoder input a PULSE signal, there will be an output signal of the division factor "n." Use Pr10-29 <Output of PG card's frequency division> to set up.
- ② Pr10-29 <Mode of output of PG card's frequency division> :
Output of decimal frequency division setting. Range of the division factor "n": 1~31.

Setting and Description of Input Mode (IN/M) & Output Mode (OUT/M):

OUT/M	IN/M	Division factor	
		A is ahead of B	B is ahead of A
0	0		
1	0		
X	1		

NOTE

- In the waveform A-/A, B-/B are the PG card input signals; AO- \overline{AO} , BO- \overline{BO} are the differential output frequency division signals. (Use a differential probe to measure.)
- Division factor "n": Set 15 to have the input signal divided by 15.)
- When OUT/M, IN/M set as 0.0, the PG card input signal A-/A, B-/B are square waves while AO- \overline{AO} , BO- \overline{BO} are frequency division output.
- When OUT/M, IN/M are set as 1.0, the PG card input signal A-/A, B-/B are square waves while the BO- \overline{BO} is the phase indicator of A and B.
- When OUT/M, IN/M are set as X, B-/B phase has to be direction indication input signal (e.g. When B-/B is LOW, it means A is ahead of B. When B-/B is HIGH, it means B is ahead of A)
- Take Pr10-29 and Pr10-30 as examples. When frequency division value = 15, OUT/M = 1, IN/M = 0, set Pr10-29 = 15 and Pr10-30 = 0002h.
Set Pr100-29 = 15,
Set Pr10-30 = 0002h

Bit3	Bit2	Bit1	Bit0
X	X	1	0

7-3 EMED-PGHSD-2

Applicable encoder:

Sine-wave: Heidenhain ERN1387

EnDat2.1: Heidenhain EQN425, EQN1325, ECN113, ECN413, ECN1113, ECN1313

SICK HIPERFACE: SRS50/60

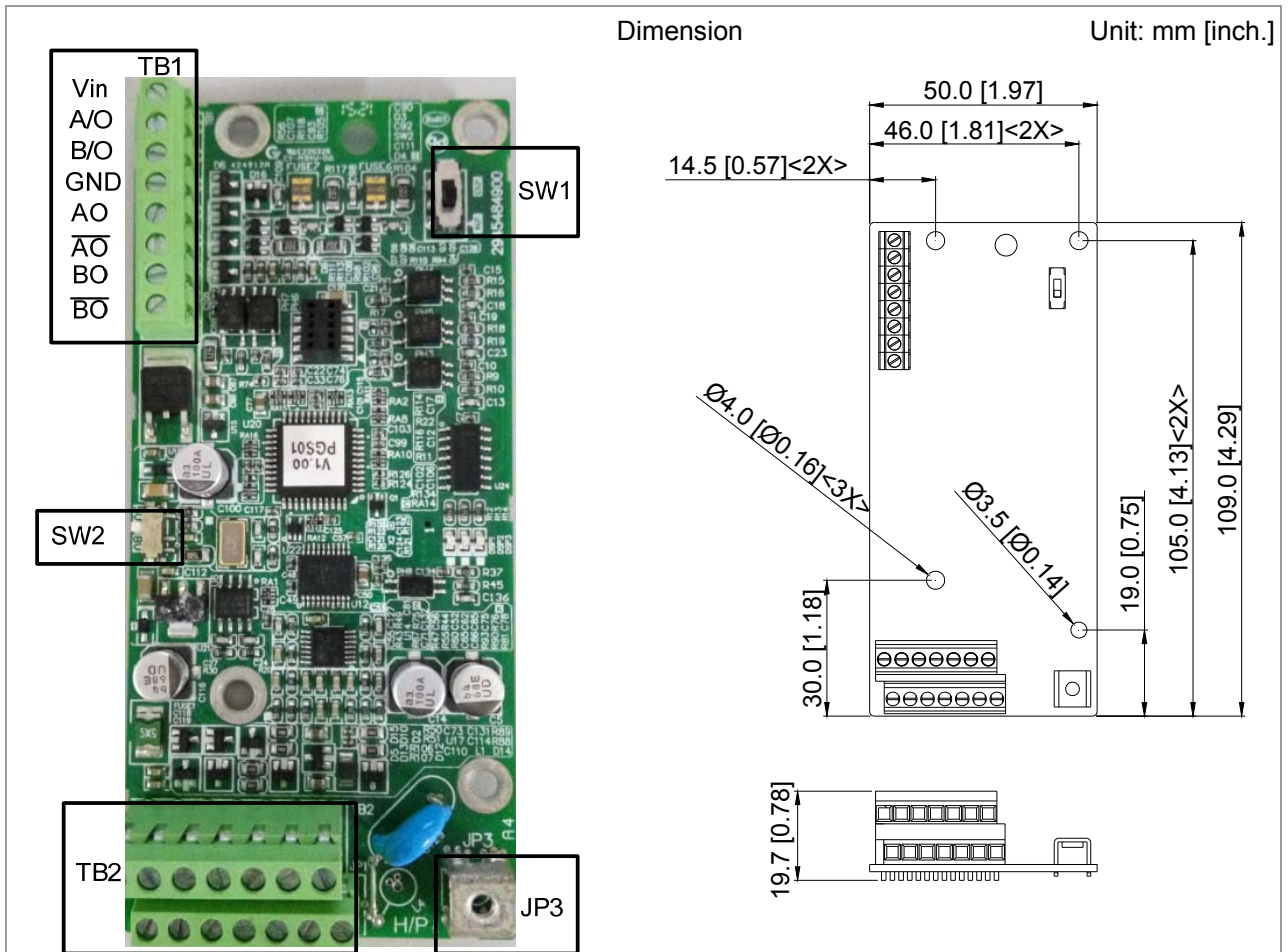

※ SupportHeidenhain ERN1387, EnDat2.1, HIPERFACE

Terminals		Descriptions
TB1	Vin	Voltage Input: (to adjust output voltage amplitude of the push-pull pulse) Max. input voltage: 24VDC Max. input current: 30mA
	GND	Common power input/ signal output terminal
	A/O, B/O	Push-Pull Voltage Output Max. output frequency: 50kHz
	AO, /AO, BO, /BO	Line Driver RS422 Max. input frequency 100kHz
TB2		Encoder signal input terminal
JP3		Ground Terminal Connect the power supply of the motor drive to the ground. Support PG shielding
SW1		Frequency divider output power terminal selection INP: Power supplied by PG card EXP: Power from an external source
SW2		Encoder's voltage output terminal (UP) NOTE: The output voltage of the terminal SW2 can be modified by simply switching the direction of the dip switch. 5V: 5Vdc 8V: 8Vdc

EMED-PGHSD-2(Terminal TB2) pin definition corresponds to each ENCODER type.

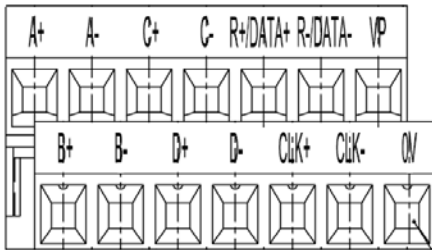

Terminals	Heidenhain ERN1387	Heidenhain ECN1313	HIPERFACE®
B-	B-	B-	REFSIN
	-	-	-
R+/DATA+	R+	DATA	DATA+
R-/DATA-	R-	/DATA	DATA-
A+	A+	A+	+COS
A-	A-	A-	REFCOS
0V	0V	0V	GND
B+	B+	B+	+SIN
VP	UP	UP	UP
C-	C-	-	-
C+	C+	-	-
D+	D+	-	-
D-	D-	-	-
CLK-	-	/CLOCK	-
CLK+	-	CLOCK	-

Terminal Function

Terminals	Descriptions	Specifications
UP(VP)	The output voltage used by the encoder. Use the dip switch on SW2 to change the output voltage to +5V or +8V	Voltage: +5.1Vdc±0.3V; +8.4Vdc±1.5V Current: 200mA max.
0V	Encoder common power terminal	Reference level of encoder's power.
A+, A-, B+, B-, R+, R-	Encoder sine wave differential signal input (Incremental signal)	Input frtequency: 40k Hz max 0.8...1.2V _{ss} (≈1V _{ss} ; Z ₀ =120Ω)
+SIN, +COS REFSIN, REFCOS	Encoder sine wave differential signal input (Incremental signal)	Input frequency: 20k Hz max. SIN COS REFSIN/REFCOS 0.9...1.1V 0.2V...0.85V (≈0.5V; Z ₀ =120Ω)
C+, C-, D+, D-	Encoder sine wave differential signal input (Absolute signal)	 C+ D+ 0.8...1.2V _{ss} (≈1V _{ss} ; Z ₀ =1kΩ)

DATA+(DATA), DATA-(/DATA)	RS485 communication interface	Terminal resistance is about 130Ω
CLOCK, /CLOCK	CLOCK differential output for ENDAT	Line Driver RS422 Level output

NOTE

- Verify if the SW1 is set to the correct output voltage before power on.
- Keep away from any high voltage line when wiring the motor drive to avoid interference.

Wiring Diagram

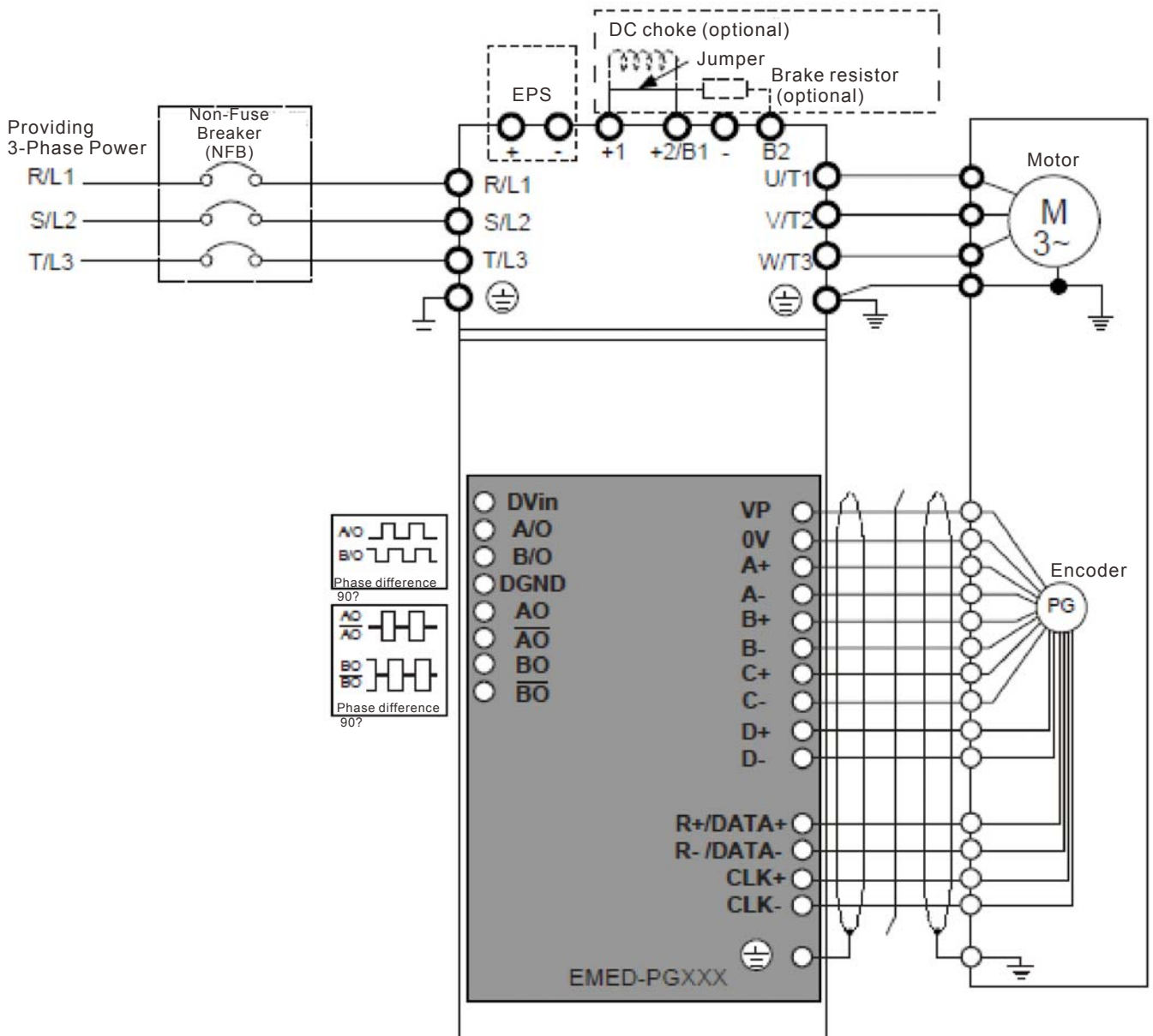

Set up the Signal of the Frequency Division

- ① After the encoder input a PULSE signal, there will be an output signal of the division factor "n." Use Pr10-29 <Output of PG card's frequency division> to set up.
- ② Setup of Pr10-29 <PG card's frequency division>: Output of decimal frequency division setting. Range of the division factor "n": 1~31.

08 Specifications

230V Series

Frame Size		B			C			D			E	
Model VFD-__ED23/21S		022*	037*	040	055	075	110	150	185	220	300	370
Applicable Motor Output(KW)		2.2	3.7	4.0	5.5	7.5	11	15	18.5	22	30	37
Applicable Motor Output (HP)		3	5	5	7.5	10	15	20	25	30	40	50
Output Rating	Rated Output Capacity(KVA)	4.8	6.8	7.9	9.5	12.5	19	25	29	34	46	55
	Rated Output Current (A)	12.0	17	20.0	24.0	30.0	45.0	58.0	77.0	87.0	132.0	161.0
	Maximum Output Voltage (V)	3-phase Proportional to Input Voltage										
	Output Frequency	0.00~400Hz										
	Carrier Frequency	2~15kHz									2~9kHz	
	Rated Output Maximum Carrier Frequency	8kHz			10kHz			8kHz			6kHz	
Input Rating	Input Current(A)	24	34	20	23	30	47	56	73	90	132	161
	Rated Voltage /Frequency	1-phase		3-phase								
	Voltage Tolerance	200~240V 50/60Hz										
	Frequency Tolerance	±10% (180~264V)										
Cooling Method	Fan cooled											
Weight (kg)	6	6	6	8	10	10	13	13	13	13	36	36



*VFD022ED21S & VFD037ED21S are 1-phase input models.

460V Series

Frame Size		B	C				D			E			
Model VFD-__ED43S		040	055	075	110	150	185	220	300	370	450	550	750
Applicable Motor Power(KW)		4.0	5.5	7.5	11	15	18.5	22	30	37	45	55	75
Applicable Motor power(HP)		5	7.5	10	15	20	25	30	40	50	60	75	100
Output Rating	Rated Output Capacity (KVA)	9.2	10.4	13.5	18.3	24	30.3	36	46.2	63.7	80	96.4	116.3
	Rated Output Current (A)	11.5	13	17	23	30	38	45	58	80	100	128	165
	Maximum Output Voltage(V)	3-phase Proportional to Input Voltage											
	Output Frequency	0.00~400Hz											
	Carrier Frequency	2~ 15kHz						2~ 9kHz			2~ 6kHz		
	Rated Output Maximum Carrier Frequency	8kHz	10kHz			8kHz			6kHz				
Input Rating	Rated Input Current(A)	11.5	14	17	24	30	37	47	58	80	100	128	165
	Rated voltage	3-phase 380~480V · 50/60Hz											
	Voltage Tolerance	±10% (342~528V)											
	Frequency Tolerance	±5% (47~63Hz)											
Cooling Method	Fan cooled												
Weight (kg)	6	8	10	10	10	10	13	14.5	36	36	50	50	

*Assumes operation at the rated output. Input current rating varies depending on the power supply, input reactor, wiring connections and power supply impedance.

General Specifications

Control Characteristics	Control Method	1: V/F, 2: VF+PG, 3: SVC, 4: FOC+PG, 5: TQC+PG, 6:FOC+PM
	Starting Torque	Reach up to 150% or above at 0.5 Hz Under FOC+PG or FOC+PM mode, starting torque can reach 150% at 0 Hz.
	Speed Control Range	1:100 (up to 1:1000 when using PG card)
	Speed Control Resolution	±0.5% (up to ±0.02% when using PG card)
	Speed Response Ability	5Hz (Up to 30Hz for vector control)
	Max. Output Frequency	0.00 to 400Hz
	Output Frequency Accuracy	Digital Command 0.005%, Analog Command 0.5%
	Frequency Setting Resolution	Digital Command 0.01Hz, Analog Command: 1/4096(12 bit) of the max. output frequency.
	Torque limit	Max. is 200% torque current
	Torque Accuracy	±5%
	Accel. / Decel. Time	0.00~600.00 seconds
	V/F Curve	Adjustable V/f curve using 4 independent points and square curve.
	Frequency Setting Signal	±10V
	Brake Torque	About 20%
	Protection Characteristics	Motor Protection
Over-current Protection		The current forces 190% of the over-current protection and 250% of the rated current.
Ground Leakage Current Protection		Higher than 50% rated current
Overload Ability		Constant torque: 150% for 60 seconds, variable torque: 190% for 5 seconds
Over-voltage Protection		Over-voltage level: Vdc > 400/800V; low-voltage level: Vdc < 200/400V
Over-voltage Protection for the Input Power		Varistor (MOV)
Over-temperature Protection		Built-in temperature sensor
Certifications	  (UL mark excludes VFD022ED21S and VFD037ED21S) EN81-1+A3, EN81-20	

Environment for Operation, Storage and Transportation

DO NOT expose the AC motor drive in a bad environment, such as dust, direct sunlight, corrosive/inflammable gasses, humidity, liquid and vibration environment. The salt in the air must be less than 0.01mg/cm² every year.

Environment	Installation location	IEC60364-1/IEC60664-1 Pollution degree 2, Indoor use only		
	Surrounding Temperature	Operation	Between 10°C ~40°C with Derating the operation temperature can reach 50°C	
			Between 40°C ~50°C with Derating	2.2-4kW: for every 1°C raise in temperature, decrease 2.2% of rated current
				5.5-30kW: for every 1°C raise in temperature, decrease 2.5% of rated current
			37-75kW: for every 1°C raise in temperature, decrease 2.0% of rated current	
		Storage and Transportation	-20 °C ~ +60 °C	
		Non-condensation, non-frozen		
	Rated Humidity	Operation	Max. 90%	
		Storage/ Transportation	Max. 90%	
		No condense water		
Altitude	Operation	If AC motor drive is installed at altitude 0~1000m, follow normal operation restriction. If it is install at altitude 1000~3000m, decrease 1% of rated current or lower 0.5°C of temperature for every 100m increase in altitude. Maximum altitude for Corner Grounded is 3000m. If an installation at an altitude higher than 3000m is required, contact Delta for more information.		
Power System	TN system ^{*1*2}			
Package Drop	Storage	ISTA procedure 1A (according to weight) IEC60068-2-31		
	Transportation			
Vibration	<ul style="list-style-type: none"> ● 1.0mm, peak to peak value range from 2Hz to 13.2 Hz; ● 0.7G~1.0G range from 13.2Hz to 55Hz; ● 1.0G range from 55Hz to 512 Hz. Comply with IEC 60068-2-27 			
Impact	IEC/EN 60068-2-27			
Protection Level	NEMA 1/IP20			

*1: TN system: The neutral point of the power system connects to the ground directly. The exposed metal components connect to the ground via the protective earth conductor.

*2: Single phase models use single phase three wire power system.





09 Digital Keypad

9-1 Description of Digital Keypad



Digital Operation Panel KPED-LE01











Function of Buttons

Buttons	Description
	Horizontal movement button: To move the cursor position for value adjustment.
	Reset the the motor drive after fault occurred.
	Change between different diplay mode.
	Parameter setting button: To read or modify various parameter settings.
	<ol style="list-style-type: none"> Two buttons available: Up and Down button Press Up or Down button to increase or decrease the value of a number. Press Up or Down button to choose between menus and languages.

LED Display

LED	Description
	Status Display: UP: Moving up. DN: Moving down D1: MI1 status D2: MI2 status D3: MI3 status D4: MI4 status
	Main Display Area: To display frequency, current, voltage, rotaion direction, user defined units, errors and warnings.

Description of the Displayed Functions

Displayed Function	Description
	Display the frequency setting of the VFD-ED
	Display the actual frequency delivered from VFD-ED to the motor.
	Display the user defined value at Pr00-04.
	Display the current (ampere)
	Display the selected parameter
	Display the value set at a parameter
	Display the external fault
	Display "End" for approximately 1 second if input has been accepted by pressing ENTER key. After a parameter value has been set, the new value is automatically stored in the register. To modify an entry, use the ▲ and ▼ keys.
	If the command given by the user is not accepted or the value of the command exceeds the allowed range, this error message will be displayed.

9-2 Operating the Built-in Digital Keypad

Setting Mode

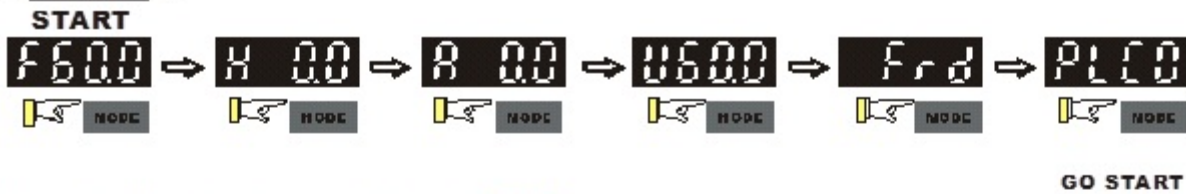

NOTE: In the selected mode, press **ENTER** to set the parameters.

Setting parameters



NOTE :In the parameter setting mode, you can press **ENTER** to the selected mode.

To change data



Setting direction (When operation source is digital keypad)



9-3 Description of the Digital Keypad KPC-CC01

KPC-CC01









Communication Interface
RJ-45 (socket), -485 interface;



Installation Method

1. Embedded type and can be put flat on the surface of the control box. The front cover is water proof.
2. Buy a MKC-KPPK model to do wall mounting or embedded mounting. Its protection level is IP66.
3. The maximum RJ45 extension lead is 5 m (16ft)
4. This keypad can also be used on Delta's motor drive C2000, CH2000 and CP2000.

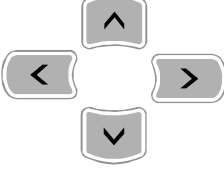
Function of Buttons

Button	Description
	<p>Start Operation Key</p> <ol style="list-style-type: none"> 1. It is only valid when the source of operation command is from the keypad. 2. It can operate the AC motor drive by the function setting and the RUN LED will be ON. 3. It can be pressed repeatedly while the motor drive is shutting down..
	<p>Stop Command Key. This key has the highest processing priority in any situation.</p> <ol style="list-style-type: none"> 1. When it receives STOP command, no matter the AC motor drive is in operation or stop status, the AC motor drive needs to execute "STOP" command. 2. The RESET key can be used to reset the drive after the fault occurs. For those faults that can't be reset by the RESET key, see the fault records after pressing MENU key for details.
	<p>Operation Direction Key</p> <ol style="list-style-type: none"> 1. This key is only control the operation direction NOT for activate the drive. FWD: forward, REV: reverse. 2. Refer to the LED descriptions for more details.
	<p>ENTER Key Press ENTER and go to the next level. If it is the last level then press ENTER to execute the command</p>
	<p>ESCAPE Key ESC key function is to leave current menu and return to the last menu. It is also functioned as a return key in the sub-menu.</p>
	<p>Press menu to return to main menu.</p>
	<p>Direction: Left/Right/Up/Down</p> <ol style="list-style-type: none"> 1. In the numeric value setting mode, it is used to move the cursor and change the numeric value. 2. In the menu/text selection mode, it is used for item selection.

Description of LED Functions

LED	Description
	<p>Steady ON: operation indicator of the AC motor drive, including DC brake, zero speed, standby, restart after fault and speed search.</p> <p>Blinking: drive is decelerating to stop or in the status of base block.</p> <p>Steady OFF: drive doesn't execute the operation command</p>
	<p>Steady ON: stop indicator of the AC motor drive.</p> <p>Blinking: drive is in the standby status.</p> <p>Steady OFF: drive doesn't execute "STOP" command.</p>
	<p>Operation Direction LED</p> <ol style="list-style-type: none"> 1. Green light is on, the drive is running forward. 2. Red light is on, the drive is running backward. 3. Twinkling light: the drive is changing direction.

9-4 Function of Digital Keypad KPC-CC01

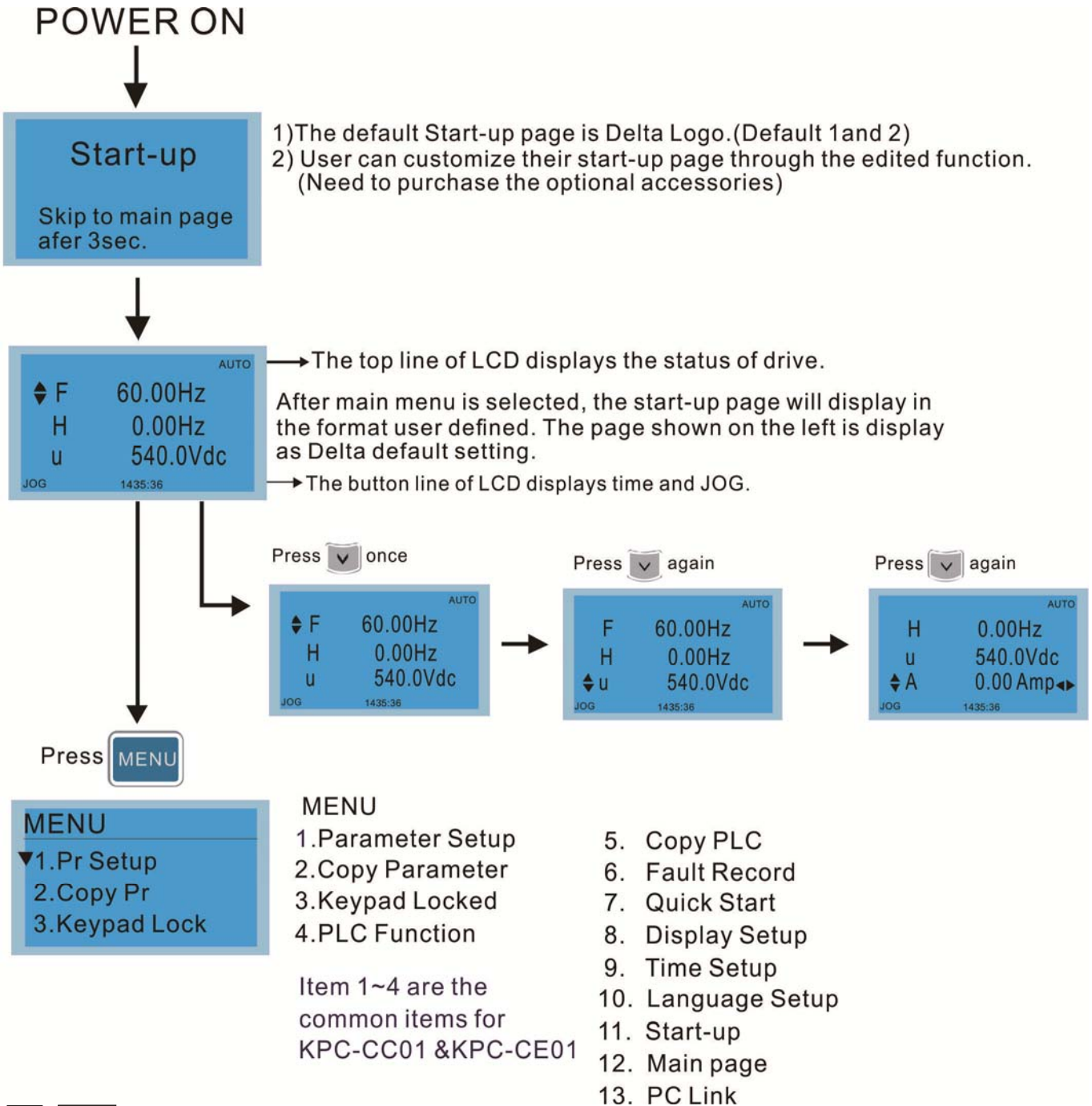

NOTE

1. Startup page can only display pictures, no flash.
2. When Power ON, it will display startup page then the main page. The main page displays Delta's default setting F/H/A/U, the display order can be set by Pr.00.03 (Startup display). When the selected item is U page, use left key and right key to switch between the items, the display order of U page is set by Pr.00.04 (User display).
3. **VFD-ED doesn't support Function 3, 4 and 5.**

Display Icon

Start-up

- ◆ 1.Default 1 ●
- 2.Default 2
- 3.User define

● : present setting

◆ : roll down the page for more options



Press  for more options.



Pr setup

- ◆ 00:SYSTEM PARAM
- 01:BASIC PARAM
- 02:DIGITAL IN/ ▶

▶ : show complete sentence

Press   for complete information

Display Item

MENU



- ◆ 1.Pr Setup
- 2.Copy Pr
- 3.Keypad Lock

MENU

- 1.Parameter Setup
- 2.Copy Parameter
- 3.Keypad Locked
- 4.PLC Function
- 5. Copy PLC
- 6. Fault Record
- 7. Quick Start
- 8. Display Setup
- 9. Time Setup
- 10. Language Setup
- 11. Start-up
- 12. Main page
- 13. PC Link

Item 1~4 are the common items for KPC-CC01 &KPC-CE01

1. Parameter Setup









<div style="border: 1px solid black; padding: 5px; background-color: #e0f0ff; margin-bottom: 10px;"> <p>Pr setup</p> <ul style="list-style-type: none"> ◆ 00:SYSTEM PARAM 01:BASIC PARAM 02:DIGITAL IN/ ▶ </div> <p>Press  to select.</p> <p>Press  to select a parameter group.</p> <p>Once a parameter group is selected, press  to go into that group.</p>	<p>For example: Setup source of master frequency command.</p> <div style="border: 1px solid black; padding: 5px; background-color: #e0f0ff; margin-bottom: 5px;"> <p>00- SYSTEM PARAME</p> <ul style="list-style-type: none"> ◆ 00: Identity Co ▶ 01: Rated Curren 02: Parameter Re </div> <p>Once in the Group 00 Motor Drive Parameter, Use Up/Down key to select parameter 20: Auto Frequency Command.</p> <div style="border: 1px solid black; padding: 5px; background-color: #e0f0ff; margin-bottom: 5px;"> <p>00- SYSTEM PARAME</p> <ul style="list-style-type: none"> ◆ 20: Source of F ▶ 21: Source of OP 22: Stop Methods </div> <p>When this parameter is selected, press ENTER key to go to this parameter's setting menu.</p> <div style="border: 1px solid black; padding: 5px; background-color: #e0f0ff; margin-bottom: 5px;"> <p>00-20</p> <p style="text-align: center;">2</p> <p>Analog Input</p> <p>0~8 ADD</p> </div> <p>Use Up/Down key to choose a setting. For example: Choose "2 Analogue Input, then press the ENTER key.</p> <div style="border: 1px solid black; padding: 5px; background-color: #e0f0ff;"> <p>00-20</p> <p style="text-align: center;">END</p> <p>Analog Input</p> </div> <p>After pressing the ENTER key, an END will be displayed which means that the parameter setting is done.</p>
--	---

2. Copy Parameter

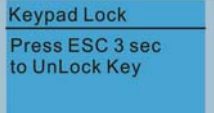

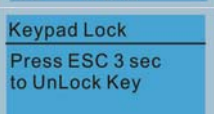

	<p>4 duplicates are provided The steps are shown in the example below. Example: Saved in the motor drive.</p>				
<p>Press ENTER key to go to 001~004: content storage</p>	<table border="1"> <tr> <td data-bbox="719 264 935 389"> </td> <td data-bbox="954 264 1492 383"> <p>1 Go to Copy Parameter 2 Select the parameter group which needs to be copied and press ENTER key.</p> </td> </tr> <tr> <td data-bbox="719 398 935 510"> </td> <td data-bbox="954 412 1500 510"> <p>1 Select 1: Save in the motor drive. 2. Press ENTER key to go to "Save in the motor drive" screen.</p> </td> </tr> </table>		<p>1 Go to Copy Parameter 2 Select the parameter group which needs to be copied and press ENTER key.</p>		<p>1 Select 1: Save in the motor drive. 2. Press ENTER key to go to "Save in the motor drive" screen.</p>
	<p>1 Go to Copy Parameter 2 Select the parameter group which needs to be copied and press ENTER key.</p>				
	<p>1 Select 1: Save in the motor drive. 2. Press ENTER key to go to "Save in the motor drive" screen.</p>				
	<table border="1"> <tr> <td data-bbox="719 533 935 651"> </td> <td data-bbox="954 591 1444 622"> <p>Begin to copy parameters until it is done.</p> </td> </tr> </table>		<p>Begin to copy parameters until it is done.</p>		
	<p>Begin to copy parameters until it is done.</p>				
	<table border="1"> <tr> <td data-bbox="719 667 935 763"> </td> <td data-bbox="954 689 1500 757"> <p>Once copying parameters is done, keypad will automatically be back to this screen.</p> </td> </tr> </table>		<p>Once copying parameters is done, keypad will automatically be back to this screen.</p>		
	<p>Once copying parameters is done, keypad will automatically be back to this screen.</p>				
	<p>Example: Saved in the keypad.</p> <table border="1"> <tr> <td data-bbox="719 846 935 965"> </td> <td data-bbox="954 853 1500 981"> <p>1. Once copying parameters is done, keypad will automatically be back to this screen. 2. Select the parameter group which needs to be copied and press ENTER key.</p> </td> </tr> </table>		<p>1. Once copying parameters is done, keypad will automatically be back to this screen. 2. Select the parameter group which needs to be copied and press ENTER key.</p>		
	<p>1. Once copying parameters is done, keypad will automatically be back to this screen. 2. Select the parameter group which needs to be copied and press ENTER key.</p>				
	<table border="1"> <tr> <td data-bbox="719 1003 935 1099"> </td> <td data-bbox="954 1025 1500 1093"> <p>Press ENTER key to go to "Save in the motor drive" screen.</p> </td> </tr> </table>		<p>Press ENTER key to go to "Save in the motor drive" screen.</p>		
	<p>Press ENTER key to go to "Save in the motor drive" screen.</p>				
	<table border="1"> <tr> <td data-bbox="719 1137 935 1256"> </td> <td data-bbox="954 1160 1500 1249"> <p>Use Up/Down key to select a symbol. Use Left/Right key to move the cursor to select a file name.</p> </td> </tr> </table>		<p>Use Up/Down key to select a symbol. Use Left/Right key to move the cursor to select a file name.</p>		
	<p>Use Up/Down key to select a symbol. Use Left/Right key to move the cursor to select a file name.</p>				
	<p>String & Symbol Table: !"#\$%&'()*+,-./0123456789:;<=>?@ABCDEFGHIJKLMN OPQRSTUVWXYZ [\]^_`abcdefghijklmnopqrstu vwxyz{ }~</p>				
	<table border="1"> <tr> <td data-bbox="719 1451 935 1547"> </td> <td data-bbox="954 1480 1500 1547"> <p>Once the file name is confirmed, press ENTER key.</p> </td> </tr> </table>		<p>Once the file name is confirmed, press ENTER key.</p>		
	<p>Once the file name is confirmed, press ENTER key.</p>				
	<table border="1"> <tr> <td data-bbox="719 1585 935 1704"> </td> <td data-bbox="954 1637 1484 1668"> <p>To begin copying parameters until it is done.</p> </td> </tr> </table>		<p>To begin copying parameters until it is done.</p>		
	<p>To begin copying parameters until it is done.</p>				
	<table border="1"> <tr> <td data-bbox="719 1742 935 1839"> </td> <td data-bbox="954 1749 1500 1839"> <p>When copying parameters is completed, keypad will automatically be back to this screen.</p> </td> </tr> </table>		<p>When copying parameters is completed, keypad will automatically be back to this screen.</p>		
	<p>When copying parameters is completed, keypad will automatically be back to this screen.</p>				
	<table border="1"> <tr> <td data-bbox="719 1877 935 1995"> </td> <td data-bbox="954 1906 1500 1973"> <p>Press Right key to see the date of copying parameters.</p> </td> </tr> </table>		<p>Press Right key to see the date of copying parameters.</p>		
	<p>Press Right key to see the date of copying parameters.</p>				

	<p>Copy pr</p> <p>◆ 001:18:38:58 ◀</p> <p>002:</p> <p>003:</p>	<p>Press Right key to see the time of copying parameters.</p>
--	--	---

3. Lock the Keypad

<p>Keypad Lock Press ENTER to Lock Key</p>	<p>Keypad Locked</p> <p>This function is used to lock the keypad. The main page would not display "keypad locked" when the keypad is locked, however it will display the message "please press ESC and then ENTER to unlock the keypad" when any key is pressed.</p>
<p>Press  to lock</p>	<p> When the keypad is locked, the main screen doesn't display any status to show that.</p>
<p>Press  to lock</p>	<p> Press any key on the keypad; a screen as shown in image on the left will be displayed.</p>
<p>Press  to lock</p>	<p> If ESC key is not pressed, the keypad will automatically be back to this screen.</p>
<p>Press  to lock</p>	<p> The keypad is still locked at this moment. By pressing any key, a screen as shown in the image on the left will still be displayed.</p>
<p>Press  to lock</p>	<p> Press ESC for 3 seconds to unlock the keypad and the keypad will be back to this screen. Then each key on the keypad is functional.</p>
	<p>Turn off the power and turn on the power again will not lock keypad.</p>

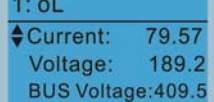
4. Fault Record



<p>Fault record ▼ 1:oL 2:ovd 3:GFF</p>	<p>Able to store 6 error code (Keypad V1.02 and previous versions) Able to store 20 error code(Keypad V1.0e3 and previous version) The most recent error record is shown as the first record. Select an error record to see its detail such as date, tme, frequency, current, voltage, DCBUS voltage)</p>
<p>Press  to select.</p>	<p> Press Up/Down key to select an error record. After selecting an error code, press ENTER to see that error record's detail</p>
<p>KPC-CE01 does not support this function.</p>	<p> Press Up/Down key to see an error record's detail such as date, time, frequency, current, voltage, DCBus voltage.</p>
	<p> Press Up/Down key to select an error record. After selecting an error code, press ENTER to see that error record's detail</p>
	<p> Press Up/Down key to see an error record's detail such as date, time, frequency, current, voltage, DCBus voltage.</p>

	<p>2: ovd ◆ Date: 01/20/2014 Time: 21:02:24 Outfreq: 32.61</p> <p> NOTE</p> <p>Fault actions of AC motor drive are record and save to KPC-CC01. When KPC-CC01 is removed and apply to another AC motor drive, the previous fault records will not be deleted. The new fault records of the present AC motor drive will accumulate to KPC-CC01.</p>
--	---

5. Display Setup

<p>Displ Setup ▼1: Contrast 2: Back-Light 3: Text Color</p> <p>Press  to setting menu.</p>	<p>1. Contrast</p> <div style="border: 1px solid black; padding: 2px; margin-bottom: 5px;"> <p>Contrast</p> <p style="text-align: center;">+0</p> <div style="border: 1px solid black; width: 100%; height: 10px; position: relative;"> <div style="background-color: black; width: 50%;"></div> </div> <p style="text-align: center;">-20 +20</p> </div> <p>Use Up/Down key to adjust the setting value.</p> <div style="border: 1px solid black; padding: 2px; margin-bottom: 5px;"> <p>Contrast</p> <p style="text-align: center;">+10</p> <div style="border: 1px solid black; width: 100%; height: 10px; position: relative;"> <div style="background-color: black; width: 75%;"></div> </div> <p style="text-align: center;">-20 +20</p> </div> <p>After selecting a setting value. Press ENTER to see screen's display after contrast is adjusted to be +10.</p> <div style="border: 1px solid black; padding: 2px; margin-bottom: 5px;"> <p>Displ Setup</p> <p>▼1: Contrast 2: Back-Light 3: Text Color</p> </div> <p>When the setting value is 0 Min, the back light will be steady on.</p> <div style="border: 1px solid black; padding: 2px; margin-bottom: 5px;"> <p>Contrast</p> <p style="text-align: center;">-10</p> <div style="border: 1px solid black; width: 100%; height: 10px; position: relative;"> <div style="background-color: black; width: 25%;"></div> </div> <p style="text-align: center;">-20 +20</p> </div> <p>Then press ENTER.</p> <div style="border: 1px solid black; padding: 2px; margin-bottom: 5px;"> <p>Displ Setup</p> <p>▼1: Contrast 2: Back-Light 3: Text Color</p> </div> <p>After select a setting value Press ENTER to see screen's display result after contrast is adjusted to be -10.</p> <p>2. Back-light</p> <div style="border: 1px solid black; padding: 2px; margin-bottom: 5px;"> <p>Displ Setup</p> <p>1: Contrast ◆2: Back-Light 3: Text Color</p> </div> <p>Press ENTER to go to Back Light Time Setting screnn.</p> <div style="border: 1px solid black; padding: 2px; margin-bottom: 5px;"> <p>Back-Light Min</p> <p style="text-align: center;">5</p> <div style="border: 1px solid black; width: 100%; height: 10px; position: relative;"> <div style="background-color: black; width: 50%;"></div> </div> <p style="text-align: center;">0 10</p> </div> <p>Use Up/Down key to adjust the setting value.</p> <div style="border: 1px solid black; padding: 2px; margin-bottom: 5px;"> <p>Back-Light Min</p> <p style="text-align: center;">0</p> <div style="border: 1px solid black; width: 100%; height: 10px; position: relative;"> <div style="background-color: black; width: 0%;"></div> </div> <p style="text-align: center;">0 10</p> </div> <p>When the setting value is 0 Min, the back light will be steady on.</p> <div style="border: 1px solid black; padding: 2px; margin-bottom: 5px;"> <p>Displ Setup</p> <p>1: Contrast ◆2: Back-Light 3: Text Color</p> </div> <p>When the setting value is 10 Min, the backlight will be off in 10 minutes.</p>
---	--

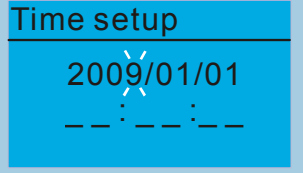
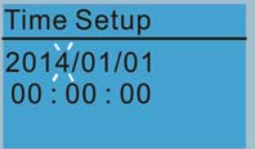
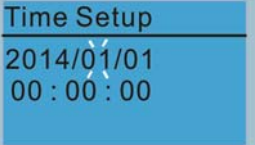
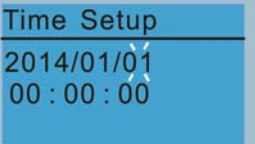
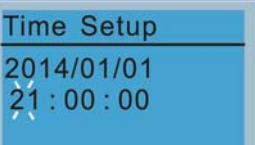
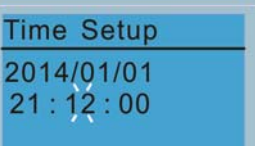
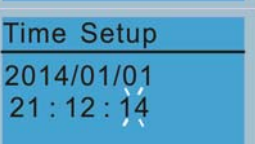
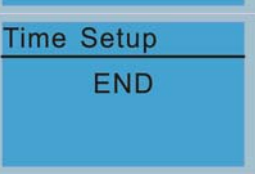

6. Time Setting

 <p>Use Left/Right key to select Year, Month, Day, Hour, Minute or Second to set up</p>		Use Up/Down key to set up Year
		Use Up/Down key to set up Month
		Use Up/Down key to set up day
		Use Up/Down key to set up hour
		Use Up/Down key to set up Minute
		Use Up/Down key to set up Second
		After setting up, press ENTER to confirm the setup.
	<p> NOTE</p> <p>When the digital keypad is removed, the time setting will be in standby status for 7 days. After this period, the time needs to be reset.</p>	

7. Language setup

 <p>Use Up/Down key to select language, than press ENTER.</p>	<p>Language setting option is displayed in the language of the user's choice. Language setting options:</p> <table border="0"> <tr> <td>1. English</td> <td>5.</td> </tr> <tr> <td>2. 繁體中文</td> <td>6. Espanol</td> </tr> <tr> <td>3. 简体中文</td> <td>7. Portugues</td> </tr> <tr> <td>4. Turkce</td> <td></td> </tr> </table>	1. English	5.	2. 繁體中文	6. Espanol	3. 简体中文	7. Portugues	4. Turkce	
1. English	5.								
2. 繁體中文	6. Espanol								
3. 简体中文	7. Portugues								
4. Turkce									

8. Startup

<p>Start-up</p> <ul style="list-style-type: none"> ▼ 1.Default 1 ● 2.Default 2 3.User Define 	<p>1. Default 1 DELTA LOGO</p>  <p>2. Default 2 DELTA Text</p>  <p>3. User Defined: optional accessory is require (TPEditor & USB/RS-485 Communication Interface-IFD6530)</p> <p>Install an editing accessory would allow users to design their own start-up page.If editor accessory is not installed, “user defined” option will display a blank page.</p>  <p><u>USB/RS-485 Communication Interface-IFD6530</u> Please refer to Chapter 07 Optional Accessories for more detail.</p> <p><u>TPEditor</u> Go to Delta’s website to download TPEditor V1.30.6 or later versions. http://www.delta.com.tw/ch/product/em/download/download_main.asp?act=3&pid=1&cid=1&tpid=3</p>
--	--

9. Mian Pge

Main Page

- ▼ 1.Default ●
- 2.User Define

Default picture and editable picture are available upon selection.

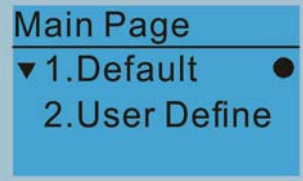
Press  to select.

1. Default page



F 600.00Hz >>> H >>> A >>> U (circulate)

2. User Defined: optional accessory is require (TPEditor & USB/RS-485 Communication Interface-IFD6530)
Install an editing accessory would allow users to design their own start-up page.If editor accessory is not installed, "user defined" option will dispay a blank page.

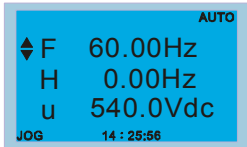
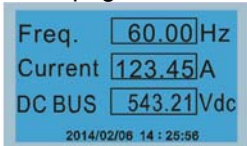
USB/RS-485 Communication Interface-IFD6530
Please refer to Chapter 07 Optional Acessories for more detail.

TPEditor
Go to Delta's website to download TPEditor V1.30.6 or later versions.
http://www.delta.com.tw/ch/product/em/download/download_main.asp?act=3&pid=1&cid=1&tpid=3

10. PC Link

PC Link

- ▼ 1. TPEditor
- 2. VFDSOft

1. TPEditor: This function allows users to connect the keypad to a computer then to download and edit user defined pages.

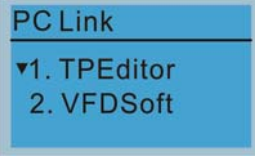

Click ENTER to go to <Waiting to connect to PC>

In TPEditor, choose <Communication>, then choose "Write to HMI"

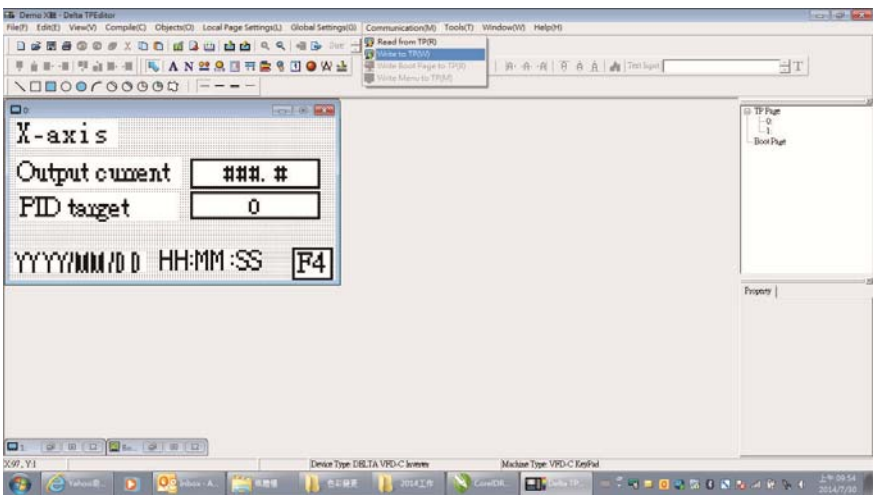

Choose <YES> in the <Confirm to Write> dialogue box.

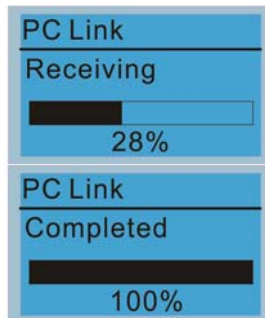
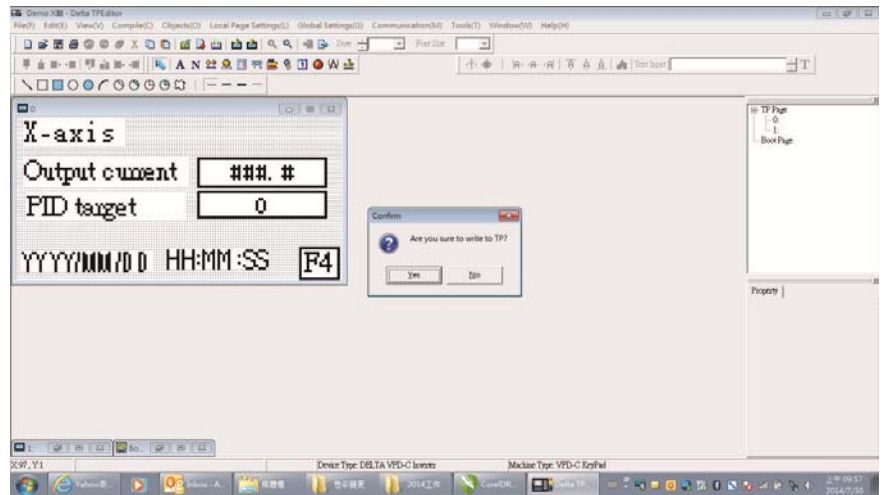

Start downloading pages to edit KPC-CC01.

Download completed

2. VFDSOft: this function allows user to link to the VFDSOft Operating software then to upload data
Copy parameter 1~4 in KPC-CC01
Connect KPC-CC01 to a computer

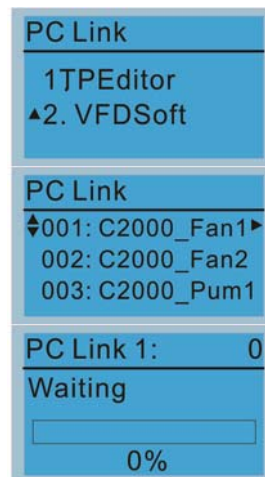

Start downloading pages to edit to KPC-CC01

Use Up/Down key to select a parameter group to upload to VFDSOft. Press ENTER

Waiting to connect to PC

Open VFDSOft, choose <Parameter Manager function>

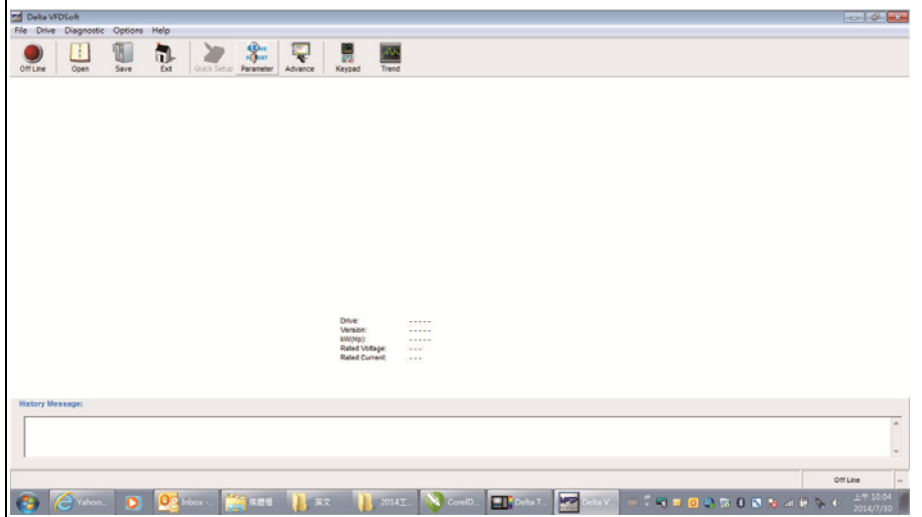

In Parameter Manager, choose <Load parameter table from KPC-CC01>

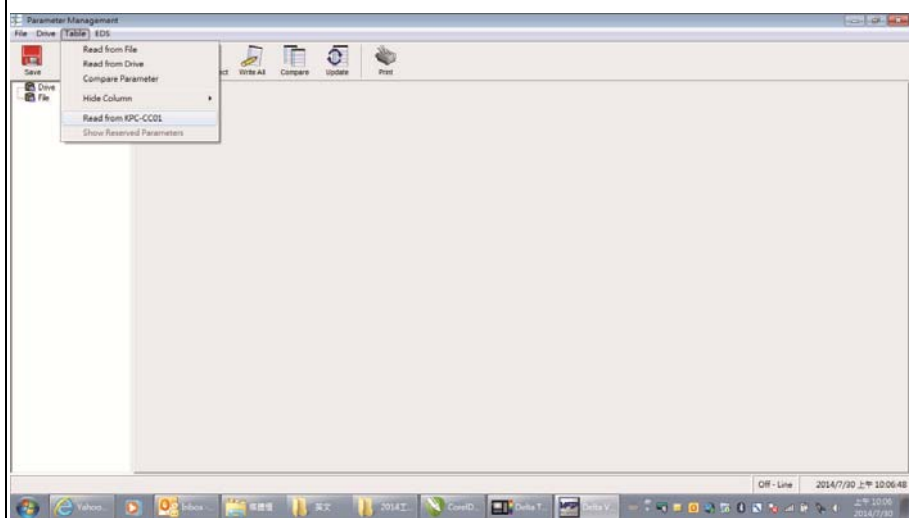

Choose the right communication port and click OK

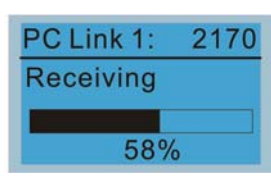
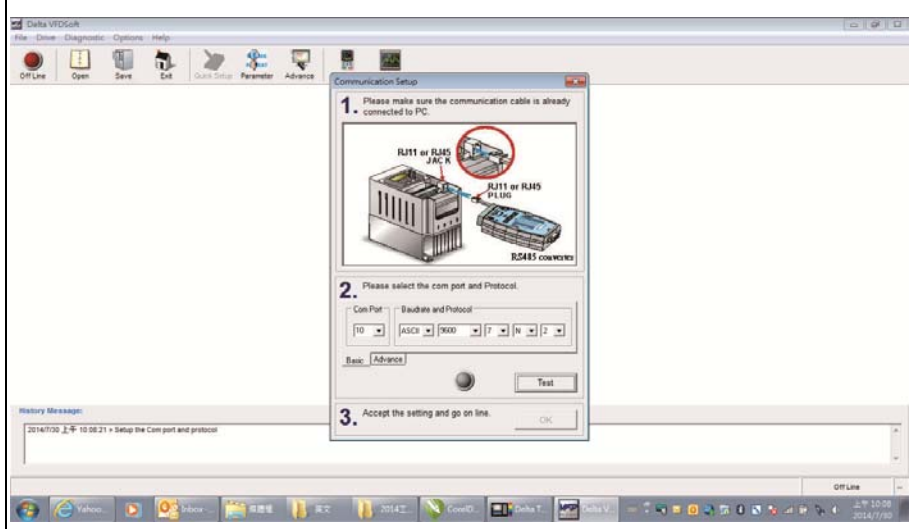

Start to upload parameters to VFDSOft

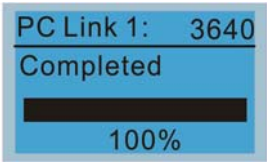
	 <p>Uploading parameter is completed</p> <p>Before using the user defined starting screen and user defined main screen, the starting screen setup and the main screen setup have to be preset as user defined.</p> <p>If the user defined page are not downloaded to KPC-CC01, the starting screen and the main screen will be blank.</p>
--	--

Other Display

When fault occur, the menu will display:

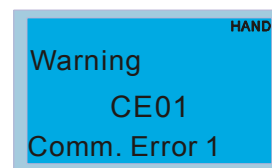
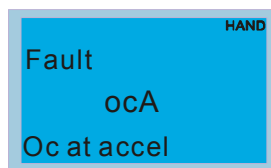

1. Press ENTER and start RESET. If still no response, please contact local distributor or return to the factory. To view the fault DC BUS voltage, output current and output voltage, press "MENU"→"Fault Record".
2. Press ENTER again, if the screen returns to main page, the fault is clear.
3. When fault or warning message appears, backlight LED will blinks until the fault or the warning is cleared.

Optional accessory: RJ45 Extension Lead for Digital Keypad

Part No.	Description
CBC-K3FT	RJ45 extension lead, 3 feet (approximately 0.9m)
CBC-K5FT	RJ45 extension lead, 5 feet (approximately 1.5 m)
CBC-K7FT	RJ45 extension lead, 7 feet (approximately 2.1 m)
CBC-K10FT	RJ45 extension lead, 10 feet (approximately 3 m)
CBC-K16FT	RJ45 extension lead, 16 feet (approximately 4.9 m)

Note: When you need to buy communication cables, buy non-shielded , 24 AWG, 4 twisted pair, 100 ohms communication cables.

9-5 Digital Keypad KPC-CC01 Fault Codes and Descriptions

Fault Codes:

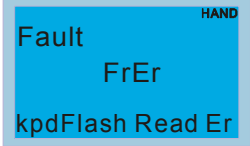
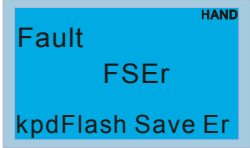
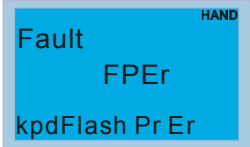
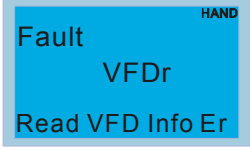
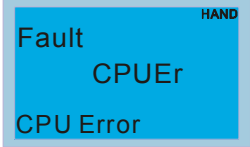
LCM Display *	Description	Corrective Actions
	Keypad flash memory read error	<p>An error has occurred on keypad's flash memory.</p> <ol style="list-style-type: none"> 1. Press RESET on the keypad to clear errors. 2. Verify what kind of error has occurred on keypad's flash memory. 3. Shut down the system, wait for ten minutes, and then power on again the system. <p>If none of the solution above works, contact your authorized local dealer.</p>
	Keypad flash memory save error	<p>An error has occurred on keypad's flash memory.</p> <ol style="list-style-type: none"> 1. Press RESET on the keypad to clear errors. 2. Press RESET on the keypad to clear errors. 3. Shut down the system, wait for ten minutes, and then power on again the system. <p>If none of the solution above works, contact your authorized local dealer.</p>
	Keypad flash memory parameter error	<p>Errors occurred on parameters of factory setting. It might be caused by firmware update.</p> <ol style="list-style-type: none"> 1. Press RESET on the keypad to clear errors. 2. Verify if there's any problem on Flash IC. 3. Shut down the system, wait for ten minutes, and then power on again the system. <p>If none of the solution above works, contact your local authorized dealer.</p>
	Keypad flash memory read AC drive data error	<p>Keypad can't read any data sent from VFD.</p> <ol style="list-style-type: none"> 1. Verify if the keypad is properly connect to the motor drive by a communication cable such as RJ-45. 2. Press RESET on the keypad to clear errors. 3. Shut down the system, wait for ten minutes, and then power on again the system. <p>If none of the solution above works, contact your local authorized dealer.</p>
	and then power on again the system.	<p>A Serious error has occurred on keypad's CPU.</p> <ol style="list-style-type: none"> 1. Verify if there's any problems on CPU clock? 2. Verify if there's any problem on Flash IC? 3. Verify if there's any problem on RTC IC? 4. Verify if the communication quality of the RS485 is good? 5. Shut down the system, wait for ten minutes, and then power on again the system. If none of the solution above works, contact your local authorized dealer.

Warning Codes:

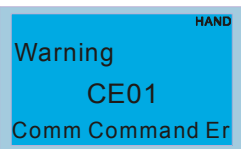
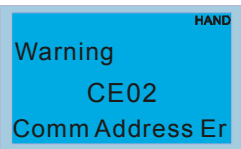
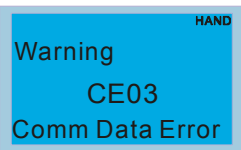
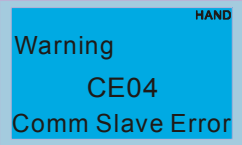
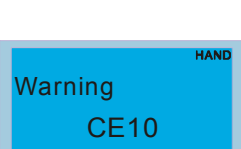
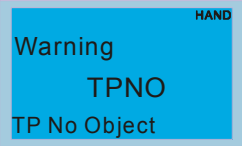
LCM Display *	Description	Corrective Actions
 <p>Warning CE01 Comm Command Er</p>	Modbus function code error	<p>Motor drive doesn't accept the communication command sent from keypad.</p> <ol style="list-style-type: none"> 1. Verify if the keypad is properly connected to the motor drive on the communication contact by a communication cable such as RJ-45. 2. Press RESET on the keypad to clear errors. <p>If none of the solution above works, contact your local authorized dealer.</p>
 <p>Warning CE02 Comm Address Er</p>	Modbus data address error	<p>Motor rive doesn't accept keypad's communication address.</p> <ol style="list-style-type: none"> 1. Verify if the keypad is properly connected to the motor drive on the communication contact by a communication cable such as RJ-45. 2. Press RESET on the keypad to clear errors. <p>If none of the solution above works, contact your local authorized dealer.</p>
 <p>Warning CE03 Comm Data Error</p>	Modbus data value error	<p>Motor drive doesn't accept the communication data sent from keypad.</p> <ol style="list-style-type: none"> 1. Verify if the keypad is properly connected to the motor drive on the communication contact by a communication cable such as RJ-45. 2. Press RESET on the keypad to clear errors. <p>If none of the solution above works, contact your local authorized dealer.</p>
 <p>Warning CE04 Comm Slave Error</p>	Modbus slave drive error	<p>Motor drive cannot process the communication command sent from keypad.</p> <ol style="list-style-type: none"> 1. Verify if the keypad is properly connected to the motor drive on the communication contact by a communication cable such as RJ-45. 2. Press RESET on the keypad to clear errors. 3. Shut down the system, wait for ten minutes, and then power on again the system. <p>If none of the solution above works, contact your local authorized dealer.</p>
 <p>Warning CE10 KpdComm Time Out</p>	Modbus transmission time-Out	<p>Motor drive doesn't respond to the communication command sent from keypad.</p> <ol style="list-style-type: none"> 1. Verify if the keypad is properly connected to the motor drive on the communication contact by a communication cable such as RJ-45. 2. Press RESET on the keypad to clear errors. 3. Shut down the system, wait for ten minutes, and then power on again the system. <p>If none of the solution above works, contact your local authorized dealer.</p>
 <p>Warning TPNO TP No Object</p>	Object not supported by TP Editor	<p>Keypad's TP Editor uses unsupported object.</p> <ol style="list-style-type: none"> 1. Verify how the TP editor should use that object. Delete unsupported object and unsupported setting. 2. Reedit the TP editor and then download it. <p>If none of the solution above works, contact your local authorized dealer.</p>

File Copy Setting Fault Description

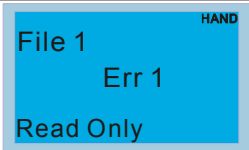
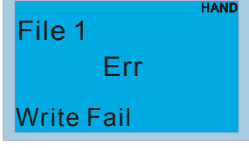
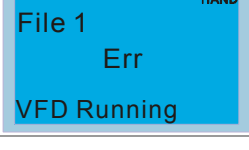
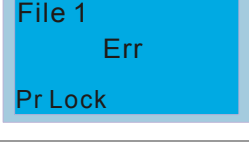
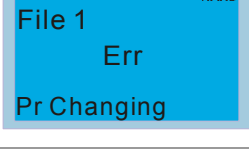
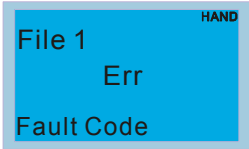
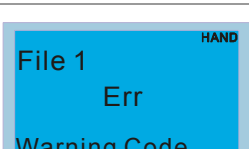
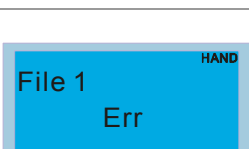
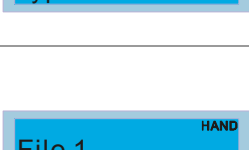
LCM Display *	Description	Corrective Actions
	Parameter and file are read only	The property of the parameter/file is read-only and cannot be written to. 1. Verify the specification on the user manual. If the solution above doesn't work, contact your local authorized dealer.
	Fail to write parameter and file	An error occurred while write to a parameter/file. 1. Verify if there's any problem on the Flash IC. 2. Shut down the system, wait for ten minutes, and then power on again the system. If none of the solution above work, contact your local authorized dealer.
	AC drive is in operating status	A setting cannot be made while motor drive is in operation. 1. Verify if the drive is not in operation. If the solution above doesn't work, contact your local authorized dealer.
	AC drive parameter is locked	A setting cannot be made because a parameter is locked. 1. Verify if the parameter is locked or not. If it is locked, unlock it and try to set up the parameter again. If the solution above doesn't work, contact your local authorized dealer.
	AC drive parameter changing	A setting cannot be made because a parameter is being modified. 1. Verify if the parameter is being modified. If it is not being modified, try to set up that parameter again. If the solution above doesn't work, contact your local authorized dealer.
	Fault code	A setting cannot be made because an error has occurred on the motor drive. 1. Verify if there's any error occurred on the motor drive. If there isn't any error, try to make the setting again. If the solution above doesn't work, contact your local authorized dealer.
	Warning code	A setting cannot be made because of a warning message given to the motor drive. 1. Verify if there's any warning message given to the motor drive. If the solution above doesn't work, contact your local authorized dealer.
	File type dismatch	Data need to be copied are not same type, so the setting cannot be made. 1. Verify if the products' serial numbers need to be copied fall in the category. If they are in the same category, try to make the setting again. If the solution above doesn't work, contact your authorized dealer.
	File is locked with password	A setting cannot be made, because some data are locked. 1. Verify if the data are unlocked or able to be unlocked. If the data are unlocked, try to make the setting again. 2. Shut down the system, wait for ten minutes, and then power on again the system. If none of the solution above works, contact your local authorized dealer.

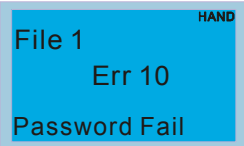
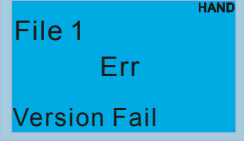
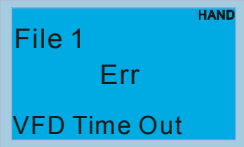
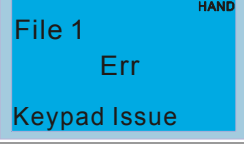
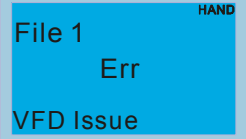
LCM Display *	Description	Corrective Actions
	File version mismatch	<p>A setting cannot be made because the password is incorrect.</p> <ol style="list-style-type: none"> 1. Verify if the password is correct. If the password is correct, try to make the setting again. 2. Shut down the system, wait for ten minutes, and then power on again the system. <p>If none of the solution above works, contact your local authorized dealer.</p>
	AC drive copy function time-out	<p>A setting cannot be made, because the version of the data is incorrect.</p> <ol style="list-style-type: none"> 1. Verify if the version of the data matches the motor drive. If it matches, try to make the setting again. <p>If none of the solution above works, contact your local authorized dealer.</p>
	Other keypad error	<p>A setting cannot be made, because data copying timeout expired.</p> <ol style="list-style-type: none"> 1. Redo data copying. 2. Verify if copying data is authorized. If it is authorized, try again to copy data. 3. Shut down the system, wait for ten minutes, and then power on again the system. <p>If none of the solution above works, contact your local authorized dealer.</p>
	Other AC drive error	<p>This setting cannot be made, due to other keypad issues. (Reserved functions)</p> <p>If such error occurred, contact your local authorized dealer.</p>
	File is locked with password	<p>This setting cannot be made, due to other motor drive issues. (Reserved functions).</p> <p>If such error occurred, contact your local authorized dealer.</p>

※ The content in this chapter only applies on V1.01 and above of KPC-CC01 keypad.

9-6 TPEditor Installation

TPEditor can edit up to 256 HMI (Human-Machine Interface) pages with a total storage capacity of 256kb. Each page can edit 50 normal objects and 10 communication objects.

1) TPEditor: Setup & Basic Functions

1. Run TPEditor version 1.60 or later.



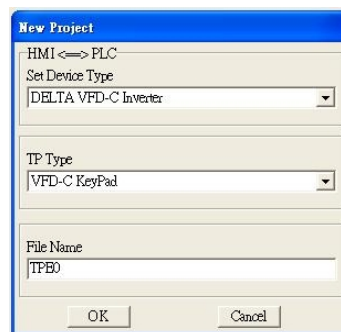

2. Go to File(F)→Click on New. The Window below will pop up. At the device type, click on the drop down menu and choose DELTA VFD-C Inverter. At the TP type, click on the drop down menu and choose VFD-C KeyPad. As for File Name, enter TPE0. Now click on OK.



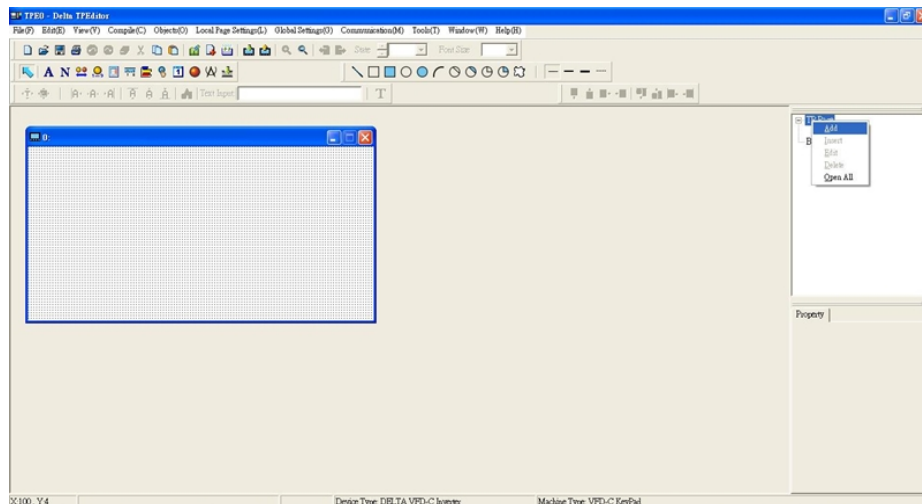

3. You are now at the designing page. Go to Edit (E)→Click on Add a New Page (A) or go to the TP page on the upper right side, right click once on TP page and choose Add to increase one more page for editing. The current firmware of Keypad is version1.00 and can support up to 4 pages.

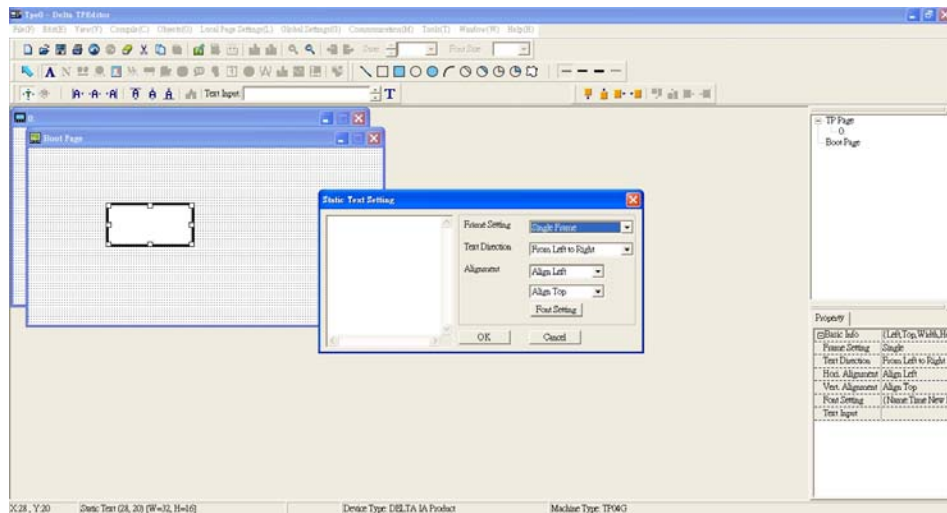

4. Edit Startup Page

5. Static Text  . Open a blank page, click once on this button  , and then double click on that blank page. The following windows will pop up.



6. Static Bitmap  → Open a blank page, then click once on this button  and then double click on that blank page. The following window will pop up.

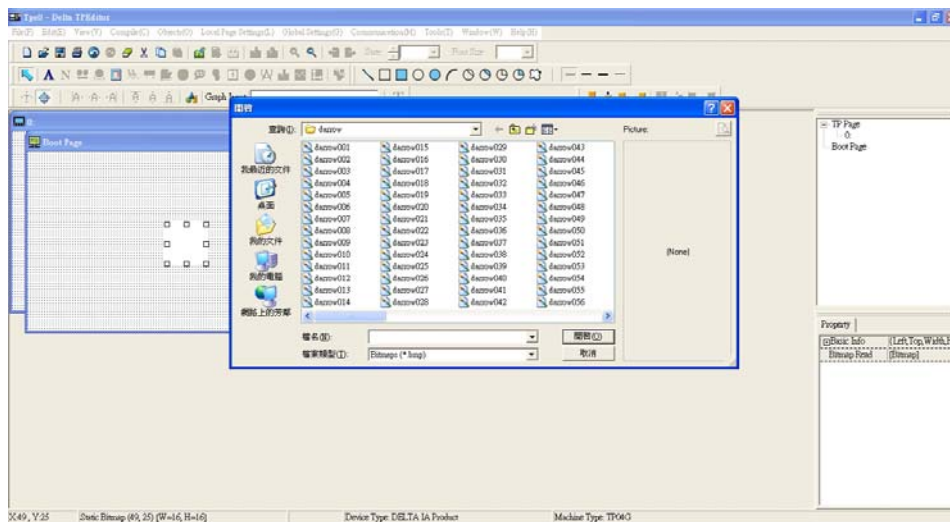

Please note that Static Bitmap setting support only images in BMP format. Now choose a image that you need and click open, then that image will appear in the Static Bitmap window.

7. Geometric Bitmap  → As shown in the picture on the left side, there are 11 kinds of geometric bitmap to choose. Open a new blank page then click once on a geometric bitmap icon that you need. Then drag that icon and enlarge it to the size that you need on that blank page.

8. Finish editing the keypad starting screen and select **Communication>Input User Defined Keypad Starting Screen**.

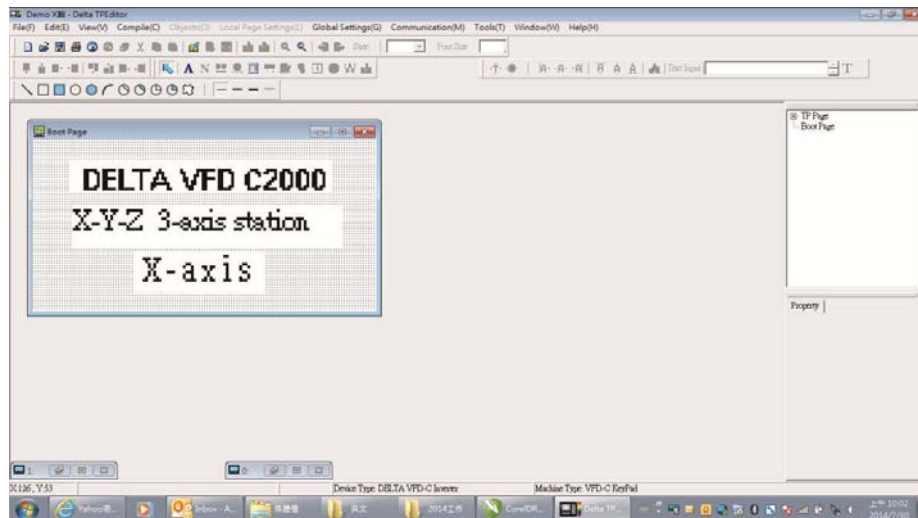

9. Downloading setting: Go to Tool > Communication. Set up communication port and speed of IFD6530.
10. Only three speed selections are available: 9600 bps, 19200 bps and 38400 bps.

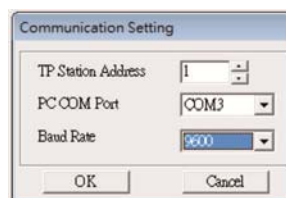

11. When a dialogue box displayed on the screen asking to confirm writing or not, press buttons on the keypad to go to MENU, select PC LINK and then press ENTER and wait for few seconds. Then select YES on the screen to start downloading.

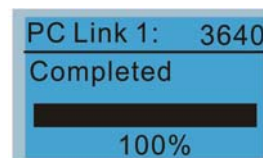
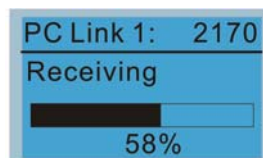
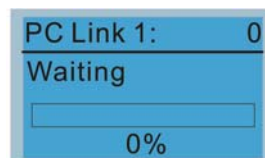
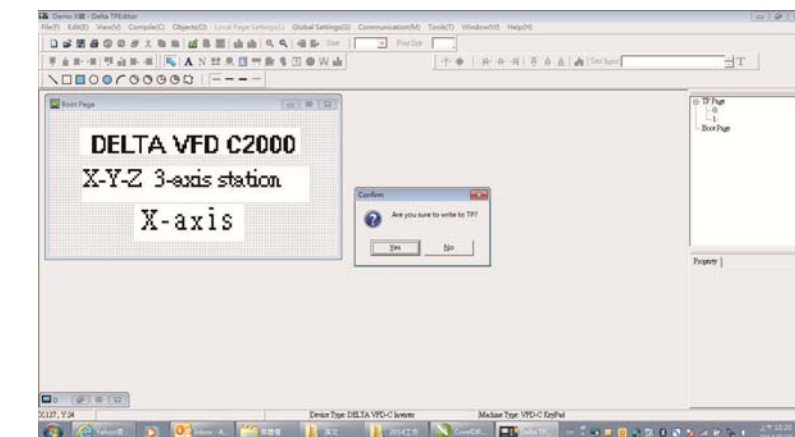

2) Edit Main Page & Example of Download

1. Go to editing page, select Edit→Add one page or press the button ADD on the right hand side of the HMI page to increase number of pages to edit. This keypad currently support up to 256 pages.

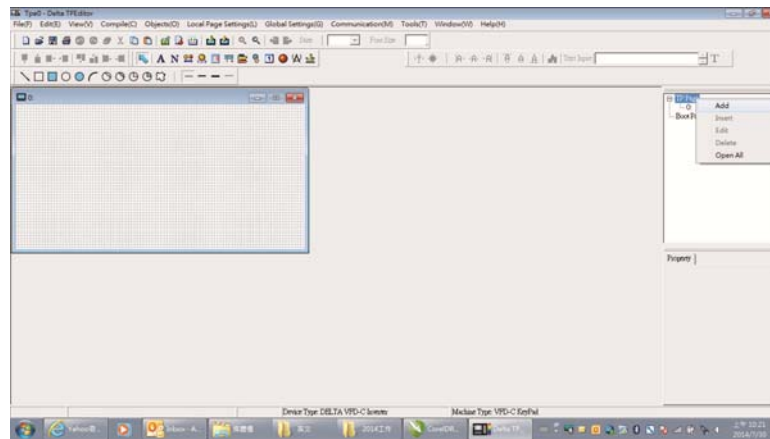

2. On the bottom right-hand corner of the HMI, click on a page number to edit or go to VIEW >HMI page to start editing main page. As shown in the image, the following objects are available. From left to right: Static Text, ASCII Display, Static Bitmap, Scale, Bar Graph, Button, Clock Display, Multi-state bit map, Units, Numeric Input and 11 geometric bitmaps and lines of different width. The application of Static Text, Static Bitmap, and geometric bitmap is the same as the editing startup page.



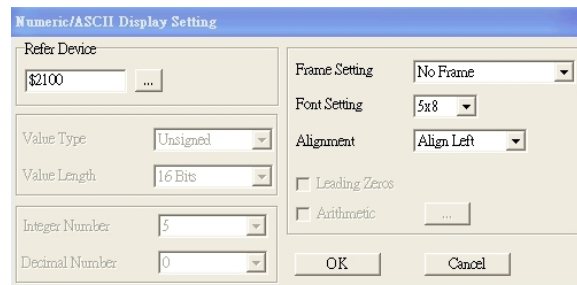

3. Numeric/ASCII Display : To add a Numeric/ASCII Display object to a screen, double click on the object to set up Related Devices, Frame Setting , Fonts and Alignment.



Related Device: Choose the VFD Communication Port that you need, if you want to read output frequency (H), set the VFD Communication Port to \$2202. For other values, please refer to ACMD ModBus Comm Address List.



4. Scale Setting  : On the Tool Bar, click on this  for Scale Setting. You can also edit Scale Setting in the Property Window on the right hand side of your computer screen.

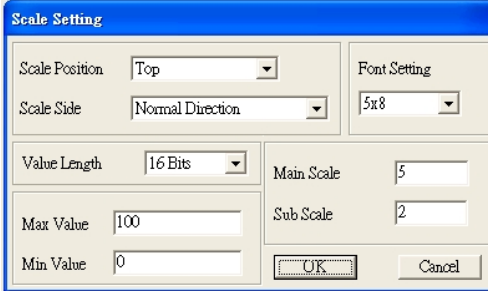

The Scale Setting dialog box contains the following fields and controls:

- Scale Position: Top (dropdown)
- Scale Side: Normal Direction (dropdown)
- Font Setting: 5x8 (dropdown)
- Value Length: 16 Bits (dropdown)
- Main Scale: 5 (text input)
- Sub Scale: 2 (text input)
- Max Value: 100 (text input)
- Min Value: 0 (text input)
- Buttons: OK, Cancel

- Scale Position: Click on the drop down list to choose which position that you need to place a scale.
 - Scale Side: Click on the drop down list to choose if you want to number your scale from smaller number to bigger number or from big to small. Click OK to accept this setting or click Cancel to abort.
 - Font Setting: Click on the drop down list to choose the Font setting that you need then click OK to accept the setting or click Cancel to abort.
 - Value Length: Click on the drop down to choose 16bits or 32 bits. Then click OK to accept the setting or click Cancel to abort.
 - Main Scale & Sub Scale: In order to divide the whole scale into equal parts, key in the numbers of your choices for main scale and sub scale.
 - Maximum value & Minimum Value are the numbers on the two ends of a scale. They can be negative numbers. But the values allowed to be input are limited by the length of value. For example, when the length of value is set to **be hexadecimal**, the maximum and the minimum value cannot be input as -4000.
- Follow the Scale setting mentioned above; you will have a scale as shown below.

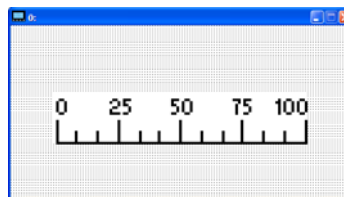

5. Bar Graph setting  :

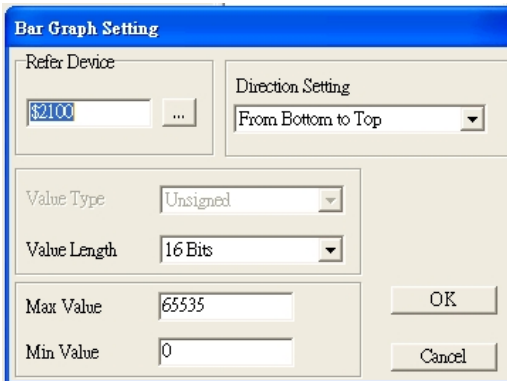

The Bar Graph Setting dialog box contains the following fields and controls:

- Refer Device: \$2100 (text input)
- Direction Setting: From Bottom to Top (dropdown)
- Value Type: Unsigned (dropdown)
- Value Length: 16 Bits (dropdown)
- Max Value: 65535 (text input)
- Min Value: 0 (text input)
- Buttons: OK, Cancel

- Related Device: Choose the VFD Communication Port that you need.
- Direction Setting: Click on the drop down menu to choose one of the following directions: From Bottom to Top, From Top to Bottom, From Left to Right or From Right to Left.
- Maximum Value & Minimum Value: They define the range covered by the maximum value and minimum value. If a value is smaller than or equal to the minimum value, then the bar graph will be blank. If a value is bigger or equal to the maximum value, then the bar graph will be full. If a value is between minimum and maximum value, then the bar graph will be filled proportionally.

6. Button  : Currently this function only allows the Keypad to switch pages, other functions are not yet available. Text input function and Image inserted functions are not yet supported.

Double click on  to open set up window.

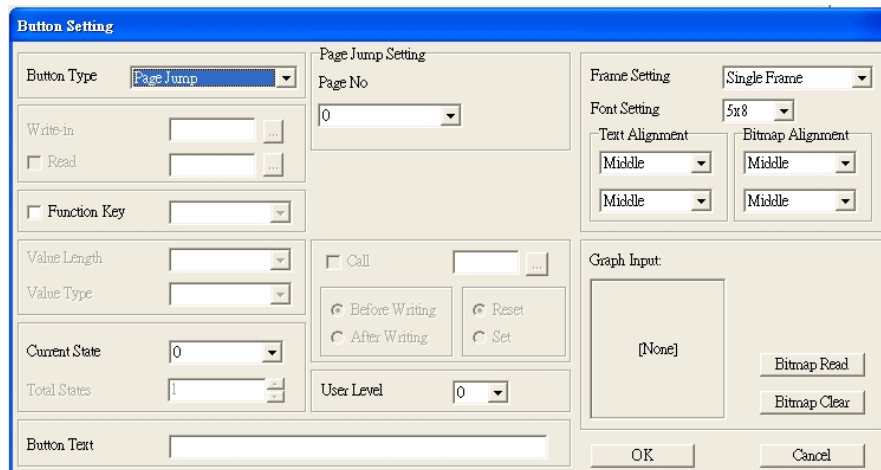

<Button Type> allows users set up buttons' functions. <Page Jump> and <Constant Setting> are the only two currently supported functions.

A [Page Jump] function setting

- Page Jump setting: After you choose the Page Jump function in the drop down list, you will see this Page Jump Setting Menu
- <Function Key> allows you to assign functions to the following keys on the KPC-CC01 keypad: F1, F2, F3, F4, Up, Down, Left and Right. Please note that the Up and Down keys are locked by TPEditor. These two keys cannot be programmed. If you want to program Up and Down keys, go to Tool→Function Key Settings (F)→Re-Define Up/Down Key(R).

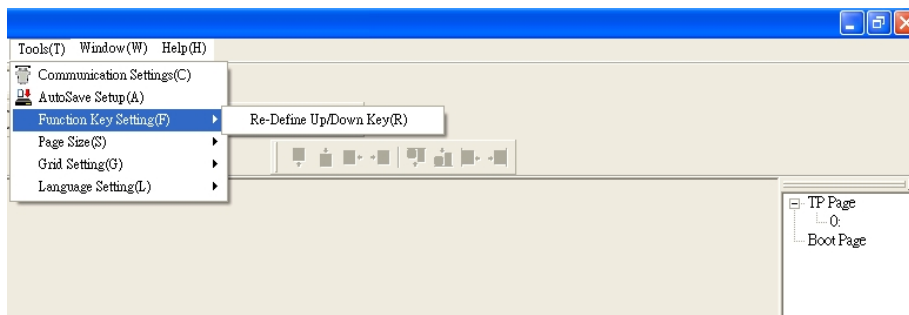

- Button Text: This function allows user to name buttons. For example, key in <Next Page> in the empty space, a button will have the wording <Next Page> displayed on it.

B [Constant setting] function

This function is to set up the memory address' value of the VFD or PLC. When pressing the <function button> set up in before, a value will be written to the memory address of the <Constant Setting>. This function can be used as initializing a variable.



7. Clock Display Setting  : The setup window of the Clock Display is shown as the image below. Time, Day or Date can be displayed on the keypad.
Open a new file and click once in that window, you will see the following
In the clock display setting, you can choose to display Time, Day or Date on the Keypad. To adjust time, go to #9 on the Keypad's menu. You can also adjust Frame Setting, Font Setting and Alignment.

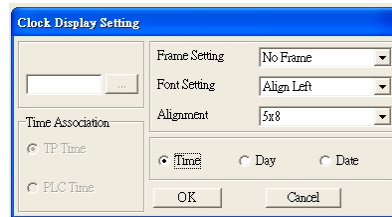

8. Multi-state bitmap  : The setup window of the multi-state is shown as the image below. This object reads the bit's property value of the PLC. It defines what image or wording is when this bit is 0 or when this bit is 1. Set the initial status to be 0 or 1 to define the displayed image or wording.

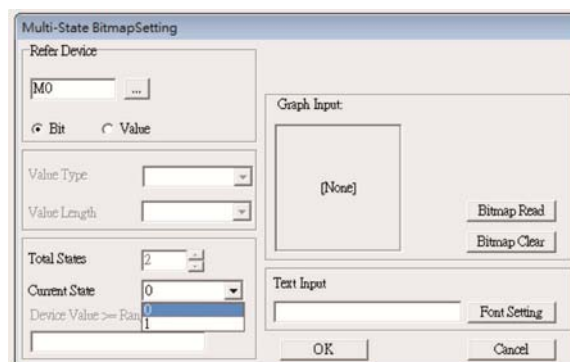

9. Unit Measurement  : Click once on this Button:
Open a new file and double click on that window, you will see the following

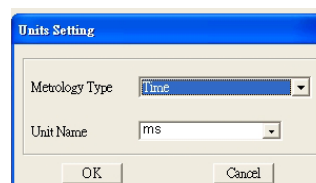

Choose from the drop down list the Metrology and the Unity Name that you need.
As for Metrology, you have the following choices Length, Square Measure, Volume/Solid Measure, Weight, Speed, Time and Temperature. The unit name changes automatically when you change metrology type.

10. Numeric Input Setting

This menu allows you to provide parameters or communication ports and to input numbers.

Click once on this button 

Open a new file and double click on that window, you will see the following:

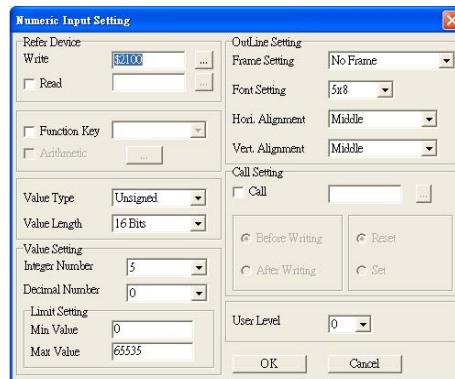

- Related Device: There are two blank spaces to fill in, one is <Write> and another one is <Read>. Input the numbers that you want to display and the corresponding numbers of a parameter and that of a communication port. For example, input 012C to Read and Write Parameter P01-44.
- OutLine Setting: The Frame setting, Font setting, Vertical Alignment and Horizontal Alignment are the same as mentioned before. Click on the drop down menu and choose the setting that you need.
- Function key: The setting here allows you to program keys on the keypad. Press the key on the menu then the corresponding key on the keypad will start to blink, then press Enter to confirm the setting.
- Value Type & Value Length: These two factors influence the range of the Minimum and Maximum Value of the Limit Setting. Please note that the corresponding supporting values for C2000 have to be 16bits. The 32bits values are not supported.
- Value Setting: This part is set automatically by the keypad itself.
- Limit Setting: Input the range the security setting here.
- For example, if you set Function Key as F1, Minimum Value as 0 and Maximum Value as 4, then press F1 on Keypad Then you can press Up and Down key on the keypad to increase or decrease the value. Press Enter Key on the keypad to confirm your setting. You can also go to parameter table 01-44 to verify if your input correctly the value.

11. Download TP Page : Press Up or Down key on the keypad until you reach #13 PC Link.

Then press Enter on the keypad and you will see the word "Waiting" on keypad's screen. Now choose a page that you have created then go to Communication (M)→Write to TP(W) to start downloading the page to the keypad

When you see the word Completed on the keypad's screen, that means the download is done. Then you can press ESC on the keypad to go back to the menu of the keypad.

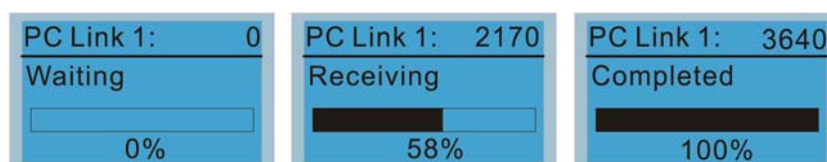
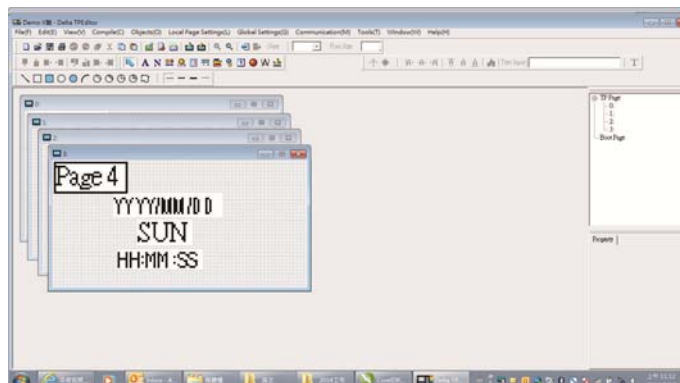

3) Edit Main Page

1. On the bottom right-hand corner of the HMI, click on a page number to edit or go to VIEW >HMI page to start editing main page. As shown in the image, the following objects are available. From left to right: Static Text, ASCII Display, Static Bitmap, Scale, Bar Graph, Button, Clock Display, Multi-state bit map, Units, Numeric Input and 11 geometric bitmaps and lines of different width. The application of Static Text, Static Bitmap, and geometric bitmap is the same as the editing startup page.

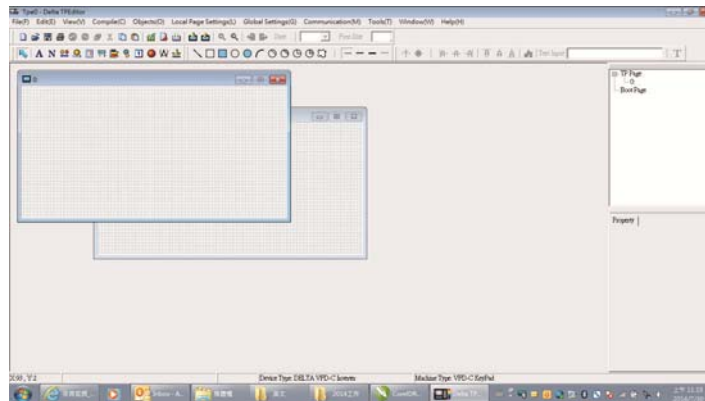

2. Numeric/ASCII Display : To add a Numeric/ASCII Display object to a screen, double click on the object to set up Related Devices, Frame Setting , Fonts and Alignment.

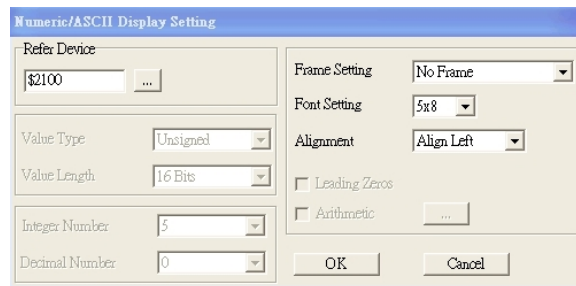

Related Device: Choose the VFD Communication Port that you need, if you want to read output frequency (H), set the VFD Communication Port to \$2202. For other values, please refer to ACMD ModBus Comm Address List.



3. Scale Setting  : On the Tool Bar, click on this  for Scale Setting. You can also edit Scale Setting in the Property Window on the right hand side of your computer screen.

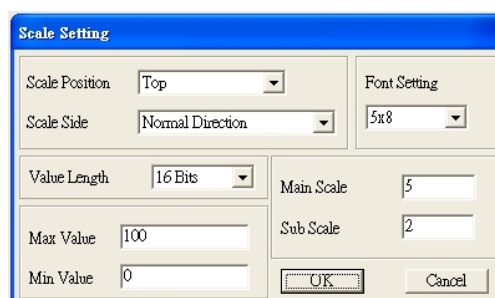

- i. Scale Position: Click on the drop down list to choose which position that you need to place a scale.
- ii. Scale Side: Click on the drop down list to choose if you want to number your scale from smaller number to bigger number or from big to small. Click OK to accept this setting or click Cancel to abort.
- iii. Font Setting: Click on the drop down list to choose the Font setting that you need then click OK to accept the setting or click Cancel to abort.
- iv. Value Length: Click on the drop down to choose 16bits or 32 bits. Then click OK to accept the setting or click Cancel to abort.
- v. Main Scale & Sub Scale: In order to divide the whole scale into equal parts, key in the numbers of your choices for main scale and sub scale.
- vi. Maximum value & Minimum Value are the numbers on the two ends of a scale. They can be negative numbers. But the values allowed to be input are limited by the length of value. For example, when the length of value is set to **be hexadecimal**, the maximum and the minimum value cannot be input as -4000.

Follow the Scale setting mentioned above; you will have a scale as shown below.

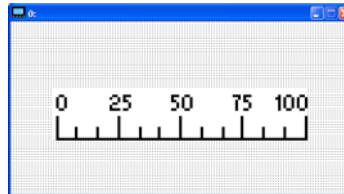

4. Bar Graph setting :

- i. Related Device: Choose the VFD Communication Port that you need.
- ii. Direction Setting: Click on the drop down menu to choose one of the following directions: From Bottom to Top, From Top to Bottom, From Left to Right or From Right to Left.
- iii. Maximum Value & Minimum Value: They define the range covered by the maximum value and minimum value. If a value is smaller than or equal to the minimum value, then the bar graph will be blank. If a value is bigger or equal to the maximum value, then the bar graph will be full. If a value is between minimum and maximum value, then the bar graph will be filled proportionally.

5. Button : Currently this function only allows the Keypad to switch pages, other functions are not yet available. Text input function and Image inserted functions are not yet supported.

Double click on  to open set up window.

<Button Type> allows users set up buttons' functions. <Page Jump> and <Constant Setting> are the only two currently supported functions.

A [Page Jump] function setting

- Page Jump setting: After you choose the Page Jump function in the drop down list, you will see this Page Jump Setting Menu
- <Function Key> allows you to assign functions to the following keys on the KPC-CC01 keypad: F1, F2, F3, F4, Up, Down, Left and Right. Please note that the Up and Down keys are locked by TPEditor. These two keys cannot be programmed. If you want to program Up and Down keys, go to Tool→Function Key Settings (F)→Re-Define Up/Down Key(R).

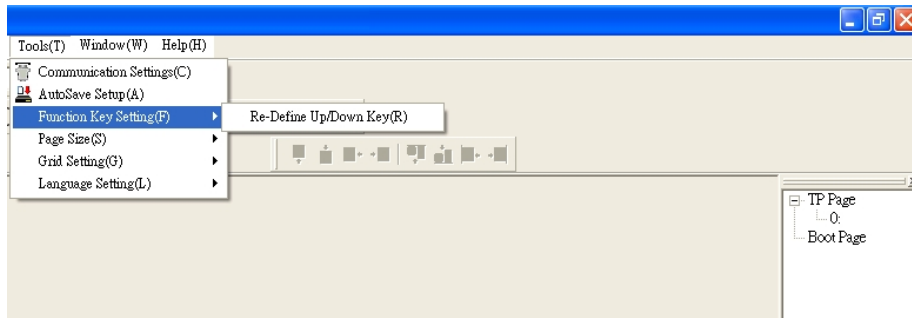

- Button Text: This function allows user to name buttons. For example, key in <Next Page> in the empty space, a button will have the wording <Next Page> displayed on it.

B [Constant setting] function

This function is to set up the memory address' value of the VFD or PLC. When pressing the <function button> set up in before, a value will be written to the memory address of the <Constant Setting>. This function can be used as initializing a variable.

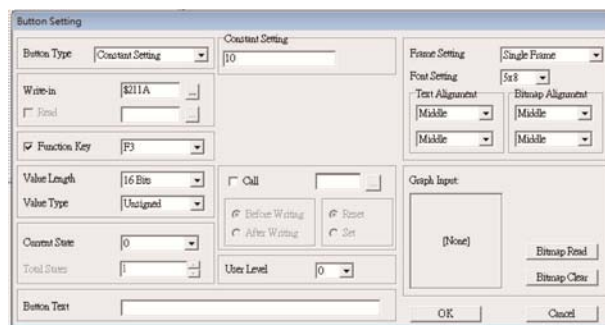

11. Clock Display Setting : The setup window of the Clock Display is shown as the image below. Time, Day or Date can be displayed on the keypad.

Open a new file and click once in that window, you will see the following

In the clock display setting, you can choose to display Time, Day or Date on the Keypad. To adjust time, go to #9 on the Keypad's menu. You can also adjust Frame Setting, Font Setting and Alignment.

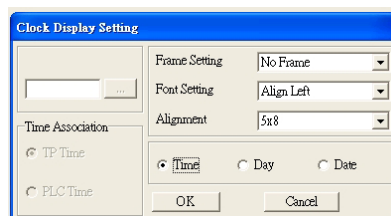

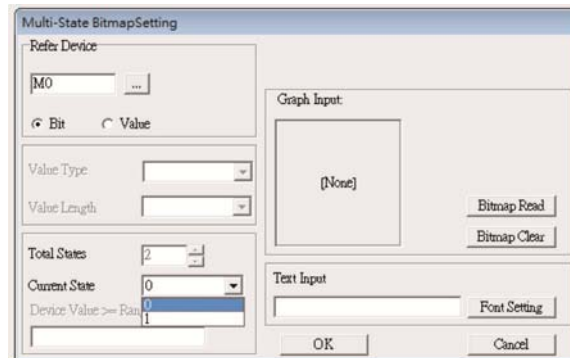

12. Multi-state bitmap : The setup window of the multi-state is shown as the image below. This object reads the bit's property value of the PLC. It defines what image or wording is when this bit is 0 or when this bit is 1. Set the initial status to be 0 or 1 to define the displayed image or wording.

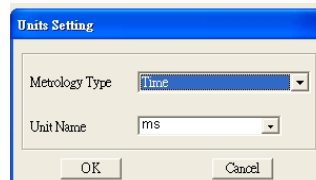

13. Unit Measurement : Click once on this Button:
Open a new file and double click on that window, you will see the following



Choose from the drop down list the Metrology and the Unity Name that you need. As for Metrology, you have the following choices Length, Square Measure, Volume/Solid Measure, Weight, Speed, Time and Temperature. The unit name changes automatically when you change metrology type.

14. Numeric Input Setting :
This menu allows you to provide parameters or communication ports and to input numbers.
Click once on this button .
Open a new file and double click on that window, you will see the following:

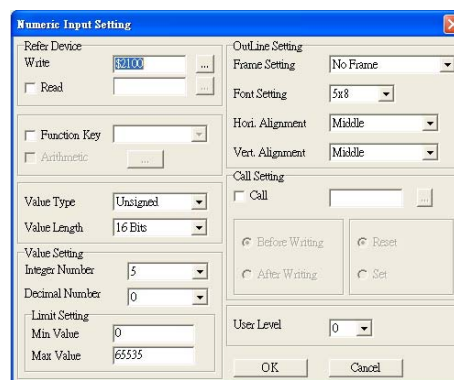

- h. Related Device: There are two blank spaces to fill in, one is <Write> and another one is <Read>. Input the numbers that you want to display and the corresponding numbers of a parameter and that of a communication port. For example, input 012C to Read and Write Parameter P01-44.
- i. OutLine Setting: The Frame setting, Font setting, Vertical Alignment and Horizontal Alignment are the same as mentioned before. Click on the drop down menu and choose the setting that you need.
- j. Function key: The setting here allows you to program keys on the keypad. Press the key on the menu then the corresponding key on the keypad will start to blink, then press Enter to confirm the setting.
- k. Value Type & Value Length: These two factors influence the range of the Minimum and Maximum Value of the Limit Setting. Please note that the corresponding supporting values for C2000 have to be 16bits. The 32bits values are not supported.
- l. Value Setting: This part is set automatically by the keypad itself.

- m. Limit Setting: Input the range the security setting here.
- n. For example, if you set Function Key as F1, Minimum Value as 0 and Maximum Value as 4, then press F1 on Keypad Then you can press Up and Down key on the keypad to increase or decrease the value. Press Enter Key on the keypad to confirm your setting. You can also go to parameter table 01-44 to verify if your input correctly the value.

15. Download TP Page : Press Up or Down key on the keypad until you reach #13 PC Link.

Then press Enter on the keypad and you will see the word "Waiting" on keypad's screen. Now choose a page that you have created then go to Communication (M)→Write to TP(W) to start downloading the page to the keypad

When you see the word Completed on the keypad's screen, that means the download is done. Then you can press ESC on the keypad to go back to the menu of the keypad.

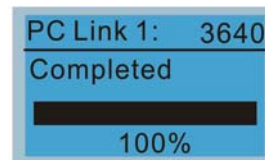
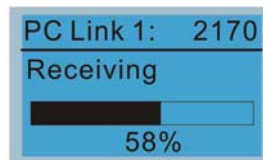
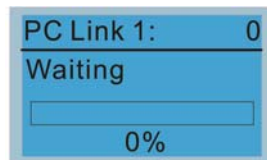
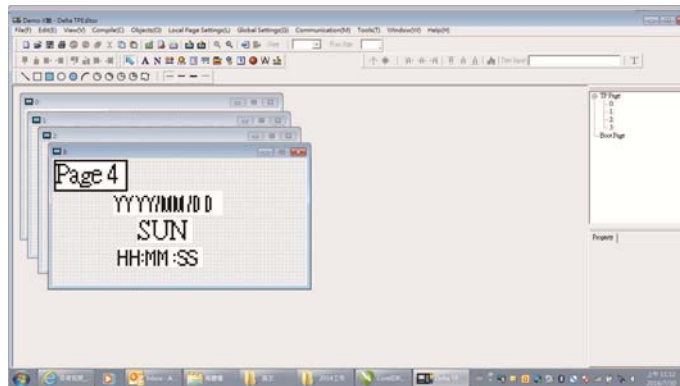

10 Auto-tuning Process

■ Flow Chart

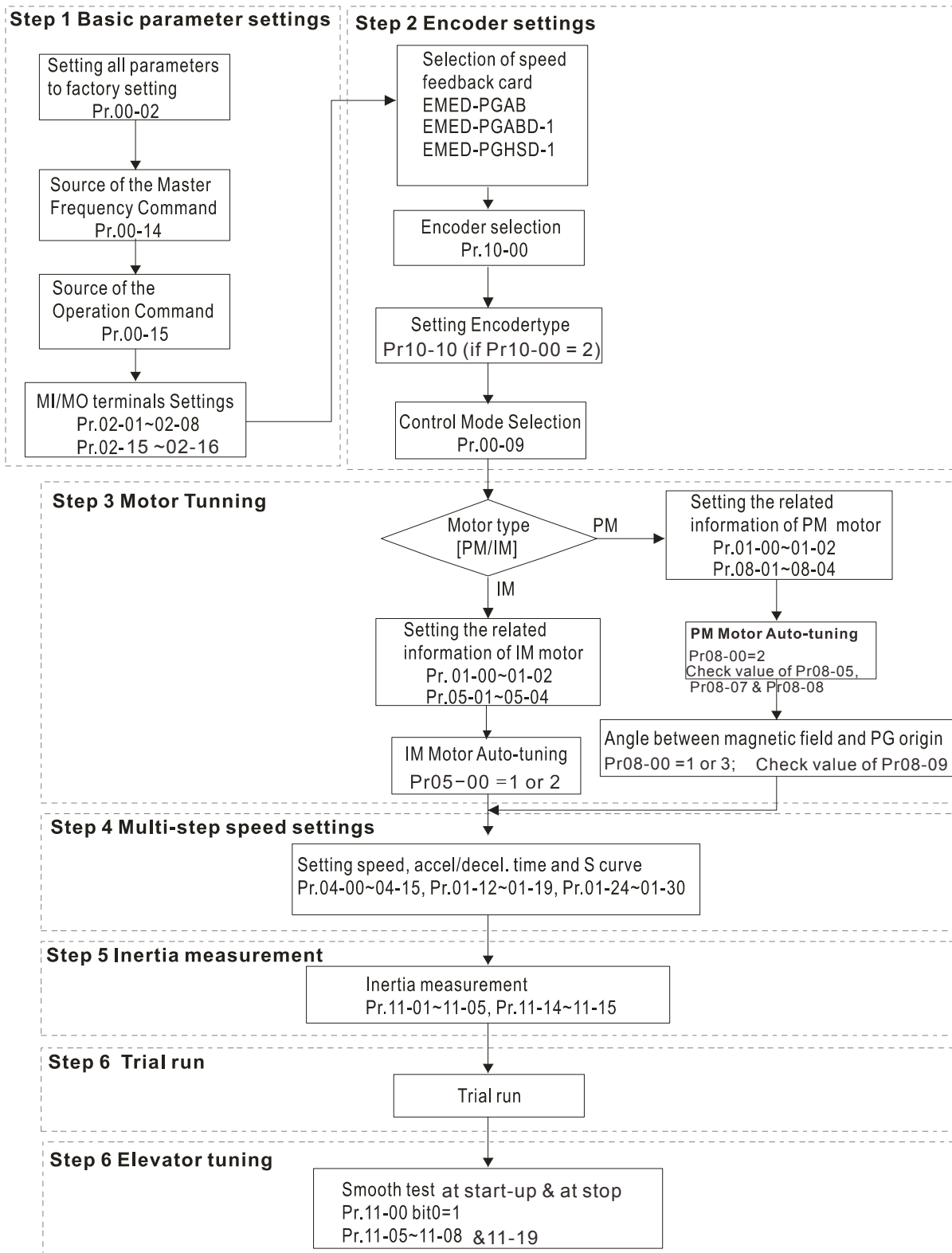

■ Explanations for the Auto-tuning Steps

Step1

Basic Parameters Settings

- Make sure that Pr.00-00 (identity code of the AC motor drive) corresponds with the nameplate indicated on the AC motor drive.
-
- Make sure that all parameters are reset to factory setting (Pr.00-02 is set to 9 or 10).

Pr00-02	0: No function
Parameter	1: Read only
Reset	8: Keypad lock
	9: All parameters are reset to factory settings (base frequency = 50Hz)
	10: All parameters are reset to factory settings (base frequency = 60Hz)

-
- Source of the Master Frequency Command: It is user-defined. (Pr.00-14)
-

Pr00-14	1: RS-485 serial communication or digital keypad (KPC-CC01)
Source of the Master Frequency Command	2: External analog input (Pr. 03-00)
	3: Digital terminals input (Pr04-00 ~ Pr.04-15)

-
- Source of the Operation Command: It is user-defined. (Pr.00-15)
-

Pr00-15	1: External terminals
Source of the operation frequency	2: RS-485 serial communication or digital keypad (KPC-CC01)

- MI/MO External Terminal Settings:

Refer to Pr.02-01~Pr02-08 for setting of the external input terminals MI1~MI8.

NOTE: The factory setting of Pr.02-08 is 40 (Enable drive function).

Disable this function, if you don't need to use it.

Settings of Pr02-01 to Prp02-08	0: No function
	1: multi-step speed command 1
	2: multi-step speed command 2
	3: multi-step speed command 3
	4: multi-step speed command 4
	5: Reset
	6: JOG command
	7: Acceleration/ Deceleration Speed inhibit
	8: the 1st, 2nd acceleration/deceleration time selection
	9: the 3rd, 4th acceleration/deceleration time selection
	10: EF input (07-28)
	11: Reserved
	12: Stop Output
	13: Reserved
	14: Reserved
	15: Operation speed command form AUI1
	16: Reserved
	17: operation speed command form AUI2
	18: Emergency stop (Pr07-28)
	19~23: Reserved
	24: FWD JOG command

25: REV JOG command
 26: Reserved
 27: ASR1/ASR2 selection
 28: Emergency stop (EF1) (Motor coasts to stop)
 29-30: Reserved
 31: High torque bias (by Pr.07-21)
 32: Middle torque bias (by Pr.07-22)
 33: Low torque bias (by Pr.07-23)
 34-37: Reserved
 38: Disable write EEPROM function
 39: Torque command direction
 40: Enable drive function
 41: Detection for magnetic contactor
 42: Mechanical brake
 43: EPS function

Refer to Pr02-15 and Pr02-16 for the settings of MO1~MO8

Pr02-15~ 0: No function
 Pr02-16 1: Operation indication
 2: Operation speed attained
 3: Desired frequency attained 1 (Pr.02-25)
 4: Desired frequency attained 2 (Pr.02-27)
 5: Zero speed (frequency command)
 6: Zero speed with stop (frequency command)
 7: Over torque (OT1) (Pr.06-05~06-07)
 8: Over torque (OT2) (Pr.06-08~06-10)
 9: Drive ready
 10: User-defined Low-voltage Detection (LV)
 11: Malfunction indication
 12: Mechanical brake release (Pr.02-29, Pr.02-30)
 13: Overheat (Pr.06-14)
 14: Brake chopper signal
 15: Motor-controlled magnetic contactor output
 16: Slip error (oSL)
 17: Malfunction indication
 18: Reserved
 19: Brake chopper output error
 20: Warning output
 21: Over voltage warning
 22: Over-current stall prevention warning
 23: Over-voltage stall prevention warning
 24: Operation mode indication (Pr.00-15≠0)
 25: Forward command
 26: Reverse command
 27: Output when current \geq Pr.02-33
 28: Output when current $<$ Pr.02-33
 29: Output when frequency \geq Pr.02-34
 30: Output when frequency $<$ Pr.02-34
 31-32: Reserved
 33: Zero speed (actual output frequency)
 34: Zero speed with Stop (actual output frequency)
 35: Error output selection 1 (Pr.06-22)
 36: Error output selection 2 (Pr.06-23)
 37: Error output selection 3 (Pr.06-24)
 38: Error output selection 4 (Pr.06-25)
 39: Reserved
 40: Speed attained (including zero speed)
 41: Reserved
 42: STO output error

Step2

Encoder Settings

- Selection of speed feedback cards
 - Refer to CH07 Speed Feedback Card Selection. Delta provides 3 kinds of PG card for user to choose, including EMED-PGABD-1, EMED-PGHSD-1, EMED-PGAB-0.

Pr10-00	0: No function
Type of PG signal	1: ABZ
	2: ABZ+Hall
	3: SIN/COS + Sinusoidal
	4: SIN/COS + Endat
	5: SIN/COS
	6: SIN/COS + Hiperface

- Encoder settings: Pr.10-01~Pr.10-02

Detection for the magnetic pole position of motor

The detection method will be different by the setting of Pr.10-00 PG Signal Type.

The detection methods: (refer to Pr.10-00)

- Setting 1 or 5: The AC motor drive will output short circuit to detect the position of the magnetic pole. At this moment, the motor will generate a little noise.
- Setting 2: The AC motor drive will detect the position of the magnetic pole by the UVW signal of PG.
- Setting 3: The AC motor drive will detect the position of the magnetic pole by the sine signal of PG.
- Setting 4: The AC motor drive will detect the position of the magnetic pole by the communication signal of PG.

Pr10-01	1~25000
Encoder Pulse	

Type of Encoder Input Setting. The setting of this parameter is normally 1. If the motor doesn't run at setting 1, change to setting 2.

Pr10-02	0: No function
Type of Encoder Input Setting	1: Phase A leads in a forward run command and phase B leads in a reverse run command
	2: Phase B leads in a forward run command and phase A leads in a reverse run command
	3: Phase A is a pulse input and phase B is a direction input. (low input=reverse direction, high input=forward direction)
	4: Phase A is a pulse input and phase B is a direction input. (low input=forward direction, high input=reverse direction)
	5: Single-phase input

Step 3

Motor tuning

- Setting the parameters according to the motor type (PM or IM)
- Motor Auto-tuning: When the Source of the Operation Command is set to digital keypad (Pr.00-15=2, refer to step 1)
- Control method: Please set Pr.00-09 to 8.

Pr00-09 Control Method	0: V/f Control
	1: V/f Control + Encoder (VFPG)
	2: Sensorless vector control (SVC)
	3: FOC vector control + Encoder (FOCPG)
	4: Torque control + Encoder (TQCPG)
	8: FOC PM control (FOCPM)

- NOTE: Setting parameter by the motor type (PM or IM).
- Inputting the nameplate information on the motor into Pr.01-00~01-02

Pr01-00 Maximum Output Frequency	10.00~400.00Hz
-------------------------------------	----------------

Pr01-01 1st Output Frequency Setting 1 (base frequency/ motor rated frequency)	0.00~400.00Hz
---	---------------

Pr.01-02 1st Output Voltage Setting 1 (base voltage/ motor rated voltage)	230V models: 0.0V~255.0V 460V models: 0.0V~510.0V
--	--

【IM (Induction Motor)】

- Motor Auto-tuning: When the Source of the Operation Command is set to digital keypad (Pr.00-15=2, refer to step 1) and setting Pr.05-00=2
-

Pr05-00 Motor Auto Tuning	0: No function
	1: Rolling test (Rs, Rr, Lm, Lx, no-load current) , (Motor runs)
	2: Static Test (Motor doesn't run)

NOTE 1: It doesn't need to release the brake in this auto tuning operation. Please make sure that the electromagnetic valve is ON when it is used between the AC motor drive and motor. When Pr.05-00 is set to 2, no-load current of motor must be entered into Pr.05-05. The warning message "Auto tuning" will be displayed on the digital keypad during tuning until it is finished. Then, the measure result will be saved into Pr.05-06~Pr.05-09.

NOTE 2: It needs to finish motor auto tuning before measuring the angle between magnetic pole and PG origin.

Pr05-01 Full-load Current of Motor	(40~120%) *00-01 Amps
---------------------------------------	-------------------------

Pr05-02 Rated Power of Motor	0.00~655.35kW
---------------------------------	---------------

Pr05-03 Rated Speed of Motor(rpm)	0~65535
--------------------------------------	---------

Pr05-04 Number of Motor Poles	2~9
-------------------------------------	-----

【Permanent Magnet Motor】

- Motor Auto-tuning: When the Source of the Operation Command is set to digital keypad (Pr.00-15=2, refer to step 1) and setting Pr.08-00=2

Pr08-00 Motor Auto Tuning	0: No function 1: Only for the unloaded motor, auto measure the Angle between magnetic pole and PG origin (08-09) 2: For PM parameters 3: Auto measure the Angle between magnetic pole and PG origin (08-09)
------------------------------	---

NOTE 1: It doesn't need to release the brake in this auto tuning operation. Please make sure that the electromagnetic valve is ON when it is used between the AC motor drive and motor. The warning message "Auto tuning" will be displayed on the digital keypad during tuning until it is finished. Then, the measure result will be saved into Pr.08-05 and Pr.08-07. (Pr.08-05 is Rs of Motor and Pr.08-07 is Lq of Motor)

NOTE 2: It is recommended to set Pr.08-00 to 1 (unloaded motor) for the most accurate calculation. If it needs to execute this function with loaded motor, please balance the carriage before execution.

When Pr.08-00=1, please note:

- When executing the function of auto measure the Angle between magnetic pole and PG origin, it is recommended to stop the carriage car at the middle level.
- Make sure that the electromagnetic valve and mechanical brake are OFF before executing this function.
- When Pr.08-00=1, please execute this function with unloaded motor to get the most accurate result. If it needs to execute this function with loaded motor, please balance the carriage before execution. Make sure the balance by releasing the brake manually before running. This balance will affect the accuracy and the accuracy will influence the power efficiency in driving the motor.

NOTE 3: If it doesn't allow balancing carriage in the measured environment, it can set Pr.08-00 to 3 for executing this function. It will have a difference of 15~30° by the different encoder type.

- When Pr.08-00 is set to 3, the driver will execute the function by the setting of Pr.10-00. The difference between Pr.08-00=3 and Pr.08-00=1 is it doesn't need to put the balanced carriage when Pr.08-00=3. Besides, the operation status of the motor will be as shown in the above table (Pr.10-00=1, 2, 3 and 5, the motor will run. Pr.10-00=4 and 6, the motor won't run)
- When Pr.08-00=3, please make sure if the setting of Pr.10-02 is correct. The incorrect setting will result in the wrong position of the magnetic pole and make the wrong angle between magnetic pole and PG origin.
-

NOTE 4: The warning message "Auto tuning" will be displayed on the digital keypad during tuning until it is finished. Then, the measure result will be saved into Pr.08-09.

NOTE 5: If the warning message "Auto Tuning Err" displayed on the digital keypad during tuning due to abnormal drive or human factor, please check if the wiring is correct. When the warning message "PG Fbk Error" displayed on the digital keypad, please change the setting of Pr.10-02 (for example: if it was set to 1, please change it to 2). When the warning message "PG Fbk Loss" is displayed on the digital keypad, please check the feedback of Z-phase pulse.

Pr.08-01 Full-load Current of Motor	(40~120%)*00-01 Amps
Pr.08-02 Rated power of Motor	0.00~655.35 kW
Pr.08-03 Rated speed of Motor (rpm)	0~65535
Pr.08-04 Number of Motor Poles	2~96

■ Measure the angle between magnetic pole and PG origin

To execute "RUN" by keypad or digital terminals:

1. Using digital keypad: setting Pr.08-00 to 1 and press "RUN" to execute "auto measure the angle between magnetic pole and PG origin". Please note that if the electromagnetic valve and brake are not controlled by the AC motor drive, please release it by manual.
2. Using external terminals: setting Pr.00-14=3 (frequency source) and Pr.00-15=1 (operation source). Please use "inspection" function to execute "auto measure the angle between magnetic pole and PG origin".

For the IM, it doesn't need to detect the position of the magnetic pole; this function (auto measure the Angle between magnetic pole and PG origin) doesn't have to be executed.

Measure the angle between magnetic pole and PG origin: Pr.08-00=1 or 3

Pr.08-00 Motor Auto tuning	<p>0: No function</p> <p>1: Only for the unloaded motor, auto measure the Angle between magnetic pole and PG origin (08-09)</p> <p>2: For PM parameters</p> <p>3: Auto measure the Angle between magnetic pole and PG origin (08-09)</p>
-------------------------------	--

NOTE: The function of "auto measure the angle between magnetic pole and Pg origin" only can be enabled after finishing motor auto-tuning.

Step 4**Multi-Step Speed setting or Analog setting****(Do not wire the two settings at the same time)****A. Multi-step speed settings**

- Confirm the total speed steps (high speed, middle speed, low speed, creep, inspection and level auto-learning)
- Make sure that the setting of step speeds and the action of the corresponding terminals of multi-function input commands are correct.
- Setting multi-step speeds in Pr.04-00 to Pr.04-15

Settings of Pr.04-00 to Pr.04-15	Zero Step Speed Frequency	0.00~400.00Hz
	1st Step Speed Frequency	0.00~400.00Hz
	2nd Step Speed Frequency	0.00~400.00Hz
	3rd Step Speed Frequency	0.00~400.00Hz
	4th Step Speed Frequency	0.00~400.00Hz
	5th Step Speed Frequency	0.00~400.00Hz
	6th Step Speed Frequency	0.00~400.00Hz
	7th Step Speed Frequency	0.00~400.00Hz
	8th Step Speed Frequency	0.00~400.00Hz
	9th Step Speed Frequency	0.00~400.00Hz
	10th Step Speed Frequency	0.00~400.00Hz
	11th Step Speed Frequency	0.00~400.00Hz
	12th Step Speed Frequency	0.00~400.00Hz
	13th Step Speed Frequency	0.00~400.00Hz
	14th Step Speed Frequency	0.00~400.00Hz
15th Step Speed Frequency	0.00~400.00Hz	

NOTE: It is recommended to set the max. operating frequency to the half of max. operating frequency before confirming the setting of each step speed and the action of the corresponding terminals of multi-function input commands.

- Setting the acceleration/deceleration with Pr.01-23 and the setting 08 (the 1st, 2nd acceleration/deceleration time selection) and 09 (the 3rd, 4th acceleration/deceleration time selection) of multi-function input command Pr.02-01~02-08.
- Settings of acceleration/deceleration time: Pr.01-12~Pr.01-19

Settings of Pr.01-12 to Pr.01-19	Accel Time 1	0.00~600.00 sec
	Decel Time 1	0.00~600.00 sec
	Accel Time 2	0.00~600.00 sec
	Decel Time 2	0.00~600.00 sec
	Accel Time 3	0.00~600.00 sec
	Decel Time 3	0.00~600.00 sec
	Accel Time 4	0.00~600.00 sec
	Decel Time 4	0.00~600.00 sec

NOTE: it is recommended to set the Pr.01-31 (deceleration time) to the small value in the trial run and execute smooth test after all the actions are correct.

■ Settings of S curve: Pr.01-24~Pr.01-30

Settings of Pr.01-24 to Pr.01-30	S-curve for Acceleration Departure Time S1	0.00~25.00 sec
	S-curve for Acceleration Arrival Time S2	0.00~25.00 sec
	S-curve for Deceleration Departure Time S3	0.00~25.00 sec
	S-curve for Deceleration Arrival Time S4	0.00~25.00 sec
	Mode Selection when Frequency < Fmin	0: Output waiting 1: Zero-speed operation 2: Fmin (4th output frequency setting)
	Switch Frequency for S3/S4 Changes to S5	0.00~400.00Hz
	S-curve for Deceleration Arrival Time S5	0.00~25.00 sec

NOTE: it is recommended to set the S curve time to 0 in trial run and execute smooth test after all the actions are correct.

B. Analog setting

1. Set Pr00-14=2, frequency command is assigned by the external analog signal.
2. Set Pr00-15 =1, operating command is assigned by the external terminals.
3. In order to work with the control terminal, set up Pr03-23 or Pr03-24 in accordance with the output mode of the controller
4. Set up Pr03-03, PR03-05 or Pr03-06 to work with the connecting port. Set F to display 0Hz when the motor drive is going to stop.

Step 5

Inertia: For synchronous motor, set Pr11-05 = 40%. For asynchronous motor, set Pr11-05 = 80%.

Pr.11-05 Inertial Ratio	1~300%
----------------------------	--------

Step 6**Trial run**

This step is used to trial run after finishing the settings of Step 1 to Step 5 to check if it runs normally after executing the inspection with the loaded motor. At the same time, please also check if the operations of multi-function output terminals is normal, such as the action of the brake release and electromagnetic valve correspond to the host controller.

It needs to check the switch between each step speed, current value, the noise in the carriage and noise source during operation.

Step 7

Elevator tuning

1. Setting Pr. 11-00 to bit 0=1

Pr.11-00 System control	Bit 0=0: disable Bit 0=1: ASR Auto tuning, PDFF enable Bit 7=1: When position control is enabled, it doesn't need to set Pr.07-02 (DC Brake Current Level)
----------------------------	--

2. Smooth test for general operation

- Adjust the setting of Pr.11-05

Pr.11-05 Inertial Ratio	1~300%
----------------------------	--------

- Adjust the settings of Pr.11-06 to Pr.11-08

Settings of Pr.11-06 to Pr.11-08	Zero-speed Bandwidth	0~40Hz
	Low-speed Bandwidth	0~40Hz
	High-speed Bandwidth	0~40Hz

3. Start-up adjustment (only for PM)

- Control by the zero-speed position

Setting Pr.11-00, 10-19, 10-22, 10-23, 02-29 and 10-24

Pr.11-00 System control	Bit 0=0: disable Bit 0=1: ASR Auto tuning, PDFF enable Bit 7=1: When position control is enabled, it doesn't need to set Pr.07-02 (DC Brake Current Level) Bit 15=0: when power is applied, it will detect the position of magnetic pole again Bit 15=1: when power is applied, it will start from the magnetic pole position of previous power failure
Pr.10-19 Zero Speed Gain (P)	0~655.00%

NOTE: refer to the explanations in Pr.02-32

Pr.10-22 Operation Time of Zero Speed	0.000~65.535sec
--	-----------------

Pr.10-23 Filter Time of Zero Speed	0.000~65.535sec
---------------------------------------	-----------------

Pr.10-24 Time for Zero Speed Execution	0: after the brake release set in Pr.02-29 1: after the brake signal input (Pr.02-01~02-08 is set to 42)
---	---

Pr.02-29 Brake Release Delay Time when Elevator Starts	0.000~65.000 Sec
---	------------------

NOTE: When Pr.10-24=0, the zero speed control needs to be used with Pr.02-29. (Refer to the explanations in Pr.02-32)

■ Function of the preload input

Connect the preload signal to the external terminal of the AC motor drive (AUI1) and setting Pr.03-00=3, 07-19=1, 03-03, 03-06 and 03-09.

Pr.03-00 Analog Input 1 (AUI1)	0: No function 1: Frequency command (torque limit under TQR control mode) 2: Torque command (torque limit under speed mode) 3: Torque compensation command 4-5: Reserved 6: P.T.C. thermistor input value 7: Positive torque limit 8: Negative torque limit 9: Regenerative torque limit 10: Positive/negative torque limit
-----------------------------------	--

Pr.07-19 Source of Torque Offset	0: Disable 1: Analog input (Pr.03-00) 2: Torque offset setting (Pr.07-20) 3: Control by external terminal (by Pr.07-21 to Pr.07-23)
-------------------------------------	--

Pr.03-03 Analog Input Bias 1 (AUI1)	-100.0~100.0%
--	---------------

Pr.03-06 Positive/negative Bias Mode (AUI1)	0: Zero bias 1: Lower than bias=bias 2: Greater than bias=bias 3: The absolute value of the bias voltage while serving as the center 4: Serve bias as the center
--	--

Pr.03-09 Analog Input Gain 1 (AUI1)	-500.0~500.0%
--	---------------

NOTE: Pr.03-03, 03-06 and 03-09 are used to adjust the analog input signal.

- 07-19: Source of torque offset
- 03-00~02: Analog input selections (AUI1/AUI2)
- 03-03~05: Analog input bias (AUI1/AUI2)
- 03-06~08: AUI1/AUI2 bias mode

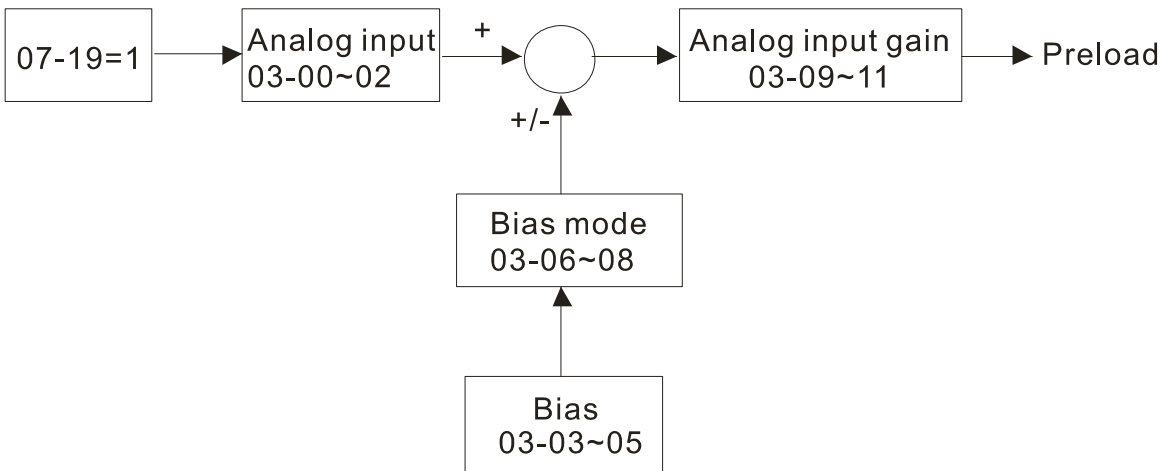

4. Setting of drive stop



Adjusting Pr.01-29, Pr.01-30, Pr.01-31 and Pr.11-19

Pr.01-29 Switch Frequency for S3/S4 Changes to S5	0.00~400.00Hz
Pr.01-30 S-curve for Deceleration Arrival Time S5	0.00~25.00 sec
Pr.11-19 Zero-speed Holding Bandwidth	0~40Hz
Pr.01-31 Deceleration Time	0.00~600.00 sec

11 Summary of Parameter Settings

This chapter provides summary of parameter settings for user to gather the parameter setting ranges, factory settings and set parameters. The parameters can be set, changed and reset by the digital keypad.

NOTE

- 1) : The parameter can be set during operation.
- 2) For more detail on parameters, please refer to Ch12 Description of Parameter Settings.
- 3)  indicates that the parameters or the setting value only applies on the Direct Docking Mode. The actual functions of each elevator controller vary from one to another. For more information, contact Delta.
- 4) The parameters described in this user manual are designed for multi-speed mode. The factory setting of direct docking mode are different from the factory setting described in this user manual. If you need to use the direct docking mode, contact Delta for more information.

00 Drive Parameters



NOTE

IM: Induction Motor; PM: Permanent Magnet Motor

Pr.	Explanation	Setting Range	Factory Setting	VF	VFP	SVC	FOCPG	TQCPG	FOCPM
				<input type="radio"/>	<input type="radio"/>	<input type="radio"/>	<input type="radio"/>	<input type="radio"/>	<input type="radio"/>
00-00	Identity Code of AC Motor Drive	108: 220V, 3HP (single phase) 110: 220V, 5HP (Single phase) 8: 230V, 3HP 10: 230V, 5HP 11: 460 V, 5HP (4.0kW) 12: 230V, 7.5HP 13: 460V, 7.5HP 14: 230V, 10HP 15: 460V, 10HP 16: 230V, 15HP 17: 460V, 15HP 18: 230V, 20HP 19: 460V, 20HP 20: 230V, 25HP 21: 460V, 25HP 22: 230V, 30HP 23: 460V, 30HP 24: 230V, 40HP 25: 460V, 40HP 26: 230V, 50HP 27: 460V, 50HP 29: 460V, 60HP 31: 460V, 75HP 33: 460V, 100HP	Read Only	<input type="radio"/>	<input type="radio"/>	<input type="radio"/>	<input type="radio"/>	<input type="radio"/>	<input type="radio"/>
00-01	Display AC Motor Drive Rated Current	Display by models	Read only	<input type="radio"/>	<input type="radio"/>	<input type="radio"/>	<input type="radio"/>	<input type="radio"/>	<input type="radio"/>
00-02	Parameter Reset	0: No function 1: Read only	0	<input type="radio"/>	<input type="radio"/>	<input type="radio"/>	<input type="radio"/>	<input type="radio"/>	<input type="radio"/>

		5 : Direct docking mode only ◆ 8: No function 9: All parameters are reset to factory settings(base frequency is 50Hz) 10: All parameters are reset to factory settings (base frequency is 60Hz)								
✓	00-03	Start-up Display Selection	0: Frequency command 1: Output frequency 2: DC BUS voltage 3: Output current 4: Output voltage 5: User defined (00-04)	0	<input type="radio"/>	<input type="radio"/>	<input type="radio"/>	<input type="radio"/>	<input type="radio"/>	<input type="radio"/>
✓	00-04	Content of Multi-function Display	0: Display output current (A) (Unit: Amps) 1: Reserved 2: Display actual output frequency (H.) (Unit: Hz) 3: Display DC-BUS voltage (v) (Unit: Vdc) 4: Display output voltage (E) (Unit: Vac) 5: Display output power angle (n) (Unit: deg) 6: Display output power in kW (P) (Unit: kW) 7: Display actual motor speed rpm (r) (Unit: rpm) 8: Display estimate output torque % (t) (Unit: %) 9: Display PG feedback (G) (refer to Pr.10-00,10-01) (Unit: PLS) 10: Display PID feedback (b) (Unit: %) 11: Display AUI1 in % (1.) (Unit: %) 12: Reserved 13: Display AUI2 in % (2.) (Unit: %) 14: Display the temperature of heat sink In °C (c.) (Unit: °C). 15: Display the temperature of IGBT In °C (c.) (Unit: °C). 16: The status of digital input (ON/OFF) (i) 17: The status of digital output (ON/OFF) (o) 18: Multi-step speed (S) 19: The corresponding CPU pin status of digital input (d)	0	<input type="radio"/>	<input type="radio"/>	<input type="radio"/>	<input type="radio"/>	<input type="radio"/>	<input type="radio"/>

		20: The corresponding CPU pin status of digital output (0.) 21~23: Reserved 24: AC output voltage when error occurred 25: DC-side voltage when error occurred 26: Motor's frequency when error occurred 27: Output current when error occurred 28: Output frequency when error occurred 29: Frequency command when error occurred 30: Output power when error occurred 31: Output torque when error occurred 32: Input terminal status when error occurred 33: Output terminal status when error occurred 34: Status of motor drive when error occurred 35: Display MI status & MO status on LED keypad.								
✓	00-05	User-Defined Coefficient K	Digit 4: decimal point number (0 to 3) Digit 3-0: 40 to 9999	0	<input type="radio"/>	<input type="radio"/>	<input type="radio"/>	<input type="radio"/>	<input type="radio"/>	<input type="radio"/>
	00-06	Software Version	READ ONLY	#. #	<input type="radio"/>	<input type="radio"/>	<input type="radio"/>	<input type="radio"/>	<input type="radio"/>	<input type="radio"/>
✓	00-07	Password Input	1 to 9998 and 10000 to 65535 0 to 2: times of wrong password	0	<input type="radio"/>	<input type="radio"/>	<input type="radio"/>	<input type="radio"/>	<input type="radio"/>	<input type="radio"/>
✓	00-08	Password Set	1 to 9998 and 10000 to 65535 0: No password set or successful input in Pr.00-07 1: Password has been set	0	<input type="radio"/>	<input type="radio"/>	<input type="radio"/>	<input type="radio"/>	<input type="radio"/>	<input type="radio"/>
	00-09	Control Method	0: V/f Control 1: V/f Control + Encoder (VFPG) 2: Sensorless vector control (SVC) 3: FOC vector control + Encoder (FOCPG) 4: Torque control + Encoder (TQCPG) 8: FOC PM control (FOCPM)	0	<input type="radio"/>	<input type="radio"/>	<input type="radio"/>	<input type="radio"/>	<input type="radio"/>	<input type="radio"/>
✓	00-10	Speed Unit	0: Hz 1: m/s 2: ft./s 3 : Direct docking mode only ◆	0	<input type="radio"/>	<input type="radio"/>	<input type="radio"/>	<input type="radio"/>	<input type="radio"/>	<input type="radio"/>
	00-11	Output Direction Selection	0: FWD: counterclockwise, REV: clockwise 1: FWD: clockwise, REV: counterclockwise	0	<input type="radio"/>	<input type="radio"/>	<input type="radio"/>	<input type="radio"/>	<input type="radio"/>	<input type="radio"/>
✓	00-12	Carrier Frequency	2~15KHz	12	<input type="radio"/>	<input type="radio"/>	<input type="radio"/>	<input type="radio"/>	<input type="radio"/>	<input type="radio"/>
✓	00-13	Auto Voltage Regulation (AVR) Function	0: Enable AVR 1: Disable AVR 2: Disable AVR when deceleration stop	0	<input type="radio"/>	<input type="radio"/>	<input type="radio"/>	<input type="radio"/>	<input type="radio"/>	<input type="radio"/>
✓	00-14	Source of the Master Frequency Command	1: RS-485 serial communication or digital keypad (KPC-CC01) 2: External analog input (Pr. 03-00) 3: Digital terminals input (Pr. 04-00~04-15) 4 : Direct docking mode only ◆	1	<input type="radio"/>	<input type="radio"/>	<input type="radio"/>	<input type="radio"/>	<input type="radio"/>	<input type="radio"/>
✓	00-15	Source of the Operation Command	1: External terminals 2: RS-485 serial communication or digital keypad (KPC-CC01)	1	<input type="radio"/>	<input type="radio"/>	<input type="radio"/>	<input type="radio"/>	<input type="radio"/>	<input type="radio"/>

01 Basic Parameters

Pr.	Explanation	Setting Range	Factory Setting	V/F	V/FPG	SVC	FOCPG	TQCPG	FOCPM
				<input type="checkbox"/>	<input type="checkbox"/>	<input type="checkbox"/>	<input type="checkbox"/>	<input type="checkbox"/>	<input type="checkbox"/>
01-00	Maximum Output Frequency	10.00~400.00Hz	60.00/50.00	<input type="checkbox"/>	<input type="checkbox"/>	<input type="checkbox"/>	<input type="checkbox"/>	<input type="checkbox"/>	<input type="checkbox"/>
01-01	1st Output Frequency Setting 1 (base frequency / motor's rated frequency)	0.00~400.00Hz	60.00/50.00	<input type="checkbox"/>	<input type="checkbox"/>	<input type="checkbox"/>	<input type="checkbox"/>	<input type="checkbox"/>	<input type="checkbox"/>
01-02	1st Output Voltage Setting 1 (base voltage/ motor's rated voltage)	230V series: 0.0V~255.0V 460V series: 0.0V~510.0V	220.0 440.0	<input type="checkbox"/>	<input type="checkbox"/>	<input type="checkbox"/>	<input type="checkbox"/>	<input type="checkbox"/>	<input type="checkbox"/>
01-03	2 nd Output Frequency Setting 1	0.00~400.00Hz	0.50	<input type="checkbox"/>	<input type="checkbox"/>				
✓ 01-04	2 nd Output Voltage Setting 1	230V series: 0.0V~255.0V 460V series: 0.0V~510.0V	5.0 10.0	<input type="checkbox"/>	<input type="checkbox"/>				
01-05	3 rd Output Frequency Setting 1	0.00~400.00Hz	0.50	<input type="checkbox"/>	<input type="checkbox"/>				
✓ 01-06	3 rd Output Voltage Setting 1	230V series: 0.0V~255.0V 460V series: 0.0V~510.0V	5.0 10.0	<input type="checkbox"/>	<input type="checkbox"/>				
01-07	4 th Output Frequency Setting 1	0.00~400.00Hz	0.00	<input type="checkbox"/>	<input type="checkbox"/>	<input type="checkbox"/>	<input type="checkbox"/>	<input type="checkbox"/>	
✓ 01-08	4 th Output Voltage Setting 1	230V series: 0.0V~255.0V 460V series: 0.0V~510.0V	5.0 10.0	<input type="checkbox"/>	<input type="checkbox"/>				
01-09	Starting Frequency	0.00~400.00Hz	0.50	<input type="checkbox"/>	<input type="checkbox"/>	<input type="checkbox"/>	<input type="checkbox"/>		
✓ 01-10	Output Frequency Upper Limit	0.00~400.00Hz	120.00	<input type="checkbox"/>	<input type="checkbox"/>	<input type="checkbox"/>	<input type="checkbox"/>		<input type="checkbox"/>
✓ 01-11	Output Frequency Lower Limit	0.00~400.00Hz	0.00	<input type="checkbox"/>	<input type="checkbox"/>	<input type="checkbox"/>	<input type="checkbox"/>		<input type="checkbox"/>
✓ 01-12	Accel Time 1	0.00~600.00 sec.	3.00	<input type="checkbox"/>	<input type="checkbox"/>	<input type="checkbox"/>	<input type="checkbox"/>		<input type="checkbox"/>
✓ 01-13	Decel Time 1	0.00~600.00 sec	2.00	<input type="checkbox"/>	<input type="checkbox"/>	<input type="checkbox"/>	<input type="checkbox"/>		<input type="checkbox"/>
✓ 01-14	Accel Time 2	0.00~600.00 sec	3.00	<input type="checkbox"/>	<input type="checkbox"/>	<input type="checkbox"/>	<input type="checkbox"/>		<input type="checkbox"/>
✓ 01-15	Decel Time 2	0.00~600.00 sec	2.00	<input type="checkbox"/>	<input type="checkbox"/>	<input type="checkbox"/>	<input type="checkbox"/>		<input type="checkbox"/>
✓ 01-16	Accel Time 3	0.00~600.00 sec	3.00	<input type="checkbox"/>	<input type="checkbox"/>	<input type="checkbox"/>	<input type="checkbox"/>		<input type="checkbox"/>
✓ 01-17	Decel Time 3	0.00~600.00 sec	2.00	<input type="checkbox"/>	<input type="checkbox"/>	<input type="checkbox"/>	<input type="checkbox"/>		<input type="checkbox"/>
✓ 01-18	Accel Time 4	0.00~600.00 sec	3.00	<input type="checkbox"/>	<input type="checkbox"/>	<input type="checkbox"/>	<input type="checkbox"/>		<input type="checkbox"/>
✓ 01-19	Decel Time 4	0.00~600.00 sec	2.00	<input type="checkbox"/>	<input type="checkbox"/>	<input type="checkbox"/>	<input type="checkbox"/>		<input type="checkbox"/>
✓ 01-20	JOG Acceleration Time	0.00~600.00 sec	1.00	<input type="checkbox"/>	<input type="checkbox"/>	<input type="checkbox"/>	<input type="checkbox"/>		<input type="checkbox"/>
✓ 01-21	JOG Deceleration Time	0.00~600.00 sec	1.00	<input type="checkbox"/>	<input type="checkbox"/>	<input type="checkbox"/>	<input type="checkbox"/>		<input type="checkbox"/>
✓ 01-22	JOG Frequency	0.00~400.00Hz	6.00	<input type="checkbox"/>	<input type="checkbox"/>	<input type="checkbox"/>	<input type="checkbox"/>	<input type="checkbox"/>	<input type="checkbox"/>
✓ 01-23	Switch Frequency between 1st/4th Accel/ Decel	0.00~400.00Hz	0.00	<input type="checkbox"/>	<input type="checkbox"/>	<input type="checkbox"/>	<input type="checkbox"/>		<input type="checkbox"/>
✓ 01-24	S-curve for Acceleration Departure Time S1	0.00~25.00 sec	1.00	<input type="checkbox"/>	<input type="checkbox"/>	<input type="checkbox"/>	<input type="checkbox"/>		<input type="checkbox"/>
✓ 01-25	S-curve for Acceleration Arrival Time S2	0.00~25.00 sec	1.00	<input type="checkbox"/>	<input type="checkbox"/>	<input type="checkbox"/>	<input type="checkbox"/>		<input type="checkbox"/>
✓ 01-26	S-curve for Deceleration Departure Time S3	0.00~25.00sec.	1.00	<input type="checkbox"/>	<input type="checkbox"/>	<input type="checkbox"/>	<input type="checkbox"/>		<input type="checkbox"/>
✓ 01-27	S-curve for Deceleration Arrival Time S4	0.00~25.00sec.	1.00	<input type="checkbox"/>	<input type="checkbox"/>	<input type="checkbox"/>	<input type="checkbox"/>		<input type="checkbox"/>
01-28	Mode of Selection when Frequency < Fmin	0: Output waiting 1: Zero-speed operation 2: Fmin (4th output frequency setting)	1	<input type="checkbox"/>	<input type="checkbox"/>	<input type="checkbox"/>			
✓ 01-29	Switch Frequency for S3/S4 Changes to S5	0.00~400.00Hz	0.00	<input type="checkbox"/>	<input type="checkbox"/>	<input type="checkbox"/>	<input type="checkbox"/>		<input type="checkbox"/>

↗	01-30	S-curve for Deceleration Arrival Time S5	0.00~25.00sec.	1.00	<input type="radio"/>	<input type="radio"/>	<input type="radio"/>	<input type="radio"/>	<input type="radio"/>	<input type="radio"/>
↗	01-31	Deceleration Time when Operating without RUN Command	0.00~600.00sec.	2.00	<input type="radio"/>	<input type="radio"/>	<input type="radio"/>	<input type="radio"/>	<input type="radio"/>	<input type="radio"/>
	01-32	Direct docking mode only ◆			<input type="radio"/>	<input type="radio"/>	<input type="radio"/>	<input type="radio"/>	<input type="radio"/>	<input type="radio"/>

02 Digital Input/ Output Parameters

Pr.	Explanation	Setting Range	Factory Setting	VF	VFG	SVC	FOCPG	TQCPG	FOCPM
02-00	2-wire/3-wire Operation Control	0: FWD/STOP, REV/STOP 1: FWD/STOP, REV/STOP (Line Start Lockout) 2: RUN/STOP, REV/FWD 3: RUN/STOP, REV/FWD (Line Start Lockout) 4: 3-wire 5: 3-wire (Line Start Lockout)	0	<input type="radio"/>	<input type="radio"/>	<input type="radio"/>	<input type="radio"/>	<input type="radio"/>	<input type="radio"/>
02-01	Multi-Function Input Command 1 (MI1) (it is Stop terminal for 3-wire operation)	0: no function	1	<input type="radio"/>	<input type="radio"/>	<input type="radio"/>	<input type="radio"/>	<input type="radio"/>	<input type="radio"/>
		1: multi-step speed command 1		<input type="radio"/>	<input type="radio"/>	<input type="radio"/>	<input type="radio"/>	<input type="radio"/>	<input type="radio"/>
02-02	Multi-Function Input Command 2 (MI2)	2: multi-step speed command 2	2	<input type="radio"/>	<input type="radio"/>	<input type="radio"/>	<input type="radio"/>	<input type="radio"/>	<input type="radio"/>
02-03	Multi-Function Input Command 3 (MI3)	3: multi-step speed command 3	3	<input type="radio"/>	<input type="radio"/>	<input type="radio"/>	<input type="radio"/>	<input type="radio"/>	<input type="radio"/>
02-04	Multi-Function Input Command 4 (MI4)	4: multi-step speed command 4	4	<input type="radio"/>	<input type="radio"/>	<input type="radio"/>	<input type="radio"/>	<input type="radio"/>	<input type="radio"/>
02-05	Multi-Function Input Command 5 (MI5)	5: Reset	0	<input type="radio"/>	<input type="radio"/>	<input type="radio"/>	<input type="radio"/>	<input type="radio"/>	<input type="radio"/>
02-06	Multi-Function Input Command 6 (MI6)	6: JOG command	0	<input type="radio"/>	<input type="radio"/>	<input type="radio"/>	<input type="radio"/>	<input type="radio"/>	<input type="radio"/>
02-07	Multi-Function Input Command 7 (MI7)	7: acceleration/ deceleration speed inhibit	0	<input type="radio"/>	<input type="radio"/>	<input type="radio"/>	<input type="radio"/>	<input type="radio"/>	<input type="radio"/>
02-08	Multi-Function Input Command 8 (MI8)	8: the 1st, 2nd acceleration/deceleration time selection	40	<input type="radio"/>	<input type="radio"/>	<input type="radio"/>	<input type="radio"/>	<input type="radio"/>	<input type="radio"/>
		9: the 3rd, 4th acceleration/deceleration time selection		<input type="radio"/>	<input type="radio"/>	<input type="radio"/>	<input type="radio"/>	<input type="radio"/>	<input type="radio"/>
		10: EF input (07-28)		<input type="radio"/>	<input type="radio"/>	<input type="radio"/>	<input type="radio"/>	<input type="radio"/>	<input type="radio"/>
		11: Reserved		<input type="radio"/>	<input type="radio"/>	<input type="radio"/>	<input type="radio"/>	<input type="radio"/>	<input type="radio"/>
		12: Stop output		<input type="radio"/>	<input type="radio"/>	<input type="radio"/>	<input type="radio"/>	<input type="radio"/>	<input type="radio"/>
		13~14: Reserved		<input type="radio"/>	<input type="radio"/>	<input type="radio"/>	<input type="radio"/>	<input type="radio"/>	<input type="radio"/>
		15: operation speed command form AUI1		<input type="radio"/>	<input type="radio"/>	<input type="radio"/>	<input type="radio"/>	<input type="radio"/>	<input type="radio"/>
		16: Reserved		<input type="radio"/>	<input type="radio"/>	<input type="radio"/>	<input type="radio"/>	<input type="radio"/>	<input type="radio"/>
		17: Operation speed command form AUI2		<input type="radio"/>	<input type="radio"/>	<input type="radio"/>	<input type="radio"/>	<input type="radio"/>	<input type="radio"/>
		18: Emergency Stop (07-28)		<input type="radio"/>	<input type="radio"/>	<input type="radio"/>	<input type="radio"/>	<input type="radio"/>	<input type="radio"/>
		19~23: Reserved		<input type="radio"/>	<input type="radio"/>	<input type="radio"/>	<input type="radio"/>	<input type="radio"/>	<input type="radio"/>
		24: FWD JOG command		<input type="radio"/>	<input type="radio"/>	<input type="radio"/>	<input type="radio"/>	<input type="radio"/>	<input type="radio"/>
		25: REV JOG command		<input type="radio"/>	<input type="radio"/>	<input type="radio"/>	<input type="radio"/>	<input type="radio"/>	<input type="radio"/>
		26: Reserved		<input type="radio"/>	<input type="radio"/>	<input type="radio"/>	<input type="radio"/>	<input type="radio"/>	<input type="radio"/>
		27: ASR1/ASR2 selection		<input type="radio"/>	<input type="radio"/>	<input type="radio"/>	<input type="radio"/>	<input type="radio"/>	<input type="radio"/>
		28: Emergency stop (EF1) (Motor coasts to stop)		<input type="radio"/>	<input type="radio"/>	<input type="radio"/>	<input type="radio"/>	<input type="radio"/>	<input type="radio"/>
		29-30: Reserved		<input type="radio"/>	<input type="radio"/>	<input type="radio"/>	<input type="radio"/>	<input type="radio"/>	<input type="radio"/>
		31: High torque bias (by Pr.07-21)		<input type="radio"/>	<input type="radio"/>	<input type="radio"/>	<input type="radio"/>	<input type="radio"/>	<input type="radio"/>
		32: Middle torque bias (by Pr.07-22)		<input type="radio"/>	<input type="radio"/>	<input type="radio"/>	<input type="radio"/>	<input type="radio"/>	<input type="radio"/>
		33: Low torque bias (by Pr.07-23)		<input type="radio"/>	<input type="radio"/>	<input type="radio"/>	<input type="radio"/>	<input type="radio"/>	<input type="radio"/>
		34-37: Reserved		<input type="radio"/>	<input type="radio"/>	<input type="radio"/>	<input type="radio"/>	<input type="radio"/>	<input type="radio"/>
38: Disable write EEPROM function	<input type="radio"/>	<input type="radio"/>	<input type="radio"/>	<input type="radio"/>	<input type="radio"/>	<input type="radio"/>			
39: Torque command direction	<input type="radio"/>	<input type="radio"/>	<input type="radio"/>	<input type="radio"/>	<input type="radio"/>	<input type="radio"/>			
40: Enable drive function	<input type="radio"/>	<input type="radio"/>	<input type="radio"/>	<input type="radio"/>	<input type="radio"/>	<input type="radio"/>			
41: Detection of magnetic contactor	<input type="radio"/>	<input type="radio"/>	<input type="radio"/>	<input type="radio"/>	<input type="radio"/>	<input type="radio"/>			
42: Mechanical brake 1	<input type="radio"/>	<input type="radio"/>	<input type="radio"/>	<input type="radio"/>	<input type="radio"/>	<input type="radio"/>			
43: EPS function	<input type="radio"/>	<input type="radio"/>	<input type="radio"/>	<input type="radio"/>	<input type="radio"/>	<input type="radio"/>			

		44: Mechanical brake 2		<input type="checkbox"/>	<input type="checkbox"/>	<input type="checkbox"/>	<input type="checkbox"/>	<input type="checkbox"/>	<input type="checkbox"/>
		45~51: Direct docking mode only ◆							
↗	02-09	Digital Input Response Time	0.001~ 30.000sec.	0.005	<input type="checkbox"/>	<input type="checkbox"/>	<input type="checkbox"/>	<input type="checkbox"/>	<input type="checkbox"/>
↗	02-10	Digital Input Operation Direction	0~65535	0	<input type="checkbox"/>	<input type="checkbox"/>	<input type="checkbox"/>	<input type="checkbox"/>	<input type="checkbox"/>
↗	02-11	Multi-function Output 1: RA, RB, RC (Relay1)	0: No function	11	<input type="checkbox"/>	<input type="checkbox"/>	<input type="checkbox"/>	<input type="checkbox"/>	<input type="checkbox"/>
			1: Operation indication		<input type="checkbox"/>	<input type="checkbox"/>	<input type="checkbox"/>	<input type="checkbox"/>	<input type="checkbox"/>
↗	02-12	Multi-function Output 2: MRA, MRB, MRC (Relay2)	2: Operation speed attained	1	<input type="checkbox"/>	<input type="checkbox"/>	<input type="checkbox"/>	<input type="checkbox"/>	<input type="checkbox"/>
			3: Desired frequency attained 1 (Pr.02-25)		<input type="checkbox"/>	<input type="checkbox"/>	<input type="checkbox"/>	<input type="checkbox"/>	<input type="checkbox"/>
↗	02-13	Multi-function Output 3: R1A, R12C (Relay3)	4: Desired frequency attained 2 (Pr.02-27)	0	<input type="checkbox"/>	<input type="checkbox"/>	<input type="checkbox"/>	<input type="checkbox"/>	<input type="checkbox"/>
↗	02-14	Multi-function Output 4: R2A, R12C (Relay4)	5: Zero speed (frequency command)	0	<input type="checkbox"/>	<input type="checkbox"/>	<input type="checkbox"/>	<input type="checkbox"/>	<input type="checkbox"/>
↗	02-15	Multi-function Output 5: (MO1)	6: Zero speed with stop (frequency command)	0	<input type="checkbox"/>	<input type="checkbox"/>	<input type="checkbox"/>	<input type="checkbox"/>	<input type="checkbox"/>
↗	02-16	Multi-function Output 6: (MO2)	7: Over torque (OT1) (Pr.06-05~06-07)	0	<input type="checkbox"/>	<input type="checkbox"/>	<input type="checkbox"/>	<input type="checkbox"/>	<input type="checkbox"/>
			8: Over torque (OT2) (Pr.06-08~06-10)	0	<input type="checkbox"/>	<input type="checkbox"/>	<input type="checkbox"/>	<input type="checkbox"/>	<input type="checkbox"/>
			9: Drive ready	0	<input type="checkbox"/>	<input type="checkbox"/>	<input type="checkbox"/>	<input type="checkbox"/>	<input type="checkbox"/>
			10: User-defined Low-voltage Detection (LV)	0	<input type="checkbox"/>	<input type="checkbox"/>	<input type="checkbox"/>	<input type="checkbox"/>	<input type="checkbox"/>
			11: Malfunction indication	0	<input type="checkbox"/>	<input type="checkbox"/>	<input type="checkbox"/>	<input type="checkbox"/>	<input type="checkbox"/>
			12: Mechanical brake release (Pr.02-29, Pr.02-30)	0	<input type="checkbox"/>	<input type="checkbox"/>	<input type="checkbox"/>	<input type="checkbox"/>	<input type="checkbox"/>
			13: Overheat (Pr.06-14)	0	<input type="checkbox"/>	<input type="checkbox"/>	<input type="checkbox"/>	<input type="checkbox"/>	<input type="checkbox"/>
			14: Brake chopper signal		<input type="checkbox"/>	<input type="checkbox"/>	<input type="checkbox"/>	<input type="checkbox"/>	<input type="checkbox"/>
			15: Motor-controlled magnetic contactor output		<input type="checkbox"/>	<input type="checkbox"/>	<input type="checkbox"/>	<input type="checkbox"/>	<input type="checkbox"/>
			16: Slip error (oSL)		<input type="checkbox"/>	<input type="checkbox"/>	<input type="checkbox"/>	<input type="checkbox"/>	<input type="checkbox"/>
			17: Malfunction indication 1	0	<input type="checkbox"/>	<input type="checkbox"/>	<input type="checkbox"/>	<input type="checkbox"/>	<input type="checkbox"/>
			18: Reserved						
			19: Brake chopper output error		<input type="checkbox"/>	<input type="checkbox"/>	<input type="checkbox"/>	<input type="checkbox"/>	<input type="checkbox"/>
			20: Warning output		<input type="checkbox"/>	<input type="checkbox"/>	<input type="checkbox"/>	<input type="checkbox"/>	<input type="checkbox"/>
			21: Over voltage warning		<input type="checkbox"/>	<input type="checkbox"/>	<input type="checkbox"/>	<input type="checkbox"/>	<input type="checkbox"/>
			22: Over-current stall prevention warning		<input type="checkbox"/>	<input type="checkbox"/>	<input type="checkbox"/>		
			23: Over-voltage stall prevention warning		<input type="checkbox"/>	<input type="checkbox"/>	<input type="checkbox"/>	<input type="checkbox"/>	<input type="checkbox"/>
			24: Operation mode indication (Pr.00-15≠0 and PU LED on KPC-CC01 is off)		<input type="checkbox"/>	<input type="checkbox"/>	<input type="checkbox"/>	<input type="checkbox"/>	<input type="checkbox"/>
			25: Forward command		<input type="checkbox"/>	<input type="checkbox"/>	<input type="checkbox"/>	<input type="checkbox"/>	<input type="checkbox"/>
			26: Reverse command		<input type="checkbox"/>	<input type="checkbox"/>	<input type="checkbox"/>	<input type="checkbox"/>	<input type="checkbox"/>
			27: Output when current >= Pr.02-33		<input type="checkbox"/>	<input type="checkbox"/>	<input type="checkbox"/>	<input type="checkbox"/>	<input type="checkbox"/>
			28: Output when current < Pr.02-33		<input type="checkbox"/>	<input type="checkbox"/>	<input type="checkbox"/>	<input type="checkbox"/>	<input type="checkbox"/>
			29: Output when frequency >= Pr.02-34		<input type="checkbox"/>	<input type="checkbox"/>	<input type="checkbox"/>	<input type="checkbox"/>	<input type="checkbox"/>
			30: Output when frequency < Pr.02-34		<input type="checkbox"/>	<input type="checkbox"/>	<input type="checkbox"/>	<input type="checkbox"/>	<input type="checkbox"/>
			31: Power generation direction and status verify		<input type="checkbox"/>	<input type="checkbox"/>	<input type="checkbox"/>	<input type="checkbox"/>	<input type="checkbox"/>
			32: Power generation direction		<input type="checkbox"/>	<input type="checkbox"/>	<input type="checkbox"/>	<input type="checkbox"/>	<input type="checkbox"/>
			33: Zero speed (actual output frequency)		<input type="checkbox"/>	<input type="checkbox"/>	<input type="checkbox"/>	<input type="checkbox"/>	<input type="checkbox"/>
			34: Zero speed with Stop (actual output frequency)		<input type="checkbox"/>	<input type="checkbox"/>	<input type="checkbox"/>	<input type="checkbox"/>	<input type="checkbox"/>
			35: Fault output option 1 (Pr.06-22)		<input type="checkbox"/>	<input type="checkbox"/>	<input type="checkbox"/>	<input type="checkbox"/>	<input type="checkbox"/>
			36: Fault output option 2 (Pr.06-23)		<input type="checkbox"/>	<input type="checkbox"/>	<input type="checkbox"/>	<input type="checkbox"/>	<input type="checkbox"/>
			37: Fault output option 3 (Pr.06-24)		<input type="checkbox"/>	<input type="checkbox"/>	<input type="checkbox"/>	<input type="checkbox"/>	<input type="checkbox"/>
			38: Fault output option 4 (Pr.06-25)		<input type="checkbox"/>	<input type="checkbox"/>	<input type="checkbox"/>	<input type="checkbox"/>	<input type="checkbox"/>
			39: Reserved						
			40: Speed attained (including zero speed)		<input type="checkbox"/>	<input type="checkbox"/>	<input type="checkbox"/>	<input type="checkbox"/>	<input type="checkbox"/>
			41: Reserved						
			42: STO Output Error						
			43~44: Direct docking mode only ◆						

		45: Reserved								
		46: Indicator of Retrying while a fault has occurred								
		47: Direct docking mode only ◆								
	02-17~ 02-22	Reserved								
✓	02-23	Multi-output Direction	0~65535	0	○	○	○	○	○	○
	02-24	Serial Start Signal Selection	0: by FWD/REV; 1: by Enable	0	○	○	○	○		○
✓	02-25	Desired Frequency Attained 1	0.00~400.00Hz	60.00/50.00	○	○	○	○		○
✓	02-26	The Width of the Desired Frequency Attained 1	0.00~400.00Hz	2.00	○	○	○	○		○
✓	02-27	Desired Frequency Attained 2	0.00~400.00Hz	60.00/50.00	○	○	○	○		○
✓	02-28	The Width of the Desired Frequency Attained 2	0.00~400.00Hz	2.00	○	○	○	○		○
	02-29	Brake Release Delay Time when Elevator Starts	0.000~65.000sec.	0.250	○	○	○	○	○	○
	02-30	Brake Engage Delay Time when Elevator Stops	0.000~65.000sec.	0.250	○	○	○	○	○	○
✓	02-31	Turn On Delay of Magnetic Contactor between Drive and Motor	0.010~65.000 sec.	0.200	○	○	○	○	○	○
✓	02-32	Turn Off Delay of Magnetic Contactor between Drive and Motor	0.010~65.000 sec.	0.200	○	○	○	○	○	○
✓	02-33	Output Current Level Setting for External Terminals	0~100%	0	○	○	○	○	○	○
✓	02-34	Output Boundary for External Terminals	0.00~+400.00Hz (it is motor speed when using with PG)	0.00	○	○	○	○	○	○
✓	02-35	Detection Time of Mechanical Brake	0.00~10.00sec.	0.00	○	○	○	○	○	○
✓	02-36	Detection Time of Contactor	0.00~10.00sec.	0.00	○	○	○	○	○	○
	02-37	Check Torque Output Function	0: Enable 1: Disable	0	○	○	○	○	○	○

03 Analog Input/ Output Parameters

Pr.	Explanation	Setting Range	Factory Setting	VF	VFG	SVC	FOCPG	TQCPG	FOCPM	
✓ 03-00	Analog Input 1 (AUI1)	0: No function	1	<input type="radio"/>	<input type="radio"/>	<input type="radio"/>	<input type="radio"/>	<input type="radio"/>	<input type="radio"/>	
✓ 03-01	Reserved	1: Frequency command (torque limit under TQR control mode)								
✓ 03-02	Analog Input 3 (AUI2)	2: Torque command (torque limit under speed mode)	0					<input type="radio"/>		
		3: Preload Input		<input type="radio"/>	<input type="radio"/>	<input type="radio"/>	<input type="radio"/>	<input type="radio"/>	<input type="radio"/>	
		4-5: Reserved								
		6: P.T.C. thermistor input value		<input type="radio"/>	<input type="radio"/>	<input type="radio"/>	<input type="radio"/>	<input type="radio"/>	<input type="radio"/>	
		7: Positive torque limit					<input type="radio"/>		<input type="radio"/>	
		8: Negative torque limit					<input type="radio"/>		<input type="radio"/>	
		9: Regenerative torque limit					<input type="radio"/>		<input type="radio"/>	
		10: Positive/negative torque limit					<input type="radio"/>		<input type="radio"/>	
✓ 03-03	Analog Input Bias 1 (AUI1)	-100.0~100.0%		0.0	<input type="radio"/>	<input type="radio"/>	<input type="radio"/>	<input type="radio"/>	<input type="radio"/>	<input type="radio"/>
✓ 03-04	Reserved									
✓ 03-05	Analog Input Bias 3 (AUI2)	-100.0~100.0%	0.0	<input type="radio"/>	<input type="radio"/>	<input type="radio"/>	<input type="radio"/>	<input type="radio"/>	<input type="radio"/>	
✓ 03-06	Positive/negative Bias Mode (AUI1)	0: Zero bias	0	<input type="radio"/>	<input type="radio"/>	<input type="radio"/>	<input type="radio"/>	<input type="radio"/>	<input type="radio"/>	
✓ 03-07	Reserved	1: Serve bias as the center, lower than bias=bias								
✓ 03-08	Positive/negative Bias Mode (AUI2)	2: Serve bias as the center, greater than bias=bias 3: The absolute value of the bias voltage while serving as the center (single polar) 4: Serve bias as the center (single polar)		0	<input type="radio"/>	<input type="radio"/>	<input type="radio"/>	<input type="radio"/>	<input type="radio"/>	<input type="radio"/>
✓ 03-09	Analog Input Gain 1 (AUI1)	0.0~500.0%	100.0	<input type="radio"/>	<input type="radio"/>	<input type="radio"/>	<input type="radio"/>	<input type="radio"/>	<input type="radio"/>	
✓ 03-10	Reserved									
✓ 03-11	Analog Input Gain 3 (AUI2)	0.0~500.0%	100.0	<input type="radio"/>	<input type="radio"/>	<input type="radio"/>	<input type="radio"/>	<input type="radio"/>	<input type="radio"/>	
✓ 03-12	Analog Input Delay Time (AUI1)	0.00~2.00sec.	0.01	<input type="radio"/>	<input type="radio"/>	<input type="radio"/>	<input type="radio"/>	<input type="radio"/>	<input type="radio"/>	
✓ 03-13	Reserved									
✓ 03-14	Analog Input Filter Time (AUI2)	0.00~2.00sec.	0.01	<input type="radio"/>	<input type="radio"/>	<input type="radio"/>	<input type="radio"/>	<input type="radio"/>	<input type="radio"/>	
✓ 03-15	Reserved									
✓ 03-16	Reserved									
✓ 03-17	Analog Output Selection 1	0: Output frequency (Hz)	0	<input type="radio"/>	<input type="radio"/>	<input type="radio"/>	<input type="radio"/>	<input type="radio"/>	<input type="radio"/>	
		1: Frequency command (Hz)		<input type="radio"/>	<input type="radio"/>	<input type="radio"/>	<input type="radio"/>	<input type="radio"/>	<input type="radio"/>	
		2: Motor speed (RPM)		<input type="radio"/>	<input type="radio"/>	<input type="radio"/>	<input type="radio"/>	<input type="radio"/>	<input type="radio"/>	
		3: Output current (rms)		<input type="radio"/>	<input type="radio"/>	<input type="radio"/>	<input type="radio"/>	<input type="radio"/>	<input type="radio"/>	
		4: Output voltage		<input type="radio"/>	<input type="radio"/>	<input type="radio"/>	<input type="radio"/>	<input type="radio"/>	<input type="radio"/>	
		5: DC Bus Voltage		<input type="radio"/>	<input type="radio"/>	<input type="radio"/>	<input type="radio"/>	<input type="radio"/>	<input type="radio"/>	
		6: Power factor angle		<input type="radio"/>	<input type="radio"/>	<input type="radio"/>	<input type="radio"/>	<input type="radio"/>	<input type="radio"/>	
		7: Power factor		<input type="radio"/>	<input type="radio"/>	<input type="radio"/>	<input type="radio"/>	<input type="radio"/>	<input type="radio"/>	
		8: Output torque		<input type="radio"/>	<input type="radio"/>	<input type="radio"/>	<input type="radio"/>	<input type="radio"/>	<input type="radio"/>	
		9: AUI1		<input type="radio"/>	<input type="radio"/>	<input type="radio"/>	<input type="radio"/>	<input type="radio"/>	<input type="radio"/>	
		10: Reserved								
		11: AUI2		<input type="radio"/>	<input type="radio"/>	<input type="radio"/>	<input type="radio"/>	<input type="radio"/>	<input type="radio"/>	
		12: q-axis current		<input type="radio"/>	<input type="radio"/>	<input type="radio"/>	<input type="radio"/>	<input type="radio"/>	<input type="radio"/>	
		13: q-axis feedback value		<input type="radio"/>	<input type="radio"/>	<input type="radio"/>	<input type="radio"/>	<input type="radio"/>	<input type="radio"/>	
		14: d-axis current		<input type="radio"/>	<input type="radio"/>	<input type="radio"/>	<input type="radio"/>	<input type="radio"/>	<input type="radio"/>	
		15: d-axis feedback value		<input type="radio"/>	<input type="radio"/>	<input type="radio"/>	<input type="radio"/>	<input type="radio"/>	<input type="radio"/>	
		16: q-axis voltage		<input type="radio"/>	<input type="radio"/>	<input type="radio"/>	<input type="radio"/>	<input type="radio"/>	<input type="radio"/>	
		17: d-axis voltage	<input type="radio"/>	<input type="radio"/>	<input type="radio"/>	<input type="radio"/>	<input type="radio"/>	<input type="radio"/>		

		18: Torque command		<input type="radio"/>	<input type="radio"/>	<input type="radio"/>	<input type="radio"/>	<input type="radio"/>	<input type="radio"/>
		19-20: Reserved							
		21: Power Output		<input type="radio"/>	<input type="radio"/>	<input type="radio"/>	<input type="radio"/>	<input type="radio"/>	<input type="radio"/>
↗	03-18	Analog Output Gain 1	0~200.0%	100.0	<input type="radio"/>	<input type="radio"/>	<input type="radio"/>	<input type="radio"/>	<input type="radio"/>
↗	03-19	Analog Output Value in REV Direction 1	0: Absolute value in REV direction 1: Output 0V in REV direction 2: Enable output voltage in REV direction	0	<input type="radio"/>	<input type="radio"/>	<input type="radio"/>	<input type="radio"/>	<input type="radio"/>
↗	03-20	Analog Output Selection 2	0: Output frequency (Hz)	0	<input type="radio"/>	<input type="radio"/>	<input type="radio"/>	<input type="radio"/>	<input type="radio"/>
		1: Frequency command (Hz)			<input type="radio"/>	<input type="radio"/>	<input type="radio"/>	<input type="radio"/>	<input type="radio"/>
		2: Motor speed (RPM)			<input type="radio"/>	<input type="radio"/>	<input type="radio"/>	<input type="radio"/>	<input type="radio"/>
		3: Output current (rms)			<input type="radio"/>	<input type="radio"/>	<input type="radio"/>	<input type="radio"/>	<input type="radio"/>
		4: Output voltage			<input type="radio"/>	<input type="radio"/>	<input type="radio"/>	<input type="radio"/>	<input type="radio"/>
		5: DC Bus Voltage			<input type="radio"/>	<input type="radio"/>	<input type="radio"/>	<input type="radio"/>	<input type="radio"/>
		6: Power factor			<input type="radio"/>	<input type="radio"/>	<input type="radio"/>	<input type="radio"/>	<input type="radio"/>
		7: Power			<input type="radio"/>	<input type="radio"/>	<input type="radio"/>	<input type="radio"/>	<input type="radio"/>
		8: Output torque			<input type="radio"/>	<input type="radio"/>	<input type="radio"/>	<input type="radio"/>	<input type="radio"/>
		9: AUI1			<input type="radio"/>	<input type="radio"/>	<input type="radio"/>	<input type="radio"/>	<input type="radio"/>
		10: Reserved							
		11: AUI2			<input type="radio"/>	<input type="radio"/>	<input type="radio"/>	<input type="radio"/>	<input type="radio"/>
		12: q-axis current			<input type="radio"/>	<input type="radio"/>	<input type="radio"/>	<input type="radio"/>	<input type="radio"/>
		13: q-axis feedback value			<input type="radio"/>	<input type="radio"/>	<input type="radio"/>	<input type="radio"/>	<input type="radio"/>
		14: d-axis current			<input type="radio"/>	<input type="radio"/>	<input type="radio"/>	<input type="radio"/>	<input type="radio"/>
		15: d-axis feedback value			<input type="radio"/>	<input type="radio"/>	<input type="radio"/>	<input type="radio"/>	<input type="radio"/>
		16: q-axis voltage			<input type="radio"/>	<input type="radio"/>	<input type="radio"/>	<input type="radio"/>	<input type="radio"/>
		17: d-axis voltage			<input type="radio"/>	<input type="radio"/>	<input type="radio"/>	<input type="radio"/>	<input type="radio"/>
		18: Torque command			<input type="radio"/>	<input type="radio"/>	<input type="radio"/>	<input type="radio"/>	<input type="radio"/>
		19-20: Reserved							
		21: Power Output			<input type="radio"/>	<input type="radio"/>	<input type="radio"/>	<input type="radio"/>	<input type="radio"/>
↗	03-21	Analog Output Gain 2	0~200.0%	100.0	<input type="radio"/>	<input type="radio"/>	<input type="radio"/>	<input type="radio"/>	<input type="radio"/>
↗	03-22	Analog Output Value in REV Direction 2	0: Absolute value in REV direction 1: Output 0V in REV direction 2: Enable output voltage in REV direction	0	<input type="radio"/>	<input type="radio"/>	<input type="radio"/>	<input type="radio"/>	<input type="radio"/>
	03-23	Analog Input Type (AUI1)	0: Bipolar (±10V) 1: Unipolar (0-10V)	0	<input type="radio"/>	<input type="radio"/>	<input type="radio"/>	<input type="radio"/>	<input type="radio"/>
	03-24	Analog Input Type (AUI2)	0: Bipolar (±10V) 1: Unipolar (0-10V)	0	<input type="radio"/>	<input type="radio"/>	<input type="radio"/>	<input type="radio"/>	<input type="radio"/>

04 Multi-Step Speed Parameters

Pr.	Explanation	Setting Range	Factory Setting	VF	VFG	SVC	FOCPG	TQCPG	FOCPM
				<input type="radio"/>	<input type="radio"/>	<input type="radio"/>	<input type="radio"/>	<input type="radio"/>	<input type="radio"/>
✓ 04-00	Zero Step Speed Frequency	0.00~400.00Hz	0.00	<input type="radio"/>	<input type="radio"/>	<input type="radio"/>	<input type="radio"/>	<input type="radio"/>	<input type="radio"/>
✓ 04-01	1st Step Speed Frequency	0.00~400.00Hz	0.00	<input type="radio"/>	<input type="radio"/>	<input type="radio"/>	<input type="radio"/>	<input type="radio"/>	<input type="radio"/>
✓ 04-02	2nd Step Speed Frequency	0.00~400.00Hz	0.00	<input type="radio"/>	<input type="radio"/>	<input type="radio"/>	<input type="radio"/>	<input type="radio"/>	<input type="radio"/>
✓ 04-03	3rd Step Speed Frequency	0.00~400.00Hz	0.00	<input type="radio"/>	<input type="radio"/>	<input type="radio"/>	<input type="radio"/>	<input type="radio"/>	<input type="radio"/>
✓ 04-04	4th Step Speed Frequency	0.00~400.00Hz	0.00	<input type="radio"/>	<input type="radio"/>	<input type="radio"/>	<input type="radio"/>	<input type="radio"/>	<input type="radio"/>
✓ 04-05	5th Step Speed Frequency	0.00~400.00Hz	0.00	<input type="radio"/>	<input type="radio"/>	<input type="radio"/>	<input type="radio"/>	<input type="radio"/>	<input type="radio"/>
✓ 04-06	6th Step Speed Frequency	0.00~400.00Hz	0.00	<input type="radio"/>	<input type="radio"/>	<input type="radio"/>	<input type="radio"/>	<input type="radio"/>	<input type="radio"/>
✓ 04-07	7th Step Speed Frequency	0.00~400.00Hz	0.00	<input type="radio"/>	<input type="radio"/>	<input type="radio"/>	<input type="radio"/>	<input type="radio"/>	<input type="radio"/>
✓ 04-08	8th Step Speed Frequency	0.00~400.00Hz	0.00	<input type="radio"/>	<input type="radio"/>	<input type="radio"/>	<input type="radio"/>	<input type="radio"/>	<input type="radio"/>
✓ 04-09	9th Step Speed Frequency	0.00~400.00Hz	0.00	<input type="radio"/>	<input type="radio"/>	<input type="radio"/>	<input type="radio"/>	<input type="radio"/>	<input type="radio"/>
✓ 04-10	10th Step Speed Frequency	0.00~400.00Hz	0.00	<input type="radio"/>	<input type="radio"/>	<input type="radio"/>	<input type="radio"/>	<input type="radio"/>	<input type="radio"/>
✓ 04-11	11th Step Speed Frequency	0.00~400.00Hz	0.00	<input type="radio"/>	<input type="radio"/>	<input type="radio"/>	<input type="radio"/>	<input type="radio"/>	<input type="radio"/>
✓ 04-12	12th Step Speed Frequency	0.00~400.00Hz	0.00	<input type="radio"/>	<input type="radio"/>	<input type="radio"/>	<input type="radio"/>	<input type="radio"/>	<input type="radio"/>
✓ 04-13	13th Step Speed Frequency	0.00~400.00Hz	0.00	<input type="radio"/>	<input type="radio"/>	<input type="radio"/>	<input type="radio"/>	<input type="radio"/>	<input type="radio"/>
✓ 04-14	14th Step Speed Frequency	0.00~400.00Hz	0.00	<input type="radio"/>	<input type="radio"/>	<input type="radio"/>	<input type="radio"/>	<input type="radio"/>	<input type="radio"/>
✓ 04-15	15th Step Speed Frequency	0.00~400.00Hz	0.00	<input type="radio"/>	<input type="radio"/>	<input type="radio"/>	<input type="radio"/>	<input type="radio"/>	<input type="radio"/>
04-16 ~ 04-99	Direct docking mode only ◆								

05 IM Parameters

Pr.	Explanation	Setting Range	Factory Setting	VF	VFP	SVC	FOCPG	TQCPG	FOCPM
05-00	Motor Auto Tuning	0: No function 1: Rolling test (Rs, Rr, Lm, Lx, no-load current) 2: Static test	0	<input type="radio"/>					
05-01	Full-load Current of Motor	(40~120%) *00-01 Amps	###	<input type="radio"/>	<input type="radio"/>	<input type="radio"/>	<input type="radio"/>	<input type="radio"/>	
05-02	Rated power of Motor	0.00~655.35kW	###			<input type="radio"/>	<input type="radio"/>	<input type="radio"/>	
05-03	Rated speed of Motor (rpm)	0~65535	1710		<input type="radio"/>	<input type="radio"/>	<input type="radio"/>	<input type="radio"/>	
05-04	Number of Motor Poles	2~48	4	<input type="radio"/>	<input type="radio"/>	<input type="radio"/>	<input type="radio"/>	<input type="radio"/>	
05-05	No-load Current of Motor	0~ Pr05-01 <factory setting>	###		<input type="radio"/>	<input type="radio"/>	<input type="radio"/>	<input type="radio"/>	
05-06	Rs of Motor	0.000~65.535Ω	0.000			<input type="radio"/>	<input type="radio"/>	<input type="radio"/>	
05-07	Rr of Motor	0.000~65.535Ω	0.000			<input type="radio"/>	<input type="radio"/>	<input type="radio"/>	
05-08	Lm of Motor	0.0~6553.5mH	0.0			<input type="radio"/>	<input type="radio"/>	<input type="radio"/>	
05-09	Lx of Motor	0.0~6553.5mH	0.0			<input type="radio"/>	<input type="radio"/>	<input type="radio"/>	
✓ 05-10	Torque Compensation Time Constant	0.001~10.000sec.	0.020			<input type="radio"/>			
✓ 05-11	Slip Compensation Time Constant	0.001~10.000sec.	0.100			<input type="radio"/>			
✓ 05-12	Torque Compensation Gain	0~10	0	<input type="radio"/>	<input type="radio"/>				
✓ 05-13	Slip Compensation Gain	0.00~10.00	0.00			<input type="radio"/>			
✓ 05-14	Slip Deviation Level	0~1000% (0: disable)	0		<input type="radio"/>	<input type="radio"/>	<input type="radio"/>		
✓ 05-15	Detection Time of Slip Deviation	0.0~10.0sec.	1.0		<input type="radio"/>	<input type="radio"/>	<input type="radio"/>		
✓ 05-16	Over Slip Treatment	0: Warn and keep operation 1: Fault and ramp to stop 2: Fault and coast to stop	0		<input type="radio"/>	<input type="radio"/>	<input type="radio"/>		
✓ 05-17	Hunting Gain	0~10000 (0: disable)	2000	<input type="radio"/>	<input type="radio"/>	<input type="radio"/>			
05-18	Accumulative Motor Operation Time (Min.)	00~1439	00	<input type="radio"/>	<input type="radio"/>	<input type="radio"/>	<input type="radio"/>	<input type="radio"/>	<input type="radio"/>
05-19	Accumulative Motor Operation Time (day)	00~65535	00	<input type="radio"/>	<input type="radio"/>	<input type="radio"/>	<input type="radio"/>	<input type="radio"/>	<input type="radio"/>
✓ 05-20	Core Loss Compensation	0~250%	10			<input type="radio"/>			
05-21	Accumulative Drive Power-on Time (Min.)	00~1439	00	<input type="radio"/>	<input type="radio"/>	<input type="radio"/>	<input type="radio"/>	<input type="radio"/>	<input type="radio"/>
05-22	Accumulative Drive Power-on Time (day)	00~65535	00	<input type="radio"/>	<input type="radio"/>	<input type="radio"/>	<input type="radio"/>	<input type="radio"/>	<input type="radio"/>
05-23	Slip compensation gain % (electricity generating mode)	0.0~100.0 %	0.0	<input type="radio"/>		<input type="radio"/>			
05-24	Slip compensation gain % (electric mode)	0.0~100.0 %	0.0	<input type="radio"/>		<input type="radio"/>			

06 Protection Parameters

Pr.	Explanation	Setting Range	Factory Setting	VF	VFP	SVC	FOCPG	TQCPG	FOCPM
				<input type="checkbox"/>	<input type="checkbox"/>	<input type="checkbox"/>	<input type="checkbox"/>	<input type="checkbox"/>	<input type="checkbox"/>
06-00	Low Voltage Level	160.0~220.0Vdc 320.0~440.0Vdc	180.0 360.0	<input type="checkbox"/>	<input type="checkbox"/>	<input type="checkbox"/>	<input type="checkbox"/>	<input type="checkbox"/>	<input type="checkbox"/>
06-01	Phase-loss protection	0: Warm and keep operation 1: Fault and ramp to stop 2: Fault and coast to stop	2	<input type="checkbox"/>	<input type="checkbox"/>	<input type="checkbox"/>	<input type="checkbox"/>	<input type="checkbox"/>	<input type="checkbox"/>
06-02	Over-Current Stall Prevention during Acceleration	00: disable 00~250% (rated current of the motor drive)	00	<input type="checkbox"/>	<input type="checkbox"/>	<input type="checkbox"/>			
06-03	Over-current Stall Prevention during Operation	00: disable 00~250% (rated current of the motor drive)	00	<input type="checkbox"/>	<input type="checkbox"/>	<input type="checkbox"/>			
06-04	Accel. / Decel. Time Selection of Stall Prevention at constant speed	0: by current accel/decel time 1: by the 1st accel/decel time 2: by the 2nd accel/decel time 3: by the 3rd accel/decel time 4: by the 4th accel/decel time 5: by auto accel/decel time	0	<input type="checkbox"/>	<input type="checkbox"/>	<input type="checkbox"/>			
06-05	Over-torque Detection Selection (OT1)	0: disable 1: over-torque detection during constant speed operation, continue to operate after detection 2: over-torque detection during constant speed operation, stop operation after detection 3: over-torque detection during operation, continue to operate after detection 4: over-torque detection during operation, stop operation after detection	0	<input type="checkbox"/>	<input type="checkbox"/>	<input type="checkbox"/>	<input type="checkbox"/>	<input type="checkbox"/>	<input type="checkbox"/>
06-06	Over-torque Detection Level (OT1)	10~250% (rated current of the motor drive)	150	<input type="checkbox"/>	<input type="checkbox"/>	<input type="checkbox"/>	<input type="checkbox"/>	<input type="checkbox"/>	<input type="checkbox"/>
06-07	Over-torque Detection Time (OT1)	0.1~60.0sec.	0.1	<input type="checkbox"/>	<input type="checkbox"/>	<input type="checkbox"/>	<input type="checkbox"/>	<input type="checkbox"/>	<input type="checkbox"/>
06-08	Over-torque Detection Selection (OT2)	0: disable 1: over-torque detection during constant speed operation, continue to operate after detection 2: over-torque detection during constant speed operation, stop operation after detection 3: over-torque detection during operation, continue to operate after detection 4: over-torque detection during operation, stop operation after detection	0	<input type="checkbox"/>	<input type="checkbox"/>	<input type="checkbox"/>	<input type="checkbox"/>	<input type="checkbox"/>	<input type="checkbox"/>
06-09	Over-torque Detection Level (OT2)	10~250% (rated current of the motor drive)	150	<input type="checkbox"/>	<input type="checkbox"/>	<input type="checkbox"/>	<input type="checkbox"/>	<input type="checkbox"/>	<input type="checkbox"/>
06-10	Over-torque Detection Time (OT2)	0.1~60.0sec.	0.1	<input type="checkbox"/>	<input type="checkbox"/>	<input type="checkbox"/>	<input type="checkbox"/>	<input type="checkbox"/>	<input type="checkbox"/>
06-11	Current Limit	0~250% (rated current of the motor drive)	200				<input type="checkbox"/>	<input type="checkbox"/>	<input type="checkbox"/>
06-12	Electronic Thermal Relay Selection	0: Inverter motor 1: Standard motor 2: Disable	2	<input type="checkbox"/>	<input type="checkbox"/>	<input type="checkbox"/>	<input type="checkbox"/>	<input type="checkbox"/>	<input type="checkbox"/>
06-13	Electronic Thermal Characteristic	30.0~600.0sec.	60.0	<input type="checkbox"/>	<input type="checkbox"/>	<input type="checkbox"/>	<input type="checkbox"/>	<input type="checkbox"/>	<input type="checkbox"/>
06-14	Heat Sink Over-heat (OH) Warning	0.0~110.0°C	90.0	<input type="checkbox"/>	<input type="checkbox"/>	<input type="checkbox"/>	<input type="checkbox"/>	<input type="checkbox"/>	<input type="checkbox"/>
06-15	Stall Prevention Limit Level	0~100% (Refer to Pr06-02, Pr06-03)	50	<input type="checkbox"/>	<input type="checkbox"/>	<input type="checkbox"/>			
06-16	Present Fault Record	0: No fault	0	<input type="checkbox"/>	<input type="checkbox"/>	<input type="checkbox"/>	<input type="checkbox"/>	<input type="checkbox"/>	<input type="checkbox"/>

06-17	Second Most Recent Fault Record	1: Over-current during acceleration (ocA)	0	<input type="radio"/>	<input type="radio"/>	<input type="radio"/>	<input type="radio"/>	<input type="radio"/>	<input type="radio"/>
06-18	Third Most Recent Fault Record	2: Over-current during deceleration (ocd)	0	<input type="radio"/>	<input type="radio"/>	<input type="radio"/>	<input type="radio"/>	<input type="radio"/>	<input type="radio"/>
06-19	Fourth Most Recent Fault Record	3: Over-current during constant speed (ocn)	0	<input type="radio"/>	<input type="radio"/>	<input type="radio"/>	<input type="radio"/>	<input type="radio"/>	<input type="radio"/>
06-20	Fifth Most Recent Fault Record	4: Ground fault (GFF)	0	<input type="radio"/>	<input type="radio"/>	<input type="radio"/>	<input type="radio"/>	<input type="radio"/>	<input type="radio"/>
06-21	Sixth Most Recent Fault Record	5: IGBT short-circuit (occ) 6: Over-current at stop (ocS) 7: Over-voltage during acceleration (ovA) 8: Over-voltage during deceleration (ovd) 9: Over-voltage during constant speed (ovn) 10: Over-voltage at stop (ovS) 11: Low-voltage during acceleration (LvA) 12: Low-voltage during deceleration (Lvd) 13: Low-voltage during constant speed (Lvn) 14: Low-voltage at stop (LvS) 15: Input Phase loss (PHL) 16: IGBT over-heat (oH1) 17: Bulk capacitors over-heat (oH2) 18: Abnormal IGBT temperature detected (tH1o) 19: Abnormal bulk capacitor temperature detected (tH2o) 20: Unusual cooling fan operation (FAn)	0	<input type="radio"/>	<input type="radio"/>	<input type="radio"/>	<input type="radio"/>	<input type="radio"/>	<input type="radio"/>
		21: oL (150%, 1 minute, motor drive overloaded) 22: Motor overloaded (EoL1) 23: Reserved 24: Motor PTC overheat (oH3) 25: Reserved 26: over-torque 1 (ot1) 27: over-torque 2 (ot2) 28: Reserved 29: Reserved 30: Memory write-in error (cF1) 31: Memory read-out error (cF2) 32: Isum current detection error (cd0) 33: U-phase current detection error (cd1) 34: V-phase current detection error (cd2) 35: W-phase current detection error (cd3) 36: CC current clamp hardware error (Hd0) 37: OC(overcurrent) hardware error (Hd1) 38: ov (overvoltage hardware error (Hd2) 39: GFF(ground fault)hardware error (Hd3) 40: Auto tuning error on motor's parameters (AUE) 41: Reserved 42: PG feedback error (PGF1) 43: PG feedback loss (PGF2) 44: PG feedback stall (PGF3) 45: PG slip error (PGF4) 46: Reserved 47: Reserved 48: Reserved 49: External fault input (EF) 50: Emergency stop by external terminals (EF1) 51: Reserved 52: Password error after three attempts (Pcod) 53: Reserved 54: Illegal communication command (cE01)							

		55: Illegal communication address (cE02) 56: Communication data length error (cE03) 57: Communication being written to a read-only address (cE04) 58: Modbus transmission time-out (cE10) 59: Keypad transmission time-out (cP10) 60: Brake chopper error (BF) 61-63: Reserved 64: Mechanical brake feedback error (MBF) 65: PGF5 hardware error 66: Magnetic contactor error (MCF) 67: Output phase loss (MPHL) 68: CAN Bus disconnected (CANF) 69 ~71: Reserved 72: Safety torque loss (STL1) 73: PGcd hardware error 74: PG absolute signal error (PGHL) 75: PG Z phase signal loss (PGAF) 76: Safety torque output stops (STO) 77: Safety torque loss 2 (STL2) 78: Safety torque loss 3 (STL3) *The definition of codes #69~#71 have been modified in v1.04. See Ch14 for more information.								
✓	06-22	Fault Output Option 1	0~65535 (refer to bit table for fault code)	0	<input type="radio"/>	<input type="radio"/>	<input type="radio"/>	<input type="radio"/>	<input type="radio"/>	<input type="radio"/>
✓	06-23	Fault Output Option 2	0~65535 (refer to bit table for fault code)	0	<input type="radio"/>	<input type="radio"/>	<input type="radio"/>	<input type="radio"/>	<input type="radio"/>	<input type="radio"/>
✓	06-24	Fault Output Option 3	0~65535 (refer to bit table for fault code)	0	<input type="radio"/>	<input type="radio"/>	<input type="radio"/>	<input type="radio"/>	<input type="radio"/>	<input type="radio"/>
✓	06-25	Fault Output Option 4	0~65535 (refer to bit table for fault code)	0	<input type="radio"/>	<input type="radio"/>	<input type="radio"/>	<input type="radio"/>	<input type="radio"/>	<input type="radio"/>
✓	06-26	PTC (Positive Temperature Coefficient) Detection Selection	0: Warn and keep operation 1: Fault and ramp to stop	0	<input type="radio"/>	<input type="radio"/>	<input type="radio"/>	<input type="radio"/>	<input type="radio"/>	<input type="radio"/>
✓	06-27	PTC Level	0.0~100.0%	50.0	<input type="radio"/>	<input type="radio"/>	<input type="radio"/>	<input type="radio"/>	<input type="radio"/>	<input type="radio"/>
✓	06-28	Filter Time for PTC Detection	0.00~10.00sec.	0.20	<input type="radio"/>	<input type="radio"/>	<input type="radio"/>	<input type="radio"/>	<input type="radio"/>	<input type="radio"/>
	06-29	Voltage of Emergency Power	24.0~375.0Vdc 48.0~750.0Vdc	24.0 48.0	<input type="radio"/>	<input type="radio"/>	<input type="radio"/>	<input type="radio"/>	<input type="radio"/>	<input type="radio"/>
✓	06-30	Setting Method of Fault Output	0: By settings of Pr.06-22~06-25 1: By the binary setting	0	<input type="radio"/>	<input type="radio"/>	<input type="radio"/>	<input type="radio"/>	<input type="radio"/>	<input type="radio"/>
	06-31	Phase Loss Detection of Drive Output at Start up (MPHL)	0: Disable 1: Enable	0	<input type="radio"/>	<input type="radio"/>	<input type="radio"/>	<input type="radio"/>	<input type="radio"/>	<input type="radio"/>
	06-32	Accumulative Drive Power-on Time at the First Fault (min.)	00~1439	00	<input type="radio"/>	<input type="radio"/>	<input type="radio"/>	<input type="radio"/>	<input type="radio"/>	<input type="radio"/>
	06-33	Accumulative Drive Power-on Time at the First Fault (day)	00-65535	00	<input type="radio"/>	<input type="radio"/>	<input type="radio"/>	<input type="radio"/>	<input type="radio"/>	<input type="radio"/>
	06-34	Accumulative Drive Power-on Time at the Second Fault (min.)	00~1439	00	<input type="radio"/>	<input type="radio"/>	<input type="radio"/>	<input type="radio"/>	<input type="radio"/>	<input type="radio"/>
	06-35	Accumulative Drive Power-on Time at the Second Fault (day)	00-65535	00	<input type="radio"/>	<input type="radio"/>	<input type="radio"/>	<input type="radio"/>	<input type="radio"/>	<input type="radio"/>
	06-36	Accumulative Drive Power-on Time at the Third Fault (min.)	00~1439	00	<input type="radio"/>	<input type="radio"/>	<input type="radio"/>	<input type="radio"/>	<input type="radio"/>	<input type="radio"/>
	06-37	Accumulative Drive Power-on Time at the Third Fault (day)	00-65535	00	<input type="radio"/>	<input type="radio"/>	<input type="radio"/>	<input type="radio"/>	<input type="radio"/>	<input type="radio"/>
	06-38	Accumulative Drive Power-on Time at the Fourth Fault (min.)	00~1439	00	<input type="radio"/>	<input type="radio"/>	<input type="radio"/>	<input type="radio"/>	<input type="radio"/>	<input type="radio"/>

	06-39	Accumulative Drive Power-on Time at the Fourth Fault (day)	00-65535	00	○	○	○	○	○	○
	06-40	Accumulative Drive Power-on Time at the Fifth Fault (min.)	00~1439	00	○	○	○	○	○	○
	06-41	Accumulative Drive Power-on Time at the Fifth Fault (day)	00-65535	00	○	○	○	○	○	○
	06-42	Accumulative Drive Power-on Time at the Sixth Fault (min.)	00~1439	00	○	○	○	○	○	○
	06-43	Accumulative Drive Power-on Time at the Sixth Fault (day)	00-65535	00	○	○	○	○	○	○
↙	06-44	Operation Speed of (EPS) Emergency Power Mode	0.00~400.00Hz	Read Only	○	○	○	○	○	○
↙	06-45	Fault and Warning Handling Methods	Bit0 = 0: Display Lv fault and coast to stop Bit0 = 1: Display Lv warn and coast to stop Bit1 = 0: Fan lock, fault and coast to stop Bit1 = 1: Fan lock, warn and coast to stop Bit2 = 0: software GFF protection enabled Bit2 = 1: software GFF protection disabled	0002h	○	○	○	○	○	○
↙	06-46	Operation Direction for (EPS) Emergency Power ON	0: Run by following the current command 1: Run by following the direction of power generating mode. 2: After determining the direction of power generating, the host computer sends the operating direction command. (When at STOP mode determine the direction of power generating mode (MO =32) but do not retain the direction of the power generating.) 3. After determining the direction of power generating, the host computer send the operating direction command. (When at STOP mode, determine the direction of power generating mode (MO =32) and retain the direction of the power generating.)	0	○	○	○	○	○	○
↙	06-47	Power Generation Direction Searching Time	0.0 ~ 5.0 sec.	1.0	○	○	○	○	○	○
	06-48	Power Capacity of (EPS) Emergency Power	0.0 ~ 100.0 kVA	0.0	○	○	○	○	○	○
	06-49	STO Latch Selection	0: STO Latch 1: STO No Latch 2: STO Latch (Warn and record running commands when stop) 3: STO No Latch (Warn and record running commands when stop)	0	○	○	○	○	○	○
	06-50	Selection of MO's action when retrying after fault	0: Output 1: No output	0	○	○	○	○	○	○
	06-51	Number of times of retrying after fault	0~10	0	○	○	○	○	○	○

06-52	Time interval between retrying	0.5~600.0 sec.	10.0	<input type="checkbox"/>	<input type="checkbox"/>	<input type="checkbox"/>	<input type="checkbox"/>	<input type="checkbox"/>	<input type="checkbox"/>
06-53	Frequency command when the most recent fault has occurred	0.00~655.35Hz	0.00	<input type="checkbox"/>	<input type="checkbox"/>	<input type="checkbox"/>	<input type="checkbox"/>	<input type="checkbox"/>	<input type="checkbox"/>
06-54	Output frequency when the most recent fault has occurred	0.00~655.35Hz	0.00	<input type="checkbox"/>	<input type="checkbox"/>	<input type="checkbox"/>	<input type="checkbox"/>	<input type="checkbox"/>	<input type="checkbox"/>
06-55	Output current when the most recent fault has occurred	0.00~655.35Amps	0.00	<input type="checkbox"/>	<input type="checkbox"/>	<input type="checkbox"/>	<input type="checkbox"/>	<input type="checkbox"/>	<input type="checkbox"/>
06-56	Most recent fault on motor's frequency	0.00~655.35Hz	0.00	<input type="checkbox"/>	<input type="checkbox"/>	<input type="checkbox"/>	<input type="checkbox"/>	<input type="checkbox"/>	<input type="checkbox"/>
06-57	Output voltage when the most recent fault has occurred	0.00~6553.5V	0.0	<input type="checkbox"/>	<input type="checkbox"/>	<input type="checkbox"/>	<input type="checkbox"/>	<input type="checkbox"/>	<input type="checkbox"/>
06-58	DC bus voltage when the most recent fault has occurred	0.00~6553.5V	0.0	<input type="checkbox"/>	<input type="checkbox"/>	<input type="checkbox"/>	<input type="checkbox"/>	<input type="checkbox"/>	<input type="checkbox"/>
06-59	Output power when the most recent fault has occurred	0.00~6553.5KW	0.0	<input type="checkbox"/>	<input type="checkbox"/>	<input type="checkbox"/>	<input type="checkbox"/>	<input type="checkbox"/>	<input type="checkbox"/>
06-60	Output torque when the most recent fault has occurred	0.00~655.35%	0.00	<input type="checkbox"/>	<input type="checkbox"/>	<input type="checkbox"/>	<input type="checkbox"/>	<input type="checkbox"/>	<input type="checkbox"/>
06-61	IGBT's temperature when the most recent fault has occurred	-3276.8~3276.7°C	0.0	<input type="checkbox"/>	<input type="checkbox"/>	<input type="checkbox"/>	<input type="checkbox"/>	<input type="checkbox"/>	<input type="checkbox"/>
06-62	Multi-input terminals' status when the most recent fault has occurred	0000h~FFFFh	0000h	<input type="checkbox"/>	<input type="checkbox"/>	<input type="checkbox"/>	<input type="checkbox"/>	<input type="checkbox"/>	<input type="checkbox"/>
06-63	Multi-output terminals' status when the most recent fault has occurred	0000h~FFFFh	0000h	<input type="checkbox"/>	<input type="checkbox"/>	<input type="checkbox"/>	<input type="checkbox"/>	<input type="checkbox"/>	<input type="checkbox"/>
06-64	Motor drive's status when the most recent fault has occurred	0000h~FFFFh	0000h	<input type="checkbox"/>	<input type="checkbox"/>	<input type="checkbox"/>	<input type="checkbox"/>	<input type="checkbox"/>	<input type="checkbox"/>

07 Special Parameters

Pr.	Explanation	Setting Range	Factory Setting	VF	VFP	SVC	FOCPG	TQCPG	FOCPM
				<input type="checkbox"/>	<input type="checkbox"/>	<input type="checkbox"/>	<input type="checkbox"/>	<input type="checkbox"/>	<input type="checkbox"/>
✓ 07-00	Brake Chopper Level	230V series: 350.0~450.0Vdc 460V series: 700.0~900.0Vdc	380.0 760.0	<input type="checkbox"/>	<input type="checkbox"/>	<input type="checkbox"/>	<input type="checkbox"/>	<input type="checkbox"/>	<input type="checkbox"/>
07-01	Reserved								
✓ 07-02	DC Brake Current Level during start-up	0~100% (rated current of the motor drive)	0	<input type="checkbox"/>	<input type="checkbox"/>	<input type="checkbox"/>			
✓ 07-03	DC Brake Activation Time	0.0~60.0sec.	0.7	<input type="checkbox"/>	<input type="checkbox"/>	<input type="checkbox"/>	<input type="checkbox"/>		<input type="checkbox"/>
✓ 07-04	DC Brake Stopping Time	0.0~60.0sec.	0.7	<input type="checkbox"/>	<input type="checkbox"/>	<input type="checkbox"/>	<input type="checkbox"/>		<input type="checkbox"/>
✓ 07-05	Start Point for DC Brake	0.00~400.00Hz	0.00	<input type="checkbox"/>	<input type="checkbox"/>	<input type="checkbox"/>	<input type="checkbox"/>		
✓ 07-06	DC Brake Proportional Gain	1~500	50	<input type="checkbox"/>	<input type="checkbox"/>	<input type="checkbox"/>			
✓ 07-07	Dwell Time at Accel.	0.00~600.00sec.	0.00	<input type="checkbox"/>	<input type="checkbox"/>	<input type="checkbox"/>	<input type="checkbox"/>		<input type="checkbox"/>
✓ 07-08	Dwell Frequency at Accel.	0.00~400.00Hz	0.00	<input type="checkbox"/>	<input type="checkbox"/>	<input type="checkbox"/>	<input type="checkbox"/>		<input type="checkbox"/>
✓ 07-09	Dwell Time at Decel.	0.00~600.00sec.	0.00	<input type="checkbox"/>	<input type="checkbox"/>	<input type="checkbox"/>	<input type="checkbox"/>		<input type="checkbox"/>
✓ 07-10	Dwell Frequency at Decel.	0.00~400.00Hz	0.00	<input type="checkbox"/>	<input type="checkbox"/>	<input type="checkbox"/>	<input type="checkbox"/>		<input type="checkbox"/>
✓ 07-11	Cooling Fan Control	0: Cooling fan always ON 1: One minute after AC motor drive stops, cooling fan will be OFF 2: AC motor drive runs and cooling fan ON, AC motor drive stops and cooling fan OFF 3: Cooling fan ON to run when preliminary heat sink temperature attained 4: Cooling always OFF	2	<input type="checkbox"/>	<input type="checkbox"/>	<input type="checkbox"/>	<input type="checkbox"/>	<input type="checkbox"/>	<input type="checkbox"/>
✓ 07-12	Torque command	-150.0~150.0% (Pr07-14 setting =100%)	0.0					<input type="checkbox"/>	
✓ 07-13	Source of Torque Command	0: Digital keypad (KPC-CC01) 1: RS485 serial communication (RJ-11) 2: Analog signal (Pr.03-00)	2					<input type="checkbox"/>	
✓ 07-14	Maximum Torque Command	0~300% (rated torque of the motor drive)	100	<input type="checkbox"/>	<input type="checkbox"/>	<input type="checkbox"/>	<input type="checkbox"/>	<input type="checkbox"/>	<input type="checkbox"/>
✓ 07-15	Filter Time of Torque Command	0.000~1.000sec.	0.000					<input type="checkbox"/>	
07-16	Speed Limit Selection	0: By Pr.07-17 and Pr.07-18 1: Frequency command source (Pr.00-14)	0					<input type="checkbox"/>	
✓ 07-17	Torque Mode +Speed Limit	0~120%	10					<input type="checkbox"/>	
✓ 07-18	Torque Mode-Speed Limit	0~120%	10					<input type="checkbox"/>	
✓ 07-19	Source of Torque Offset	0: Disable 1: Analog input (Pr.03-00) 2: Torque offset setting (Pr.07-20) 3: Control by external terminal (by Pr.07-21 to Pr.07-23)	0			<input type="checkbox"/>	<input type="checkbox"/>	<input type="checkbox"/>	<input type="checkbox"/>
✓ 07-20	Torque Offset Setting	0.0~100.0% (rated torque of the motor drive)	0.0			<input type="checkbox"/>	<input type="checkbox"/>	<input type="checkbox"/>	<input type="checkbox"/>

↘	07-21	High Torque Offset	0.0~100.0% (rated torque of the motor drive)	30.0			<input type="radio"/>	<input type="radio"/>	<input type="radio"/>	<input type="radio"/>
↘	07-22	Middle Torque Offset	0.0~100.0% (rated torque of the motor drive)	20.0			<input type="radio"/>	<input type="radio"/>	<input type="radio"/>	<input type="radio"/>
↘	07-23	Low Torque Offset	0.0~100.0% (rated torque of the motor drive)	10.0			<input type="radio"/>	<input type="radio"/>	<input type="radio"/>	<input type="radio"/>
↘	07-24	Forward Motor Torque Limit	0~300% (rated torque of the motor drive)	200			<input type="radio"/>	<input type="radio"/>	<input type="radio"/>	
↘	07-25	Forward Regenerative Torque Limit	0~300% (rated torque of the motor drive)	200			<input type="radio"/>	<input type="radio"/>	<input type="radio"/>	
↘	07-26	Reverse Motor Torque Limit	0~300% (rated torque of the motor drive)	200			<input type="radio"/>	<input type="radio"/>	<input type="radio"/>	
↘	07-27	Reverse Regenerative Torque Limit	0~300% (rated torque of the motor drive)	200			<input type="radio"/>	<input type="radio"/>	<input type="radio"/>	
↘	07-28	Emergency Stop (EF) & Forced Stop Selection	0: Coast to stop 1: By deceleration Time 1 2: By deceleration Time 2 3: By deceleration Time 3 4: By deceleration Time 4 5: By Pr.01-31	0	<input type="radio"/>	<input type="radio"/>	<input type="radio"/>	<input type="radio"/>	<input type="radio"/>	<input type="radio"/>
↘	07-29	Time for Decreasing Torque at Stop	0.000~1.000sec.	0.000			<input type="radio"/>	<input type="radio"/>	<input type="radio"/>	
↘	07-30	DC Brake Current Level Stop	0~100% (rated current of the motor drive)	0	<input type="radio"/>	<input type="radio"/>	<input type="radio"/>			

08 PM Parameters

Pr.	Explanation	Setting Range	Factory Setting	VF	VFP	SVC	FOCPG	TQCPG	FOCPM
08-00	Motor Auto Tuning	0: No function 1: Only for the unloaded motor, auto measure the angle between magnetic pole and PG origin (08-09) 2: For PM parameters 3: Auto measure the angle between magnetic pole and PG origin (08-09)	0						<input type="radio"/>
08-01	Full-load Current of Motor	(40~120%) *00-01 Amps	###						<input type="radio"/>
08-02	Rated power of Motor	0.00~655.35kW	###						<input type="radio"/>
08-03	Rated speed of Motor (rpm)	0~65535	1710						<input type="radio"/>
08-04	Number of Motor Poles	2~96	4						<input type="radio"/>
08-05	Rs of Motor	0.000~65.535Ω	0.000						<input type="radio"/>
08-06	Ld of Motor	0.0~6553.5mH	0.0						<input type="radio"/>
08-07	Lq of Motor	0.0~6553.5mH	0.0						<input type="radio"/>
08-08	Back Electromotive Force	0.0~6553.5Vrms	0.0						<input type="radio"/>
08-09	Angle between Magnetic Pole and PG Origin	0.0~360.0°	360.0						<input type="radio"/>
08-10	Magnetic Pole Re-orientation	0: Disable 1: Enable	0						<input type="radio"/>

09 Communication Parameters

Pr.	Explanation	Setting Range	Factory Setting	VF	VFPG	SVC	FOCPG	TQCPG	FOCPM
✓ 09-00	Communication Address	1~254	1						
✓ 09-01	Transmission Speed	4.8~115.2Kbps	19.2	○	○	○	○	○	○
✓ 09-02	Transmission Fault Treatment	0: Warn and keep operation 1: Warn and ramp to stop 2: Reserved 3: No action and no display	3	○	○	○	○	○	○
✓ 09-03	Time-out Detection	0.0~100.0sec.	0.0	○	○	○	○	○	○
✓ 09-04	Communication Protocol	0: 7N1 (ASCII) 1: 7N2 (ASCII) 2: 7E1 (ASCII) 3: 7O1 (ASCII) 4: 7E2 (ASCII) 5: 7O2 (ASCII) 6: 8N1 (ASCII) 7: 8N2 (ASCII) 8: 8E1 (ASCII) 9: 8O1 (ASCII) 10: 8E2 (ASCII) 11: 8O2 (ASCII) 12: 8N1 (RTU) 13: 8N2 (RTU) 14: 8E1 (RTU) 15: 8O1 (RTU) 16: 8E2 (RTU) 17: 8O2 (RTU)	13	○	○	○	○	○	○
✓ 09-05	Response Delay Time	0.0~200.0ms	2.0	○	○	○	○	○	○
09-06 ~09-13	Direct docking mode only ◆								

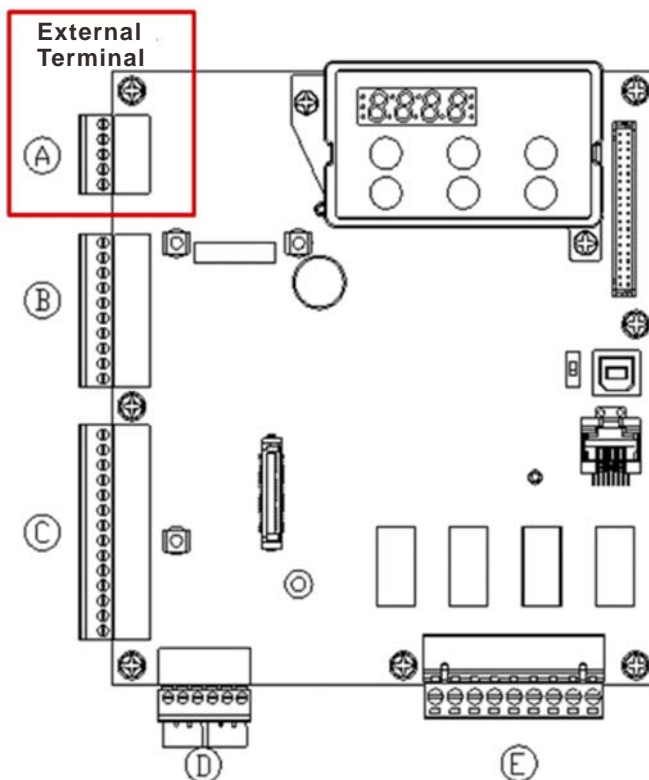

10 Speed Feedback Control Parameters

Pr.	Explanation	Setting Range	Factory Setting	VF	VFPF	SVC	FOCPG	TQCPG	FOCPM
10-00	Selection of Encoder	0: Disable 1: ABZ 2: ABZ+Hall 3: SIN/COS + Sinusoidal 4: SIN/COS + Endat 5: SIN/COS 6: SIN/COS + Hiperface	0		<input type="radio"/>		<input type="radio"/>	<input type="radio"/>	<input type="radio"/>
10-01	Encoder Pulse	1~25000	2048		<input type="radio"/>		<input type="radio"/>	<input type="radio"/>	<input type="radio"/>
10-02	Encoder Input Type Setting	0: Disable 1: Phase A leads in a forward run command and phase B leads in a reverse run command 2: Phase B leads in a forward run command and phase A leads in a reverse run command 3: Phase A is a pulse input and phase B is a direction input. (low input=reverse direction, high input=forward direction) 4: Phase A is a pulse input and phase B is a direction input. (low input=forward direction, high input=reverse direction) 5: Single-phase input	0		<input type="radio"/>		<input type="radio"/>	<input type="radio"/>	<input type="radio"/>
✓ 10-03	Encoder Feedback Fault Treatment (PGF1, PGF2)	0: Warn and keep operation 1: Fault and ramp to stop 2: Fault and stop operation	2		<input type="radio"/>		<input type="radio"/>	<input type="radio"/>	<input type="radio"/>
✓ 10-04	Detection Time for Encoder Feedback Fault	0.0~10.0sec.	1.0		<input type="radio"/>		<input type="radio"/>	<input type="radio"/>	<input type="radio"/>
✓ 10-05	Encoder Stall Level (PGF3)	0~120% (0: Disable)	115		<input type="radio"/>	<input type="radio"/>	<input type="radio"/>		<input type="radio"/>
✓ 10-06	Encoder Stall Detection Time	0.0~2.0sec.	0.1		<input type="radio"/>	<input type="radio"/>	<input type="radio"/>		<input type="radio"/>
✓ 10-07	Encoder Slip Range (PGF4)	0~50% (0: Disable)	50		<input type="radio"/>	<input type="radio"/>	<input type="radio"/>		<input type="radio"/>
✓ 10-08	Encoder Slip Detection Time	0.0~10.0sec.	0.5		<input type="radio"/>	<input type="radio"/>	<input type="radio"/>		<input type="radio"/>
✓ 10-09	Encoder Stall and Slip Error Treatment	0: Warn and keep operation 1: Fault and ramp to stop 2: Fault and coast to stop	2		<input type="radio"/>	<input type="radio"/>	<input type="radio"/>		<input type="radio"/>
10-10	Mode Selection for UVW Input	0: Z signal is at the falling edge of U-phase 1: Z signal is at the rising edge of U-phase	0		<input type="radio"/>		<input type="radio"/>	<input type="radio"/>	<input type="radio"/>
✓ 10-11	ASR (Auto Speed Regulation) Control (P) of Zero Speed	0.0~1000.0%	100.0	<input type="radio"/>	<input type="radio"/>	<input type="radio"/>	<input type="radio"/>		<input type="radio"/>
✓ 10-12	ASR (Auto Speed Regulation) Control (I) of Zero Speed	0.000~10.000sec.	0.100	<input type="radio"/>	<input type="radio"/>	<input type="radio"/>	<input type="radio"/>		<input type="radio"/>
✓ 10-13	ASR (Auto Speed Regulation) Control (P) 1	0.0~1000.0%	100.0	<input type="radio"/>	<input type="radio"/>	<input type="radio"/>	<input type="radio"/>		<input type="radio"/>
✓ 10-14	ASR (Auto Speed Regulation) Control (I) 1	0.000~10.000sec.	0.100	<input type="radio"/>	<input type="radio"/>	<input type="radio"/>	<input type="radio"/>		<input type="radio"/>
✓ 10-15	ASR (Auto Speed Regulation) Control (P) 2	0.0~1000.0%	100.0	<input type="radio"/>	<input type="radio"/>	<input type="radio"/>	<input type="radio"/>		<input type="radio"/>

✓	10-16	ASR (Auto Speed Regulation) Control (I) 2	0.000~10.000sec.	0.100	<input type="radio"/>	<input type="radio"/>	<input type="radio"/>	<input type="radio"/>	<input type="radio"/>	<input type="radio"/>
✓	10-17	ASR 1/ ASR2 Switch Frequency	0.00~400.00Hz (0: Disable)	7.00	<input type="radio"/>	<input type="radio"/>	<input type="radio"/>	<input type="radio"/>	<input type="radio"/>	<input type="radio"/>
✓	10-18	ASR Primary Low Pass Filter Gain	0.000~0.350sec.	0.008	<input type="radio"/>	<input type="radio"/>	<input type="radio"/>	<input type="radio"/>	<input type="radio"/>	<input type="radio"/>
✓	10-19	Zero Speed Gain (P)	0~655.00%	80.00						<input type="radio"/>
✓	10-20	Zero Speed/ ASR1 Width Adjustment	0.00~400.00Hz	5.00		<input type="radio"/>		<input type="radio"/>		<input type="radio"/>
✓	10-21	ASR1/ASR2 Width Adjustment	0.00~400.00Hz	5.00		<input type="radio"/>		<input type="radio"/>		<input type="radio"/>
✓	10-22	Zero speed Position Holding Time	0.000~65.535s	0.250						<input type="radio"/>
✓	10-23	Filter Time at Zero Speed	0.000~65.535s	0.004						<input type="radio"/>
✓	10-24	Time for Executing Zero Speed	0: after the brake release set in Pr.02-29 1: after the brake signal input (Pr.02-01~02-08 is set to 42)	0						<input type="radio"/>
✓	10-25	Elevator Leveling (Zero Speed Gain P)	0.0~1000.0%	100.0	<input type="radio"/>	<input type="radio"/>	<input type="radio"/>	<input type="radio"/>	<input type="radio"/>	<input type="radio"/>
✓	10-26	Elevator Leveling (Zero Speed Integral I)	0.000~10.000sec.	0.100	<input type="radio"/>	<input type="radio"/>	<input type="radio"/>	<input type="radio"/>	<input type="radio"/>	<input type="radio"/>
✓	10-27	Elevator Starts (Zero Speed Gain P)	0.0~1000.0%	100.0	<input type="radio"/>	<input type="radio"/>	<input type="radio"/>	<input type="radio"/>	<input type="radio"/>	<input type="radio"/>
✓	10-28	Elevator Starts (Zero Speed Integral I)	0.000~10.000sec.	0.100	<input type="radio"/>	<input type="radio"/>	<input type="radio"/>	<input type="radio"/>	<input type="radio"/>	<input type="radio"/>
✓	10-29	Setting of PG card frequency division output	0~31	0		<input type="radio"/>		<input type="radio"/>	<input type="radio"/>	<input type="radio"/>
✓	10-30	Type of PG card frequency division output	0000h~0008h	0000h		<input type="radio"/>		<input type="radio"/>	<input type="radio"/>	<input type="radio"/>
	10-31	PG card C+/C- Selection	0000h~0001h	0000h						

11 Advanced Parameters

Pr.	Explanation	Setting Range	Factory Setting	VF	VFG	SVC	FOCPG	TQCPG	FOCPM
11-00	System Control	Bit 0=0: no function Bit 0=1: ASR Auto tuning, PDFF enable Bit 7=0: no function Bit 7=1: When position control is enabled, it doesn't need to set Pr.07-02 (DC Brake Current Level) Bit 9=0: Rolling PG Origin auto-tuning with load (support by PGHSD-1) Bit 9=1: Static PG Origin auto-tuning with load by enabling PGHSD-1 Bit 15=0: when power is applied, it will detect the position of magnetic pole again Bit 15=1: when power is applied, it will start from the magnetic pole position of previous power failure	0000h				<input type="radio"/>		<input type="radio"/>
✓	11-01	Elevator Speed	0.10~4.00 m/s	1.00			<input type="radio"/>		<input type="radio"/>
✓	11-02	Sheave Diameter	100~2000mm	400			<input type="radio"/>		<input type="radio"/>
✓	11-03	Mechanical Gear Ratio	1~100	1			<input type="radio"/>		<input type="radio"/>
✓	11-04	Suspension Ratio	0= 1:1 1= 2:1	1			<input type="radio"/>		<input type="radio"/>
✓	11-05	Inertial Ratio	1~300%	40			<input type="radio"/>		<input type="radio"/>
✓	11-06	Zero-speed Bandwidth	1~40Hz	10			<input type="radio"/>		<input type="radio"/>
✓	11-07	Low-speed Bandwidth	1~40Hz	10			<input type="radio"/>		<input type="radio"/>
✓	11-08	High-speed Bandwidth	1~40Hz	10			<input type="radio"/>		<input type="radio"/>
✓	11-09	PDFF Gain Value	0~200%	30			<input type="radio"/>		<input type="radio"/>
✓	11-10	Gain for Speed Feed Forward	0~500	0			<input type="radio"/>		<input type="radio"/>
✓	11-11	Notch Filter Depth	0~20db	0			<input type="radio"/>		<input type="radio"/>
✓	11-12	Notch Filter Frequency	0.00~200.00Hz	0.00			<input type="radio"/>		<input type="radio"/>
✓	11-13	Low-pass Filter Time of Keypad Display	0.001~65.535s	0.500	<input type="radio"/>	<input type="radio"/>	<input type="radio"/>	<input type="radio"/>	<input type="radio"/>
✓	11-14	Motor Current at Accel.	50~200%	150					<input type="radio"/>
✓	11-15	Elevator Acceleration	0.20~2.00m/s ²	0.75					<input type="radio"/>
	11-16	Reserved	0000h~FFFFh	0	<input type="radio"/>	<input type="radio"/>	<input type="radio"/>	<input type="radio"/>	<input type="radio"/>
	11-17	Reserved	Read Only	###	<input type="radio"/>	<input type="radio"/>	<input type="radio"/>	<input type="radio"/>	<input type="radio"/>
	11-18	Reserved	0000h~FFFFh	###	<input type="radio"/>	<input type="radio"/>	<input type="radio"/>	<input type="radio"/>	<input type="radio"/>
✓	11-19	Zero-speed Holding Speed	1~40Hz	10			<input type="radio"/>		<input type="radio"/>

12 User Defined Parameters

User-defined Parameters with range from Group 00 to Group 11

Pr.	Explanation (Default Function)	Address	Factory setting	VF	VFP	SVC	FOCPG	TQCPG	FOCPM
✓ 12-00	Present Fault Record	0616	Read Only	<input type="radio"/>	<input type="radio"/>	<input type="radio"/>	<input type="radio"/>	<input type="radio"/>	<input type="radio"/>
✓ 12-01	Present Fault Time of Motor Operation (min.)	0632	Read Only	<input type="radio"/>	<input type="radio"/>	<input type="radio"/>	<input type="radio"/>	<input type="radio"/>	<input type="radio"/>
✓ 12-02	Present Fault Time of Motor Operation (day)	0633	Read Only	<input type="radio"/>	<input type="radio"/>	<input type="radio"/>	<input type="radio"/>	<input type="radio"/>	<input type="radio"/>
✓ 12-03	Frequency Command at Present Fault	0653	Read Only	<input type="radio"/>	<input type="radio"/>	<input type="radio"/>	<input type="radio"/>	<input type="radio"/>	<input type="radio"/>
✓ 12-04	Output Frequency at Preset Fault	0654	Read Only	<input type="radio"/>	<input type="radio"/>	<input type="radio"/>	<input type="radio"/>	<input type="radio"/>	<input type="radio"/>
✓ 12-05	Output Current at Present Fault	0655	Read Only	<input type="radio"/>	<input type="radio"/>	<input type="radio"/>	<input type="radio"/>	<input type="radio"/>	<input type="radio"/>
✓ 12-06	Motor Frequency at Present Fault	0656	Read Only	<input type="radio"/>	<input type="radio"/>	<input type="radio"/>	<input type="radio"/>	<input type="radio"/>	<input type="radio"/>
✓ 12-07	Output Voltage at Present Fault	0657	Read Only	<input type="radio"/>	<input type="radio"/>	<input type="radio"/>	<input type="radio"/>	<input type="radio"/>	<input type="radio"/>
✓ 12-08	DC-Bus Voltage at Present Fault	0658	Read Only	<input type="radio"/>	<input type="radio"/>	<input type="radio"/>	<input type="radio"/>	<input type="radio"/>	<input type="radio"/>
✓ 12-09	Output Power at Present Fault	0659	Read Only	<input type="radio"/>	<input type="radio"/>	<input type="radio"/>	<input type="radio"/>	<input type="radio"/>	<input type="radio"/>
✓ 12-10	Output Torque at Present Fault	0660	Read Only	<input type="radio"/>	<input type="radio"/>	<input type="radio"/>	<input type="radio"/>	<input type="radio"/>	<input type="radio"/>
✓ 12-11	IGBT Temperature of Power Module at Present Fault	0661	Read Only	<input type="radio"/>	<input type="radio"/>	<input type="radio"/>	<input type="radio"/>	<input type="radio"/>	<input type="radio"/>
✓ 12-12	Multi-function Terminal Input Status at Present Fault	0662	Read Only	<input type="radio"/>	<input type="radio"/>	<input type="radio"/>	<input type="radio"/>	<input type="radio"/>	<input type="radio"/>
✓ 12-13	Multi-function Terminal Output Status at Present Fault	0663	Read Only	<input type="radio"/>	<input type="radio"/>	<input type="radio"/>	<input type="radio"/>	<input type="radio"/>	<input type="radio"/>
✓ 12-14	Drive Status at Present Fault	0664	Read Only	<input type="radio"/>	<input type="radio"/>	<input type="radio"/>	<input type="radio"/>	<input type="radio"/>	<input type="radio"/>
✓ 12-15	Second Most Recent Fault Record	0617	Read Only	<input type="radio"/>	<input type="radio"/>	<input type="radio"/>	<input type="radio"/>	<input type="radio"/>	<input type="radio"/>
✓ 12-16	Second Most Recent Fault Time of Motor Operation (min.)	0634	Read Only	<input type="radio"/>	<input type="radio"/>	<input type="radio"/>	<input type="radio"/>	<input type="radio"/>	<input type="radio"/>
✓ 12-17	Second Most Recent Fault Time of Motor Operation (day)	0635	Read Only	<input type="radio"/>	<input type="radio"/>	<input type="radio"/>	<input type="radio"/>	<input type="radio"/>	<input type="radio"/>
✓ 12-18	Third Most Recent Fault Record	0618	Read Only	<input type="radio"/>	<input type="radio"/>	<input type="radio"/>	<input type="radio"/>	<input type="radio"/>	<input type="radio"/>
✓ 12-19	Third Most Recent Fault Time of Motor Operation (min.)	0636	Read Only	<input type="radio"/>	<input type="radio"/>	<input type="radio"/>	<input type="radio"/>	<input type="radio"/>	<input type="radio"/>
✓ 12-20	Third Most Recent Fault Time of Motor Operation (day)	0637	Read Only	<input type="radio"/>	<input type="radio"/>	<input type="radio"/>	<input type="radio"/>	<input type="radio"/>	<input type="radio"/>
✓ 12-21	Fourth Most Recent Fault Record	0619	Read Only	<input type="radio"/>	<input type="radio"/>	<input type="radio"/>	<input type="radio"/>	<input type="radio"/>	<input type="radio"/>
✓ 12-22	Fourth Most Recent Fault Time of Motor Operation (min.)	0638	Read Only	<input type="radio"/>	<input type="radio"/>	<input type="radio"/>	<input type="radio"/>	<input type="radio"/>	<input type="radio"/>
✓ 12-23	Fourth Most Recent Fault Time of Motor Operation (day)	0639	Read Only	<input type="radio"/>	<input type="radio"/>	<input type="radio"/>	<input type="radio"/>	<input type="radio"/>	<input type="radio"/>
✓ 12-24	Fifth Most Recent Fault Record	0620	Read Only	<input type="radio"/>	<input type="radio"/>	<input type="radio"/>	<input type="radio"/>	<input type="radio"/>	<input type="radio"/>
✓ 12-25	Fifth Most Recent Fault Time of Motor Operation (min.)	0640	Read Only	<input type="radio"/>	<input type="radio"/>	<input type="radio"/>	<input type="radio"/>	<input type="radio"/>	<input type="radio"/>
✓ 12-26	Fifth Most Recent Fault Time of Motor Operation (day)	0641	Read Only	<input type="radio"/>	<input type="radio"/>	<input type="radio"/>	<input type="radio"/>	<input type="radio"/>	<input type="radio"/>
✓ 12-27	Sixth Most Recent Fault Record	0621	Read Only	<input type="radio"/>	<input type="radio"/>	<input type="radio"/>	<input type="radio"/>	<input type="radio"/>	<input type="radio"/>
✓ 12-28	Sixth Most Recent Fault Time of Motor Operation (min.)	0642	Read Only	<input type="radio"/>	<input type="radio"/>	<input type="radio"/>	<input type="radio"/>	<input type="radio"/>	<input type="radio"/>
✓ 12-29	Sixth Most Recent Fault Time of Motor Operation (day)	0643	Read Only	<input type="radio"/>	<input type="radio"/>	<input type="radio"/>	<input type="radio"/>	<input type="radio"/>	<input type="radio"/>
✓ 12-30	No factory setting								
✓ 12-31	No factory setting								

13 View User Defined Parameters

Pr.	Explanation	Setting Range	Factory Setting	VF	VFPG	SVC	FOCPG	TQCPG	FOCPM
13-00 ~ 13-31	View User Defined Parameters	Pr00-00~ Pr11-19	-	○	○	○	○	○	○

12 Descriptions of Parameter Settings



↗: The parameter can be set during operation

00 Drive Parameters

00-00 Identity Code of the AC Motor Drive

Control Mode **VF VFPG SVC FOC PG TQCPG FOC PM** Factory setting: ##
Settings Read Only

00-01 Rated Current Display of the AC Motor Drive

Control Mode **VF VFPG SVC FOC PG TQCPG FOC PM** Factory setting: ##
Settings Read Only

Pr. 00-00 displays the identity code of the AC motor drive. The capacity, rated current, rated voltage and the max. carrier frequency relate to the identity code. Users can use the following table to check how the rated current, rated voltage and max. carrier frequency of the AC motor drive corresponds to the identity code.

Pr.00-01 displays the rated current of the AC motor drive. By reading this parameter the user can check if the AC motor drive is correct.

230V series											
Power (KW)	2.2*	3.7*	4.0	5.5	7.5	11	15	18.5	22	30	37
Horsepower (HP)	3	5	5	7.5	10	15	20	25	30	40	50
ID Code of the Motor Drive (Pr00-00)	108	110	10	12	14	16	18	20	22	24	26
Rated Output Current for General Purposes (A)	12.0	17.0	20	24	30	45	58	77	87	132	161
Range of the Carrier Frequency	2~15kHz								2~9kHz		
Rated Max. Output Carrier Frequency	8kHz			10kHz			8kHz		6kHz		

*VFD022ED21S and VFD037ED21S are single phase models.

460V series												
Power (KW)	4.0	5.5	7.5	11	15	18.5	22	30	37	45	55	75
Horsepower (HP)	5	7.5	10	15	20	25	30	40	50	60	75	100
ID Code of the Motor Drive (Pr00-00)	11	13	15	17	19	21	23	25	27	29	31	33
Rated Output Current for General Purposes (A)	11.5	13	17	23	30	38	45	58	80	100	128	165
Range of the Carrier Frequency	2~ 15kHz						2~ 9kHz			2~ 6kHz		
Rated Max. Output Carrier Frequency	8kHz	10kHz			8kHz			6kHz				

00-02 Parameter Reset

Control Mode **VF** **VFP** **SVC** **FOCPG** **TQCPG** **FOCPM** Factory Setting : 0

- Settings
- 0: No Function
 - 1: Read Only
 - 5: Direct docking mode only, contact Delta for more information. ◆
 - 8: Keypad Lock
 - 9: All parameters are reset to factory settings (50Hz)
 - 10: All parameters are reset to factory settings (60Hz)

- 📖 When it is set to 1, all parameters are read only except Pr00-00~Pr00-07 and it can be used with password setting for password protection.
- 📖 To go back to the factory setting, set Pr00-02 = 9 or 10. If it is locked by a password, enter the password to go back to the factory setting. The password will also be erased.
- 📖 When Pr.00-02=08, the keypad is locked and only Pr.00-02 and Pr00-07 can be set. To unlock the keypad, set Pr.00-02=00.

00-03 Start-up Display Selection

Control Mode **VF** **VFP** **SVC** **FOCPG** **TQCPG** **FOCPM** Factory Setting: 0

- Settings
- 0: Display the frequency command value. (LED F)
 - 1: Display the actual output frequency (LED H)
 - 2: DC BUS voltage (V)
 - 3: Display the output current (A)
 - 4: Output voltage (E)
 - 5: User defined (see Pr.00-04)

- 📖 This parameter determines the start-up display page after power is applied to the drive.

00-04 Content of Multi-Function Display

Control Mode **VF** **VFP** **SVC** **FOCPG** **TQCPG** **FOCPM** Factory Setting: 0

- Settings
- 0: Display the output current in A supplied to the motor
 - 1: Reserved
 - 2: Display actual output frequency (H)
 - 3: Display the actual DC BUS voltage in VDC of the AC motor drive
 - 4: Display the output voltage in VAC of terminals U, V, and W to the motor.
 - 5: Display the power factor angle in ° of terminals U, V, W to the motor.
 - 6: Display the output power in kW of terminals U, V and W to the motor.
 - 7: Display the actual motor speed in rpm (enabled when using with PG card).
 - 8: Display the estimated value of torque in % as it relates to current.
 - 9 : Display PG position
 - 10: Display the electrical angle of drive output

- 11: Display the signal of AUI1 analog input terminal in %.
Range -10V~10V corresponds to 0~100%. (1.)
- 12: Reserved
- 13: Display the signal of AUI2 analog input terminal in %.
Range -10V~10V corresponds to 0~100%. (3.)
- 14: Display the temperature of heat sink (°C)
- 15P: Display the temperature of IGBT in °C.
- 16: Display digital input status ON/OFF (i)
- 17: Display digital output status ON/OFF (o)
- 18: Display multi-step speed
- 19: The corresponding CPU pin status of digital input (i.)
- 20: The corresponding CPU pin status of digital output (o.)
- 21~23: Reserved
- 24: Output AC voltage when malfunction (8)
- 25: Output DC voltage when malfunction (8.)
- 26: Motor frequency when malfunction (h)
- 27: Output current when malfunction (4)
- 28: Output frequency when malfunction (h.)
- 29: Frequency command when malfunction
- 30: Output power when malfunction
- 31: Output torque when malfunction
- 32: Input terminal status when malfunction
- 33: Output terminal status when malfunction
- 34: Drive status when malfunction

 This parameter is to display the content on the page U of digital keypad KPC-CC01. It is helpful for getting the AC motor drive's status by this parameter.

Example 01:

Terminal	MI8	MI7	MI6	MI5	MI4	MI3	MI2	MI1	REV	FWD
Status	0	0	1	0	0	0	0	1	1	0

0: OFF, 1: ON

MI1: Pr.02-01 is set to 1 (multi-step speed command 1)

MI8: Pr.02-08 is set to 8 (the 1st, 2nd acceleration/deceleration time selection)

If REV, MI1 and MI8 are ON, the value is 0000 0000 1000 01102 in binary and 0086H in HEX. Meanwhile, if Pr.00-04 is set to "16" or "19", it will display "0086" with LED U is ON on the keypad KPC-CC01. The setting 16 is the status of digital input and the setting 19 is the corresponding CPU pin status of digital input. User can set to 16 to monitor digital input status and then set to 19 to check if the wire is normal.

Example 02:

Terminal	MO8	MO7	MO6	MO5	MO4	MO3	MO2	MO1	R2A	R1A	MRA	RA
Status	0	0	0	0	1	0	0	0	0	1	1	0

RA: Pr.02-11 is set to 9 (Drive ready).

After applying the power to the AC motor drive, if there is no other abnormal status, the contact will be ON. At the meanwhile, if Pr.00-04 is set to 17 or 20, it will display 0001 with LED U is ON on the keypad. The setting 17 is the status of digital output and the setting 20 is the corresponding CPU pin status of digital output. User can set 17 to monitor the digital output status and then set to 20 to check if the wire if normal.

⚡ **00-05** User Defined Coefficient K

Control Mode	VF	VFPG	SVC	FOCPG	TQCPG	FOCPM	Factory Setting: 0
Settings	Digit 4: decimal point number (0 to 3)						
	Digit 0-3: 40 to 9999						

- 📖 It is used digital setting method
- 📖 Digital 4: decimal point number (0: no decimal point, 1: 1 decimal point and so on.)
- 📖 Digit 0-3: 40 to 9999 (the corresponding value for the max. frequency).

Meaning of numerical order

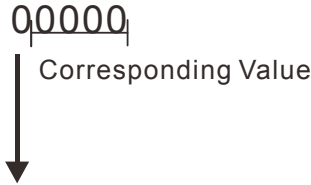

Decimal Point Number

- 📖 For example, if use uses rpm to display the motor speed and the corresponding value to the 4-pole motor 60Hz is 1800. This parameter can be set to 01800 to indicate that the corresponding value for 60Hz is 1800rpm. If the unit is rps, it can be set 10300 to indicate the corresponding value for 60Hz is 30.0 (a decimal point).
- 📖 Only frequency setting can be displayed by the corresponding value.
- 📖 After setting Pr.00-05, it won't display the unit of frequency "Hz" after returning to the main menu.

⚡ **00-06** Software Version

Control Mode	VF	VFPG	SVC	FOCPG	TQCPG	FOCPM	Factory Setting: #.##
Settings	Read Only						

⚡ **00-07** Password Input

Control Mode	VF	VFPG	SVC	FOCPG	TQCPG	FOCPM	Factory Setting: 0
Settings	1~9998 · 10000~65535						
Display	0~2 (times of wrong password)						

- 📖 The function of this parameter is to input the password that is set in Pr.00-08. Input the correct password here to enable changing parameters. You are limited to a maximum of 3 attempts. After 3 consecutive failed attempts, a fault code "Password Error" will show up to force the user to restart the AC motor drive in order to try again to input the correct password.
- 📖 When forgetting password, you can decode by setting 9999 and press button twice. Note that all the settings will be set to factory setting.

⚡ **00-08** Password Set

Control Mode	VF	VFPG	SVC	FOCPG	TQCPG	FOCPM	Factory Setting: 0
Settings	1~9998 · 10000~65535						
Display	0: No password set or successful input in Pr. 00-07						
	1: Password has been set						

- 📖 To set a password to protect your parameter settings.
If the display shows 0, no password is set or password has been correctly entered in Pr.00-07. All parameters can then be changed, including Pr.00-08.
The first time you can set a password directly. After successful setting of password the display will show 1.

Be sure to record the password for later use.

To cancel the parameter lock, set the parameter to 0 after inputting correct password into Pr. 00-07.

The password consists of min. 2 digits and max. 5 digits.

How to make the password valid again after decoding by Pr.00-07:

Method 1: Re-input original password into Pr.00-08 (Or you can enter a new password if you want to use a changed or new one).

Method 2: After rebooting, password function will be recovered.

Password Decode Flow Chart

Password Setting

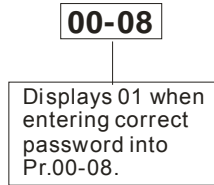

Decoding Flow Chart

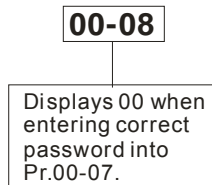

Forgetting Password

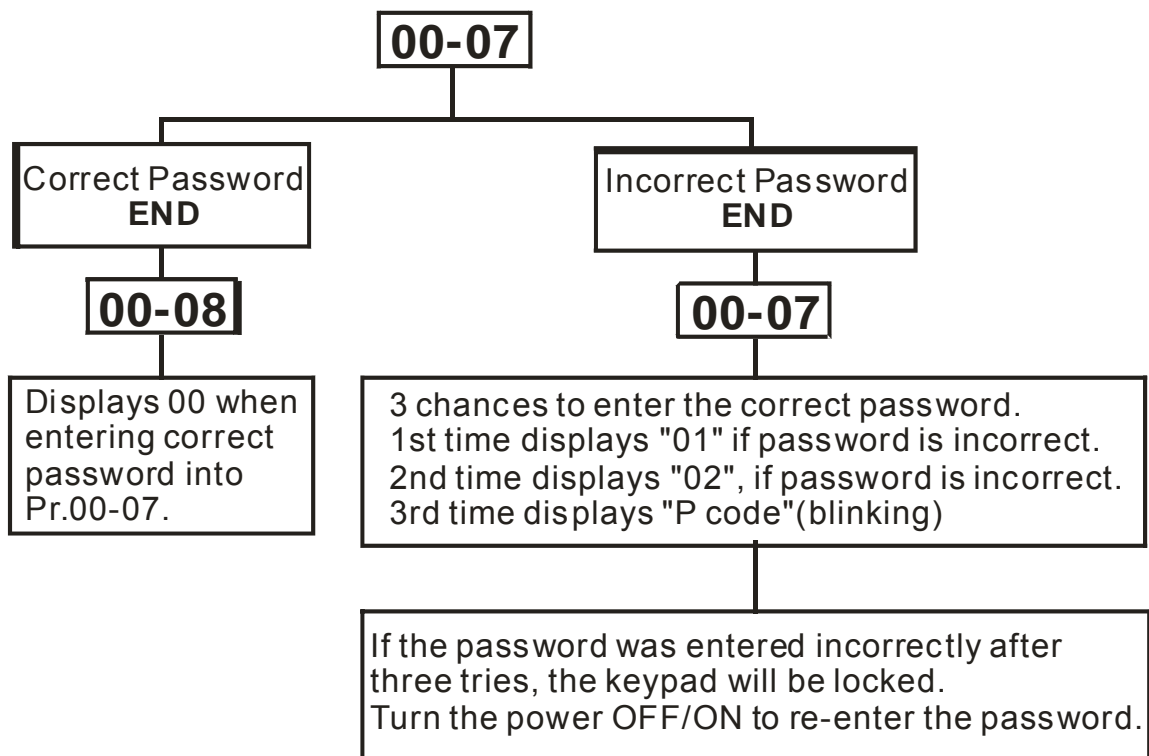
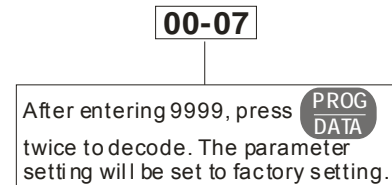

00-09 Control Mode

Control Mode **VF VFBG SVC FOC PG TQCPG FOC PM** Factory Setting: 0

- Settings
- 0: V/F control
 - 1: V/F control + Encoder (VFBG)
 - 2: Sensorless Vector Control (SVC)
 - 3 : FOC vector control + Encoder (FOCPG)
 - 4: Torque control + Encoder (TQCPG)
 - 8: FOC Permanent Motor Control+ Encoder (FOCPM)

This parameter determines the control method of the AC motor drive:

Setting 0: user can design V/f ratio by requirement and control multiple motors simultaneously.

Setting 1: User can use PG card with Encoder to do close-loop speed control.

Setting 2: To have optimal control characteristic by auto-tuning.

Setting 3: To increase torque and control speed precisely. (1:1000)

Setting 4: To increase accuracy for torque control.

Setting 8: To increase torque and control speed precisely. (1:1000). This setting is only for using with permanent magnet motor and others are for induction motor.

⚡ **00-10** Speed Unit

Control Mode **VF** **VFP** **SVC** **FOCP** **TQCP** **FOCP** Factory Setting: 0

Settings 0:Hz

1:m/s

2:ft/s

3:: Direct docking mode only, contact Delta for more information. ◆

⚡ **00-11** Output Direction Selection

Control Mode **VF** **VFP** **SVC** **FOCP** **TQCP** **FOCP** Factory Setting: 0

Settings 0: FWD: counterclockwise, REV: clockwise

1: FWD: clockwise, REV: counterclockwise

⚡ **00-12** Carrier Frequency

Control Mode **VF** **VFP** **SVC** **FOCP** **TQCP** **FOCP** Factory Setting:12

Settings 2~15kHz

📖 This parameter determinates the PWM carrier frequency of the AC motor drive.

Models	3~ 5HP	7.5-15HP	20-30HP	40-60HP	75-100HP
Settings	2~ 15kHz	2~ 15kHz	2~15kHz	2~ 9kHz	2~ 6kHz
Factory Setting	8 kHz	10kHz	8kHz	6kHz	6kHz

Carrier Frequency	Acoustic Noise	Electromagnetic Noise or Leakage Current	Heat Dissipation	Current Wave
2kHz	Significant ↑ ↓ Minimal	Minimal	Minimal	
8kHz		↑ ↓ Significant	↑ ↓ Significant	
15kHz				

📖 From the table, we see that the PWM carrier frequency has a significant influence on the electromagnetic noise, AC motor drive heat dissipation, and motor acoustic noise.

📖 If the carrier frequency is set to be higher than the factory settings in the table above, the motor drive will derate its capacity. See Derating Capacity of Carrier Frequency (Fc) in CH02.

⚡ **00-13** Auto Voltage Regulation (AVR) Function

Control Mode **VF** **VFP** **SVC** **FOCP** **TQCP** **FOCP** Factory Setting: 0

Settings 0: Enable AVR

1: Disable AVR

2: Disable AVR when deceleration stop

- 📖 It is used to select the AVR mode. AVR is used to regulate the output voltage to the motor. For example, if V/f curve is set to AC200V/50Hz and the input voltage is from 200 to 264VAC, the output voltage won't excess AC200V/50Hz. If the input voltage is from 180 to 200V, the output voltage to the motor and the input voltage will be in direct proportion.
- 📖 When setting Pr.00-13 to 1 during ramp to stop and used with auto accel. / decel. function, the acceleration will be smoother and faster.

↗ **00-14** Source of the Master Frequency Command

Control Mode **VF** **VFPG** **SVC** **FOCPG** **FOCPM** Factory Setting:1

- Settings 1: RS-485 serial communication or digital keypad (KPC-CC01)
 2: External analog input (Pr. 03-00)
 3: Digital terminals input (Pr.04-00~04-15)
 4: Direct docking mode only, contact Delta for more information. ◆

📖 This parameter determines the drive's master frequency source.

↗ **00-15** Source of the Operation Command

Control Mode **VF** **VFPG** **SVC** **FOCPG** **TQCPG** **FOCPM** Factory Setting:1

- Settings 1: External terminals
 2: RS-485 serial communication or digital keypad (KPC-CC01)

📖 ED series is shipped without digital keypad and users can use external terminals or RS-485 to control the operation command.

📖 When the LED PU is light, the operation command can be controlled by the optional digital keypad (KPC-CC01).

01 Basic Parameters

01-00 Maximum Output Frequency

Control Mode **VF** **VFP** **SVC** **FOCPG** **TQCPG** **FOCPM** Factory
 Setting:60.00/50.00

Settings 10.00~400.00Hz

This parameter determines the AC motor drive's Maximum Output Frequency. All the AC motor drive frequency command sources (analog inputs -10V to +10V) are scaled to correspond to the output frequency range.

01-01 1st Output Frequency Setting (base frequency/ motor's rated frequency)

Control Mode **VF** **VFP** **SVC** **FOCPG** **TQCPG** **FOCPM** Factory Setting:60.00/50.00

Settings 0.00~400.00Hz

This value should be set according to the rated frequency of the motor as indicated on the motor nameplate. If the motor is 60Hz, the setting should be 60Hz. If the motor is 50Hz, it should be set to 50Hz.

01-02 1st Output Voltage Setting(base voltage/ motor's rated voltage)

Control Mode **VF** **VFP** **SVC** **FOCPG** **TQCPG** **FOCPM** Factory
 Setting:220.0/440.0

Settings 230V series 0.1~255.0V
 460V series 0.1~510.0V

This value should be set according to the rated voltage of the motor as indicated on the motor nameplate. If the motor is 220V, the setting should be 220.0. If the motor is 200V, it should be set to 200.0.

There are many motor types in the market and the power system for each country is also difference. The economic and convenience method to solve this problem is to install the AC motor drive. There is no problem to use with the different voltage and frequency and also can amplify the original characteristic and life of the motor.

01-03 2nd Output Frequency Setting

Control Mode **VF** **VFP** Factory Setting:0.50

Settings 0.00~400.00Hz

01-04 2nd Output Voltage Setting

Control Mode **VF** **VFP** Factory Setting:5.0/10.0

Settings 230V series 0.1~255.0V
 460V series 0.1~510.0V

01-05 3rd Output Frequency Setting

Control Mode **VF** **VFP** Factory Setting:0.50

Settings 0.00~400.00Hz

01-06 3rd Output Voltage Setting

Control Mode **VF** **VFP** Factory Setting:5.0/10.0

Settings 230V series 0.1~255.0V
 460V series 0.1~510.0V

01-07 4th Output Frequency Setting

Control Mode **VF** **VFP** **SVC** **FOCPG** **TQCPG** Factory Setting:0.00

Settings 0.00~400.00Hz

01-08 4th Output Voltage Setting

Control Mode **VF** **VFP** Factory Setting:5.0/10.0

Settings 230V series 0.1~255.0V
460V series 0.1~510.0V

- V/f curve setting is usually set by the motor's allowable loading characteristics. Pay special attention to the motor's heat dissipation, dynamic balance, and bearing lubricity, if the loading characteristics exceed the loading limit of the motor.
- For the V/f curve setting, it should be $Pr.01-01 \geq Pr.01-03 \geq Pr.01-05 \geq Pr.01-07$. There is no limit for the voltage setting, but a high voltage at the low frequency may cause motor damage, overheat, stall prevention or over-current protection. Therefore, please use the low voltage at the low frequency to prevent motor damage.

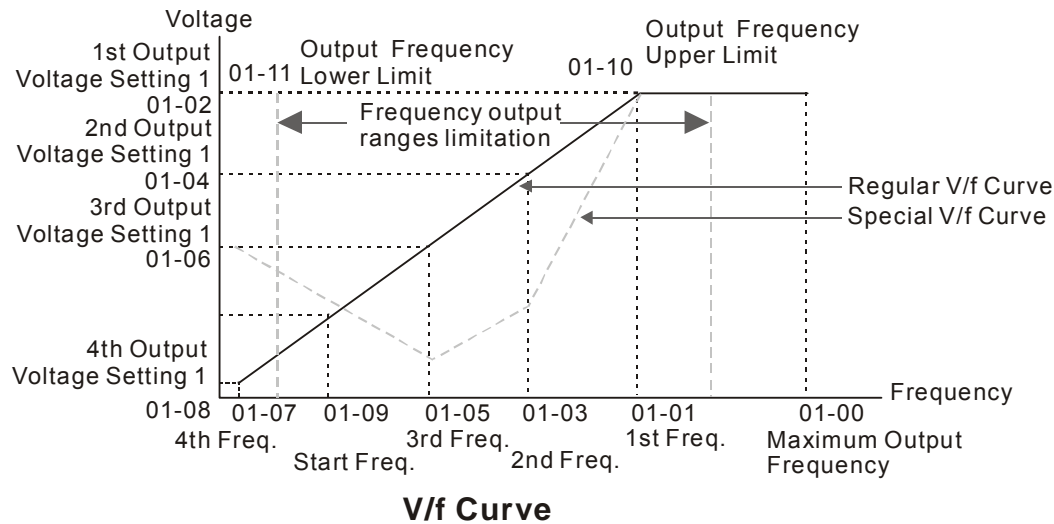

01-09 Starting Frequency

Control Mode **VF** **VFPG** **SVC** **FOCPG** **FOCPM** Factory Setting:0.50

Settings 0.00~400.00Hz

- When the starting frequency (Pr01-09) is larger than the output frequency (Pr01-11), the frequency output will start when the starting frequency (Pr01-09) reached the F command.

When min. output frequency > start frequency When start frequency > min. output frequency

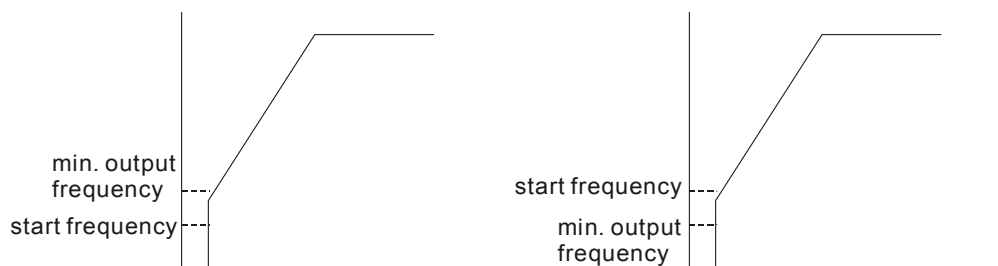

01-10 Output Frequency Upper Limit

Control Mode **VF** **VFPG** **SVC** **FOCPG** **FOCPM** Factory Setting:120.00

Settings 0.00~400.00Hz





01-11 Output Frequency Lower Limit

Control Mode **VF** **VFPG** **SVC** **FOCPG** **FOCPM** Factory Setting:0.00

Settings 0.00~400.00Hz

- The upper/lower output frequency setting is used to limit the actual output frequency. If the frequency setting is lower than the start-up frequency, it will run with zero speed. If the frequency setting is higher than the upper limit, it will runs with the upper limit frequency. If output frequency lower limit > output frequency upper limit, this function is invalid.

↗	01-12	Accel. Time 1					
	Control Mode	VF	VFPG	SVC	FOCPG	FOCPM	Factory Setting:3.00
	Settings	0.00~600.00sec					
↗	01-13	Decel. Time 1					
	Control Mode	VF	VFPG	SVC	FOCPG	FOCPM	Factory Setting:2.00
	Settings	0.00~600.00sec					
↗	01-14	Accel. Time 2					
	Control Mode	VF	VFPG	SVC	FOCPG	FOCPM	Factory Setting:3.00
	Settings	0.00~600.00sec					
↗	01-15	Decel. Time 2					
	Control Mode	VF	VFPG	SVC	FOCPG	FOCPM	Factory Setting:2.00
	Settings	0.00~600.00sec					
↗	01-16	Accel. Time 3					
	Control Mode	VF	VFPG	SVC	FOCPG	FOCPM	Factory Setting:3.00
	Settings	0.00~600.00sec					
↗	01-17	Decel. Time 3					
	Control Mode	VF	VFPG	SVC	FOCPG	FOCPM	Factory Setting:2.00
	Settings	0.00~600.00sec					
↗	01-18	Accel. Time 4					
	Control Mode	VF	VFPG	SVC	FOCPG	FOCPM	Factory Setting:3.00
	Settings	0.00~600.00sec					
↗	01-19	Decel. Time 4					
	Control Mode	VF	VFPG	SVC	FOCPG	FOCPM	Factory Setting:2.00
	Settings	0.00~600.00sec					

-  The Acceleration Time is used to determine the time required for the AC motor drive to ramp from 0Hz to Maximum Output Frequency (Pr.01-00).
-  The Deceleration Time is used to determine the time require for the AC motor drive to decelerate from the Maximum Output Frequency (Pr.01-00) down to 0Hz.
-  The Acceleration/Deceleration Time 1, 2, 3, 4 are selected according to the Multi-function Input Terminals settings. The factory settings are acceleration time 1 and deceleration time 1.
-  The larger against torque and inertia torque of the load and the accel./ decel. time setting is less than the necessary value, it will enable torque limit and stall prevention function. When it happens, actual accel./decel. time will be longer than the action above.

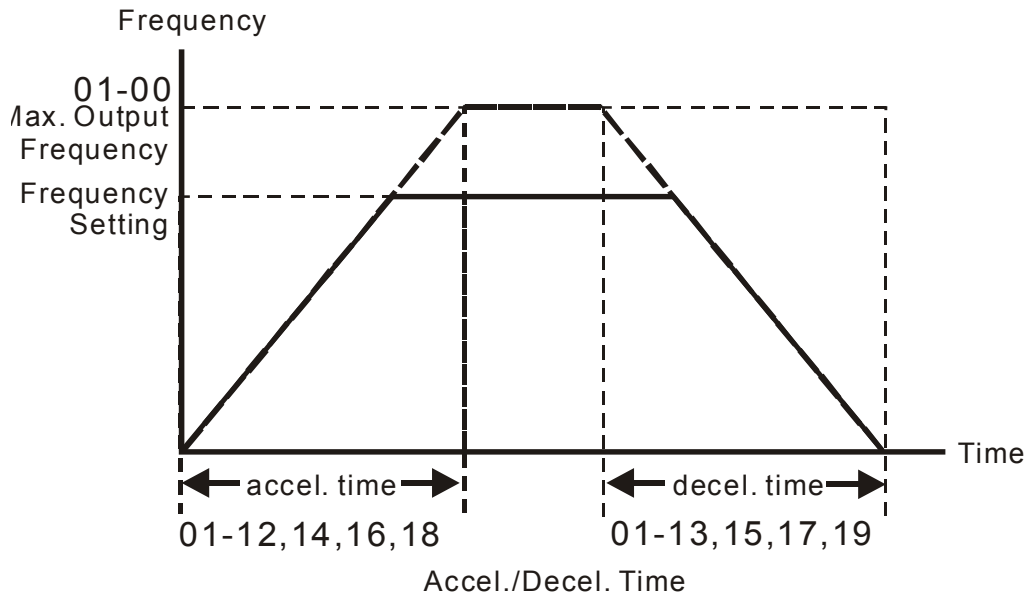

- **01-20** JOG Acceleration Time
- **01-21** JOG Deceleration Time

Control Mode **VF VFPG SVC FOCPG FOCPM** Factory Setting:1.00
 Settings 0.00~600.00sec

- 📖 Both external terminal JOG and key “JOG” on the keypad can be used. When the jog command is ON, the AC motor drive will accelerate from 0Hz (Pr01-07) to jog frequency (Pr.01-22). When the jog command is OFF, the AC motor drive will decelerate from Jog Frequency to zero. The used Accel./ Decel. time is set by the Jog Accel./ Decel. time (Pr.01-20, Pr.01-21).
- 📖 The JOG command can't be executed when the AC motor drive is running. In the same way, when the JOG command is executing, other operation commands are invalid except forward/reverse commands and STOP key on the digital keypad.

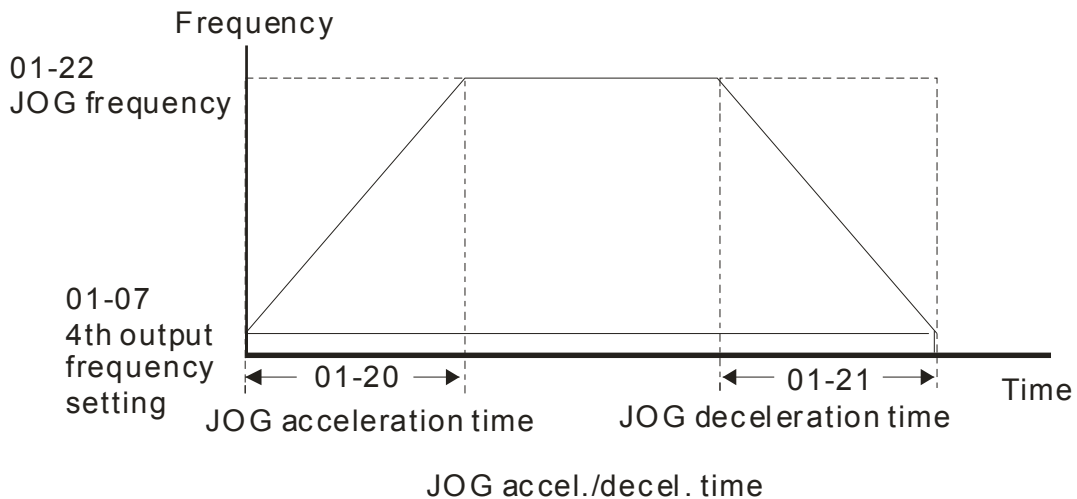

- **01-22** JOG Frequency
- Control Mode **VF VFPG SVC FOCPG TQCPG FOCPM** Factory Setting:6.00
 Settings 0.00~400.00Hz

➤ **01-23** Switch Frequency between 1st/4th Accel/ decel

Control Mode **VF** **VFPG** **SVC** **FOCPG** **FOCPM** Factory Setting:0.00
 Settings 0.00~400.00Hz

- 📖 This parameter selects the frequency point for transition from acceleration/deceleration time 1 to acceleration/deceleration time 4.
- 📖 The transition from acceleration/deceleration time 1 to acceleration/deceleration time 4, may also be enabled by the external terminals (Pr. 02-01 to 02-08). The external terminal has priority over Pr. 01-23.

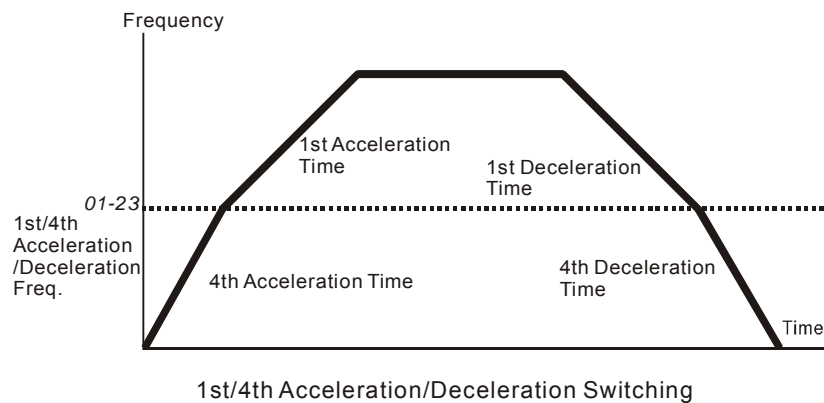

➤ **01-24** S-curve for Acceleration Departure Time S1

➤ **01-25** S-curve for Acceleration Arrival Time S2

➤ **01-26** S-curve for Deceleration Departure Time S3

➤ **01-27** S-curve for Deceleration Arrival Time S4

➤ **01-30** S-curve for Deceleration Arrival Time S5

Control Mode **VF** **VFPG** **SVC** **FOCPG** **FOCPM** Factory Setting:1.00
 Settings 0.00~25.00sec

➤ **01-29** Switch Frequency for S3/S4 Changes to S5

Control Mode **VF** **VFPG** **SVC** **FOCPG** **FOCPM** Factory Setting:0.00
 Settings 0.00~400.00Hz

📖 It is used to give the smoothest transition between speed changes. The accel./ decel. curve can adjust the S-curve of the accel./decel. When it is enabled, the drive will have different accel./decel. curve by the accel./ decel. time.

📖 The Actual Accel. Time = selected accel. Time + (Pr.01-24 + Pr.01-25)/2

The Actual Decel. Time = selected decel. Time + (Pr.01-26 + Pr.01-27 + Pr.01-30*2)/2

📖 Pr.01-29 is used to set the switch frequency between S4 and S5 for smooth stop.

📖 It is recommended to set this parameter to the leveling speed of elevator.

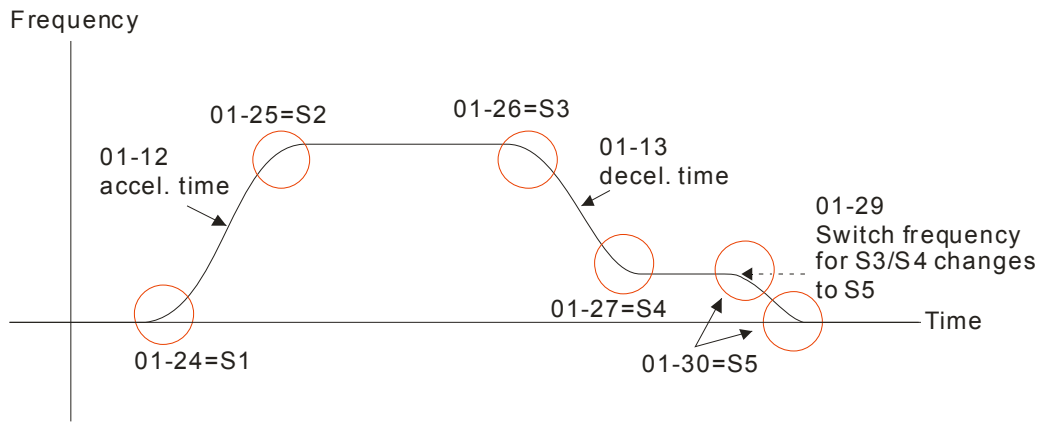

01-28 Mode Selection when Frequency < Fmin

Control Mode **VF** **VFP** **SVC** Factory Setting:1

- Settings 0: Output Waiting
 1: Zero-speed operation
 2: Fmin (4th output frequency setting)

- 📖 When the AC motor drive is at 0Hz, it will operate by this parameter.
- 📖 When it is set to 1 or 2, voltage will be output by Fmin corresponding output voltage (Pr.01-08).

⚡ **01-31** Deceleration Time when Operating without RUN Command

Control Mode **VF** **VFP** **SVC** **FOCP** **FOCPM** Factory Setting:2.00

Settings 0.00~600.00sec

- 📖 The AC motor drive will stop by the setting of this parameter when canceling RUN command. Refer to the figure in Pr.01-29 for details.

⚡ **01-32** Direct docking mode only ◆

Control Mode **VF** **VFP** **SVC** **FOCP** **FOCPM** Factory Setting:

Settings Contact Delta for more information

02 Digital Input/ Output Parameters

02-00

2-wire/3-wire Operation Control

Control Mode **VF** **VFP** **SVC** **FOCP** **TQCP** **FOCP**

Factory Setting: 0

- Settings
- 0: FWD/STOP, REV/STOP
 - 1: FWD/STOP, REV/STOP (Line Start Lockout)
 - 2: RUN/STOP, REV/FWD
 - 3: RUN/STOP, REV/FWD (Line Start Lockout)
 - 4: 3-wire
 - 5: 3-wire (Line Start Lockout)

- ☰ Three of the six methods include a “Line Start Lockout” feature. When line start lockout is enabled, the drive will not run once applying the power. The Line Start Lockout feature doesn’t guarantee the motor will never start under this condition. It is possible the motor may be set in motion by a malfunctioning switch.
- ☰ This parameter is used to control operation from external terminals. There are three different control modes.

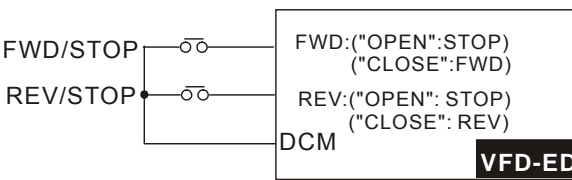
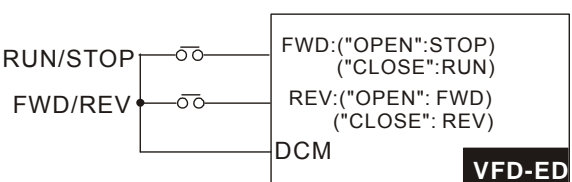
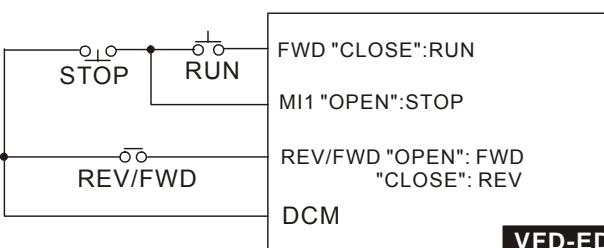
02-00	Control Circuits of the External Terminal
<p>0, 1 2-wire operation control (1) FWD/STOP REV/STOP</p>	
<p>2, 3 2-wire operation control (2) RUN/STOP REV/FWD</p>	
<p>4, 5 3-wire operation control</p>	

02-01	Multi-Function Input Command 1 (MI1) (it is Stop terminal for 3-wire operation)	Factory Setting:1
02-02	Multi-Function Input Command 2 (MI2)	Factory Setting:2
02-03	Multi-Function Input Command 3 (MI3)	Factory Setting:3
02-04	Multi-Function Input Command 4 (MI4)	Factory Setting:4
02-05	Multi-Function Input Command 5 (MI5)	Factory Setting: 0
02-06	Multi-Function Input Command 6 (MI6)	Factory Setting: 0
02-07	Multi-Function Input Command 7 (MI7)	Factory Setting: 0
02-08	Multi-Function Input Command 8 (MI8) When JP1 on the control board is inserted, MI8 functions acc. to Pr02-08. When JP1 on the control board is removed, MI8 is always "enable", independent of Pr02-08.	Factory Setting:40

Settings	Control Mode	VF	VFPG	SVC	FOCPG	TQCPG	FOCPM
0:0: no function		<input type="radio"/>	<input type="radio"/>	<input type="radio"/>	<input type="radio"/>	<input type="radio"/>	<input type="radio"/>
1: multi-step speed command 1		<input type="radio"/>	<input type="radio"/>	<input type="radio"/>	<input type="radio"/>		<input type="radio"/>
2: multi-step speed command 2		<input type="radio"/>	<input type="radio"/>	<input type="radio"/>	<input type="radio"/>		<input type="radio"/>
3: multi-step speed command 3		<input type="radio"/>	<input type="radio"/>	<input type="radio"/>	<input type="radio"/>		<input type="radio"/>
4: multi-step speed command 4		<input type="radio"/>	<input type="radio"/>	<input type="radio"/>	<input type="radio"/>		<input type="radio"/>
5: Reset		<input type="radio"/>	<input type="radio"/>	<input type="radio"/>	<input type="radio"/>	<input type="radio"/>	<input type="radio"/>
6: JOG command		<input type="radio"/>	<input type="radio"/>	<input type="radio"/>	<input type="radio"/>		<input type="radio"/>
7: acceleration/deceleration speed inhibit		<input type="radio"/>	<input type="radio"/>	<input type="radio"/>	<input type="radio"/>		<input type="radio"/>
8: the 1st, 2nd acceleration/deceleration time selection		<input type="radio"/>	<input type="radio"/>	<input type="radio"/>	<input type="radio"/>		<input type="radio"/>
9: the 3rd, 4th acceleration/deceleration time selection		<input type="radio"/>	<input type="radio"/>	<input type="radio"/>	<input type="radio"/>		<input type="radio"/>
10: EF input (07-28)		<input type="radio"/>	<input type="radio"/>	<input type="radio"/>	<input type="radio"/>	<input type="radio"/>	<input type="radio"/>
11: Reserved							
12: Stop output		<input type="radio"/>	<input type="radio"/>	<input type="radio"/>	<input type="radio"/>	<input type="radio"/>	<input type="radio"/>
13~14: Reserved							
15: AUI1 operation speed command form AUI1		<input type="radio"/>	<input type="radio"/>	<input type="radio"/>	<input type="radio"/>		<input type="radio"/>
16: Reserved		<input type="radio"/>	<input type="radio"/>	<input type="radio"/>	<input type="radio"/>		<input type="radio"/>
17: AUI2 operation speed command form AUI2		<input type="radio"/>	<input type="radio"/>	<input type="radio"/>	<input type="radio"/>		<input type="radio"/>
18: Emergency Stop (07-28)		<input type="radio"/>	<input type="radio"/>	<input type="radio"/>	<input type="radio"/>	<input type="radio"/>	<input type="radio"/>
19~23: Reserved							

24: FWD JOG Command	<input type="radio"/>	<input type="radio"/>	<input type="radio"/>	<input type="radio"/>	<input type="radio"/>	<input type="radio"/>
25: REV JOG Command	<input type="radio"/>	<input type="radio"/>	<input type="radio"/>	<input type="radio"/>	<input type="radio"/>	<input type="radio"/>
26: Reserved						
27: ASR1/ASR2 selection	<input type="radio"/>	<input type="radio"/>	<input type="radio"/>	<input type="radio"/>	<input type="radio"/>	<input type="radio"/>
28: Emergency stop (EF1) (Motor coasts to stop)	<input type="radio"/>	<input type="radio"/>	<input type="radio"/>	<input type="radio"/>	<input type="radio"/>	<input type="radio"/>
29~30: Reserved						
31: High torque bias (by Pr.07-21)	<input type="radio"/>	<input type="radio"/>	<input type="radio"/>	<input type="radio"/>	<input type="radio"/>	<input type="radio"/>
32: Middle torque bias (by Pr.07-22)	<input type="radio"/>	<input type="radio"/>	<input type="radio"/>	<input type="radio"/>	<input type="radio"/>	<input type="radio"/>
33: Low torque bias (by Pr.07-23)	<input type="radio"/>	<input type="radio"/>	<input type="radio"/>	<input type="radio"/>	<input type="radio"/>	<input type="radio"/>
34~37: Reserved						
38: Disable write EEPROM function	<input type="radio"/>	<input type="radio"/>	<input type="radio"/>	<input type="radio"/>	<input type="radio"/>	<input type="radio"/>
39: Torque command direction					<input type="radio"/>	
40: Enable drive function	<input type="radio"/>	<input type="radio"/>	<input type="radio"/>	<input type="radio"/>	<input type="radio"/>	<input type="radio"/>
41: Detection of magnetic contactor		<input type="radio"/>	<input type="radio"/>	<input type="radio"/>	<input type="radio"/>	<input type="radio"/>
42: Mechanical brake 1	<input type="radio"/>	<input type="radio"/>	<input type="radio"/>	<input type="radio"/>	<input type="radio"/>	<input type="radio"/>
43: EPS function (Emergency Power System)	<input type="radio"/>	<input type="radio"/>	<input type="radio"/>	<input type="radio"/>	<input type="radio"/>	<input type="radio"/>
44: Mechanical brake 2	<input type="radio"/>	<input type="radio"/>	<input type="radio"/>	<input type="radio"/>	<input type="radio"/>	<input type="radio"/>
45~51: Direct docking mode only ◆						

 This parameter selects the functions for each multi-function terminal.

 If Pr.02-00 is set to 3-wire operation control. Terminal MI1 is for STOP terminal. Therefore, MI1 is not allowed for any other operation.

Settings	Functions	Descriptions
0	No Function	
1	Multi-step speed command 1	15 step speeds could be conducted through the digital statuses of the 4 terminals, and 17 in total if the master speed and JOG are included. (Refer to Pr. 04-00~04-14) When using communication to control the multi-step speed, setting 1 to 4 will be invalid.
2	Multi-step speed command 2	
3	Multi-step speed command 3	
4	Multi-step speed command 4	
5	Reset	After the error of the drive is eliminated, use this terminal to reset the drive.
6	JOG Command	JOG operation
7	Acceleration/deceleration Speed Inhibit	When this function is enabled, acceleration and deceleration is stopped and the AC motor drive starts to accel./decel. from the inhibit point.

8	The 1 st , 2 nd acceleration or deceleration time selection	The acceleration/deceleration time of the drive could be selected from this function or the digital statuses of the terminals; there are 4 acceleration/deceleration speeds in total for selection.									
		<table border="1"> <thead> <tr> <th>Bit</th> <th>Bit</th> <th>Descriptions</th> </tr> </thead> <tbody> <tr> <td>0</td> <td>1</td> <td></td> </tr> <tr> <td>0</td> <td>0</td> <td>First acceleration/deceleration time</td> </tr> </tbody> </table> <p>When output frequency is less than Pr.01-23 (Switch Frequency between 1st/4th Accel/decel), it will output 4th accel/decel time.</p>	Bit	Bit	Descriptions	0	1		0	0	First acceleration/deceleration time
Bit	Bit	Descriptions									
0	1										
0	0	First acceleration/deceleration time									
9	The 3 rd , 4 th acceleration or deceleration time selection	<table border="1"> <tbody> <tr> <td>0</td> <td>1</td> <td>2nd accel./decel. time</td> </tr> <tr> <td>1</td> <td>0</td> <td>3rd accel./decel. time</td> </tr> <tr> <td>1</td> <td>1</td> <td>4th accel./decel. time</td> </tr> </tbody> </table> <p>If the drive receives STOP command, it will decelerate to stop by Pr.01-31.</p>	0	1	2 nd accel./decel. time	1	0	3 rd accel./decel. time	1	1	4 th accel./decel. time
0	1	2 nd accel./decel. time									
1	0	3 rd accel./decel. time									
1	1	4 th accel./decel. time									
10	EF Input	External fault input terminal and decelerates by Pr.07-28. (EF fault will be recorded)									
11: Reserved											
12	Stop output	When this function is enabled, the drive output will stop immediately and the motor is free run. When this function is disabled, the drive will accelerate to the frequency setting.									
13~14: Reserved											
15	Operation speed command form AUI1	<p>When the source of operation speed command is set to AUI1, ACI and AUI2 at the same time and two or above terminals are ON, the priority is AUI1>ACI>AUI2.</p> <p>When this function is enabled, the source of the frequency will force to be AUI1.</p>									
16: Reserved											
17	Operation speed command form AUI2	When this function is enabled, the source of the frequency will force to be AUI2.									
18	Emergency Stop	When this function is enabled, the drive will ramp to stop by Pr.07-28 setting.									
19~23: Reserved											
24	FWD JOG command	When this function is enabled, the drive will execute forward Jog command.									
25	REV JOG command	When this function is enabled, the drive will execute reverse Jog command.									
26: Reserved											
27	ASR1/ASR2 selection	ON: speed will be adjusted by ASR 2 setting. OFF: speed will be adjusted by ASR 1 setting.									
28	Emergency stop (EF1) (Motor coasts to stop)	When it is ON, the drive will execute emergency stop. (it will have fault code record)									

29~30: Reserved																																						
31	High torque bias	<p>When Pr.07-19 is set to 3:</p> <p>The high torque bias is according to the Pr.07-21 setting.</p> <p>The middle torque bias is according to the Pr.07-22 setting.</p> <p>The low torque bias is according to the Pr.07-23 setting.</p> <table border="1"> <thead> <tr> <th>31</th> <th>32</th> <th>33</th> <th>Torque Bias</th> </tr> </thead> <tbody> <tr> <td>OFF</td> <td>OFF</td> <td>OFF</td> <td>N/A</td> </tr> <tr> <td>OFF</td> <td>OFF</td> <td>ON</td> <td>07-23</td> </tr> <tr> <td>OFF</td> <td>ON</td> <td>OFF</td> <td>07-22</td> </tr> <tr> <td>OFF</td> <td>ON</td> <td>ON</td> <td>07-23+07-22</td> </tr> <tr> <td>ON</td> <td>OFF</td> <td>OFF</td> <td>07-21</td> </tr> <tr> <td>ON</td> <td>OFF</td> <td>ON</td> <td>07-21+07-23</td> </tr> <tr> <td>ON</td> <td>ON</td> <td>OFF</td> <td>07-21+07-22</td> </tr> <tr> <td>ON</td> <td>ON</td> <td>ON</td> <td>07-21+07-22+07-23</td> </tr> </tbody> </table>	31	32	33	Torque Bias	OFF	OFF	OFF	N/A	OFF	OFF	ON	07-23	OFF	ON	OFF	07-22	OFF	ON	ON	07-23+07-22	ON	OFF	OFF	07-21	ON	OFF	ON	07-21+07-23	ON	ON	OFF	07-21+07-22	ON	ON	ON	07-21+07-22+07-23
31	32		33	Torque Bias																																		
OFF	OFF		OFF	N/A																																		
OFF	OFF	ON	07-23																																			
OFF	ON	OFF	07-22																																			
OFF	ON	ON	07-23+07-22																																			
ON	OFF	OFF	07-21																																			
ON	OFF	ON	07-21+07-23																																			
ON	ON	OFF	07-21+07-22																																			
ON	ON	ON	07-21+07-22+07-23																																			
32	Middle torque bias																																					
33	Low torque bias																																					
34~37: Reserved																																						
38	Disable write EEPROM function	When this function is enabled, you can't write into EEPROM.																																				
39	Torque command direction	When this function is enabled, you can't write into EEPROM.																																				
40	Enable drive function	When Pr.07-13=2 and analog input is ACI or unipolar AUI, torque command direction is decided by this terminal.																																				
41	Detection of magnetic contactor	When this function is enabled, the drive function can be executed. This function can be used with multi-function output (setting Pr.02-11~Pr.02-14 to 15) and (Pr.02-31 and Pr.02-32).																																				
42	Mechanical brake 1	<p>This terminal is used for the feedback signal of magnetic contactor ON/OFF.</p> <p>When drive receives RUN command, the corresponding output terminal (setting 15) will be enabled after Pr.02-31 time. It will check if this function is enabled within the detection time (Pr.02-36). If NOT, the fault of mechanical brake occurs and fault code "MCF" will be displayed.</p>																																				
43	EPS function (Emergency Power System)	If power is cut during running, the drive will stop when DC bus voltage is less than low voltage level. After power is cut, drive will run by the frequency depend on EPS when EPS is applied and this function is ON.																																				
44	Mechanical brake 2	<p>This terminal is used for the feedback signal of magnetic contactor ON/OFF.</p> <p>When drive receives RUN command, the corresponding output terminal (setting 15) will be enabled after Pr.02-31 time. It will check if this function is enabled within the detection time (Pr.02-36). If NOT, the fault of mechanical brake occurs and fault code "MCF" will be displayed.</p>																																				

45~51	Direct docking mode only ◆	Contact Delta for more information.
-------	-------------------------------	-------------------------------------

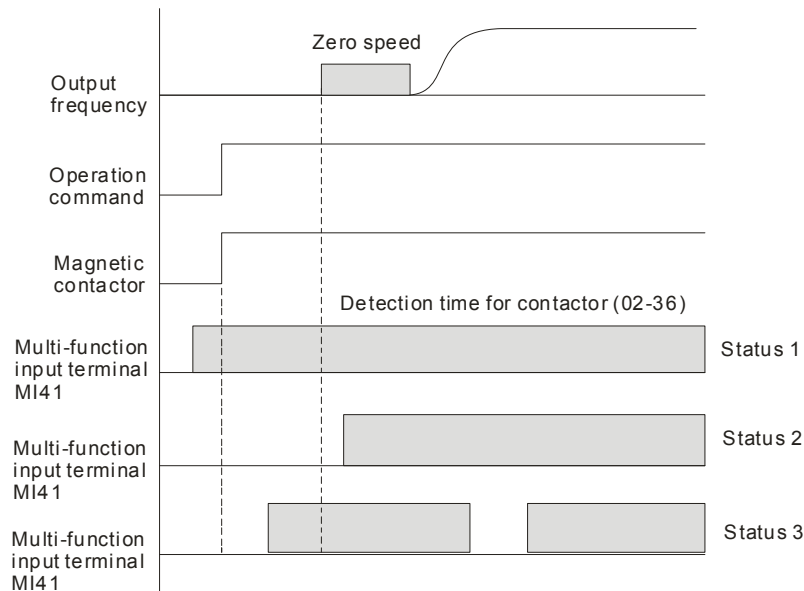
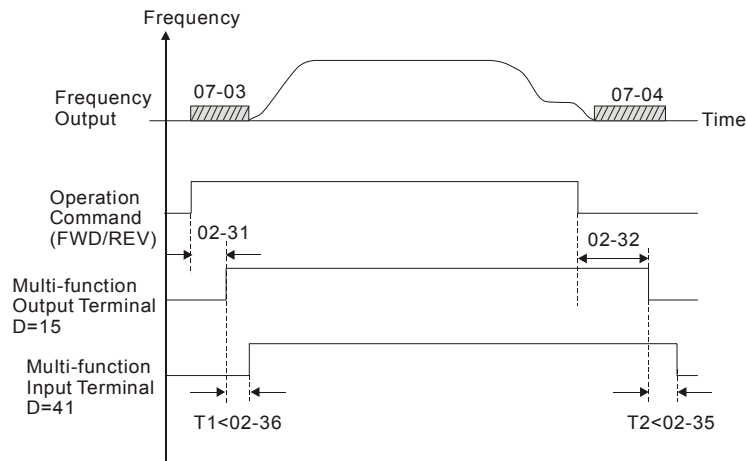

⚡ **02-09** Digital Input Response Time

Control Mode **VF VFPG SVC FOC PG TQCPG FOC PM** Factory Setting: 0.005
 Settings 0.001~30.000sec

📖 This parameter is used for digital input terminal signal delay and confirmation. The delay time is confirmation time to prevent some uncertain interferences that would result in error (except for the counter input) in the input of the digital terminals (FWD, REV and MI1~8). Under this condition, confirmation for this parameter could be improved effectively, but the response time will be somewhat delayed.

⚡ **02-10** Digital Input Operation Direction

Control Mode **VF VFPG SVC FOC PG TQCPG FOC PM** Factory Setting: 0
 Settings 0~65535

📖 This parameter is used to set the input signal level and it won't be affected by the SINK/SOURCE status.
 📖 Bit0 is for FWD terminal, bit1 is for REV terminal and bit2 to bit9 is for MI1 to MI8.

 User can change terminal status by communicating.

For example, MI1 is set to 1 (multi-step speed command 1), MI2 is set to 2 (multi-step speed command 2). Then the forward + 2nd step speed command=1001(binary) =9 (Decimal). Only need to set Pr.02-10=9 by communication and it can forward with 2nd step speed. It doesn't need to wire any multi-function terminal.

bit9	bit8	bit7	bit6	bit5	bit4	bit3	bit2	bit1	bit0
MI8	MI7	MI6	MI5	MI4	MI3	MI2	MI1	REV	FWD

↘	02-11	Multi-function Output 1: RA, RB, RC (Relay 1)	Factory Setting:11
↘	02-12	Multi-function Output 2: MRA, MRB, MRC (Relay 2)	Factory Setting:1
↘	02-13	Multi-function Output 3: R1A, R12C (Realy 3)	
↘	02-14	Multi-function Output 4: R2A, R12C (Realy 4)	
↘	02-15	Multi-function Output 5: MO1	
↘	02-16	Multi-function Output 6: MO2	
↘	02-17	Reserved	
↘	02-18	Reserved	
↘	02-19	Reserved	
↘	02-20	Reserved	
↘	02-21	Reserved	
↘	02-22	Reserved	

Factory Setting: 0

Settings	Control Mode	VF	VFPG	SVC	FOCPG	TQCPG	FOCPM
0: No function		<input type="radio"/>	<input type="radio"/>	<input type="radio"/>	<input type="radio"/>	<input type="radio"/>	<input type="radio"/>
1: Operation indication		<input type="radio"/>	<input type="radio"/>	<input type="radio"/>	<input type="radio"/>	<input type="radio"/>	<input type="radio"/>
2: Operation speed attained		<input type="radio"/>	<input type="radio"/>	<input type="radio"/>	<input type="radio"/>	<input type="radio"/>	<input type="radio"/>
3: Desired frequency attained 1 (Pr.02-25, 02-26)		<input type="radio"/>	<input type="radio"/>	<input type="radio"/>	<input type="radio"/>		<input type="radio"/>
4: Desired frequency attained 2 (Pr.02-27, 02-28)		<input type="radio"/>	<input type="radio"/>	<input type="radio"/>	<input type="radio"/>		<input type="radio"/>
5: Zero Speed(frequency command		<input type="radio"/>	<input type="radio"/>	<input type="radio"/>	<input type="radio"/>		<input type="radio"/>
6: Zero speed with stop (frequency command)		<input type="radio"/>	<input type="radio"/>	<input type="radio"/>	<input type="radio"/>		<input type="radio"/>
7: Over torque (OT1) (Pr.06-05~06-07)		<input type="radio"/>	<input type="radio"/>	<input type="radio"/>	<input type="radio"/>	<input type="radio"/>	<input type="radio"/>
8: Over torque (OT2) (Pr.06-08~06-10)		<input type="radio"/>	<input type="radio"/>	<input type="radio"/>	<input type="radio"/>	<input type="radio"/>	<input type="radio"/>
9: Drive ready		<input type="radio"/>	<input type="radio"/>	<input type="radio"/>	<input type="radio"/>	<input type="radio"/>	<input type="radio"/>
10: User-defined Low-voltage Detection (LV)		<input type="radio"/>	<input type="radio"/>	<input type="radio"/>	<input type="radio"/>	<input type="radio"/>	<input type="radio"/>
11: Malfunction indication		<input type="radio"/>	<input type="radio"/>	<input type="radio"/>	<input type="radio"/>	<input type="radio"/>	<input type="radio"/>
12: Mechanical brake release (Pr.02-29, Pr.02-30)		<input type="radio"/>	<input type="radio"/>	<input type="radio"/>	<input type="radio"/>	<input type="radio"/>	<input type="radio"/>
13: Overheat (Pr.06-14)		<input type="radio"/>	<input type="radio"/>	<input type="radio"/>	<input type="radio"/>	<input type="radio"/>	<input type="radio"/>
14: Brake chopper signal		<input type="radio"/>	<input type="radio"/>	<input type="radio"/>	<input type="radio"/>	<input type="radio"/>	<input type="radio"/>
15: Motor-controlled magnetic contactor output		<input type="radio"/>	<input type="radio"/>	<input type="radio"/>	<input type="radio"/>	<input type="radio"/>	<input type="radio"/>
16: Slip error (oSL)		<input type="radio"/>	<input type="radio"/>	<input type="radio"/>	<input type="radio"/>		<input type="radio"/>
17: Malfunction indication 1		<input type="radio"/>	<input type="radio"/>	<input type="radio"/>	<input type="radio"/>	<input type="radio"/>	<input type="radio"/>
18: Reserved							
19: Brake chopper output error		<input type="radio"/>	<input type="radio"/>	<input type="radio"/>	<input type="radio"/>	<input type="radio"/>	<input type="radio"/>
20: Warning output		<input type="radio"/>	<input type="radio"/>	<input type="radio"/>	<input type="radio"/>	<input type="radio"/>	<input type="radio"/>
21: Over voltage warning		<input type="radio"/>	<input type="radio"/>	<input type="radio"/>	<input type="radio"/>	<input type="radio"/>	<input type="radio"/>
22: Over-current stall prevention warning		<input type="radio"/>	<input type="radio"/>	<input type="radio"/>			
23: Over-voltage stall prevention warning		<input type="radio"/>	<input type="radio"/>	<input type="radio"/>	<input type="radio"/>	<input type="radio"/>	<input type="radio"/>
24: Operation mode indication (Pr.00-15≠0)		<input type="radio"/>	<input type="radio"/>	<input type="radio"/>	<input type="radio"/>	<input type="radio"/>	<input type="radio"/>

25: Forward command	<input type="radio"/>	<input type="radio"/>	<input type="radio"/>	<input type="radio"/>	<input type="radio"/>	<input type="radio"/>
26: Reverse command	<input type="radio"/>	<input type="radio"/>	<input type="radio"/>	<input type="radio"/>	<input type="radio"/>	<input type="radio"/>
27: Output when current \geq Pr.02-33	<input type="radio"/>	<input type="radio"/>	<input type="radio"/>	<input type="radio"/>	<input type="radio"/>	<input type="radio"/>
28: Output when current $<$ Pr.02-33	<input type="radio"/>	<input type="radio"/>	<input type="radio"/>	<input type="radio"/>	<input type="radio"/>	<input type="radio"/>
29: Output when frequency \geq Pr.02-34	<input type="radio"/>	<input type="radio"/>	<input type="radio"/>	<input type="radio"/>	<input type="radio"/>	<input type="radio"/>
30: Output when frequency $<$ Pr.02-34	<input type="radio"/>	<input type="radio"/>	<input type="radio"/>	<input type="radio"/>	<input type="radio"/>	<input type="radio"/>
31: Power generation direction and status verify	<input type="radio"/>	<input type="radio"/>	<input type="radio"/>	<input type="radio"/>	<input type="radio"/>	<input type="radio"/>
32: Power generation direction	<input type="radio"/>	<input type="radio"/>	<input type="radio"/>	<input type="radio"/>	<input type="radio"/>	<input type="radio"/>
33: Zero speed (actual output frequency)	<input type="radio"/>	<input type="radio"/>	<input type="radio"/>	<input type="radio"/>		<input type="radio"/>
34: Zero speed with Stop (actual output frequency)	<input type="radio"/>	<input type="radio"/>	<input type="radio"/>	<input type="radio"/>		<input type="radio"/>
35: Fault output option 1 (Pr.06-22)	<input type="radio"/>	<input type="radio"/>	<input type="radio"/>	<input type="radio"/>	<input type="radio"/>	<input type="radio"/>
36: Fault output option 2 (Pr.06-23)	<input type="radio"/>	<input type="radio"/>	<input type="radio"/>	<input type="radio"/>	<input type="radio"/>	<input type="radio"/>
37: Fault output option 3 (Pr.06-24)	<input type="radio"/>	<input type="radio"/>	<input type="radio"/>	<input type="radio"/>	<input type="radio"/>	<input type="radio"/>
38: Fault output option 4 (Pr.06-25)	<input type="radio"/>	<input type="radio"/>	<input type="radio"/>	<input type="radio"/>	<input type="radio"/>	<input type="radio"/>
39: Reserved						
40: Speed attained (including zero speed)	<input type="radio"/>	<input type="radio"/>	<input type="radio"/>	<input type="radio"/>		<input type="radio"/>
41: Reserved						
42: STO Output Error						
43~44: Direct Docking Mode only \blacklozenge						
45: Reserved						
46: Indicator of Retrying while a fault has occurred						
47: Direct Docking Mode only \blacklozenge						

Settings	Functions	Descriptions
0	No Function	No function
1	AC Drive Operational	Active when there is an output from the drive or RUN command is ON.
2	Operation speed attained	Active when the AC motor drive reaches the output frequency setting.
3	Desired Frequency Attained 1 (Pr.02-25, 02-26)	Active when the desired frequency (Pr.02-25, 02-26) is attained.
4	Desired Frequency Attained 2 (Pr.02-27, 02-28)	Active when the desired frequency (Pr.02-27, 02-28) is attained.
5	Zero Speed (frequency command)	Active when frequency command =0. (the drive should be at RUN mode)
6	Zero Speed with Stop (frequency command)	Active when frequency command =0 or stop.

7	Over Torque (OT1) (Pr.06-05~06-07)	Active when detecting over-torque. Refer to Pr.06-05 (over-torque detection selection-OT1), Pr.06-06 (over-torque detection level-OT1) and Pr.06-07 (over-torque detection time-OT1).
---	------------------------------------	---

8	Over Torque (OT2) (Pr.06-08~06-10)	Active when detecting over-torque. Refer to Pr.06-08 (over-torque detection selection-OT2), Pr.06-09 (over-torque detection level-OT2) and Pr.06-10 (over-torque detection time-OT2).
9	Drive Ready	Active when the drive is ON and no abnormality detected.
10	User-defined Low-voltage Detection	Active when the DC Bus voltage is too low. (refer to Pr.06-00 low voltage level)
11	Malfunction Indication	Active when fault occurs (except Lv stop).
12	Mechanical Brake Release (Pr.02-29, Pr.02-30)	When drive runs after Pr.02-29, it will be ON. This function should be used with DC brake and it is recommended to use contact "b" (N.C).
13	Overheat (Pr.06-14)	Active when IGBT or heat sink overheats to prevent OH turn off the drive. (refer to Pr.06-14)
14	Brake Chopper Signal	The output will be activated when the drive needs help braking the load. A smooth deceleration is achieved by using this function. (refer to Pr.07-00)
15	Motor-controlled Magnetic Contactor Output	Active when the setting is set to 15.
16	Slip Error (oS _L)	Active when the slip error is detected (by Pr.05-14).
17	Malfunction indication 1	Activate after 10ms when fault occurs (except Lv stop).
18	Reserved	
19	Brake Chopper Output Error	Active when the brake chopper error is detected
20	Warning Output	Active when the warning is detected.
21	Over-voltage Warning	Active when the over-voltage is detected.
22	Over-current Stall Prevention Warning	Active when the over-current stall prevention is detected.
23	Over-voltage Stall prevention Warning	Active when the over-voltage stall prevention is detected.
24	Operation Mode Indication	Active when the operation command is controlled by external terminal. (Pr.00-15=1) and PU LED on keypad KPVL-CC01 is OFF.
25	Forward Command	Active when the operation direction is forward.
26	Reverse Command	Active when the operation direction is reverse.
27	Output when Current >= Pr.02-33	Active when current is >= Pr.02-33.
28	Output when Current < Pr.02-33	Active when current is < Pr.02-33.
29	Output when frequency >= Pr.02-34	Active when frequency is >= Pr.02-34.
30	Output when Frequency < Pr.02-34	Active when frequency is < Pr.02-34.
31	Power Generation Direction and Status Verify	Activate when power generation direction is verified.

32	Power Generation Direction	Activate when power generation direction is forward run.											
33	Zero Speed (actual output frequency)	Active when the actual output frequency is 0. (the drive should be at RUN mode)											
34	Zero Speed with Stop (actual output frequency)	Active when the actual output frequency is 0 or Stop. (the drive should be at RUN mode)											
35	Fault output option 1	Active when Pr.06-22 is ON.											
36	Fault output option 2	Active when Pr.06-23 is ON.											
37	Fault output option 3	Active when Pr.06-24 is ON.											
38	Fault output option 4	Active when Pr.06-25 is ON.											
39	Reserved												
40	Speed Attained (including zero speed)	Active when the output frequency reaches frequency setting.											
41	Reserved												
42	STO Output Error	<table border="1"> <tr> <td rowspan="2">Status of Drive</td> <td>Status of Safety Output</td> <td rowspan="4">Setting of Logic Output B is on page 16-6</td> </tr> <tr> <td>Status A (MO=42)</td> </tr> <tr> <td>Normal</td> <td>Broken Circuit(Open)</td> </tr> <tr> <td>STO</td> <td>Short Circuit(Close)</td> </tr> <tr> <td></td> <td>STL1~STL3</td> <td>Short Circuit(Close)</td> </tr> </table>	Status of Drive	Status of Safety Output	Setting of Logic Output B is on page 16-6	Status A (MO=42)	Normal	Broken Circuit(Open)	STO	Short Circuit(Close)		STL1~STL3	Short Circuit(Close)
		Status of Drive		Status of Safety Output		Setting of Logic Output B is on page 16-6							
			Status A (MO=42)										
		Normal	Broken Circuit(Open)										
STO	Short Circuit(Close)												
	STL1~STL3	Short Circuit(Close)											
43~44	Direct Docking Mode only ◆	Contact Delta for more information											
45	Reserved												
46	Indicator of Retrying while a fault has occurred	Re-attempt to do multiple output while an error has occurred. When finish re-attempting, MO will stop.											
47	Direct Docking Mode only ◆`	Contact Delta for more information											

02-23 Multi-output Direction

Control Mode **VF VFPG SVC FOC PG TQCPG FOC PM** Factory Setting: 0
 Settings 0~65535

This parameter is bit setting. If the bit is 1, the multi-function output terminal will be act with opposite direction. For example, if Pr.02-11 is set to 1 and forward bit is 0, Relay 1 will be ON when the drive is running and OFF when the drive is stop.

Bit 11	Bit 10	Bit 9	Bit 8	Bit 7	Bit 6	Bit 5	Bit 4	Bit 3	Bit 2	Bit 1	Bit 0
-	-	-	-	-	-	MO2	MO1	R2A	R1A	MRA	RA

02-24 Serial Start Signal Selection

Control Mode **VF VFPG SVC FOC PG FOC PM** Factory Setting: 0
 Settings 0: By FWD/REV signal
 1: By Enable signal

This parameter is used to select serial start method of electromagnetic valve.

When choose 0: by FWD/REV signal, the motor will start to run after the signal of enabling MI=40 is ON.

When choose 1: by Enable signal, the electromagnetic valve, mechanical brake and DC brake will follow parameters' setting to run after FWD/REV and Enable are ON.

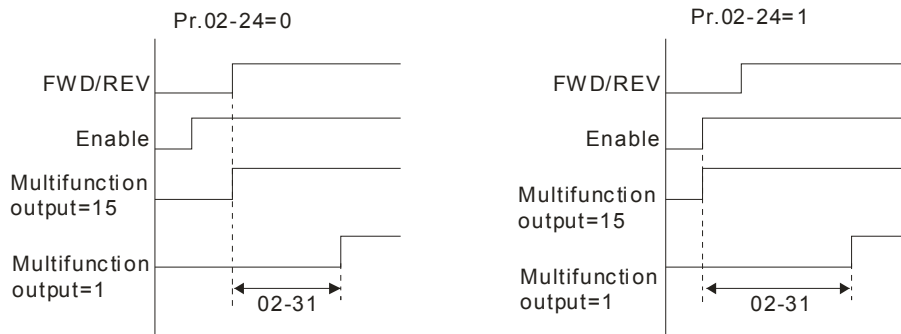
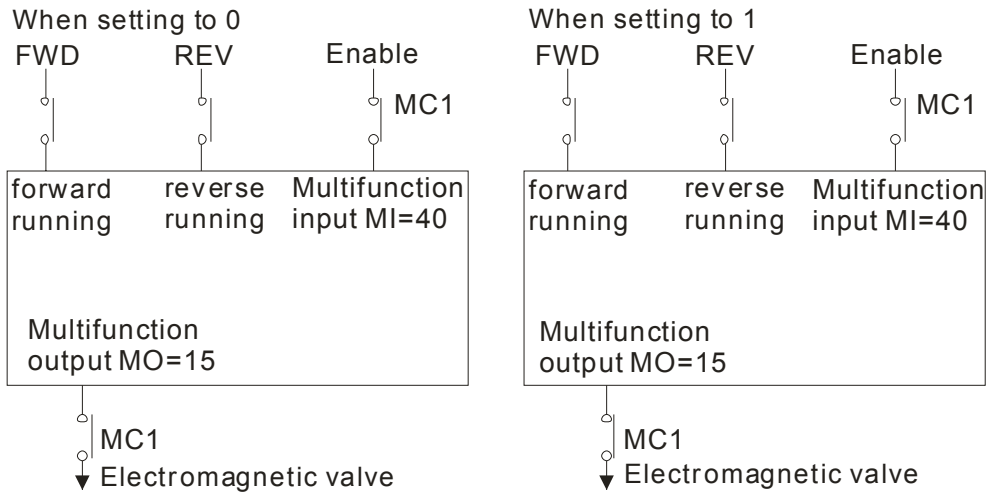

02-25 Desired Frequency Attained 1

Control Mode **VF VFPG SVC FOCPG FOCPM** Factory
 Setting:60.00/50.00
 Settings 0.00~400.00Hz

02-26 The Width of the Desired Frequency Attained 1

Control Mode **VF VFPG SVC FOCPG FOCPM** Factory Setting:2.00
 Settings 0.00~400.00Hz

02-27 Desired Frequency Attained 2

Control Mode **VF VFPG SVC FOCPG FOCPM** Factory
 Setting:60.00/50.00
 Settings 0.00~400.00Hz

02-28 The Width of the Desired Frequency Attained 2

Control Mode **VF VFPG SVC FOCPG FOCPM** Factory Setting:2.00
 Settings 0.00~400.00Hz

Once the output frequency reaches desired frequency and the corresponding multi-function output terminal is set to 3 or 4 (Pr.02-11~Pr.02-22), this multi-function output terminal will be ON.

02-29 Brake Release Delay Time when Elevator Starts

Control Mode **VF VFPG SVC FOCPG TQCPG FOCPM** Factory Setting:0.250
 Settings 0.000~65.000sec

02-30 Brake Engage Delay Time when Elevator Stops

Control Mode **VF VFPG SVC FOCPG TQCPG FOCPM** Factory Setting:0.250
 Settings 0.000~65.000sec

When the AC motor drive runs after the delay time set at Pr02-29, the corresponding multi-function output

terminal (12: mechanical brake release) will be ON.

When the AC motor drive stops and after Pr.02-30 delay time, the corresponding multi-function output terminal (12: mechanical brake release) will be OFF.

This function needs to co-work with DC brake function.

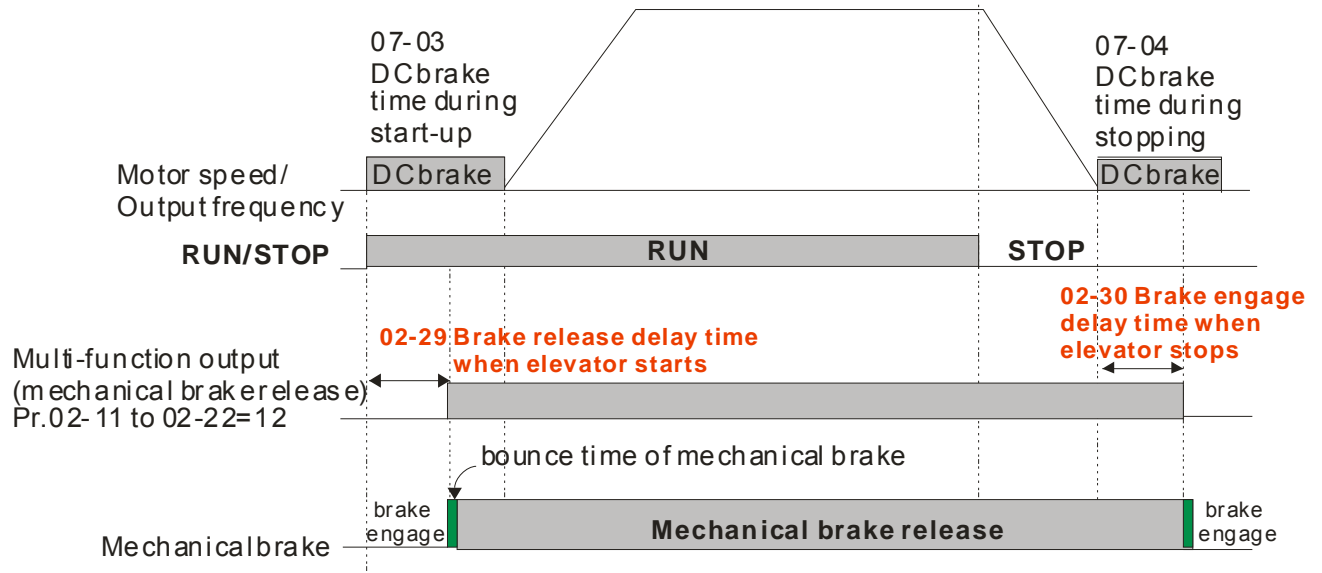

➤ **02-31** Turn On Delay of Magnetic Contact between Drive and Motor

➤ **02-32** Turn Off Delay of Magnetic Contact between Drive and Motor

Control Mode **VF** **VFP** **SVC** **FOCP** **TQCP** **FOCP** Factory Setting:0.20
 Settings 0.010~65.000 sec.

After running, it is used with setting 40 of multifunction input terminal and settings 15 of multifunction output terminals. When multifunction output terminals is ON, the drive starts output after Pr.02-31 delay time. When drive stops output, multifunction output terminals will release after Pr.02-32 delay time.

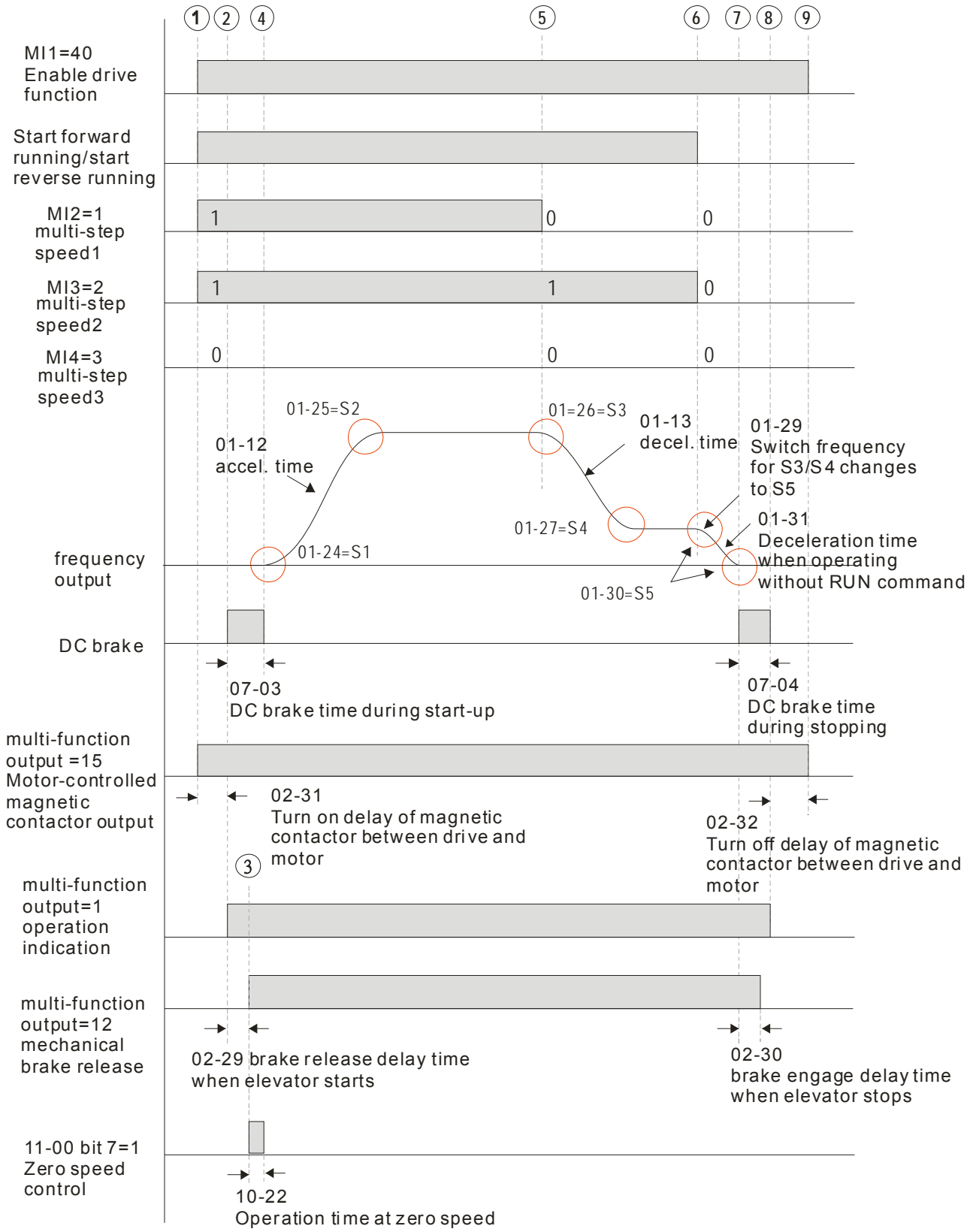

- ① elevator starts running ⑤ start deceleration ⑨ motor release
- ② electromagnet valve is ON ⑥ the end of creep
- ③ brake release ⑦ start DC brake time during stopping
- ④ the end of DC brake time at start-up ⑧ the end of DC brake time during stopping

02-33 Output Current Level Setting for External Terminals
 Control Mode **VF VFPG SVC FOC PG TQCPG FOC PM** Factory Setting: 0
 Settings 0~100%

When output current is \geq Pr.02-33, it will activate multi-function output terminal (Pr.02-11 to Pr.02-22 is set to 27).
 When output current is $<$ Pr.02-33, it will activate multi-function output terminal (Pr.02-11 to Pr.02-22 is set to 28).

02-34 Output Boundary for External Terminals
 Control Mode **VF VFPG SVC FOC PG TQCPG FOC PM** Factory Setting:0.00
 Settings 0.00~ \pm 400.00Hz

When output frequency is \geq 02-34, it will activate the multi-function terminal (Pr.02-11 to Pr.02-22 is set to 29).
 When output frequency is $<$ 02-34, it will activate the multi-function terminal (Pr.02-11 to Pr.02-22 is set to 30).

02-35 Detection Time of Mechanical Brake
 Control Mode **VF VFPG SVC FOC PG TQCPG FOC PM** Factory Setting:0.00
 Settings 0.00~10.00sec

When mechanical brake function (setting 42 of Pr.02-01~02-08) is not enabled within this setting time, it will display fault code 64 (MBF) mechanical brake error.

02-36 Detection Time of Magnetic Contactor
 Control Mode **VF VFPG SVC FOC PG TQCPG FOC PM** Factory Setting:0.00
 Settings 0.00~10.00sec

When mechanical brake function (setting 41 of Pr.02-01~02-08) is not enabled within this setting time, it will display fault code 66 (MCF) mechanical brake error.

02-37 Check Torque Output Function
 Control Mode **VF VFPG SVC FOC PG TQCPG FOC PM** Factory Setting: 0
 Settings 0: Enable
 1: Disable

When the drive receives the operation signal, the drive will check if there is torque output. When this function is enabled, it will release mechanical brake after confirming that there is torque output.

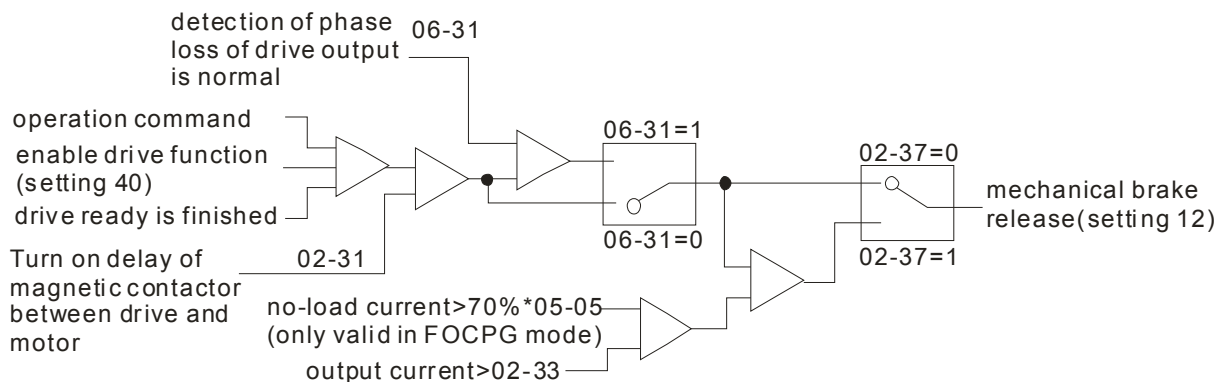

03 Analog Input/ Output Parameters

⚡ **03-00** Analog Input 1 (AUI1) Factory Setting:1

⚡ **03-01** Reserved

⚡ **03-02** Analog Input 2 (AUI2) Factory Setting: 0

Settings	Control Mode	VF	VFPG	SVC	FOCPG	TQCPG	FOCPM
0: No function		<input type="radio"/>	<input type="radio"/>	<input type="radio"/>	<input type="radio"/>	<input type="radio"/>	<input type="radio"/>
1: Frequency command (torque limit under TQR control mode)		<input type="radio"/>	<input type="radio"/>	<input type="radio"/>	<input type="radio"/>	<input type="radio"/>	<input type="radio"/>
2: Torque command (torque limit under speed mode)						<input type="radio"/>	
3: Preload input		<input type="radio"/>	<input type="radio"/>	<input type="radio"/>	<input type="radio"/>	<input type="radio"/>	<input type="radio"/>
4~5: Reserved							
6: P.T.C. thermistor input value		<input type="radio"/>	<input type="radio"/>	<input type="radio"/>	<input type="radio"/>	<input type="radio"/>	<input type="radio"/>
7: Positive torque limit					<input type="radio"/>		<input type="radio"/>
8: Negative torque limit					<input type="radio"/>		<input type="radio"/>
9: Regenerative torque limit					<input type="radio"/>		<input type="radio"/>
10: Positive/negative torque limit					<input type="radio"/>		<input type="radio"/>

- 📖 When it is frequency command or TQR speed limit, the corresponding value for 0~±10V/4~20mA is 0 – max. output frequency(Pr.01-00)
- 📖 When it is torque command or torque limit, the corresponding value for 0~±10V/4~20mA is 0 – max. output torque (Pr.07-14).
- 📖 When it is torque compensation, the corresponding value for 0~±10V/4~20mA is 0 – rated torque.

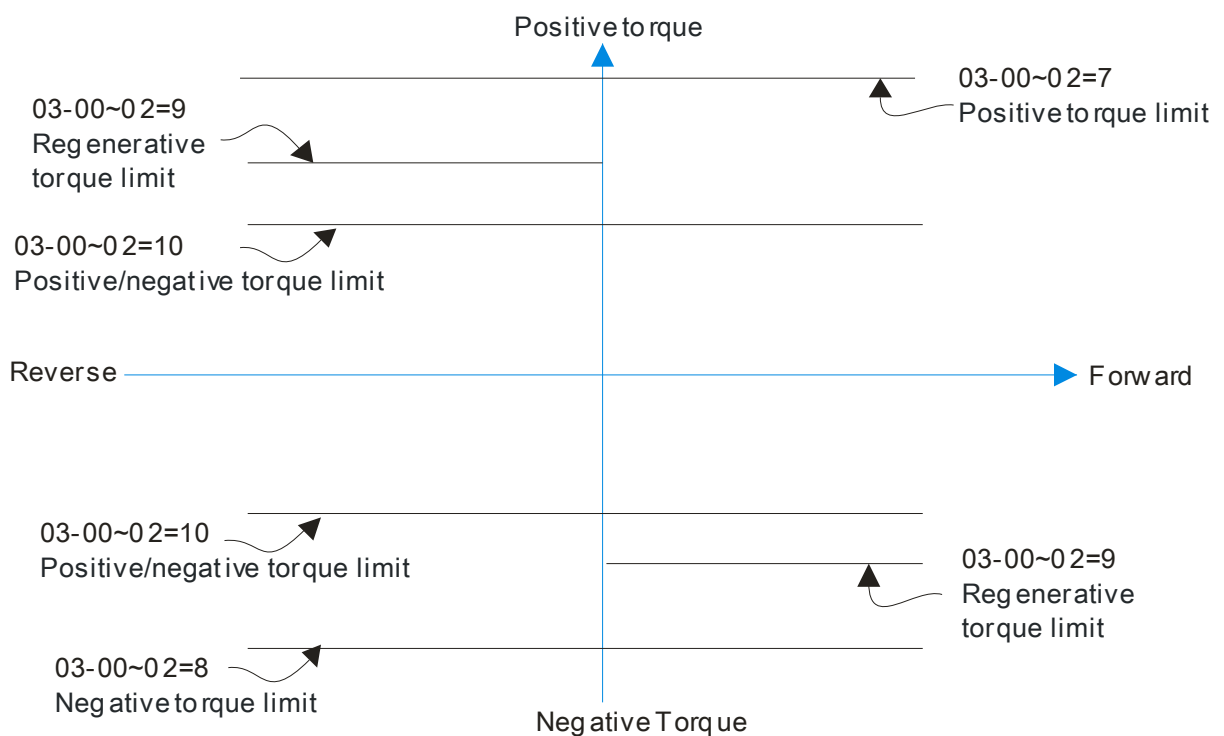

07-19: Source of torque offset
 03-00~02: Analog input selections (AUI1/ACI/AUI2)
 03-03~05: Analog input bias (AUI1/ACI/AUI2)
 03-06~08: AUI1/ACI/AUI2 bias mode

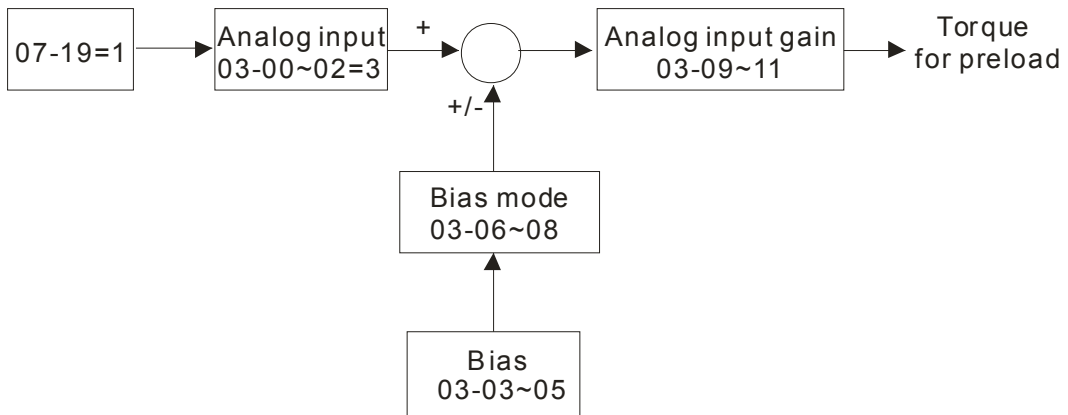

⚡ **03-03** Analog Input Bias 1 (AUI1)

Control Mode **VF** **VFP** **SVC** **FOCPG** **TQCPG** **FOCPM** Factory Setting: 0.0

Settings -100.0~100.0%

📖 It is used to set the corresponding AUI1 voltage of the external analog input 0.

03-04 Reserved

⚡ **03-05** Analog Input Bias 1 (AUI2)

Control Mode **VF** **VFP** **SVC** **FOCPG** **TQCPG** **FOCPM** Factory Setting: 0.0

Settings -100.0~100.0%

📖 It is used to set the corresponding AUI2 voltage of the external analog input 0.

📖 The relation between external input voltage/current and setting frequency is equal to -10~+10V (4-20mA) corresponds to 0-60Hz.

⚡ **03-06** AUI1 Positive/negative Bias Mode (AUI1)

Control Mode **VF** **VFP** **SVC** **FOCPG** **TQCPG** **FOCPM** Factory Setting: 0

03-07 Reserved

⚡ **03-08** Positive/negative Bias Mode (AUI2)

Control Mode **VF** **VFP** **SVC** **FOCPG** **TQCPG** **FOCPM** Factory Setting: 0

Settings 0: Zero bias

1: Serve bias as the center, lower than bias=bias

2: Serve bias as the center, greater than bias=bias

3: The absolute value of the bias voltage while serving as the center (unipolar)

4: Serve bias as the center (unipolar)

📖 In a noisy environment, it is advantageous to use negative bias to provide a noise margin. It is recommended NOT to use less than 1V to set the operating frequency.

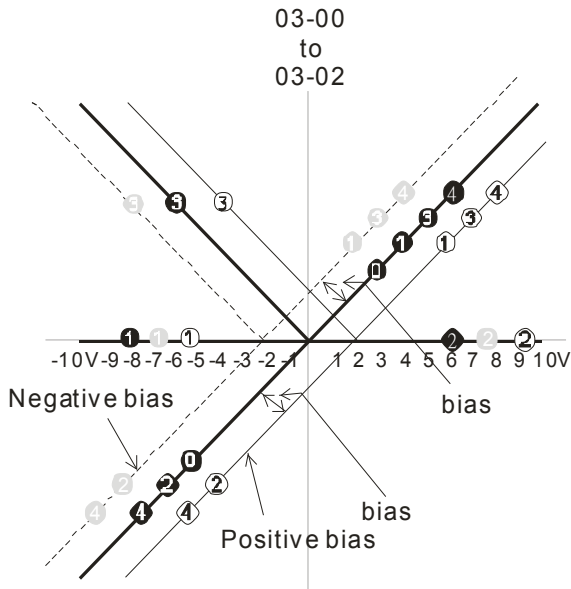

03-09~03-11 gain is positive

- 0 Zero bias
- 1 Serve bias as the center, lower than bias = bias
- 2 Serve bias as the center, greater than bias = bias
- 3 The absolute value of the bias voltage while serving as the center (unipolar)
- 4 Serve bias as the center (unipolar)

⚡ **03-09** Analog Input Gain 1 (AUI1)
 Control Mode **VF VFBG SVC FOC PG TQCPG FOC PM** Factory Setting:100.0
 Settings 0.0~500.0%

03-10 Reserved

⚡ **03-11** Analog Input Gain 1 (AUI2)
 Control Mode **VF VFBG SVC FOC PG TQCPG FOC PM** Factory Setting:100.0
 Settings 0.0~500.0%

📖 Parameters 03-03 to 03-11 are used when the source of frequency command is the analog voltage/current signal.

⚡ **03-12** Analog Input Delay Time (AUI1)
 Control Mode **VF VFBG SVC FOC PG TQCPG FOC PM** Factory Setting:0.01
 Settings 0.00~2.00sec

03-13 Reserved

⚡ **03-14** analog Input Delay Time (AUI2)
 Control Mode **VF VFBG SVC FOC PG TQCPG FOC PM** Factory Setting:0.01
 Settings 0.00~2.00sec

📖 Interferences commonly exist with analog signals, such as those entering AUI, ACI and AUI2. These interferences constantly affect the stability of analog control and using the Input Noise Filter will create a more stable system.

📖 If Pr03-14 is large, the control will be stable, yet the response to the input will be slow. If Pr. 03-14 is small, the control may be unstable, yet the response to the input will be fast.

03-15 Reserved

03-16 Reserved

↗ **03-17** Analog Output Selection 1

↗ **03-20** Analog Output Selection 2

Control Mode **VF** **VFP** **SVC** **FOCPG** **TQCPG** **FOCPM** Factory Setting: 0

- Settings
- 0: Output frequency (Hz)
 - 1: Frequency command (Hz)
 - 2: Motor speed (RPM)
 - 3: Output current (rms)
 - 4: Output voltage
 - 5: DC Bus Voltage
 - 6: Power factor angle
 - 7: Power factor
 - 8: Output torque
 - 9 : AUI1
 - 10: Reserved
 - 11: AUI2
 - 12: q-axis current
 - 13: q-axis feedback value
 - 14: d-axis voltage
 - 15: d-axis feedback value
 - 16: q-axis voltage
 - 17: d-axis voltage
 - 18: Torque command
 - 19~20: Reserved
 - 21: Power output
-

↗ **03-18** Analog Output Gain 1

↗ **03-21** Analog Output Gain 2

Control Mode **VF** **VFP** **SVC** **FOCPG** **TQCPG** **FOCPM** Factory Setting: 100.0

Settings 0~200.0%

 This parameter is set the corresponding voltage of the analog output 0.

↗ **03-19** Analog Output Value in REV Direction 1

↗ **03-22** Analog Output Value in REV Direction 2

Control Mode **VF** **VFP** **SVC** **FOCPG** **TQCPG** **FOCPM** Factory Setting: 0

- Settings
- 0: Absolute value in REV direction
 - 1: Output 0V in REV direction
 - 2: Enable output voltage in REV direction
-

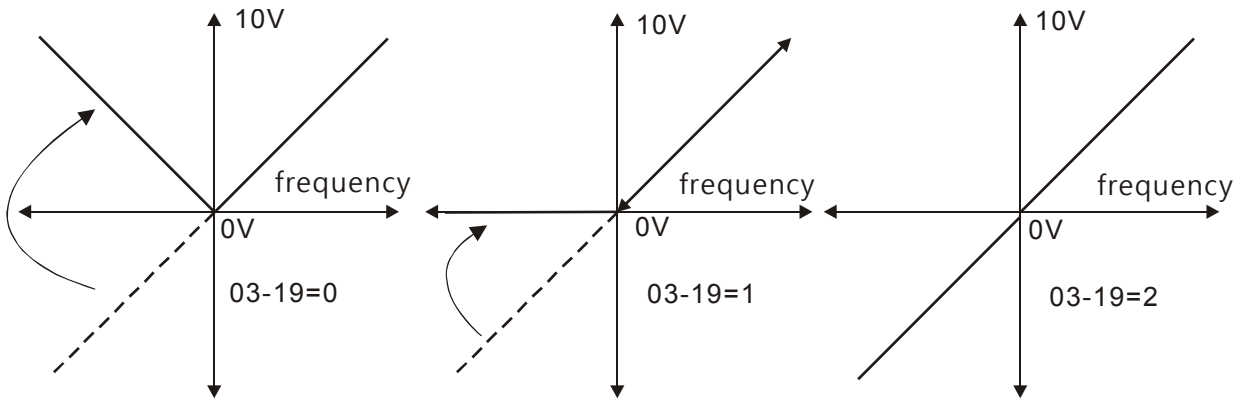

Selection for the analog output direction

03-23 Analog Input Type (AUI1)

03-24 Analog Input Type (AUI2)

Control Mode **VF VFBG SVC FOC PG TQCPG FOC PM** Factory Setting: 0

Settings 0: Bipolar ($\pm 10V$)

1: Unipolar (0~10V)

- When setting to 0 and Pr.03-00=1 or 2, AUI can decide the operation direction.
- When setting to 1 and Pr.03-00=1, the operation direction can be set by FWD/REV terminal.
- When setting to 1 and Pr.03-00=2, the operation direction can be set by setting 39 of Pr.02-01 to Pr.02-08.

04 Multi-Step Speed Parameters

- ↘ **04-00** Zero Step Speed Frequency
- ↘ **04-01** 1st Step Speed Frequency
- ↘ **04-02** 2nd Step Speed Frequency
- ↘ **04-03** 3rd Step Speed Frequency
- ↘ **04-04** 4th Step Speed Frequency
- ↘ **04-05** 5th Step Speed Frequency
- ↘ **04-06** 6th Step Speed Frequency
- ↘ **04-07** 7th Step Speed Frequency
- ↘ **04-08** 8th Step Speed Frequency
- ↘ **04-09** 9th Step Speed Frequency
- ↘ **04-10** 10th Step Speed Frequency
- ↘ **04-11** 11th Step Speed Frequency
- ↘ **04-12** 12th Step Speed Frequency
- ↘ **04-13** 13th Step Speed Frequency
- ↘ **04-14** 14th Step Speed Frequency

Control Mode **VF** **VFPG** **SVC** **FOCPG** **FOCPM** Factory Setting:0.00
 Settings 0.00~120.00Hz

- ↘ **04-15** 15th Step Speed Frequency

Control Mode **VF** **VFPG** **SVC** **FOCPG** **FOCPM** Factory Setting:0.00
 Settings 0.00~400.00Hz

 The Multi-Function Input Terminals (refer to Pr.02-01 to 02-08) are used to select one of the AC motor drive Multi-step speeds (including the main speed, in total 16 speeds). The speeds (frequencies) are determined by Pr.04-00 to 04-15 as shown above.

04-16 Direct docking mode only

~
04-99

Control Mode **VF** **VFPG** **SVC** **FOCPG** **FOCPM** Factory Setting:
 Settings Contact Delta for more information

05 IM Parameters

05-00 Motor Auto Tuning

Control Mode **VF**

Factory Setting: 0

- Settings
- 0: No function
 - 1: Rolling test (Rs, Rr, Lm, Lx, no-load current)
 - 2: Static Test

📖 Starting auto tuning by pressing RUN key and it will write the measure value into Pr.05-05 to Pr.05-09 (Rs, Rr, Lm, Lx, no-load current).

📖 The steps to AUTO-Tuning are: (when setting to 1)

1. Make sure that all the parameters are set to factory settings and the motor wiring is correct.
2. Make sure the motor has no-load before executing auto-tuning and the shaft is not connected to any belt or gear motor. It is recommended to set to 2 if the motor can't separate from the load.
3. Fill in Pr.01-02, Pr.01-01, Pr.05-01, Pr.05-02, Pr.05-03 and Pr.05-04 with correct values. Refer to motor capacity to set accel./decel. time.
4. When Pr.05-00 is set to 1, the AC motor drive will execute auto-tuning immediately after receiving a "RUN" command. (NOTE: the motor will run!)
5. After executing, please check if all values are filled in Pr.05-05 to Pr.05-09.
6. Equivalent circuit

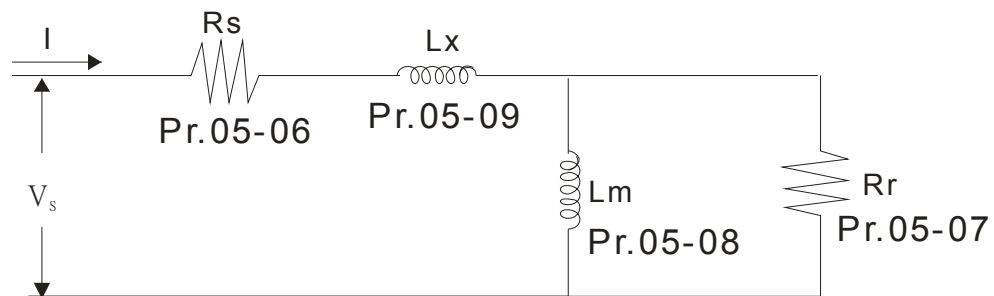

Equivalent circuit for VFD-ED Series

※ If Pr05-00 is set to <2: Static Test>, the input of Pr05-05 is required.

📖 NOTE

1. In torque/vector control mode, it is not recommended to have motors run in parallel.
2. It is not recommended to use torque/vector control mode if motor rated power exceeds the rated power of the AC motor drive.
3. The no-load current is usually 20~50% X rated current.
4. The rated speed can't be larger or equal to $120f/p$. (f: output frequency Pr.01-01, p: Number of Motor Poles Pr.05-04)
5. After the tuning, user needs to activate the drive again to make it operate if the source command of Auto-tuning comes from external terminal,

05-01 Full-load Current of MotorControl Mode **VF VFPG SVC FOC PG TQCPG**

Unit: Amp

Factory Setting:###

Settings (40~120%) *00-01 Amps

- This value should be set according to the rated frequency of the motor as indicated on the motor nameplate. The factory setting is 90% X rated current.
Example: if the rated current for 7.5hp (5.5kW) models is 25A and the factory setting is 22.5A. In this way, the current range will be from 10A (25*40%) to 30A (25*120%).
- As shown in the table below, the factory settings vary according to the different output in HP and in KW of motor drives.

	Motor drive's output (HP)	5	7.5	10	15	20	25	30	40	50	60	75	100
	Motor drive's output (KW)	4	5.5	7.5	11	15	18.5	22	30	37	45	55	75
230V	Full Load Current of Motor (A) Factory Setting	16.36	19.64	24.54	36.82	47.46	63	71.18	108	131.72			
460V	Full Load Current of Motor(A) Factory Setting	9.41	10.64	13.91	18.82	24.54	31.1	36.82	47.46	65.46			

05-02 Rated Power of MotorControl Mode **SVC FOC PG TQCPG**

Factory Setting: ###

Settings 0.00~655.35 kW

- It is used to set rated power of the motor. The factory setting is the power of the drive.

05-03 Rated Speed of Motor (rpm)Control Mode **VFPG SVC FOC PG TQCPG**

Factory Setting:1710

Settings 0~65535

- It is used to set the rated speed of the motor and need to set according to the value indicated on the motor nameplate.

05-04 Number of Motor PolesControl Mode **VF VFPG SVC FOC PG TQCPG**

Factory Setting:4

Settings 2~48

- It is used to set the number of motor poles (must be an even number).

05-05 No-load Current of MotorControl Mode **VFPG SVC FOC PG TQCPG**

Unit: Amp

Factory Setting:###

Settings 0~100%

- The factory setting is 40% X rated current.
- As shown in the table below, the factory settings vary according to the different output in HP and in KW of motor drives.

	Motor drive's output (HP)	5	7.5	10	15	20	25	30	40	50	60	75	100
	Motor drive's output (KW)	4	5.5	7.5	11	15	18.5	22	30	37	45	55	75
230V	Current of Motor w/o load (A) Factory Setting	5.73	6.85	8.5	12.56	15.97	20.78	23.22	33.51	39.52			
460V	Current of Motor w/o load (A) Factory Setting	3.29	3.71	4.81	6.43	8.26	10.28	11.99	15	19.64			

05-06 Rs of Motor

05-07 Rr of Motor

Control Mode **SVC FOC PG TQCPG** Factory Setting:0.000
Settings 0.000~65.535Ω

05-08 Lm of Motor

05-09 Lx of Motor

Control Mode **SVC FOC PG TQCPG** Factory Setting:0.0
Settings 0.0~6553.5mH

✎ **05-10** Torque Compensation Time Constant

Control Mode **SVC** Factory Setting:0.020
Settings 0.001~10.000sec

✎ **05-11** Slip Compensation Time Constant

Control Mode **SVC** Factory Setting:0.100
Settings 0.001~10.000sec

📖 Setting Pr.05-10 and Pr.05-11 change the response time for the compensation.

📖 When Pr.05-10 and Pr.05-11 are set to 10 seconds, its response time for the compensation will be the longest. But if the settings are too short, unstable system may occur.

✎ **05-12** Torque Compensation Gain

Control Mode **VF VFPG** Factory Setting: 0
Settings 0~10

📖 This parameter may be set so that the AC motor drive will increase its voltage output to obtain a higher torque.

✎ **05-13** Slip Compensation Gain

Control Mode **SVC** Factory Setting:0.00
Settings 0.00~10.00

📖 When the asynchronous motor is driven by the drive, the load and slip will be increased. This parameter can be used to correct frequency and lower the slip to make the motor can run near the synchronous speed under rated current. When the output current is larger than the motor no-load current, the drive will compensate the frequency by Pr.05-13 setting. If the actual speed is slower than expectation, please increase the setting and vice versa.

📖 It is only valid in SVC mode.

↗	05-14	Slip Deviation Level						
	Control Mode	VFPG	SVC	FOCPG				Factory Setting: 0
	Settings	0~1000%						
		0: Disable						

↗	05-15	Detection time of Slip Deviation						
	Control Mode	VFPG	SVC	FOCPG				Factory Setting:1.0
	Settings	0.0~10.0sec						

↗	05-16	Over Slip Treatment						
	Control Mode	VFPG	SVC	FOCPG				Factory Setting: 0
	Settings	0: Warn and keep operation						
		1: Fault and ramp to stop						
		2: Fault and coast to stop						

📖 Pr.05-14 to Pr.05-16 are used to set allowable slip level/time and over slip treatment when the drive is running.

↗	05-17	Hunting Gain						
	Control Mode	VF	VFPG	SVC				Factory Setting:2000
	Settings	0~10000						
		0: Disable						

📖 The motor will have current wave motion in some specific area. It can improve this situation by setting this parameter. (When it is high frequency or run with PG, Pr.05-17 can be set to 0. when the current wave motion happens in the low frequency, please increase Pr.05-17.)

	05-18	Accumulative Motor Operation Time (Min.)						
	Control Mode	VF	VFPG	SVC	FOCPG	TQCPG	FOCPM	Factory Setting:00
	Settings	00~1439 minutes						

	05-19	Accumulative Motor Operation Time (Day)						
	Control Mode	VF	VFPG	SVC	FOCPG	TQCPG	FOCPM	Factory Setting:00
	Settings	00~65535 days						

📖 Pr. 05-18 and Pr.05-19 are used to record the motor operation time. They can be cleared by setting to 00 and time which is less than 60 seconds will not be recorded.

↗	05-20	Core Loss Compensation						
	Control Mode	SVC						Factory Setting:10
	Settings	0~250%						

05-21 Accumulative Drive Power-on Time (Min.)

Control Mode **VF** **VFPG** **SVC** **FOCPG** **TQCPG** **FOCPM** Factory Setting:00
 Settings 00~1439 minutes

05-22 Accumulative Drive Power-on Time (day)



Control Mode **VF** **VFPG** **SVC** **FOCPG** **TQCPG** **FOCPM** Factory Setting:00
 Settings 00~65535 days

05-23 Slip compensation gain % (electricity generating mode)

Control Mode **VF** **SVC** Factory Setting: 0.0
 Settings 0.0~100.0%

05-24 Slip compensation gain % (electric mode)

Control Mode **VF** **SVC** Factory Setting: 0.0
 Settings 0.0~100.0%

-  When in VF mode, it is NOT required to set Pr05-13. To satisfy the end user's demand on different compensation gain of electricity generating mode and electric mode, simply set up Pr05-23 and Pr05-24.
-  When in SVC mode, it is required to set Pr05-13. Then to satisfy the end user's demand on different compensation gain of electricity generating mode and electric mode, simply set up Pr05-23 and Pr05-24.

06 Protection Parameters

06-00 Low Voltage Level

Control Mode **VF** **VFP** **SVC** **FOCP** **TQCP** **FOCP** Factory Setting:180.0/360.0
 Settings 230V series: 160.0~220.0V
 460V series: 320.0~440.0V

It is used to set the Lv level.

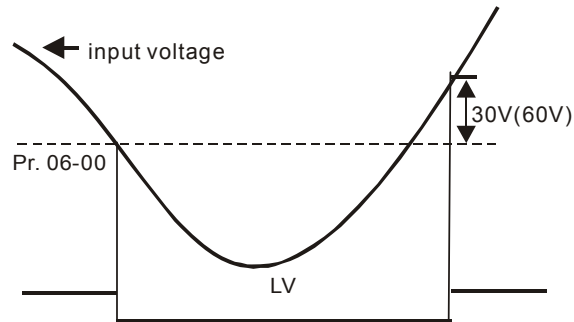

06-01 Phase-loss Protection

Control Mode **VF** **VFP** **SVC** **FOCP** **TQCP** **FOCP** Factory Setting:2
 Settings 0: Warn and keep operation
 1: Fault and ramp to stop
 2: Fault and coast to stop

It is used to set the phase-loss treatment. The phase-loss will effect driver's control characteristic and life

06-02 Over-Current Stall Prevention during Acceleration

Control Mode **VF** **VFP** **SVC** Factory Setting:00
 Settings 00: Disable
 00~250% (rated current of the motor drive)

During acceleration, the AC drive output current may increase abruptly and exceed the value specified by Pr.06-02 due to rapid acceleration or excessive load on the motor. When this function is enabled, the AC drive will stop accelerating and keep the output frequency constant until the current drops below the maximum value.

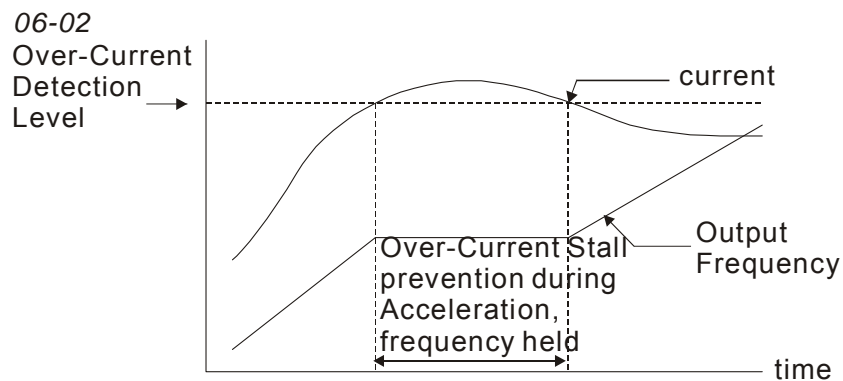

actual acceleration time when over-current stall prevention is enabled

06-03 Over-current Stall Prevention during Operation

Control Mode **VF** **VFPG** **SVC**

Factory Setting: 00

Settings 00: Disable

00~250% (rated current of the motor drive)

If the output current exceeds the setting specified in Pr.06-03 when the drive is operating, the drive will decrease its output frequency by Pr.06-04 setting to prevent the motor stall. If the output current is lower than the setting specified in Pr.06-03, the drive will accelerate (by Pr.06-04) again to catch up with the set frequency command value.

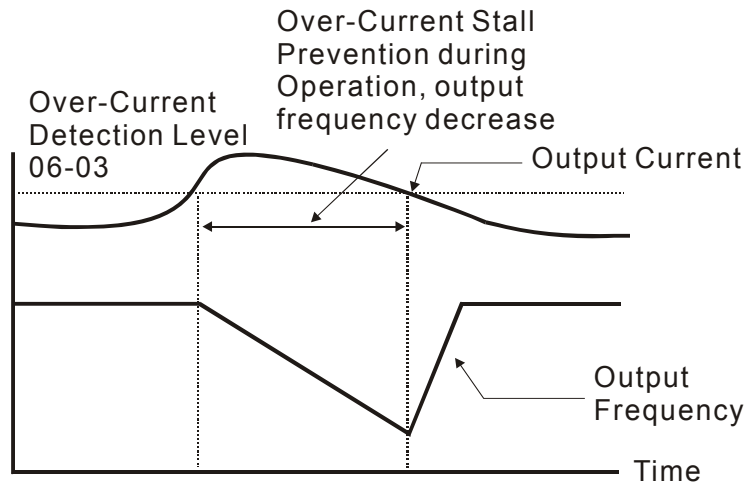

over-current stall prevention during operation

06-04 Accel. /Decel. Time Selection of Stall Prevention at constant speed

Control Mode **VF** **VFPG** **SVC**

Factory Setting: 0

Settings 0: current accel/decel time

1: the 1st accel/decel time

2: the 2nd accel/decel time

3: the 3rd accel/decel time

4: the 4th accel/decel time

5: auto accel/decel time

It is used to set the accel. /decel. time selection when stall prevention occurs at constant speed.

06-05 Over-torque Detection Selection (OT1)

Control Mode **VF** **VFPG** **SVC** **FOCPG** **TQCPG** **FOCPM**

Factory Setting: 0

Settings 0: Over-Torque detection disabled.

1: Over-torque detection during constant speed operation, continue to operate after detection

2: Over-torque detection during constant speed operation, stop operation after detection

3: Over-torque detection during operation, continue to operate after detection

4: Over-torque detection during operation, stop operation after detection

↘	06-06	Over-torque Detection Level (OT1)						
	Control Mode	VF	VFPG	SVC	FOCPG	TQCPG	FOCPM	Factory Setting:150
	Settings	10~250% (rated current of the motor drive)						
↘	06-07	Over-torque Detection Time (OT1)						
	Control Mode	VF	VFPG	SVC	FOCPG	TQCPG	FOCPM	Factory Setting:0.1
	Settings	0.1~60.0sec						
↘	06-08	Over-torque Detection Selection (OT2)						
	Control Mode	VF	VFPG	SVC	FOCPG	TQCPG	FOCPM	Factory Setting: 0
	Settings	0: Over-Torque detection disabled. 1: Over-torque detection during constant speed operation, continue to operate after detection 2: Over-torque detection during constant speed operation, stop operation after detection 3: Over-torque detection during operation, continue to operate after detection 4: Over-torque detection during operation, stop operation after detection						
↘	06-09	Over-torque Detection Level (OT2)						
	Control Mode	VF	VFPG	SVC	FOCPG	TQCPG	FOCPM	Factory Setting:150
	Settings	10~250% (rated current of the motor drive)						
↘	06-10	Over-torque Detection Time (OT2)						
	Control Mode	VF	VFPG	SVC	FOCPG	TQCPG	FOCPM	Factory Setting:0.1
	Settings	0.1~60.0sec						

Pr.06-05 and Pr.06-08 determine the operation mode of the drive after the over-torque is detected via the following method: if the output current exceeds the over-torque detection level (Pr.06-06) and also exceeds the Pr.06-07 Over-Torque Detection Time, the fault code “OT1/OT2” is displayed. If a Multi-Functional Output Terminal is to over-torque detection, the output is on. Please refer to Pr.02-11~02-22 for details.

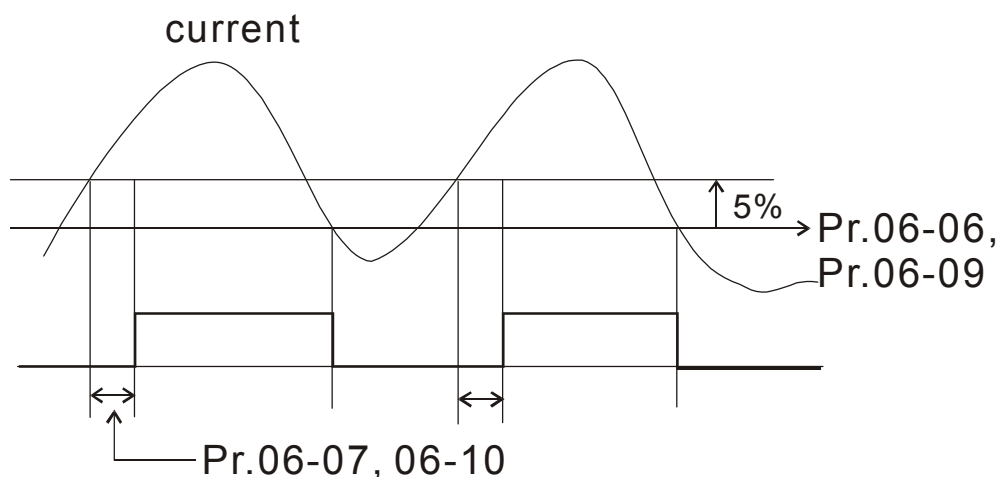

↘	06-11	Current Limit				
	Control Mode		FOCPG	TQCPG	FOCPM	Factory Setting:200
	Settings	0~250% (rated current of the motor drive)				

It is used to set the current limit.

06-12 Electronic Thermal Relay Selection

Control Mode **VF VFPG SVC FOC PG TQCPG FOC PM** Factory Setting:2

- Settings 0: Inverter motor
 1: Standard motor
 2: Disabled

It is used to prevent self-cooled motor overheats under low speed. User can use electrical thermal relay to limit driver's output power.

06-13 Electronic Thermal Characteristic

Control Mode **VF VFPG SVC FOC PG TQCPG FOC PM** Factory Setting:60.0

Settings 30.0~600.0sec

The parameter is set by the output frequency, current and operation time of the drive for activating the I²t electronic thermal protection function. The function will be activated for the 150% * setting current for the setting of Pr.06-13.

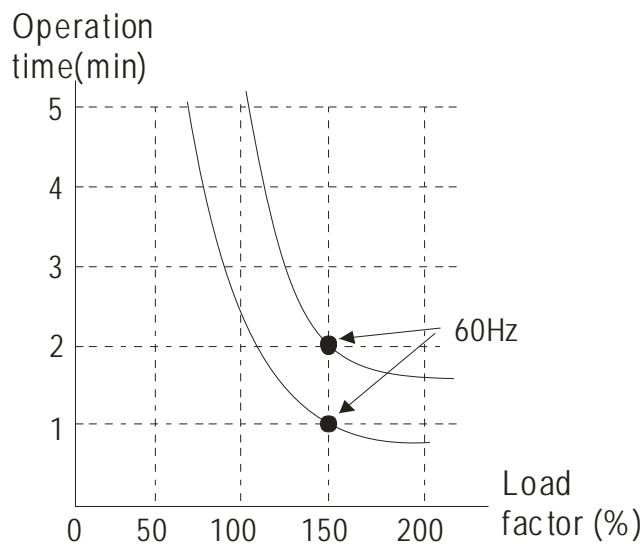

06-14 Heat Sink Over-heat (OH) Warning

Control Mode **VF VFPG SVC FOC PG TQCPG FOC PM** Factory Setting:90.0

Settings 0.0~110.0°C

06-15 Stall Prevention Limit Level

Control Mode **VF VFPG SVC** Factory Setting:50

Settings 0~100% (Refer to Pr06-02, Pr06-03)

When the operating frequency is larger than Pr.01-01, Pr06-02=150%, Pr. 06-03=100% and Pr. 06-15=80%:

Stall Prevention Level during acceleration = $06-02 \times 06-15 = 150 \times 80\% = 120\%$.

Stall Prevention Level at constant speed = $06-03 \times 06-15 = 100 \times 80\% = 80\%$.

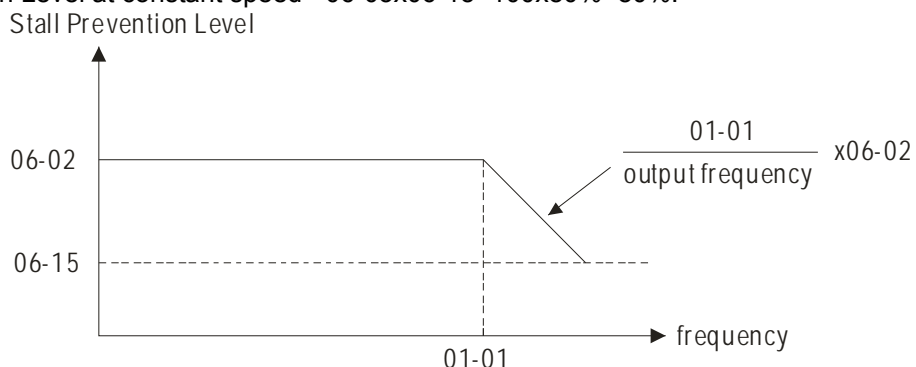

06-16	Present Fault Record
06-17	Second Most Recent Fault Record
06-18	Third Most Recent Fault Record
06-19	Fourth Recent Fault Record
06-20	Fifth Most Recent Fault Record
06-21	Sixth Most Recent Fault Record

Control mode	VF	VFPG	SVC	FOCPG	TQCPG	FOCPM	Factory setting:
	Readings	0	No fault				0
		1	Over-current during acceleration (ocA)				
		2	Over-current during deceleration (ocd)				
		3	Over-current during constant speed (ocn)				
		4	Ground fault (GFF)				
		5	IGBT short-circuit (occ)				
		6	Over-current at stop (ocS)				
		7	Over-voltage during acceleration (ovA)				
		8	Over-voltage during deceleration (ovd)				
		9	Over-voltage during constant speed (ovn)				
		10	Over-voltage at stop (ovS)				
		11	Low-voltage during acceleration (LvA)				
		12	Low-voltage during deceleration (Lvd)				
		13	Low-voltage during constant speed (Lvn)				
		14	Low-voltage at stop (LvS)				
		15	Input phase loss (PHL)				
		16	IGBT over-heat (oH1)				
		17	Bulk capacitor over-heat (oH2)				
		18	Abnormal IGBT temperature detected (tH1o)				
		19	Abnormal bulk capacitor temperature detected (tH2o)				
		20	Unusual cooling fan operation (FAn)				
		21	Over-load (oL) (150%; 1 minute, motor drive overloaded)				
		22	Motor over-loaded (EoL1)				
		23	Reserved				
		24	Motor PTC overheat (oH3)				
		25	Reserved				
		26	Over-torque 1 (ot1)				
		27	Over-torque 1 (ot2)				
		28	Reserved				
		29	Reserved				
		30	Memory write-in error (cF1)				
		31	Memory read-out error (cF2)				
		32	Isum current detection error (cd0)				
		33	U-phase current detection error (cd1)				
		34	V-phase current detection error (cd2)				
		35	W-phase current detection error (cd3)				
		36	cc current clamp hardware error (Hd0)				

37	oc (over-current) hardware error (Hd1)
38	ov (over-voltage) hardware error (Hd2)
39	GFF (ground fault) hardware error (Hd3)
40	Auto tuning error on motor's parameter (AuE)
41	Reserved
42	PG feedback error (PGF1)
43	PG feedback loss (PGF2)
44	PG feedback stall (PGF3)
45	PG slip error (PGF4)
46	Reserved
47	Reserved
48	Reserved
49	External fault input (EF)
50	Emergency stop by external terminals (EF1)
51	Reserved
52	Password error after three attempts (Pcod)
53	Reserved
54	Illegal communication command (cE01)
55	Illegal communication address (cE02)
56	Communication data length error (cE03)
57	Communication being written to a read-only address (cE04)
58	Modbus transmission time-out (cE10)
59	Keypad transmission time-out (cP10)
60	Brake chopper error (BF)
61-63	Reserved
64	Mechanical brake feedback error (MBF)
65	PGF5 hardware error
66	Magnetic contactor error (MCF)
67	Output phase loss (MPHL)
68	CAN Bus disconnected
69	Reserved
70	Reserved
71	Reserved
72	Safety torque loss (STL1)
73	PGcd hardware error
74	PG absolute signal error (PGHL)
75	PG Z phase signal loss (PGAF)
76	Safety torque output stops(STO)
77	Safety torque loss 2 (STL2)
78	Safety torque loss 3 (STL3)

 It will record when the fault occurs and force stopping. For the Lv, it will record when it is operation, or it will warn without record.

 The definition of codes #69~#71 have been modified in v1.04. See Ch14 for more information

06-30 Setting Method of Fault Output

Control Mode **VF VFPG SVC FOC PG TQCPG FOC PM**

Factory Setting: 0

Settings 0: By settings of Pr.06-22~06-25

1: By the binary setting

It is used with the settings 35~38 of Pr.02-11~02-22 (Multi-function Output). The fault output selection 1~4 corresponds to Bit 0~3.

This parameter provides two setting methods for the fault output. Setting 0: it is set by the settings of Pr.06-22~Pr.06-25. Setting 1: it is set by the binary setting. Refer to the following example for details.

Example:

Assume that

Pr.02-13 (Multi-function Output 3 R1A (Relay3)) is set to 35 Fault output option 1 (Pr.06-22).

Pr.02-14 (Multi-function Output 4 R2A (Relay4)) is set to 36 Fault output option 2 (Pr.06-23).

Pr.02-15 (Multi-function Output 5 (MO1)) is set to 37 Fault output option 3 (Pr.06-24).

Pr.02-16 (Multi-function Output 6 (MO2)) is set to 38 Fault output option 4 (Pr.06-25).

Assume that external faults output with the following signal: R1A=1, R2A=1, MO1=0 and MO2=1. The corresponding Bit 3~0 is 1011.

Bit 3	Bit 2	Bit 1	Bit 0	Fault code
-	-	-	-	0: No fault
0	0	0	1	1: Over-current during acceleration (ocA)
				2: Over-current during deceleration (ocd)
				3: Over-current during constant speed (ocn)
				4: Ground fault (GFF)
				5: IGBT short-circuit (occ)
				6: Over-current at stop (ocS)
0	0	1	0	7: Over-voltage during acceleration (ovA)
				8: Over-voltage during deceleration (ovd)
				9: Over-voltage during constant speed (ovn)
				10: Over-voltage at stop (ovS)
0	0	1	1	11: Low-voltage during acceleration (LvA)
				12: Low-voltage during deceleration (Lvd)
				13: Low-voltage during constant speed (Lvn)
				14: Low-voltage at stop (LvS)
				15: Input phase loss (PHL)
0	1	0	0	16: IGBT over-heat (oH1)
				17: Bulk capacitor over-heat (oH2)
				18: Abnormal IGBT temperature detected (tH1o)
				19: Abnormal bulk capacitor temperature detected (tH2o)
1	0	0	0	20: Unusual cooling fan operation (FAn)
0	1	0	1	21: Over-load (oL) (150% 1 minute, motor drive overloaded)
0	1	1	0	22: Motor over-load (EoL1)
				24: Motor PTC overheat (oH3)
0	1	1	1	26: Over-torque 1 (ot1)
				27: Over-torque 1 (ot2)
1	0	0	0	30: Memory write-in error (cF1)
				31: Memory read-out error (cF2)
				32: Isum current detection error (cd0)
				33: U-phase current detection error (cd1)
				34: V-phase current detection error (cd2)
				35: W-phase current detection error (cd3)
				36: cc (current clamp) hardware error (Hd0)
				37: oc (over-current) hardware error (Hd1)
				38: ov (over-voltage) hardware error (Hd2)
				39: GFF (ground fault) hardware error (Hd3)
1	0	0	1	40: Auto tuning error on motor's parameter (AUE)

Bit 3	Bit 2	Bit 1	Bit 0	Fault code
1	0	1	0	41: Reserved
				42: PG feedback error (PGF1)
				43: PG feedback loss (PGF2)
0	1	1	1	44: PG feedback stall (PGF3)
1	0	1	0	45: PG slip error (PGF4)
				46: Reserved
				47: Reserved
1	0	1	1	48: Reserved
1	0	1	1	49: External fault input (EF)
1	0	0	1	50: Emergency stop by external terminals(EF1)
1	0	0	1	52: Password error after three attempts (Pcod)
1	1	0	0	54: Illegal communication command (cE01)
				55: Illegal communication address (cE02)
				56: Communication data length error (cE03)
				57: Communication being written to a read-only address (cE04)
				58: Modbus transmission time-out (cE10)
1	0	0	0	59: Keypad transmission time-out (cP10)
1	0	0	0	60: Brake chopper error (BF)
1	0	1	1	63: Reserved
				64: Mechanical brake feedback error (MBF)
1	0	0	0	65: PGF5 hardware error
1	0	1	1	66: Magnetic contactor error (MCF)
1	0	1	1	67: Output phase loss (MPHL)
1	1	0	1	68: CAN Bus disconnected (CANF)
1	1	1	0	69: Reserved
1	1	1	0	70: Reserved
1	1	1	0	71: Reserved
1	1	1	0	72: Safety torque loss (STL1)

- ↗ **06-22** Fault Output Option 1
- ↗ **06-23** Fault Output Option 2
- ↗ **06-24** Fault Output Option 3
- ↗ **06-25** Fault Output Option 4

Control Mode **VF VFPG SVC FOC PG TQCPG FOC PM**

Factory Setting: 0

Settings 0~6553 sec (refer to bit table for fault code)

📖 These parameters can be used with multi-function output (set Pr.02-11 to Pr.02-22 to 35-38) for the specific requirement. When a fault occurs, the corresponding terminals will be activated (It needs to convert binary value to decimal value to fill in Pr.06-22 to Pr.06-25).

Fault code	Bit0	Bit1	Bit2	Bit3	Bit4	Bit5	Bit6
	current	Volt.	OL	SYS	FBK	EXI	CE
0: No fault							
1: Over-current during acceleration (ocA)	●						
2: Over-current during deceleration (ocd)	●						
3: Over-current during constant speed (ocn)	●						
4: Ground fault (GFF)						●	
5: IGBT short-circuit (occ)	●						
6: Over-current at stop (ocS)	●						
7: Over-voltage during acceleration (ovA)		●					
8: Over-voltage during deceleration (ovd)		●					
9: Over-voltage during constant speed (ovn)		●					
10: Over-voltage at stop (ovS)		●					
11: Low-voltage during acceleration (LvA)		●					
12: Low-voltage during deceleration (Lvd)		●					
13: Low-voltage during constant speed (Lvn)		●					
14: Low-voltage at stop (LvS)		●					
15: Input phase loss (PHL)						●	
16: IGBT over-heat (oH1)			●				
17: Bulk capacitor over-heat (oH2)			●				
18: Abnormal IGBT temperature detected (tH1o)			●				
19: Abnormal bulk capacitor temperature detected (tH2o)			●				
20: Unusual cooling fan operation (FAn)						●	
21: Over-load (oL) (150% 1 minute, motor drive overloaded)			●				
22: Motor over-load (EoL1)			●				
23: Reserved							
24: Motor PTC overheat (oH3)			●				
25: Reserved							

Fault code	Bit0	Bit1	Bit2	Bit3	Bit4	Bit5	Bit6
	current	Volt.	OL	SYS	FBK	EXI	CE
26: Over-torque 1 (ot1)			●				
27: Over-torque 1 (ot2)			●				
28: Reserved							
29: Reserved							
30: Memory write-in error (cF1)				●			
31: Memory read-out error (cF2)				●			
32: Isum current detection error (cd0)				●			
33: U-phase current detection error (cd1)				●			
34: V-phase current detection error (cd2)				●			
35: W-phase current detection error (cd3)				●			
36: cc (current clamp) hardware error (Hd0)				●			
37: oc (over-current) hardware error (Hd1)				●			
38: ov (over-voltage) hardware error (Hd2)				●			
39: GFF (ground fault) hardware error (Hd3)				●			
40: Auto tuning error on motor's parameter (AUE)				●			
41: Reserved					●		
42: PG feedback error (PGF1)					●		
43: PG feedback loss (PGF2)					●		
44: PG feedback stall (PGF3)					●		
45: PG slip error (PGF4)					●		
46: Reserved					●		
47: Reserved						●	
48: Reserved						●	
49: External fault input (EF)						●	
50: Emergency stop by external terminals(EF1)						●	
51: Reserved							
52: Password error after three attempts (Pcod)				●			
53: Reserved							
54: Illegal communication command (cE01)							●
55: Illegal communication address (cE02)							●
56: Communication data length error (cE03)							●
57: Communication being written to a read-only address (cE04)							●
58: Modbus transmission time-out (cE10)							●
59: Keypad transmission time-out (cP10)							●
60: Brake chopper error (BF)						●	
61-62: Reserved							
63: Reserved				●			

Fault code	Bit0	Bit1	Bit2	Bit3	Bit4	Bit5	Bit6
	current	Volt.	OL	SYS	FBK	EXI	CE
64: Mechanical brake feedback error (MBF)						●	
65: PGF5 hardware error				●			
66: Magnetic contactor error (MCF)						●	
67: Output phase loss (MPHL)						●	
68: CAN Bus disconnected (CANF)							●
69: Reserved				●			
70: Reserved				●			
71: Reserved				●			
72: Safety torque loss (STL1)				●			

06-26 PTC (Positive Temperature Coefficient) Detection Selection

Control Mode **VF VFPG SVC FOC PG TQCPG FOC PM** Factory Setting: 0
 Settings 0: Warn and keep operating
 1: Fault and ramp to stop

This parameter is to set the treatment after detecting PTC.

06-27 PTC Level

Control Mode **VF VFPG SVC FOC PG TQCPG FOC PM** Factory Setting: 50.0
 Settings 0.0~100.0%

This parameter is to set the PTC level. The corresponding value of 100% PTC level is the max. analog input value.

06-28 PTC Filter Time for PTC Detection

Control Mode **VF VFPG SVC FOC PG TQCPG FOC PM** Factory Setting: 0.20
 Settings 0.00~10.00sec

06-29 Voltage of Emergency Power

Control Mode **VF VFPG SVC FOC PG TQCPG FOC PM** Factory Setting: 24.0/48.0
 Settings 24.0~375.0Vdc
 48.0~750.0Vdc

This parameter needs to work with setting #43 <EPS function> of Pr02-01 ~ Pr02-08 <Multi-function input command>.

06-31 Phase Loss Detection of Drive Output at Start-Up(MPHL)

Control Mode **VF VFPG SVC FOC PG TQCPG FOC PM** Factory Setting: 0
 Settings 0: Disable
 1: Enable

When it is set to 1, it will auto detect if the connection between the drive and motor is normal whenever the drive runs. If errors occur to the connection between the drive and the motor, the drive will display fault code "67" to indicate motor output phase loss.

06-32 Accumulative Drive Power-on Time at the First Fault (min.)

06-34 Accumulative Drive Power-on Time at the Second Fault (min.)

06-36 Accumulative Drive Power-on Time at the Third Fault (min.)

06-38 Accumulative Drive Power-on Time at the Fourth Fault (min.)

06-40 Accumulative Drive Power-on Time at the Fifth Fault (min.)

06-42 Accumulative Drive Power-on Time at the Sixth Fault (min.)

Control Mode **VF VFPG SVC FOC PG TQCPG** Factory Setting: 00
 Settings 00~1439 min

06-33	Accumulative Drive Power-on Time at the First Fault (day)
06-35	Accumulative Drive Power-on Time at the Second Fault (day)
06-37	Accumulative Drive Power-on Time at the Third Fault (day)
06-39	Accumulative Drive Power-on Time at the Fourth Fault (day)
06-41	Accumulative Drive Power-on Time at the Fifth Fault (day)
06-43	Accumulative Drive Power-on Time at the Sixth Fault (day)

Control Mode **VF VFPG SVC FOC PG TQCPG** Factory Setting:00
 Settings 00~65535 day

↗ **06-44** Operation Speed of Emergency Power (EPS) Mode

Control Mode **VF VFPG SVC FOC PG TQCPG FOC PM** Factory Setting: Read Only
 Settings 0.00~400.00Hz

↗ **06-45** Fault and Warning handling methods

Control Mode **VF VFPG SVC FOC PG TQCPG FOC PM** Factory Setting: 0002h
 Settings Bit0 = 0: Display Lv fault and coast to stop
 Nit0 = 1: Display Lv warn and coast to stop
 Bit1= 0 : Fan lock, fault and coast to stop
 Bit1 = 1: Fan lock, warn and coast to stop
 Bit2 = 0: software GFF protection enabled
 Bit2 = 1: software GFF protection disabled

↗ **06-46** Operation Direction for Emergency Power (EPS) ON

Control Mode **VF VFPG SVC FOC PG TQCPG FOC PM** Factory Setting: 0
 Settings 0 Operate by current command
 1 Operate by the direction of power generating mode
 2 After determining the direction of power generating, the host computer sends the operating direction command. (When at STOP mode determine the direction of power generating mode (MO =32) but do not retain the direction of the power generating.)
 3 After determining the direction of power generating, the host computer send the operating direction command. (When at STOP mode, determine the direction of power generating mode (MO =32) and retain the direction of the power generating.)

📖 Pr.06-46 is enabled when the external terminal is detecting for the emergency power (EPS).

📖 When Pr.06-46 is set to 1 and a forward/reverse run command is given, the drive will begin to detect for the elevator loading and operates in the power regeneration direction (the motor is in power generating status). The drive will use and operate in the direction that was detected as its power regeneration direction. The drive will not operate in user command direction for safety purpose, to prevent voltage drop of emergency power (EPS).

VF and SVC control mode: within the time setting of Pr.06-47, the drive detects the elevator loading status by performing forward/reverse run. Then the elevator operates in power regeneration direction (the motor id in power generating status). Refer to the diagram below for the Auto-Detection Time Graph.

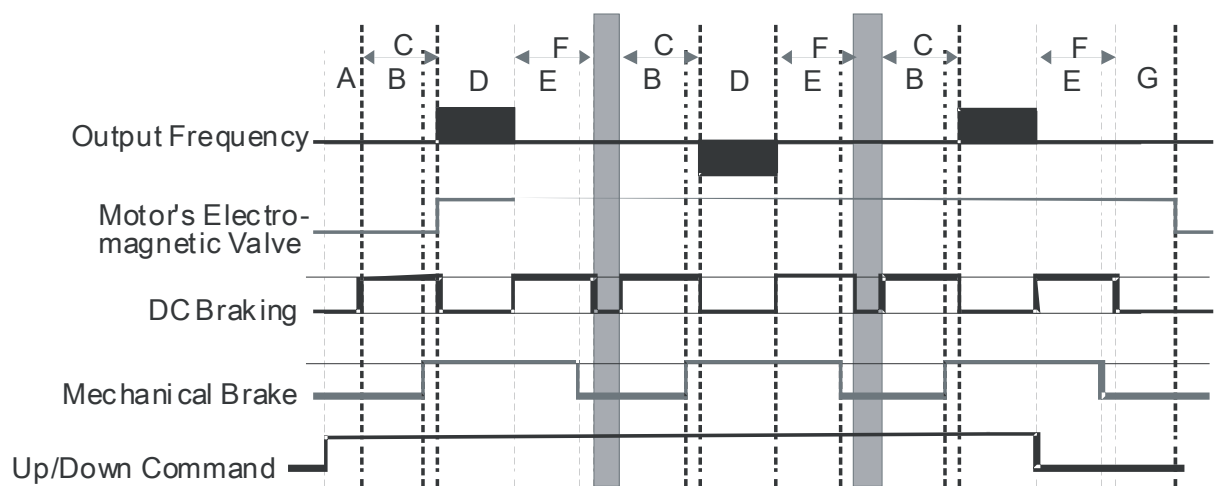
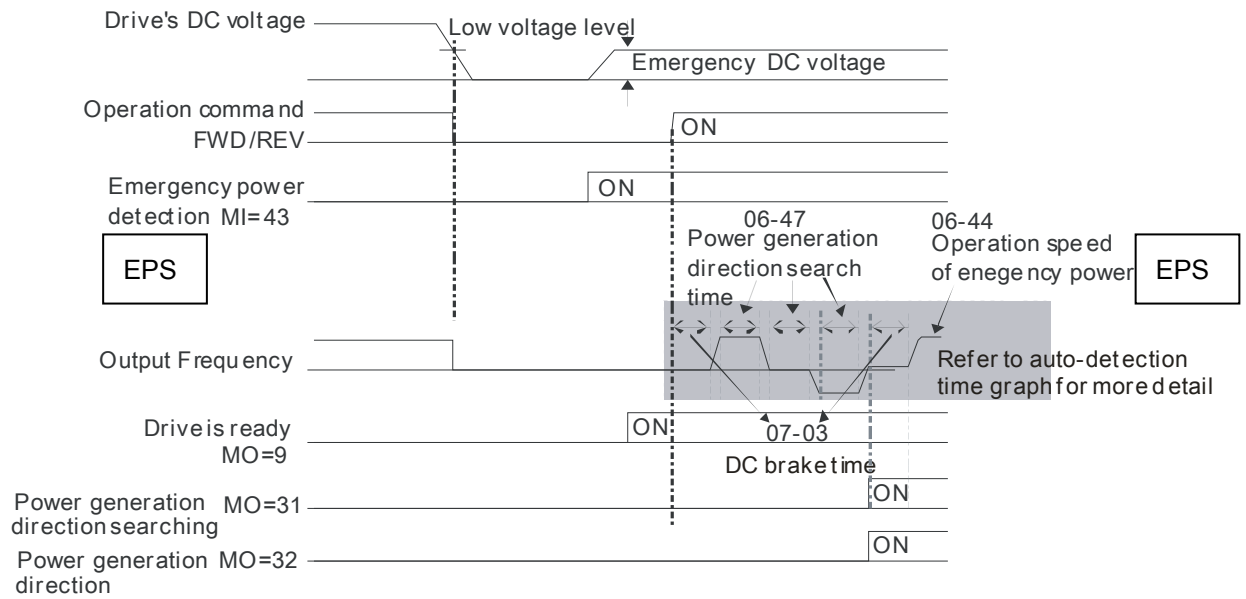

- | | |
|--|---|
| A 02-31: Turn On Delay of Magnetic Contactor between Drive and Motor | E 02-30: Brake Engage Delay Time when Elevator Stops |
| B 02-29: Brake Release Delay Time when Elevator Starts | F 07-04: Require DC Brake Time to Stop |
| C 07-03: DC Brake Activation Time | G 02-32: Turn Off Delay of Magnetic Contactor between Drive and Motor |
| D 06-47: Power Generation Direction Searching Time | |

Auto-detection Time Graph

FOCPG/PM Control Mode: within the time setting of Pr.06-47, the drive maintains at zero-speed and it is able to determine the elevator loading without performing forward/reverse run. Then the elevator operates in power regeneration direction (the motor is in power generating status). Refer to the diagram below for the Auto-Detection Time Graph.

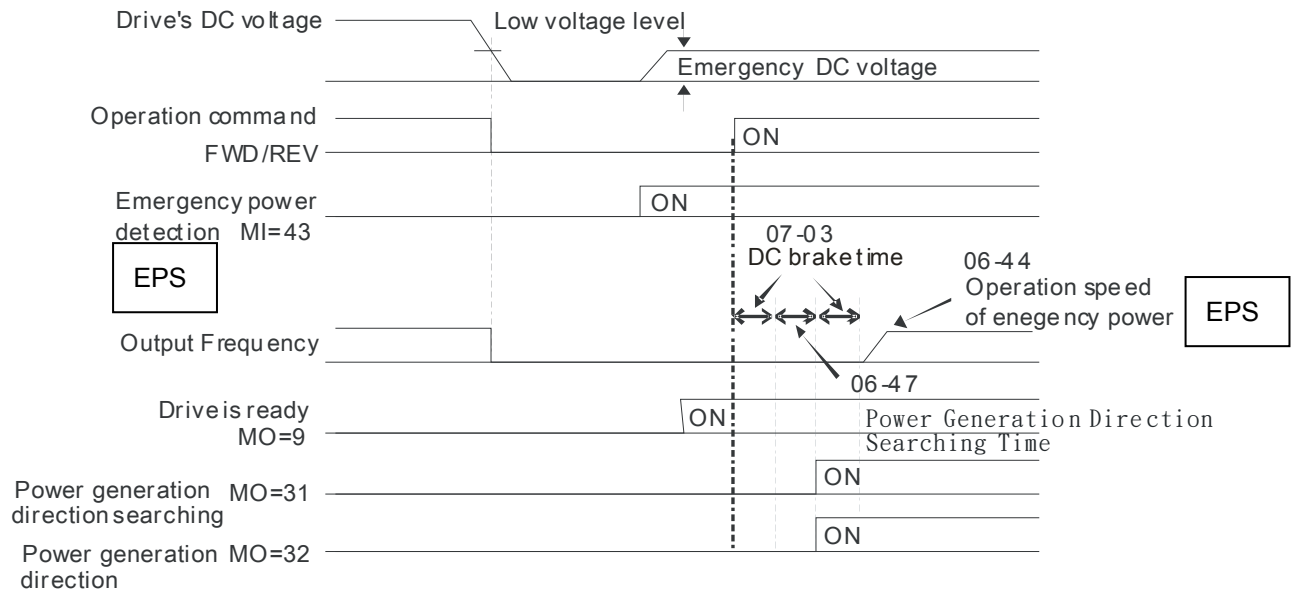

⚡ **06-47** Power Generation Direction Searching Time
 Control Mode **VF VFPG SVC FOC PG TQCPG FOC PM** Factory Setting:1.0
 Settings 0.0 ~ 5.0sec

06-48 Power Capacity of Emergency Power (EPS)
 Control Mode **VF VFPG SVC FOC PG TQCPG FOC PM** Factory Setting:0.0
 Settings 0.0 ~ 100.0 kVA

📖 When using emergency power (EPS), user must input the required power capacity for the emergency power and then the AC drive will calculate the acceptable elevator speed (Pr.06-44) by following equation.



$$V_{eps_max} = \frac{06-48 \times 0.5}{\sqrt{3} \times I_{motor_rated}}$$

$$f_{eps_limit} = \frac{V_{eps_max}}{01-02} \times 01-01 \times 0.5$$

$$I_{motor_rated} = 05-01 \text{ (Induction Motor)} / 08-01 \text{ (PM Motor)}$$

- 📖 When Frequency Command f_{EPS} , the operation speed of emergency power (EPS) is f_{EPS} .
- 📖 When Frequency Command $\leq f_{EPS}$, the operation speed of emergency power (EPS) is set by current frequency command.

06-49 STO Latch Selection
 Control Mode **VF VFPG SVC FOC PG TQCPG FOC PM** Factory Setting: 0
 Settings 0: STO alarm Latch
 1: STO alarm no Latch
 2: STO Latch (Warn and record running commands when stop)
 3: STO No Latch (Warn and record running commands when stop)

📖 When Pr06-49=0, STO alarm is latched which means once the cause of the alarm is cleared, a Reset command is required to clear the STO alarm.

📖 When Pr06-49=1, STO alarm is NOT latched which means once the cause of the alarm is cleared, the STO alarm will stop automatically.

📖 When in STL1~STL3 mode, STO alarm is latched and Pr06-49 cannot be set.

06-50 Selection of MO's action when retrying after fault

Control Mode VF VFPG SVC FOC PG TQCPG FOC PM Factory Setting: 0
 Settings 0: Output
 1: NO output

 To determine if to display fault indication when the following faults have occurred:

- 7: Over-voltage during acceleration (ovA)
- 8: Over-voltage during deceleration (ovd)
- 9: Over-voltage during constant speed (ovn)
- 10: Over-voltage at stop (ovS)
- 11: Low-voltage during acceleration (LvA)
- 12: Low-voltage during deceleration (Lvd)
- 13: Low-voltage during constant speed (Lvn)
- 14: Low-voltage at stop (LvS)
- 15: Input Phase loss (PHL)

 Two MO terminals are affected by this parameters and should be set up as

MO= 10: Low voltage warning (LV)

MO= 11: Fault Indication

06-51 Number of times of retrying after fault

Control Mode VF VFPG SVC FOC PG TQCPG FOC PM Factory Setting: 0
 Settings 0~10 times

 To determine number of times to retry when the following faults have occurred:

- 7: Over-voltage during acceleration (ovA)
- 8: Over-voltage during deceleration (ovd)
- 9: Over-voltage during constant speed (ovn)
- 10: Over-voltage at stop (ovS)
- 11: Low-voltage during acceleration (LvA)
- 12: Low-voltage during deceleration (Lvd)
- 13: Low-voltage during constant speed (Lvn)
- 14: Low-voltage at stop (LvS)
- 15: Input Phase loss (PHL)

 After every reattempt, the available number of times to retry will automatically be deducted as displayed on the keypad

 About number of time to reset

1. Reset the fault manually
2. After running normally for 10 minutes, the motor drive will be back to the prior setting.
3. The motor drive will be powered-down and powered-up again.

06-52 Time interval between retrying

Control Mode VF VFPG SVC FOC PG TQCPG FOC PM Factory Setting: 0
 Settings 0.5~600.0 sec.

 To determine time interval between retrying when the following faults have occurred:

- 7: Over-voltage during acceleration (ovA)
- 8: Over-voltage during deceleration (ovd)
- 9: Over-voltage during constant speed (ovn)
- 10: Over-voltage at stop (ovS)
- 11: Low-voltage during acceleration (LvA)
- 12: Low-voltage during deceleration (Lvd)
- 13: Low-voltage during constant speed (Lvn)
- 14: Low-voltage at stop (LvS)
- 15: Input Phase loss (PHL)

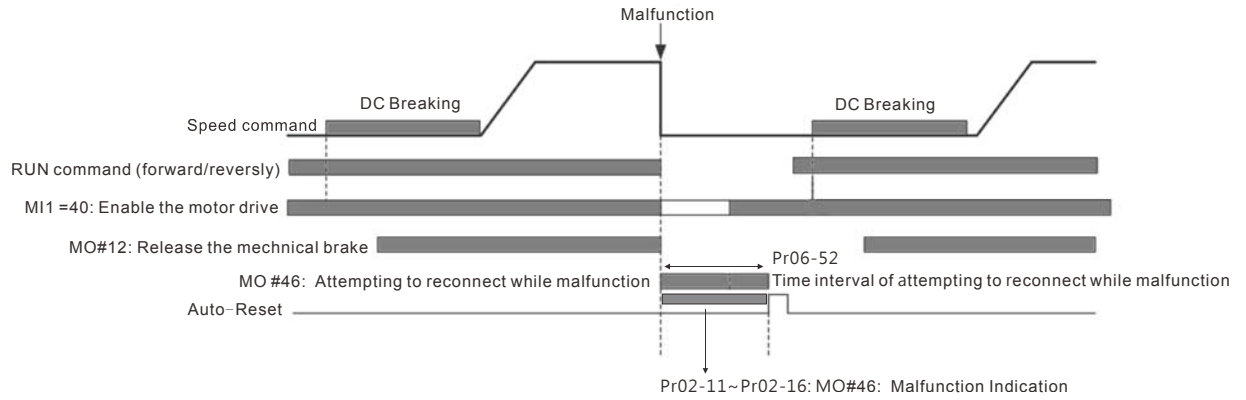

- ↘ **06-53** Frequency command when the most recent fault has occurred

Control Mode	VF	VFPG	SVC	FOCPG	TQCPG	FOCPM	Factory Setting: 0.00
Settings	0.00~655.35Hz						

- ↘ **06-54** Output frequency when the most recent fault has occurred

Control Mode	VF	VFPG	SVC	FOCPG	TQCPG	FOCPM	Factory Setting: 0.00
Settings	0.00~655.35Hz						

- ↘ **06-55** Output current when the most recent fault has occurred

Control Mode	VF	VFPG	SVC	FOCPG	TQCPG	FOCPM	Factory Setting : 0.00
Settings	0.00~655.35Amps						

- ↘ **06-56** Output current when the most recent fault has occurred

Control Mode	VF	VFPG	SVC	FOCPG	TQCPG	FOCPM	Factory Setting : 0.00
Settings	0.00~655.35Hz						

- ↘ **06-57** Output voltage when the most recent fault has occurred

Control Mode	VF	VFPG	SVC	FOCPG	TQCPG	FOCPM	Factory Setting: 0.0
Settings	0.00~6553.5V						

- ↘ **06-58** DC bus voltage when the most recent fault has occurred

Control Mode	VF	VFPG	SVC	FOCPG	TQCPG	FOCPM	Factory Setting : 0.0
Settings	0.00~6553.5V						

- ↘ **06-59** Output power when the most recent fault has occurred

Control Mode	VF	VFPG	SVC	FOCPG	TQCPG	FOCPM	Factory Setting : 0.0
Settings	0.00~6553.5kW						

- ↘ **06-60** Output torque when the most recent fault has occurred

Control Mode	VF	VFPG	SVC	FOCPG	TQCPG	FOCPM	Factory Setting:0.00
Settings	0.00~655.35%						

↗	06-61	IGBT's temperature when the most recent fault has occurred
Control Mode	VF VFPG SVC FOC PG TQCPG FOC PM	Factory Setting: 0.0
Settings	-3276.8~3276.7°C	
↗	06-62	Multi-input terminals' status when the most recent fault has occurred
Control Mode	VF VFPG SVC FOC PG TQCPG FOC PM	Factory Setting: 0000h
Settings	0000h~FFFFh	
↗	06-63	Multi-output terminals' status when the most recent fault has occurred
Control Mode	VF VFPG SVC FOC PG TQCPG FOC PM	Factory Setting: 0000h
Settings	0000h~FFFFh	
↗	06-64	Motor drive's status when the most recent fault has occurred
Control Mode	VF VFPG SVC FOC PG TQCPG FOC PM	Factory Setting: 0000h
Settings	0000h~FFFFh	

07 Special Parameters

07-00 Brake Chopper Level

Control Mode **VF VFPG SVC FOC PG TQCPG FOC PM** Factory Setting: 380.0/760.0
 Settings 230V series: 350.0~450.0Vdc
 460V series: 700.0~900.0Vdc

This parameter sets the DC-bus voltage at which the brake chopper is activated.

07-01 Reserved

07-02 DC Brake Current Level

Control Mode **VF VFPG SVC** Factory Setting: 0
 Settings 0~100% (rated current of the motor drive)

This parameter sets the level of DC Brake Current output to the motor during start-up and stopping. When setting DC Brake Current, the Rated Current (Pr.00-01) is regarded as 100%. It is recommended to start with a low DC Brake Current Level and then increase until proper holding torque has been attained.

When it is in FOC PG/TQCPG/FOCPM mode, it can enable DC brake function by setting to any value.

07-03 DC Brake Activation Time

Control Mode **VF VFPG SVC FOC PG FOC PM** Factory Setting: 0.7
 Settings 0.0~60.0sec

This parameter sets the duration of DC Brake current is supplied to motor when activating the drive.

07-04 DC Brake Stopping Time

Control Mode **VF VFPG SVC FOC PG FOC PM** Factory Setting: 0.7
 Settings 0.0~60.0sec

This parameter sets the duration of DC Brake current is supplied to motor when stopping the drive.

07-05 Start-Point for DC Brake

Control Mode **VF VFPG SVC FOC PG** Factory Setting: 0.00
 Settings 0.00~400.00Hz

This parameter determines the frequency when DC Brake will begin during deceleration. When the setting is less than start frequency (Pr.01-09), start-point for DC brake will begin from the min. frequency.

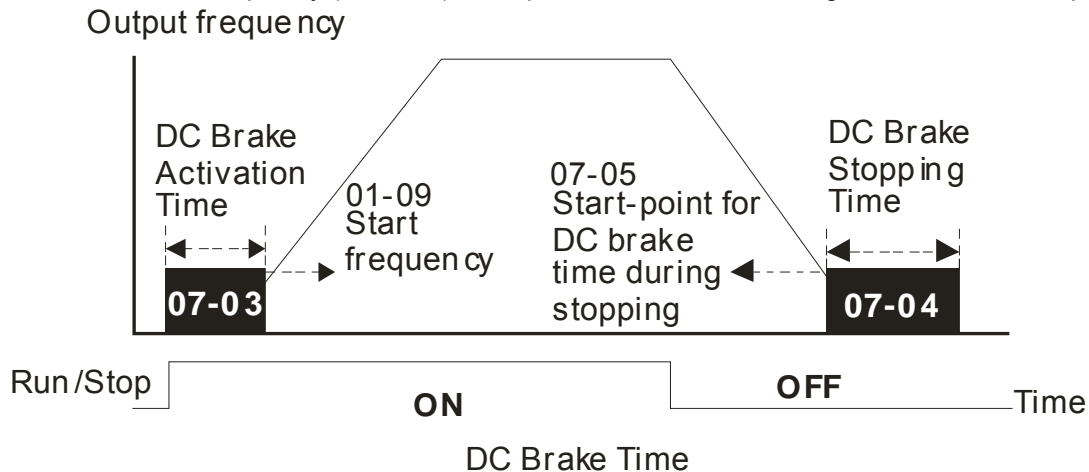

↗ **07-06** DC Brake Proportional Gain
 Control Mode **VF VFPG SVC** Factory Setting:50
 Settings 1~500

📖 It is used to set the output voltage gain when DC brakes.

↗ **07-07** Dwell Time at Accel.
 Control Mode **VF VFPG SVC FOC PG FOC PM** Factory Setting:0.00
 Settings 0.00~600.00sec

↗ **07-09** Dwell Time at Decel.
 Control Mode **VF VFPG SVC FOC PG FOC PM** Factory Setting:0.00
 Settings 0.00~600.00sec

↗ **07-08** Dwell Frequency at Accel.
 Control Mode **VF VFPG SVC FOC PG FOC PM** Factory Setting:0.00
 Settings 0.00~400.00Hz

↗ **07-10** Dwell Frequency at Decel.
 Control Mode **VF VFPG SVC FOC PG FOC PM** Factory Setting:0.00
 Settings 0.00~400.00 Hz

📖 In the heavy load situation, Dwell can make stable output frequency temporarily.

📖 Pr.07-07 to Pr.07-10 are for heavy load to prevent OV or OC occurs.

Frequency

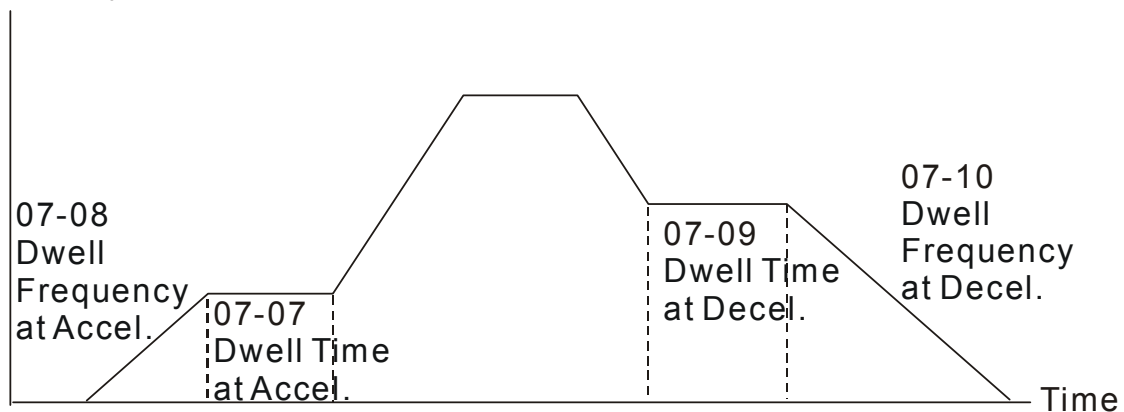

Dwell at accel./decel.

↗ **07-11** Cooling Fan Control
 Control Mode **VF VFPG SVC FOC PG TQCPG FOC PM** Factory Setting:2
 Settings 0: Fan always ON

- 1: 1 minute after AC motor drive stops, cooling fan will be OFF
- 2: AC motor drive runs and fan ON, AC motor drive stops and cooling fan OFF
- 3: Cooling fan ON to run when preliminary heat sink temperature attained
- 4: Cooling fan always OFF

📖 This parameter is used for the fan control.

📖 When setting to 3, fan will start to run until temperature is less than 40°C if temperature exceeds 40°C.

➤ **07-12** Torque Command

Control Mode **TQCPG** Factory Setting:0.0
 Settings -150.0 to 150.0% (Pr. 07-14 setting=100%)

📖 This parameter is torque command. When Pr.07-14 is 250% and Pr.07-12 is 100%, the actual torque command = 250X100% X motor rated torque.

➤ **07-13** Source of Torque Command

Control Mode **TQCPG** Factory Setting:2
 Settings 0: KPC-CC01 Digital keypad
 1: RS485 serial communication
 2: Analog signal (Pr.03-00)

📖 This parameter is torque command source and the torque command is in Pr.07-12

➤ **07-14** Maximum Torque Command

Control Mode **VF VFBG SVC FOC PG TQCPG FOC PM** Factory Setting:100
 Settings 0~300% (rated torque of the motor drive)

📖 This parameter is for the max. torque command (motor rated torque is 100%).

➤ **07-15** Filter Time of Torque Command

Control Mode **TQCPG** Factory Setting:0.000
 Settings 0.000~1.000sec

📖 When the setting is too long, the control will be stable but the control response will be delay. When the setting is too short, the response will be quickly but the control maybe unstable. User can adjust the setting by the control and response situation.

07-16 Speed Limit Selection

Control Mode **TQCPG** Factory Setting: 0
 Settings 0: By Pr.07-17 and Pr.07-18
 1: Frequency command source (Pr.00-14)

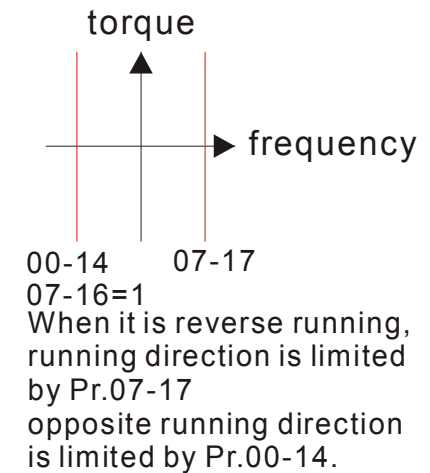
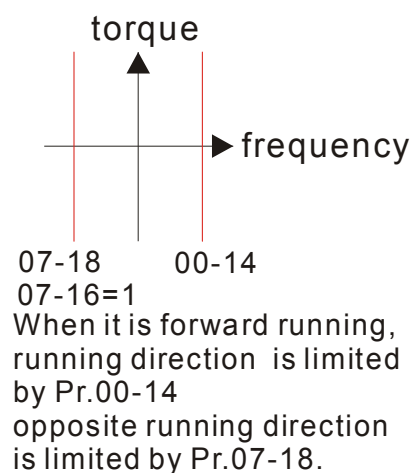
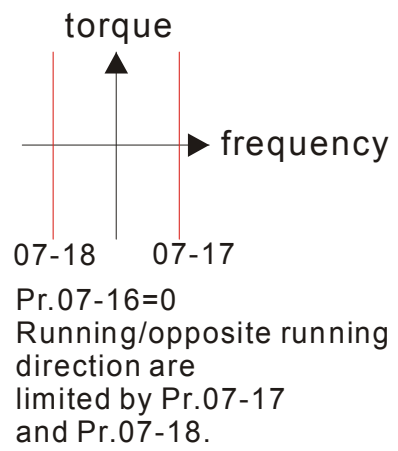

07-17 Torque Mode + Speed Limit

Control Mode **TQCPG** Factory Setting:10
 Settings 0~120%

07-18 Torque Mode - Speed Limit

Control Mode **TQCPG** Factory Setting:10
 Settings 0~120%

These parameters are used in the torque mode to limit the running direction and opposite direction.
 (Pr.01-00 max. output frequency=100%)

07-19 Source of Torque Offset

Control Mode **SVC FOC PG TQCPG FOC PM** Factory Setting: 0
 Settings 0: Disable
 1: Analog input (Pr.03-00)
 2: Torque offset setting (Pr.07-20)
 3: Control by external terminal (by Pr.07-21 to Pr.07-23)

This parameter is the source of torque offset.

When it is set to 3, the source of torque offset will decide to Pr.07-21, Pr.07-22 and Pr.07-23 by the multi-function input terminals setting (31, 32 or 33).

02-01~02-08 is set to31	02-01~02-08 is set to32	02-01~02-08 is set to 33	Torque offset
OFF	OFF	OFF	N/A
OFF	OFF	ON	07-23
OFF	ON	OFF	07-22
OFF	ON	ON	07-23+07-22
ON	OFF	OFF	07-21
ON	OFF	ON	07-21+07-23
ON	ON	OFF	07-21+07-22
ON	ON	ON	07-21+07-22+07-23

07-20 Torque Offset Setting

Control Mode **SVC FOC PG TQCPG FOC PM** Factory Setting:0.0
 Settings 0.0~100.0% (rated torque of the motor drive)

This parameter is torque offset. The motor rated torque is 100%.

07-21 High Torque Offset

Control Mode **SVC FOC PG TQCPG FOC PM** Factory Setting:30.0
 Settings 0.0~100.0% (rated torque of the motor drive)

07-22 Middle Torque Offset

Control Mode **SVC FOC PG TQCPG FOC PM** Factory Setting:20.0
 Settings 0.0~100.0% (rated torque of the motor drive)

07-23 Low Torque Offset

Control Mode **SVC FOC PG TQCPG FOC PM** Factory Setting:10.0
 Settings 0.0~100.0% (rated torque of the motor drive)

When it is set to 3, the source of torque offset will decide to Pr.07-21, Pr.07-22 and Pr.07-23 by the multi-function input terminals setting (19, 20 or 21). The motor rated torque is 100%.

- ↘ **07-24** Forward Motor Torque Limit
- ↘ **07-25** Forward Regenerative Torque Limit
- ↘ **07-26** Reverse Motor Torque Limit
- ↘ **07-27** Reverse Regenerative Torque Limit

Control Mode

FOCPG TQCPG FOCPM

Factory Setting:200

Settings 0~300% (rated torque of the motor drive)

- 📖 The motor rated torque is 100%. The settings for Pr.07-24 to Pr.07-27 will compare with Pr.03-00=5, 6, 7, 8. The minimum of the comparison result will be torque limit.
- 📖 The motor rated torque is 100%. The settings for Pr.07-24 to Pr.07-27 will compare with Pr.03-00=5, 6, 7, 8. The minimum of the comparison result will be torque limit.

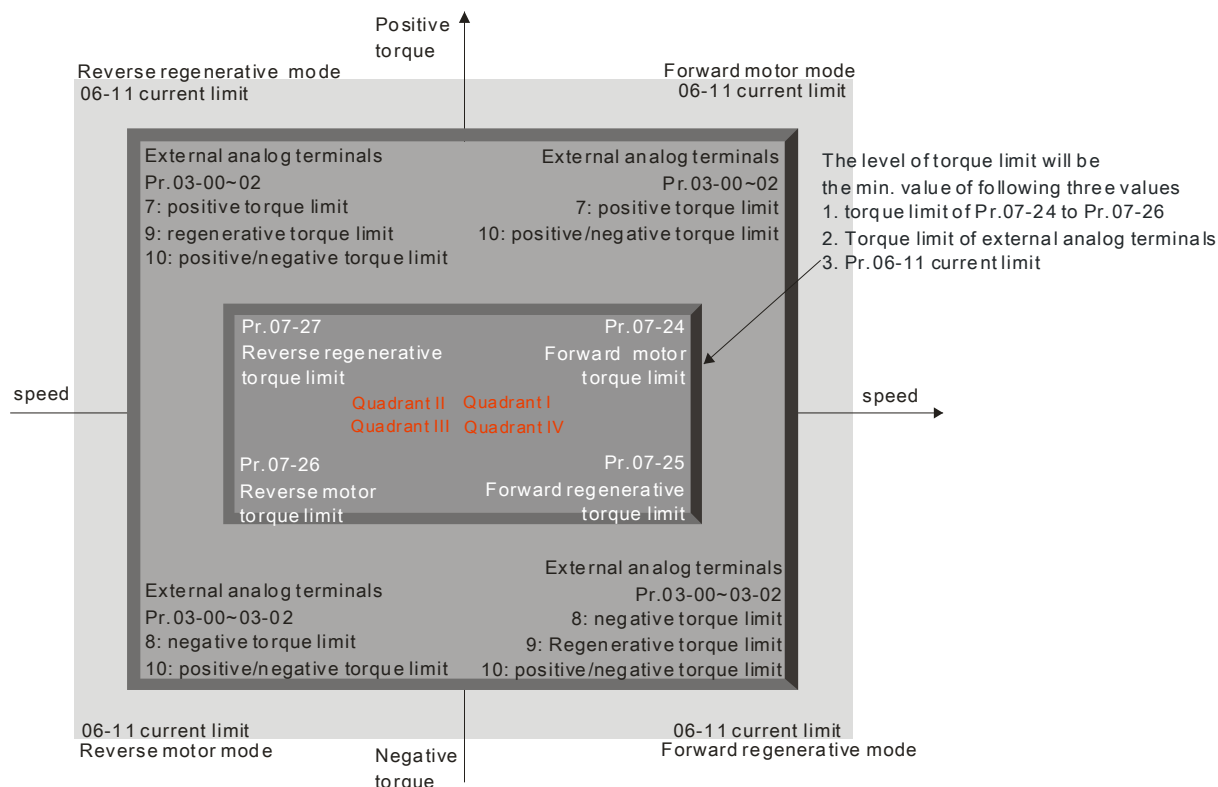

↘ **07-28** Emergency Stop (EF) & Forced Stop Selection

Control Mode

VF VFPG SVC FOCPG TQCPG FOCPM

Factory Setting: 0

- Settings 0: Coast to stop
- 1 : By deceleration Time 1
 - 2 : By deceleration Time 2
 - 3 : By deceleration Time 3
 - 4 : By deceleration Time 4
 - 5 : By Pr.01-31

- 📖 When the multi-function input terminal is set to 10 or 14 and it is ON, the AC motor drive will be operated by Pr.07-28.

↘ **07-29** Time for Decreasing Torque at Stop

Control Mode

FOCPG TQCPG FOCPM

Factory Setting:0.000

Settings 0.000~1.000sec

- 📖 When the elevator is stop and the mechanical brake is engaged, the drive will stop output. At the same time, it will produce the noise from the reacting force between the motor and the mechanical brake. This parameter can be used to decrease this reacting force and lower the noise.
- 📖 It is used to set the time for decreasing torque to 0%.

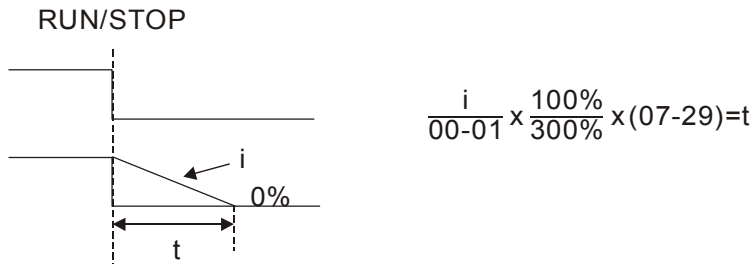

↖ **07-30** DC Braking Current Level

Control Mode **VF** **VFP** **SVC**

Factory Setting: 0

Settings; 0~100% (rated current of the motor drive)

- 📖 This parameter determines the amount of DC Braking Current applied to the motor during starting and stopping. When setting the DC Braking Current, note that 100% corresponds to the rated current of the AC drive. It is recommended to start with a low DC Braking Current level and then increase it slowly until proper holding torque has been attained. The amount of DC Braking Current cannot be higher than the rated current to avoid burning out the motor. So do not use DC brake of the motor drive as the mechanical latching to prevent accidents.
- 📖 When in FOCPG/TQCPG/FOCPM control mode, DC brake can be enabled without setting up Pr07-30.

08 PM Parameters

08-00

Motor Auto Tuning

Control Mode

FOCPM

Factory Setting: 0

Settings 0: No function

1: Only for the unloaded motor, auto measure the angle between magnetic pole and PG origin (08-09)

2: For PM parameters (brake locked)

3: Auto measure the angle between magnetic pole and PG origin (08-09)



For setting 1: It can auto measure the angle between magnetic pole and PG origin. Follow the steps below when measuring:

1. Unload before tuning
2. If brake is controlled by drive, the drive will act by the normal operation to finish tuning after wiring and setting brake control parameter
3. brake is controlled by drive, the drive will act by the normal operation to finish tuning after wiring and setting brake control parameter



For setting 3: It can auto measure the angle between magnetic pole and PG origin. Follow the steps below when measuring:

1. It can be loaded motor or unloaded motor before tuning
2. If brake is controlled by drive, the drive will act by the normal operation to finish tuning after wiring and setting brake control parameters
3. If brake is controlled by the host controller, it needs to make sure that brake is in release state before tuning
4. Make sure the setting of Pr.10-02 is correct. Because the wrong setting of Pr.10-02 will cause wrong position of magnetic pole and also the wrong angle between magnetic pole and PG origin



For setting 2: Starting auto tuning by pressing RUN key and it will write the measure value into Pr.08-05, Pr.08-07 (Rs, Lq) and Pr.08-08 (back EMF).

The steps to AUTO-Tuning are: (Static measure)

1. Make sure that all the parameters are set to factory settings and the motor wiring is correct
2. Motor: Fill in Pr.08-01, Pr.08-02, Pr.08-03 and Pr.08-04 with correct values. Refer to motor capacity to set accel. /decel. time
3. When Pr.08-00 is set to 2, the AC motor drive will execute auto-tuning immediately after receiving a "RUN" command. (NOTE: the motor will run! The shaft needs to be locked with external force)
4. After executing, Check if all values are filled in Pr.08-05 and Pr.08-07

 **NOTE**

- The rated speed can't be larger or equal to 120f/p.
- Note that if the electromagnetic valve and brake is not controlled by the AC motor drive, release it manually
- It is recommended to set Pr.08-00 to 1 (unloaded motor) for the accurate calculation. If it needs to execute this function with loaded motor, balance the carriage before execution.
- If it doesn't allow balancing the carriage in the measured environment, it can set Pr.08-00=3 for executing this function. It can execute this function with loaded motor by setting Pr.08-00=3. It will have a difference of 15~30° by the different encoder type. Also refer to the reference table for tuning in Pr10-00 <PG Signal Type>.
- It will display the warning message "Auto tuning" on the digital keypad during measuring until the measure is finished. Then, the result will be saved into Pr.08-09.
- It will display "Auto Tuning Err" on the keypad when stopping by the fault of the AC motor drive or human factor to show the failed detection. At this moment, please check the connections of the wirings of the AC motor drives. If it displays "PG Fbk Error" on the digital keypad, please change the setting of Pr.10-02 (if it is set to 1, please change it to 2). If it displays "PG Fbk Loss" on the digital keypad, please check the feedback of Z-phase pulse.

08-01 Full-load Current of Motor

Control Mode	FOCPM	Unit: Amp
		Factory Setting: ###
Settings (40~120%) *00-01 Amps		

 This value should be set according to the rated frequency of the motor as indicated on the motor nameplate. The factory setting is 90% X rated current.
 Example: if the rated current for 7.5hp (5.5kW) models is 25A and the factory setting is 22.5A. In this way, the current range will be from 10A (25*40%) to 30A (25*120%).

 ↗ **08-02** Rated Power of Motor

Control Mode	FOCPM	Factory Setting: ###
Settings 0.00~655.35 kW		

 It is used to set rated power of the motor. The factory setting is the power of the drive.

 ↗ **08-03** Rated Speed of Motor (rpm)

Control Mode	FOCPM	Factory Setting: 1710
Settings 0~65535 rpm		

 It is used to set the rated speed of the motor and need to set according to the value indicated on the motor nameplate.

08-04 Number of Motor Poles

Control Mode	FOCPM	Factory Setting:4
Settings	2~96	

 It is used to set the number of motor poles (must be an even number).

08-05 Rs of Motor

Control Mode	FOCPM	Factory Setting:0.000
Settings	0.000~65.535Ω	

08-06 Ld of Motor**08-07** Lq of Motor

Control Mode	FOCPM	Factory Setting:0.0
Settings	0.0~6553.5mH	

08-08 Back Electromotive Force

Control Mode	FOCPM	Factory Setting:0.0
Settings	0.0~6553.5Vrms	

 This parameter is used to set back electromotive force (phase-phase RMS value) when the motor is operated in the rated speed.

 It can get RMS value by Pr.08-00=2 (Motor Auto Tuning).

08-09 Angle between Magnetic Pole and PG Origin

Control Mode	FOCPM	Factory Setting:360.0
Settings	0.0~360.0°	

 This function is used to measure the angle between magnetic pole and PG origin.

08-10 Magnetic Pole Re-orientation

Control Mode	FOCPM	Factory Setting: 0
Settings	0: Disable 1: Enable	

 Use with Pr.11-00 bit15=1.

 This function is used for searching magnetic pole position and only for permanent magnet motor.

 When it doesn't have origin-adjustment for encoder (Pr.08-09 is 360.0), it can only ensure that the motor operation efficiency can be up to 86% of the best efficiency. In this situation, when the operation efficiency needs to be improved, user can re-power on or set Pr.08-10 to 1 to get the magnetic pole orientation

09 Communication Parameters

When using communication devices, connects AC drive with PC by using Delta IFD6530 or IFD6500.

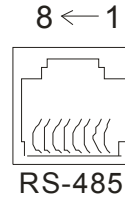

Modbus RS-485

Pin 1~2,7,8: Reserved

Pin 3, 6: GND

Pin 4: SG-

Pin 5: SG+

09-00 Communication Address

Factory Setting:1

Settings 1~254

If the AC motor drive is controlled by RS-485 serial communication, the communication address for this drive must be set via this parameter. And the communication address for each AC motor drive must be different and unique.

09-01 Transmission Speed

Control Mode **VF** **VFP** **SVC** **FOCP** **TQCP** **FOCP**

Factory Setting:19.2

Settings 4.8~115.2kbts/s

This parameter is used to set the transmission speed between the RS485 master (PLC, PC, etc.) and AC motor drive.

09-02 Transmission Fault Treatment

Control Mode **VF** **VFP** **SVC** **FOCP** **TQCP** **FOCP**

Factory Setting:3

Settings 0: Warn and keep operating

1: Warn and RAMP to stop

2: Reserved

3: No action and no display

This parameter is set to how to react if transmission errors occur.

09-03 Time-out Detection

Control Mode **VF** **VFP** **SVC** **FOCP** **TQCP** **FOCP**

Factory Setting:0.0

Settings 0.0~100.0sec

0.0: disable

It is used to set the communication time-out time.

Control Mode **VF** **VFP** **SVC** **FOCPG** **TQCPG** **FOCPM** Factory Setting:13

- Settings
- 0 : 7 · N · 1 for ASCII
 - 1 : 7 · N · 2 for ASCII
 - 2 : 7 · E · 1 for ASCII
 - 3 : 7 · O · 1 for ASCII
 - 4 : 7 · E · 2 for ASCII
 - 5 : 7 · O · 2 for ASCII
 - 6 : 8 · N · 1 for ASCII
 - 7 : 8 · N · 2 for ASCII
 - 8 : 8 · E · 1 for ASCII
 - 9 : 8 · O · 1 for ASCII
 - 10 : 8 · E · 2 for ASCII
 - 11 : 8 · O · 2 for ASCII
 - 12 : 8 · N · 1 for RTU
 - 13 : 8 · N · 2 for RTU
 - 14 : 8 · E · 1 for RTU
 - 15 : 8 · O · 1 for RTU
 - 16 : 8 · E · 2 for RTU
 - 17 : 8 · O · 2 for RTU

 Control by PC or PLC (Computer Link)

Users can select the desired mode along with the RS-485 serial port communication protocol in Pr.09-00.

 MODBUS ASCII(American Standard Code for Information Interchange): Each byte data is the combination of two ASCII characters. For example, a 1-byte data: 64 Hex, shown as '64' in ASCII, consists of '6' (36Hex) and '4' (34Hex).

1. Code Description:

Communication protocol is in hexadecimal, ASCII: "0", "9", "A", "F", every 16 hexadecimal represents ASCII code. For example:

Character	'0'	'1'	'2'	'3'	'4'	'5'	'6'	'7'
ASCII code	30H	31H	32H	33H	34H	35H	36H	37H

Character	'8'	'9'	'A'	'B'	'C'	'D'	'E'	'F'
ASCII code	38H	39H	41H	42H	43H	44H	45H	46H

2. Data Format

10-bit character frame (For ASCII):

(Format: 7, N, 2)

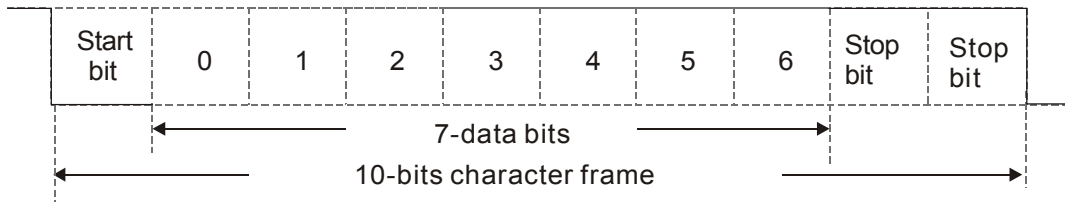

(Format: 7, E, 1)

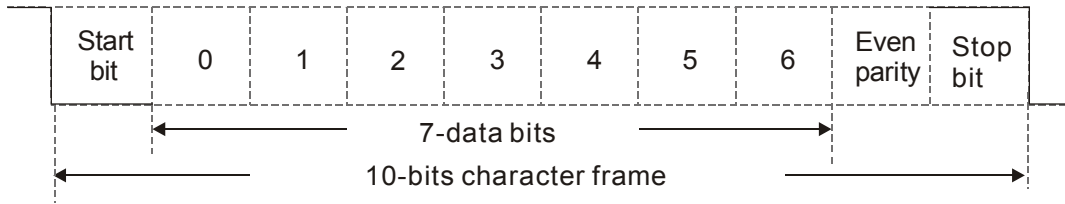

(Format: 7, O, 1)

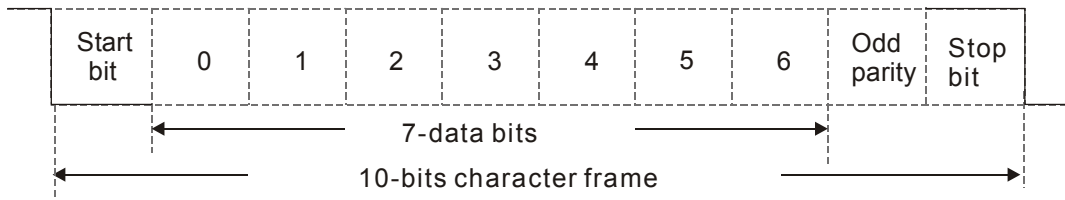

11-bit character frame (For RTU)

(Format: 8, N, 2)

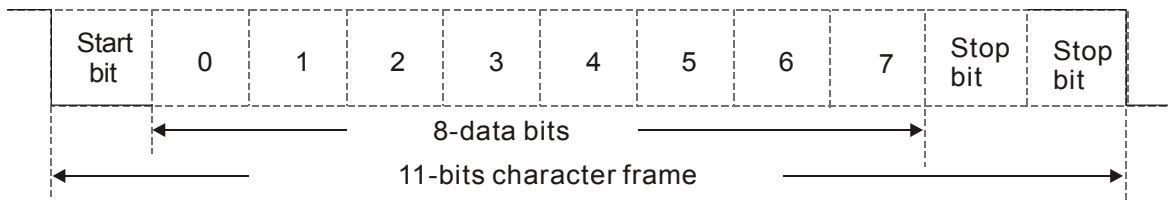

(Format: 8, E, 1)

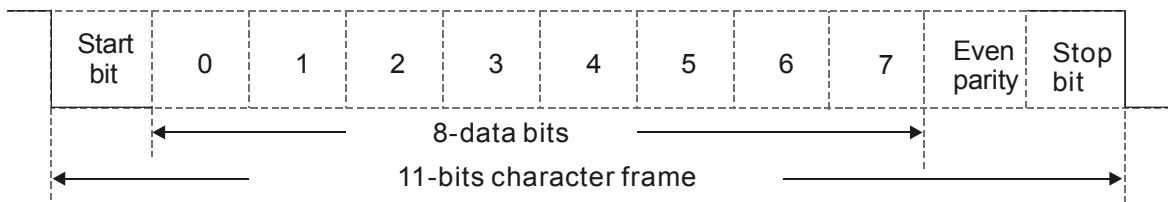

(Format 8, O, 1)

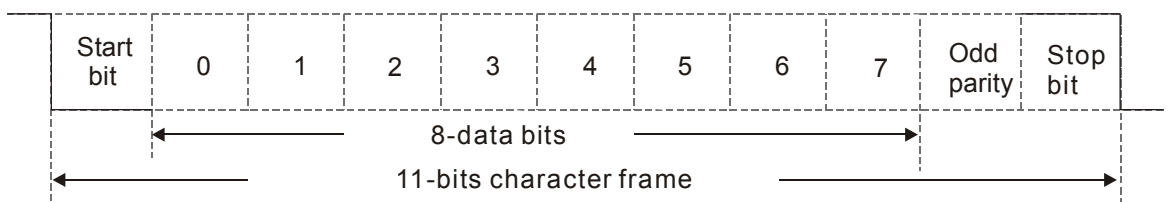

3. Communication Protocol

3.1 Communication Data Frame

ASCII mode

STX	Start character ‘:’ (3AH)
Address Hi	Communication address:
Address Lo	8-bit address consists of 2 ASCII codes
Function Hi	Command code:
Function Lo	8-bit command consists of 2 ASCII codes
DATA (n-1) to DATA 0	Contents of data: Nx8-bit data consist of 2n ASCII codes n<=16, maximum of 32 ASCII codes
LRC CHK Hi	LRC check sum:
LRC CHK Lo	8-bit check sum consists of 2 ASCII codes
END Hi	End characters:
END Lo	END1= CR (0DH), END0= LF(0AH)

RTU mode:

START	A silent interval of more than 10 ms
Address	Communication address: 8-bit address
Function	Command code: 8-bit command
DATA (n-1) to DATA 0	Contents of data: n×8-bit data, n<=16
CRC CHK Low	CRC check sum:
CRC CHK High	16-bit check sum consists of 2 8-bit characters
END	A silent interval of more than 10 ms

3.2 Address (Communication Address)

Valid communication addresses are in the range of 0 to 254. A communication address equal to 0 means broadcast to all AC drives (AMD). In this case, the AMD will not reply any message to the master device.

00H: broadcast to all AC drives

01H: AC drive of address 01

0FH: AC drive of address 15

10H: AC drive of address 16

:

FEH: AC drive of address 254

3.3 Function (Function code) and DATA (data characters)

The format of data characters depends on the function code.

(1) 03H: read data from register

Example: reading continuous 2 data from register address 2102H, AMD address is 01H.

ASCII mode:

Command Message:		Response Message:	
STX	'.'	STX	'.'
Address	'0'	Address	'0'
	'1'		'1'
Function	'0'	Function	'0'
	'3'		'3'
Starting address	'2'	Number of data (count by byte)	'0'
	'1'		'4'
	'0'	Content of starting address 2102H	'1'
	'2'		'7'
Number of data (count by word)	'0'	Content of address 2103H	'7'
	'0'		'0'
	'0'		'0'
	'2'		'0'
LRC Check	'D'	LRC Check	'0'
	'7'		'0'
END	CR	END	'7'
	LF		'1'
			CR
			LF

RTU mode:

Command & Message:		Response Message:	
Address	01H	Address	01H
Function	03H	Function	03H
Starting data address	21H	Number of data (count by byte)	04H
	02H		Content of data address 2102H
Number of data (count by world)	00H		17H
	02H		70H
CRC CHK Low	6FH	Content of data address 2103H	00H
CRC CHK High	F7H		00H
		CRC CHK Low	FEH
		CRC CHK High	5CH

(2) 06H: single write, write single data to register.

Example: writing data 6000(1770H) to register 0100H. AMD address is 01H.

ASCII mode:

Command & Message:		Response Message:	
STX	'.'	STX	'.'
Address	'0'	Address	'0'
	'1'		'1'
Function	'0'	Function	'0'
	'6'		'6'
Data address	'0'	Data address	'0'
	'1'		'1'
	'0'		'0'
	'0'		'0'
Data content	'1'	Data content	'1'
	'7'		'7'
	'7'		'7'
	'0'		'0'
LRC Check	'7'	LRC Check	'7'
	'1'		'1'
END	CR	END	CR
	LF		LF

RTU mode:

Command & Message:		Response Message:	
Address	01H	Address	01H
Function	06H	Function	06H
Data address	01H	Data address	01H
	00H		00H
Data content	17H	Data content	17H
	70H		70H
CRC CHK Low	86H	CRC CHK Low	86H
CRC CHK High	22H	CRC CHK High	22H

(3) 10H: write multiple registers (write multiple data to registers) (at most 20 sets of data can be written simultaneously)

Example: Set the multi-step speed,

Pr.04-00=50.00 (1388H), Pr.04-01=40.00 (0FA0H). AC drive address is 01H.

ASCII mode

Command Message:		Response Message:	
STX	':'	STX	':'
ADR 1	'0'	ADR 1	'0'
ADR 0	'1'	ADR 0	'1'
CMD 1	'1'	CMD 1	'1'
CMD 0	'0'	CMD 0	'0'
Target Register	'0'	Target Register	'0'
	'5'		'5'
	'0'		'0'
	'0'		'0'
Number of Register (Count by word)	'0'	Number of Register (Count by word)	'0'
	'0'		'0'
	'0'		'0'
	'2'		'2'
Number of Register (Count by byte)	'0'	LRC Check	'E'
	'4'		'8'
The first data content	'1'	END	CR
	'3'		LF
	'8'		
	'8'		
The second data content	'0'		
	'F'		
	'A'		
	'0'		
LRC Check	'9'		
	'A'		
END	CR		
	LF		

RTU mode

Command Message:		Response:	
ADR	01H	ADR	01H
CMD	10H	CMD 1	10H
Target Register	05H	Target Register	05H
	00H		00H
Number of Register (Count by word)	00H	Number of Register (Count by word)	00H
	02H		02H
Number of Register(Byte)	04	CRC Check Low	41H
The first Data content	13H	CRC Check High	04H
	88H		
The second Data content	0FH		
	A0H		
CRC Check Low	'9'		
CRC Check High	'A'		

3.4 Check Sum**ASCII mode (LRC Check)**

LRC (Longitudinal Redundancy Check) is calculated by summing up the values of the bytes from ADR1 to the last data character then calculating the hexadecimal representation of the 2's-complement negation of the sum.

For example,

$01H+03H+21H+02H+00H+02H=29H$, the 2's-complement negation of 29H is **D7H**.

RTU mode (CRC check)

CRC (Cyclical Redundancy Check) is calculated by the following steps:

Step 1: Load a 16-bit register (called CRC register) with FFFFH.

Step 2: Exclusive OR the first 8-bit byte of the command message with the low order byte of the 16-bit CRC register, putting the result in the CRC register.

Step 3: Examine the LSB of CRC register.

Step 4: If the LSB of CRC register is 0, shift the CRC register one bit to the right with MSB zero filling, then repeat step 3. If the LSB of CRC register is 1, shift the CRC register one bit to the right with MSB zero filling, Exclusive OR the CRC register with the polynomial value A001H, then repeat step 3.

Step 5: Repeat step 3 and 4 until eight shifts have been performed. When this is done, a complete 8-bit byte will have been processed.

Step 6: Repeat step 2 to 5 for the next 8-bit byte of the command message. Continue doing this until all bytes have been processed. The final contents of the CRC register are the CRC value. When transmitting the CRC value in the message, the upper and lower bytes of the CRC value must be swapped, i.e. the lower order byte will be transmitted first.

The following is an example of CRC generation using C language. The function takes two arguments:

```
unsigned char* data    ← // a pointer to the message buffer
unsigned char length  ← // the quantity of bytes in the message buffer
unsigned int crc_chk(unsigned char* data, unsigned char length)
{
    int j;
    unsigned int reg_crc=0xffff;
    while(length--){
        reg_crc ^= *data++;
        for(j=0;j<8;j++){
            if(reg_crc & 0x01){ /* LSB(b0)=1 */
                reg_crc=(reg_crc>>1) ^ 0xa001;
            }else{
                reg_crc=reg_crc >>1;
            }
        }
    }
}

return reg_crc;                // return register to CRC
```

3.5 Address List

The contents of available addresses are shown as below:

Content	Address	Function	
AC drive Parameters	GGnnH	GG means parameter group, nn means parameter number, for example, the address of Pr 4-01 is 0401H. Referencing to chapter 5 for the function of each parameter. When reading parameter by command code 03H, only one parameter can be read at one time.	
Command Write only	2000H	Bit 0-3	0: No function 1: Stop 2: Run 3: Jog + Run
Status monitor Read only	2001H	Bit 4-5	00B: No function 01B: FWD 10B: REV 11B: Change direction
		Bit 6-7	00B: 1st accel/decel 01B: 2nd accel/decel 10B: 3rd accel/decel 11B: 4th accel/decel
		Bit 8-11	Represented 16 step speeds.
		Bit 12	1: Enable bit 06-11
		Bit 13~14	00B: No function
			01B: operated by digital keypad
			02B: operated by Pr.00-15 setting
	Bit 15	Reserved	
	2002H	Frequency command	
	2002H	Bit 0	1: EF (external fault) on
		Bit 1	1: Reset
		Bit 2	1: B.B. ON
		Bit 3-15	Reserved
	2100H	Fault code: refer to Pr.06-16 to Pr.06-21	
	2119H	Bit 0-Bit 1	00: Stop
			01: deceleration
			10: Ready for operation
			11: operation
		Bit 2	1:JOG command
		Bit 3-Bit 4	00: FWD command, FWD output
			01: FWD command, REV output
			10: REV command, FWD output
			11: Reserved
		Bit 5	Reserved
Bit 6		Reserved	
Bit 7		Reserved	
Bit 8		1: Master frequency Controlled by communication interface	
Bit 9		1: Master frequency controlled by analog/external terminals signal	
Bit 10	1: Operation command controlled by communication interface		
Bit 11	1: Parameters have been locked		
Bit 12	1: enable to copy parameter from keypad		
Bit 13-15	Reserved		
2102H	Frequency command (F)		
2103H	Output frequency (H)		
2104H	Output current (AXXX.X)		
2105H	DC-BUS Voltage (UXXX.X)		
2106H	Output voltage (EXXX.X)		
2107H	Current step number of Multi-Step Speed Operation		
2116H	Multi-function display (Pr.00-04)		
2201H	Pr.00-05 user-defined setting		
2203H	AUI1 analog input (XXX.XX %)		
2204H	ACI analog input (XXX.XX %)		

Content	Address	Function
	2205H	AUI2 analog input (XXX.XX %)
	2206H	Display temperature of IGBT (°C)
	2207H	Display temperature of heatsink (°C) (only for model 40HP and above)
	2208H	Digital input state
	2209H	Digital output state

3.6 Exception Response

The AC motor drive is expected to return a normal response after receiving command messages from the master device. The following depicts the conditions when no normal response is replied to the master device.

The AC motor drive does not receive the messages due to a communication error; thus, the AC motor drive has no response. The master device will eventually process a timeout condition.

The AC motor drive receives the messages without a communication error, but cannot handle them. An exception response will be returned to the master device and an error message “CExx” will be displayed on the keypad of AC motor drive. The xx of “CExx” is a decimal code equal to the exception code that is described below.

In the exception response, the most significant bit (bit7) of the original command code is set to 1 (function code and 80H), and an exception code which explains the condition that caused the exception is returned.

Example:

ASCII mode:		RTU mode	
STX	‘.’	Address	01H
Address	‘0’	Function	86H
	‘1’	Exception code	02H
Function	‘8’	CRC CHK Low	C3H
	‘6’	CRC CHK High	A1H
Exception code	‘0’		
	‘2’		
LRC CHK	‘7’		
	‘7’		
END	CR		
	LF		

Description of Exception Codes:

Exception Code	Description
1	Illegal function code: The function code received in the command message is not available for the AC motor drive.
2	Illegal data address: The data address received in the command message is not available for the AC motor drive.
3	Illegal data value: The data value received in the command message is not available for the AC drive.
4	Slave device failure: The AC motor drive is unable to perform the requested action.
10	Communication time-out: If Pr.09-03 is not equal to 0.0, Pr.09-02=0~1, and there is no communication on the bus during the Time Out detection period (set by Pr.09-03), “cE10” will be shown on the keypad.

↗ **09-05** Response Delay Time

Control Mode **VF VFPG SVC FOC PG TQCPG FOC PM** Factory Setting:2.0
 Settings 0.0~200.0ms

📖 In case if the host computer didn't finish the transmitting/receiving process, this parameter is the response delay time after AC drive receives communication command as shown in the following.

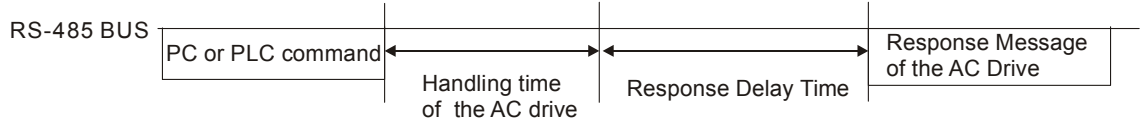

↗ **09-06** Direct docking mode only ◆

~
09-13

Control Mode **VF VFPG SVC FOC PG FOC PM** Factory Setting:
 Settings Contact Delta for more information

10 Speed Feedback Control Parameters

In this parameter group, ASR is the abbreviation for Adjust Speed Regulator and PG is the abbreviation for Pulse Generator.

10-00

Selection of Encoder

Control Mode **VFPG** **FOCPG TQCPG FOCPM** Factory Setting: 0

Settings 0: Disable
 1: ABZ
 2: ABZ+Hall
 3: SIN/COS + Sinusoidal
 4: SIN/COS + Endat
 5: SIN/COS
 6: SIN/COS + Hiperface

When Pr.10-00 is set to 3, encoder will have one sine and one cosine signal for each revolution. The signal must be: 0.75 to 1.2Vpp for the amplitude with phase angle $90^{\circ} \pm 5$ elec. (EX: ERN 1185 ERN 1387)

When setting is 4 or 6, it needs to wait for 2 seconds after applying the power to execute RUN command.

Detection of the magnetic pole:

Setting 1 or 5: The AC motor drive will output short circuit to detect the position of the magnetic pole. At this moment, the motor will generate a little noise.

Setting 2: The AC motor drive will detect the position of the magnetic pole by the UVW signal of encoder.

Setting 3: The AC motor drive will detect the position of the magnetic pole by the sine signal of encoder.

Setting 4 or 6: The AC motor drive will detect the position of the magnetic pole by the communication signal of encoder.

Reference table for tuning

Setting of PG signal type	PG signal type	Applicable PG card	Pr.08-00=1	Pr.08-00=3
10-00=1	A, B, Z	EMED-PGAB/ABD-1	N/A	N/A
10-00=2	A, B, Z+U, V, W	EMED-PGABD-1	Rolling test* ¹	Rolling test* ¹
10-00=3	SIN/COS+ Sinusoidal	EMED-PGHSD-1	Rolling test* ¹	Rolling test* ¹
10-00=4	SIN/COS+Endat	EMED-PGSD-1	Dynamic test* ¹	Static test* ¹
10-00=5	SIN/COS	EMED-PGHSD-1	N/A	N/A
10-00=6	SIN/COS + Hiperface	EMED-PGHSD-1	Dynamic test* ¹	Static test* ¹

*1 Static: Brake engaged, no motor running/ Dynamic: Brake released, motor rotates less than one round/ Rolling: Brake released, motor rotates more than one round.

10-01



Encoder Pulse

Control Mode **VFPG** **FOCPG TQCPG FOCPM** Factory Setting:2048

Settings 1~25000

A Pulse Generator (PG) or encoder is used as a sensor that provides a feedback signal of the motor speed. This parameter defines the number of pulses for each cycle of the PG control.

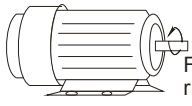
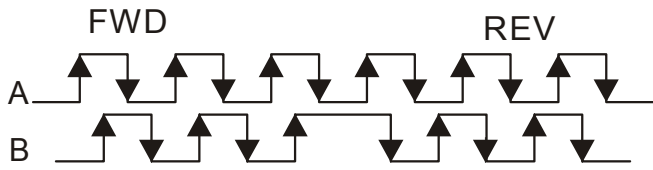
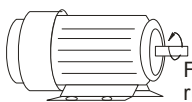
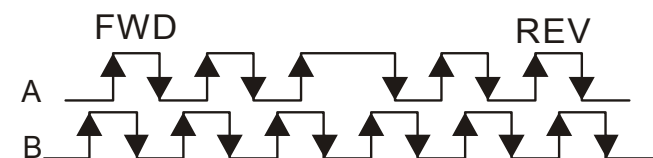
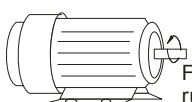
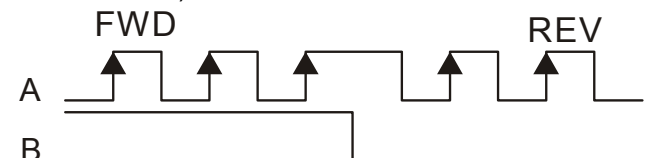
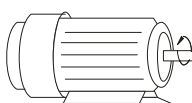
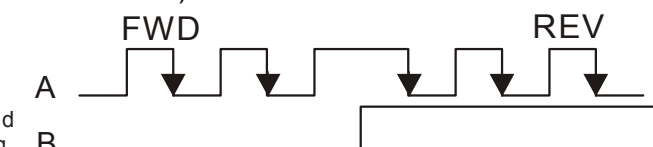
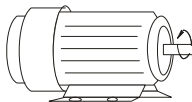
10-02 Encoder Input Type Setting

Control Mode	VFBPG	FOCPG	TQCPG	FOCPM	Factory Setting: 0
Settings	0	Disable			Phase A leads in a forward run command and phase B leads in a reverse run command
	1				Phase B leads in a forward run command and phase A leads in a reverse run command
	2				Phase A is a pulse input and phase B is a direction input. (low input=reverse direction, high input=forward direction)
	3				Phase A is a pulse input and phase B is a direction input. (low input=forward direction, high input=reverse direction)
	4				Single-phase input
	5				

 It is helpful for the stable control by inputting correct pulse type.

 When Pr10-00 is set as 3, 4, 5 or 6, Pr10-02 can only be set as 0, 1 or 2, while 3, 4 and 5 cannot be chosen.

10-03 Encoder Feedback Fault Treatment (PGF1, PGF2)

Control Mode	VFBPG	FOCPG	TQCPG	FOCPM	Factory Setting:2
Settings	0: Warn and keep operation				
	1: Fault and RAMP to stop				
	2: Fault and stop operation				

10-04 Detection Time for Encoder Feedback Fault

Control Mode	VFBPG	FOCPG	TQCPG	FOCPM	Factory Setting:1.0
Settings	0.0~10.0sec				

 When PG loss, encoder signal error, pulse signal setting error or signal error, if time exceeds the detection time for encoder feedback fault (Pr.10-04), the PG signal error will occur. Refer to the Pr.10-03 for encoder feedback fault treatment.

➤ **10-05** Encoder Stall Level (PGF3)

Control Mode	VFPG	SVC	FOCPG	FOCPM	Factory Setting:115
Settings	0~120%				
	0: Disable				

📖 This parameter determines the maximum encoder feedback signal allowed before a fault occurs. (max. output frequency Pr.01-00 =100%)

➤ **10-06** Encoder Stall Detection Time (maximum output frequency 01-00=100%)

Control Mode	VFPG	SVC	FOCPG	FOCPM	Factory Setting:0.1
Settings	0.0~2.0sec				

➤ **10-07** Encoder Slip Range (PGF4) (maximum output frequency 01-00=100%)

Control Mode	VFPG	SVC	FOCPG	FOCPM	Factory Setting:50
Settings	0~50%				
	0: Disable				

➤ **10-08** Encoder Slip Detection Time (maximum output frequency 01-00=100%)

Control Mode	VFPG	SVC	FOCPG	FOCPM	Factory Setting:0.5
Settings	0.0~10.0sec				

➤ **10-09** Encoder Stall and Slip Error Treatment (maximum output frequency 01-00=100%)

Control Mode	VFPG	SVC	FOCPG	FOCPM	Factory Setting:2
Settings	0: Warn and keep operating				
	1: Fault and RAMP to stop				
	2: Fault and COAST to stop				

📖 When the value of (rotation speed – motor frequency) exceeds Pr.10-07 setting, detection time exceeds Pr.10-08 or motor frequency exceeds Pr.10-05 setting, it will start to accumulate time. If detection time exceeds Pr.10-06, the encoder feedback signal error will occur. Refer to Pr.10-09 encoder stall and slip error treatment.



10-10 Mode Selection for UVW Input

Control Mode	VFPG	FOCPG	TQCPG	FOCPM	Factory Setting: 0
Settings	0: Z signal is at the falling edge of U-phase				
	1: Z signal is at the rising edge of U-phase				

📖 Setting 0: when the operation is U->V->W, Z signal is at the falling edge of U-phase.
Setting 1: when the operation is U->V->W, Z signal is at the rising edge of U-phase.

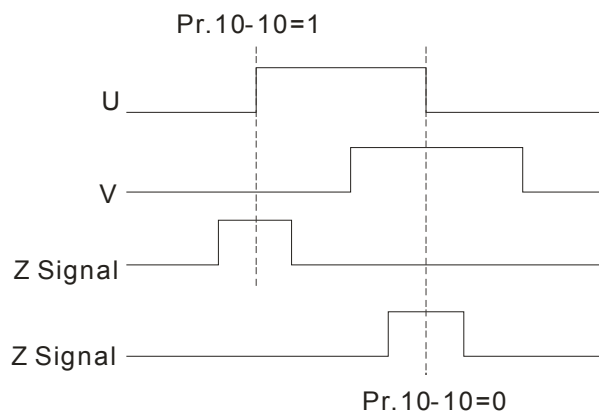

↗	10-11	ASR (Auto Speed Regulation) Control (P) of Zero Speed
Control Mode	VF VFPG SVC FOCPG FOCPM	Factory Setting:100.0
Settings	0.0~1000.0%	
↗	10-12	ASR (Auto Speed Regulation) Control (I) of Zero Speed
Control Mode	VF VFPG SVC FOCPG FOCPM	Factory Setting:0.100
Settings	0.000~10.000sec	
↗	10-13	ASR (Auto Speed Regulation) control (P) 1
Control Mode	VF VFPG SVC FOCPG FOCPM	Factory Setting:100.0
Settings	0.0~1000.0%	
↗	10-14	ASR (Auto Speed Regulation) control (I) 1
Control Mode	VF VFPG SVC FOCPG FOCPM	Factory Setting:0.100
Settings	0.000~10.000sec	
↗	10-15	ASR (Auto Speed Regulation) control (P) 2
Control Mode	VF VFPG SVC FOCPG FOCPM	Factory Setting:100.0
Settings	0.0~1000.0%	
↗	10-16	ASR (Auto Speed Regulation) control (I) 2
Control Mode	VF VFPG SVC FOCPG FOCPM	Factory Setting:0.100
Settings	0.000~10.000sec	
↗	10-17	ASR 1/ASR2 Switch Frequency
Control Mode	VF VFPG SVC FOCPG FOCPM	Factory Setting:7.00
Settings	0.00~400.00Hz	
		0: Disable

📖 ASR P determines Proportional control and associated gain (P). ASR I determines integral control and associated gain (I).

📖 When integral time is set to 0, it is disabled. Pr.10-17 defines the switch frequency for the ASR1 (Pr.10-13, Pr.10-14) and ASR2 (Pr.10-15, Pr.10-16).

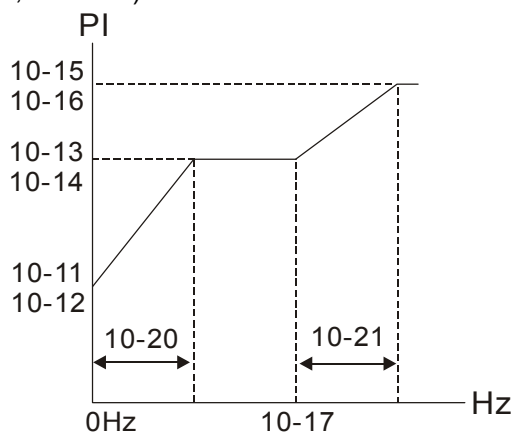

📖 When using multi-function input terminals to switch ASR1/ASR2, the diagram will be shown as follows.

Setting multi-function input terminal to 17
(ASR1/ASR2 switch)

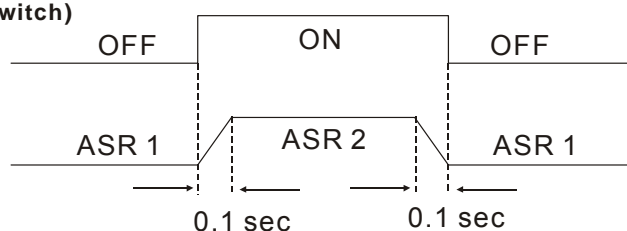

↗	10-18	ASR Primary Low Pass Filter Gain
Control Mode	VF VFPG SVC FOCPG	FOCPM Factory Setting:0.008
Settings	0.000~0.350sec	

- It defines the filter time of the ASR command.
- When setting to 1, this function is disabled.

↗	10-19	Zero Speed Gain (P)
Control Mode		FOCPM Factory Setting:80.00
Settings	0~655.00%	

- When Pr.11-00 is set to Bit 7=1, Pr.10-19 is valid

↗	10-20	Zero Speed/ASR1 Width Adjustment
Control Mode	VFPG FOCPG	FOCPM Factory Setting:5.00
Settings	0.00~400.00Hz	

↗	10-21	ASR1/ASR2 Width Adjustment
Control Mode	VFPG FOCPG	FOCPM Factory Setting:5.00
Settings	0.00~400.00Hz	

- These two parameters are used to decide width of slope of ASR command during zero speed to low speed or Pr.10-17 to high speed.

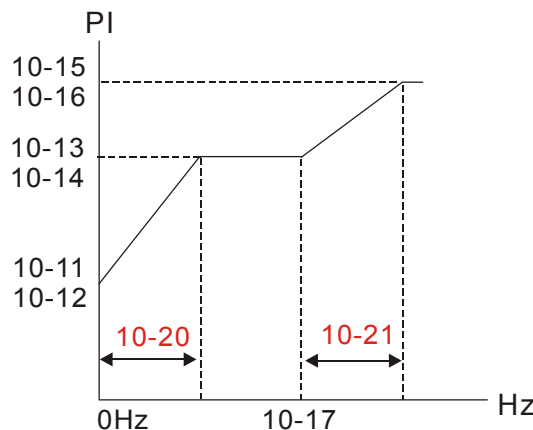

↗	10-22	Zero Speed Position Holding Time
Control Mode		FOCPM Factory Setting:0.250
Settings	0.001~65.535 sec	

↗	10-23	Filter Time at Zero Speed
Control Mode		FOCPM Factory Setting:0.004
Settings	0.001~65.535 sec	

↗	10-24	Time for Executing Zero Speed
Control Mode		FOCPM Factory Setting: 0
Settings	0: After the brake release set in Pr.02-29 1: After the brake signal input (Pr.02-01~02-08 is set to 42)	

- When Pr.10-24=0, the zero speed control needs to be used with Pr.02-29. (refer to the explanations in Pr.02-32)

↗	10-25	Elevator Leveling (Zero Speed Gain P)
Control Mode	VF VFPG SVC FOCPG	FOCPM Factory Setting:100.0
Settings	0~1000.0%	

↗	10-26	Elevator Leveling (Zero Speed Integral I)
Control Mode	VF VFP SVC FOCPG FOCPM	Factory Setting:0.100
Settings	0.000~10.000sec.	

↗	10-27	Elevator Starting (Zero Speed Gain P)
Control Mode	VF VFP SVC FOCPG FOCPM	Factory Setting:100.0
Settings	0.0~1000.0%	

↗	10-28	Elevator Starting (Zero Speed Integral I)
Control Mode	VF VFP SVC FOCPG FOCPM	Factory Setting:0.100
Settings	0.000~10.000sec.	

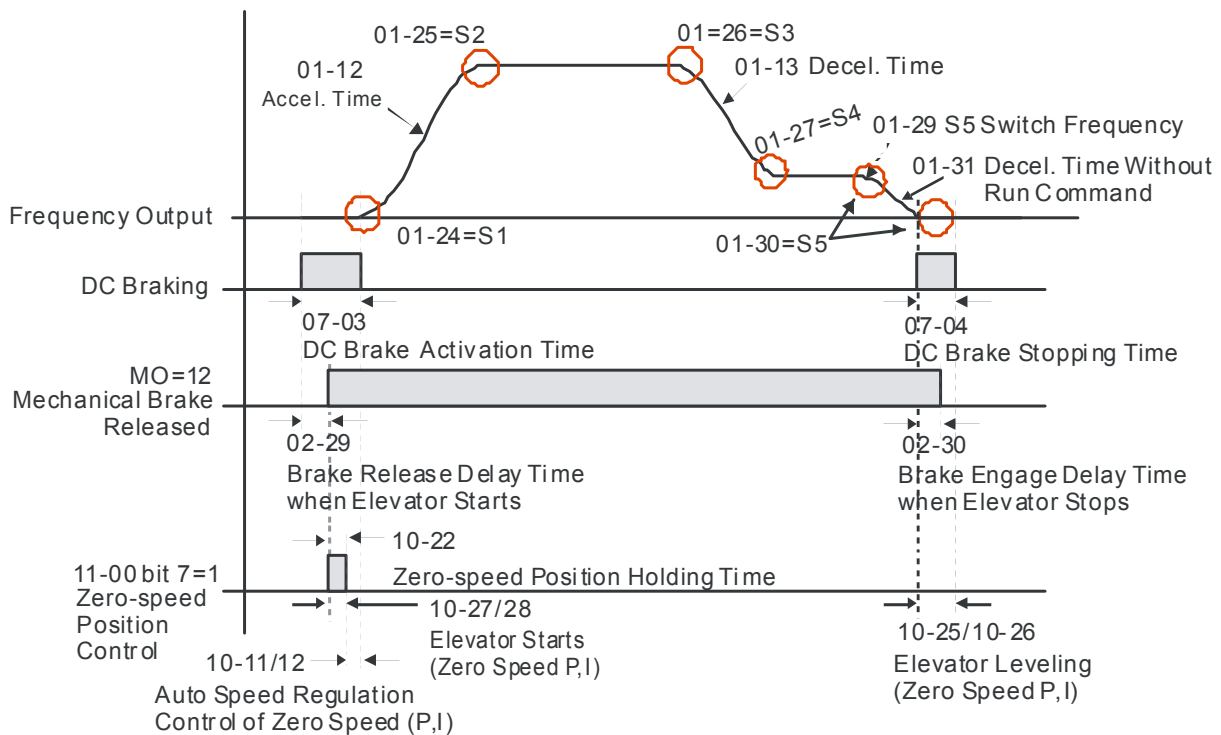

↗	10-29	Setting of PG card frequency division output
Control Mode	VFP FOCPG FOCPM	Factory Setting: 0
Settings	0~31	

↗	10-30	Type of PG card frequency division output
Control Mode	VFP FOCPG FOCPM	Factory Setting: 0000h
Settings	0000h~0008h	

📖 See CH07 for more information about PG card.

↗	10-31	Type of PG card frequency division output
Control Mode	VFP FOCPG FOCPM	Factory Setting: 0000h
Settings	0000h~0008h	

📖 When using Heidenhain ERN1387 encoder, adjust the definition of Delta PG card EMED-PGHSD-1's terminal 10 and terminal 11 by through Pr10-31.

📖 Delta PG card: EMED-PGHSD-1 (D-sub Terminal #)

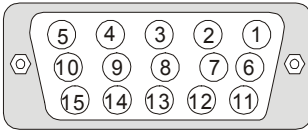

Heidenhain ERN1387		
Terminal #	10-31=0000h	10-31=0001
10	C-	C+
11	C+	C-

11 Advanced Parameters

11-00

System Control

Control Mode

FOCPG

FOCPM

Factory Setting: 0000h

Settings

Bit 0=0: No function

Bit 0=1: ASR Auto tuning, PDFF enable

Bit 7=0: No function

Bit 7=1: When position control is enabled, it doesn't need to set Pr.07-02 (DC Brake Current Level)

Bit 9=0: Rolling PG Origin auto-tuning with load (support by PGHSD-1)

Bit 9=1: Static PG Origin auto-tuning with load by enabling PGHSD-1

Bit 15=0: When power is applied, it will detect the position of magnetic pole again

Bit 15=1: when power is applied, it will start from the magnetic pole position of previous power failure

 Bit 0=1: PDFF function is enabled and system will generate an ASR setting, Pr. 10-11~10-16 will be invalid and Pr.11-09 to 11-10 will be valid.

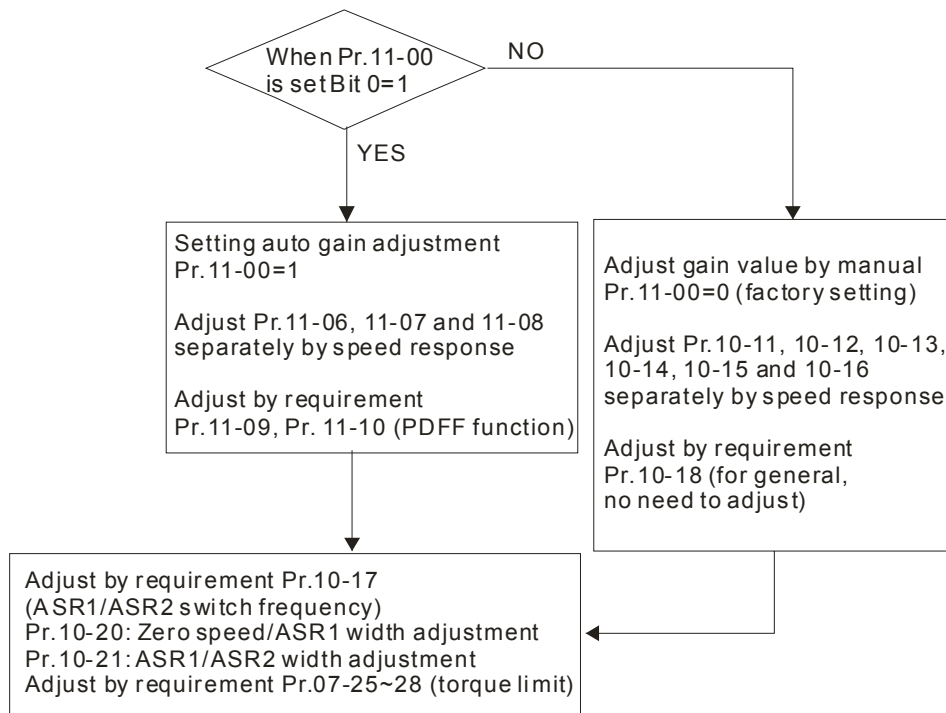

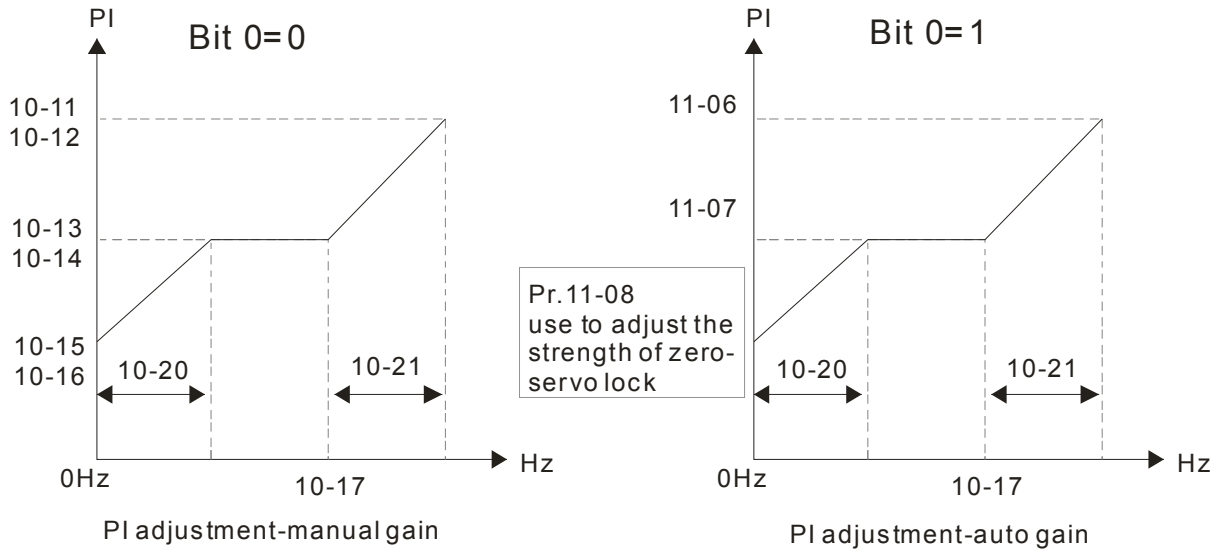

➤ **11-01** Elevator Speed

Control Mode	FOCPG	FOCPM	Factory Setting:1.00
Settings	0.10~4.00 m/s		

➤ **11-02** Sheave Diameter

Control Mode	FOCPG	FOCPM	Factory Setting:400
Settings	100~2000 mm		

➤ **11-03** Mechanical Gear Ratio

Control Mode	FOCPG	FOCPM	Factory Setting:1
Settings	1~100		

11-04 Suspension Ratio

Control Mode	FOCPG	FOCPM	Factory Setting:1
Settings	0= 1 : 1 1= 2 : 1		

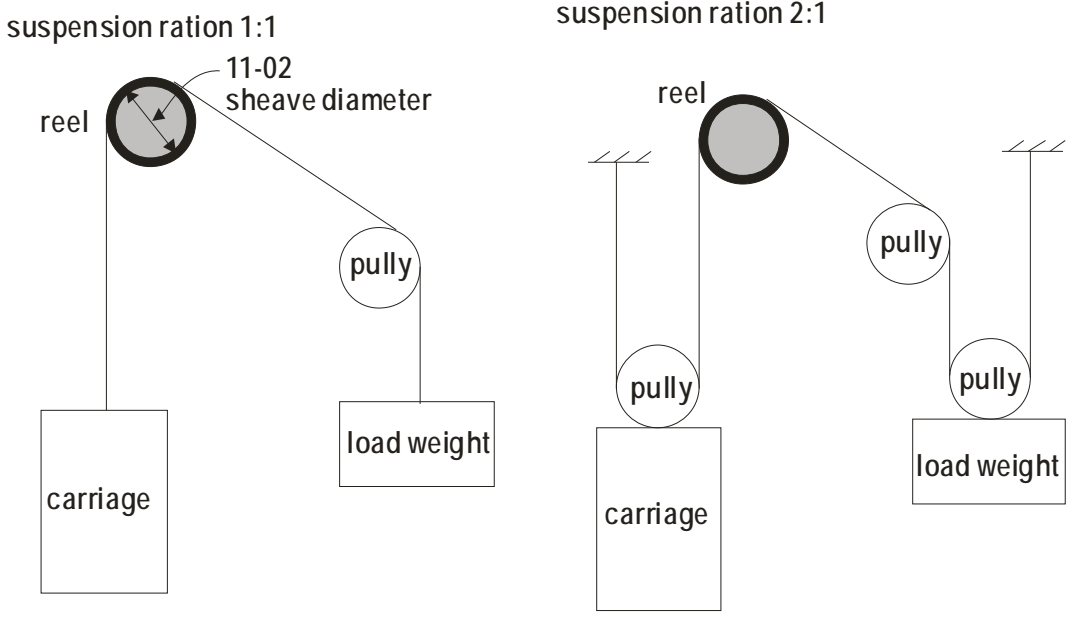

➤ **11-05** Inertial Ratio
 Control Mode **FOCPG** **FOCPM** Factory Setting:40
 Settings 1~300%

📖 The load inertia can be calculated by the settings of motor parameter, Pr.11-02 Sheave Diameter, Pr.11-14 Motor Current at Accel. and Pr.11-15 Elevator Acceleration. This parameter can be used to adjust inertia ratio of load.

➤ **11-06** Zero-speed Bandwidth
 Control Mode **FOCPG** **FOCPM** Factory Setting:10
 Settings 1~40Hz

➤ **11-07** Low-speed Bandwidth
 Control Mode **FOCPG** **FOCPM** Factory Setting:10
 Settings 1~40Hz

➤ **11-08** High-speed Bandwidth
 Control Mode **FOCPG** **FOCPM** Factory Setting:10
 Settings 1~40Hz

📖 After estimating inertia and set Pr.11-00=1 (auto tuning), user can adjust parameters Pr.11-06, 11-07 and 11-08 separately by speed response. The larger number you set, the faster response you will get. Pr.10-08 is the switch frequency for low-speed/high-speed bandwidth.

➤ **11-09** PDFF Gain Value
 Control Mode **FOCPG** **FOCPM** Factory Setting:30
 Settings 0~200%

📖 After finishing estimating and set Pr.11-00=1 (auto tuning), using Pr.11-09/11-10 to reduce overshoot. Please adjust PDFF gain value by actual situation.

📖 Besides traditional PI control, it also provides PDFF function to reduce overshoot for speed control.

1. Get system inertia
2. Set Pr.11-00 to 1
3. Adjust Pr.11-09/11-10 (the larger number is set and the suppressed overshoot function will be better. But it needs to be used by the actual condition)

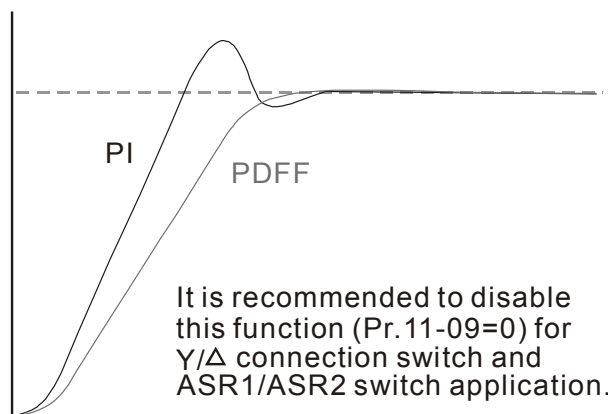

➤ **11-10** Gain for Speed Feed Forward
 Control Mode **FOCPG** **FOCPM** Factory Setting: 0
 Settings 0~500

📖 Pr.11-09 and Pr.11-10 will be enabled when Pr.11-00 is set to Bit0=1.

↗	11-11	Notch Filter Depth					
	Control Mode		FOCPG	FOCPM			Factory Setting: 0
	Settings	0~20db					
↗	11-12	Notch Filter Frequency					
	Control Mode		FOCPG	FOCPM			Factory Setting:0.00
	Settings	0.00~200.00Hz					
		<p>📖 This parameter is used to set resonance frequency of mechanical system. It can be used to suppress the resonance of mechanical system.</p> <p>📖 The larger number you set Pr.11-11, the better suppression resonance function you will get.</p> <p>📖 The notch filter frequency is the resonance of mechanical frequency.</p>					
↗	11-13	Low-pass Filter Time of Keypad Display					
	Control Mode	VF	VFPG	SVC	FOCPG	TQCPG	FOCPM
	Settings	0.001~65.535 sec					
		📖 It is used to lower the blinking frequency of LCD display.					
↗	11-14	Motor Current at Accel.					
	Control Mode				FOCPM		Factory Setting:150
	Settings	50~200%					
	11-15	Elevator Acceleration					
	Control Mode				FOCPM		Factory Setting:0.75
	Settings	0.20~2.00m/s ²					
↗	11-16	Reserved					
	Control Mode	VF	VFPG	SVC	FOCPG	TQCPG	FOCPM
	Settings	0000h~FFFFh					
↗	11-17	Reserved					
	Control Mode	VF	VFPG	SVC	FOCPG	TQCPG	FOCPM
	Settings	Read Only					
↗	11-18	Reserved					
	Control Mode	VF	VFPG	SVC	FOCPG	TQCPG	FOCPM
	Settings	0000h~FFFFh					
↗	11-19	Zero-speed Holding Bandwidth					
	Control Mode		FOCPG	FOCPM			Factory Setting:10
	Settings	1~40Hz					

12 User-defined Parameters

↗	12-00	Present Fault Record	Control Mode	VF	VFPG	SVC	FOCPG	TQCPG	FOCPM	Factory Setting: #.##
			Settings	0616						
↗	12-01	Present Fault Time of Motor Operation (min.)	Control Mode	VF	VFPG	SVC	FOCPG	TQCPG	FOCPM	Factory Setting: #. ##
			Settings	0632						
↗	12-02	Present Fault Time of Motor Operation (day)	Control Mode	VF	VFPG	SVC	FOCPG	TQCPG	FOCPM	Factory Setting: #.##
			Settings	0633						
↗	12-03	Frequency Command at Present Fault	Control Mode	VF	VFPG	SVC	FOCPG	TQCPG	FOCPM	Factory Setting: #.##
			Settings	0653						
↗	12-04	Output Frequency at Present Fault	Control Mode	VF	VFPG	SVC	FOCPG	TQCPG	FOCPM	Factory Setting: #.##
			Settings	0654						
↗	12-05	Output Current at Present Fault	Control Mode	VF	VFPG	SVC	FOCPG	TQCPG	FOCPM	Factory Setting: #.##
			Settings	0655						
↗	12-06	Motor Frequency at Present Fault	Control Mode	VF	VFPG	SVC	FOCPG	TQCPG	FOCPM	Factory Setting: #.##
			Settings	0656						
↗	12-07	Output Voltage at Present Fault	Control Mode	VF	VFPG	SVC	FOCPG	TQCPG	FOCPM	Factory Setting: #.##
			Settings	0657						
↗	12-08	DC-Bus Voltage at Present Fault	Control Mode	VF	VFPG	SVC	FOCPG	TQCPG	FOCPM	Factory Setting: #.##
			Settings	0658						
↗	12-09	Output Power at Present Fault	Control Mode	VF	VFPG	SVC	FOCPG	TQCPG	FOCPM	Factory Setting: #.##
			Settings	0659						

↗	12-10	Output Torque at Present Fault
Control Mode	VF VFPG SVC FOC PG TQCPG FOC PM	Factory Setting:###
Settings	0660	
↗	12-11	IGBT Temperature of Power Module at Present Fault
Control Mode	VF VFPG SVC FOC PG TQCPG FOC PM	Factory Setting:###
Settings	0661	
↗	12-12	Multi-function Terminal Input Status at Present Fault
Control Mode	VF VFPG SVC FOC PG TQCPG FOC PM	Factory Setting:###
Settings	0662	
↗	12-13	Multi-function Terminal Output Status at Present Fault
Control Mode	VF VFPG SVC FOC PG TQCPG FOC PM	Factory Setting:###
Settings	0663	
↗	12-14	Drive Status at Present Fault
Control Mode	VF VFPG SVC FOC PG TQCPG FOC PM	Factory Setting:###
Settings	0664	
↗	12-15	Second Most Recent Fault Record
Control Mode	VF VFPG SVC FOC PG TQCPG FOC PM	Factory Setting:###
Settings	0617	
↗	12-16	Second Most Recent Fault Time of Motor Operation (min.)
Control Mode	VF VFPG SVC FOC PG TQCPG FOC PM	Factory Setting:###
Settings	0634	
↗	12-17	Second Most Recent Fault Time of Motor Operation (day)
Control Mode	VF VFPG SVC FOC PG TQCPG FOC PM	Factory Setting:###
Settings	0635	
↗	12-18	Third Most Recent Fault Record
Control Mode	VF VFPG SVC FOC PG TQCPG FOC PM	Factory Setting:###
Settings	0618	
↗	12-19	Third Most Recent Fault Time of Motor Operation (min.)
Control Mode	VF VFPG SVC FOC PG TQCPG FOC PM	Factory Setting:###
Settings	0636	

↗	12-20	Third Most Recent Fault Time of Motor Operation (day)	Control Mode	VF	VFPG	SVC	FOCPG	TQCPG	FOCPM	Factory Setting:###
			Settings	0637						
↗	12-21	Fourth Most Recent Fault Record	Control Mode	VF	VFPG	SVC	FOCPG	TQCPG	FOCPM	Factory Setting:###
			Settings	0619						
↗	12-22	Fourth Most Recent Fault Time of Motor Operation (min.)	Control Mode	VF	VFPG	SVC	FOCPG	TQCPG	FOCPM	Factory Setting:###
			Settings	0638						
↗	12-23	Fourth Most Recent Fault Time of Motor Operation (min.)	Control Mode	VF	VFPG	SVC	FOCPG	TQCPG	FOCPM	Factory Setting:###
			Settings	0639						
↗	12-24	Fifth Most Recent Fault Record	Control Mode	VF	VFPG	SVC	FOCPG	TQCPG	FOCPM	Factory Setting:###
			Settings	0620						
↗	12-25	Fifth Most Recent Fault Time of Motor Operation (min.)	Control Mode	VF	VFPG	SVC	FOCPG	TQCPG	FOCPM	Factory Setting:###
			Settings	0640						
↗	12-26	Fifth Most Recent Fault Time of Motor Operation (day)	Control Mode	VF	VFPG	SVC	FOCPG	TQCPG	FOCPM	Factory Setting:###
			Settings	0641						
↗	12-27	Sixth Most Recent Fault Record	Control Mode	VF	VFPG	SVC	FOCPG	TQCPG	FOCPM	Factory Setting:###
			Settings	0621						
↗	12-28	Sixth Most Recent Fault Time of Motor Operation (min.)	Control Mode	VF	VFPG	SVC	FOCPG	TQCPG	FOCPM	Factory Setting:###
			Settings	0642						
↗	12-29	Sixth Most Recent Fault Time of Motor Operation (day)	Control Mode	VF	VFPG	SVC	FOCPG	TQCPG	FOCPM	Factory Setting:###
			Settings	0643						

↗ 12-30 No factory setting

↗ 12-31 No factory setting

12-00

~

User-defined Parameters

12-31

Control Mode **VF** **VFP** **SVC** **FOCPG** **TQCPG** **FOCPM** Factory Setting:-
 Settings -

📖 Users can enter the parameters from group 0 to group 11 into group 12 (it can save 32 parameters). The saved value can also be the parameter addresses (but the hexadecimal value needs to be converted to decimal value).

📖 Example 2: If it needs to enter parameter address 2102H and 211BH by the digital keypad, 211BH needs to be converted to binary value before entering.
 The setting method of 2102H

📖 **Examples of User-defined parameters**

Example 1: If you want to enter Pr.08-03 into Pr.12-00, you only need to enter 0803 into Pr.12-00. Then it will display the setting of Pr.08-03 in Pr.13-00.

Example 2: If it needs to enter parameter address 2102H and 211BH by the digital keypad, 211BH needs to be converted to binary value before entering.

The setting method of 211BH

Convert 211BH (hexadecimal) to decimal value:

$$\begin{array}{c}
 2 \ 1 \ 1 \ B \\
 \swarrow \quad \searrow \\
 1 \times 16^1 + 11 \times 16^0 = 16 + 11 = 27 \quad \text{input } 2127
 \end{array}$$

13 View User Defined Parameters

13-00

~

View User Defined Parameters

13-31

Control Mode **VF** **VFP** **SVC** **FOCPG** **TQCPG** **FOCPM**

Factory Setting:-

Settings -Pr00-00 to Pr11-19

13 Warning Codes

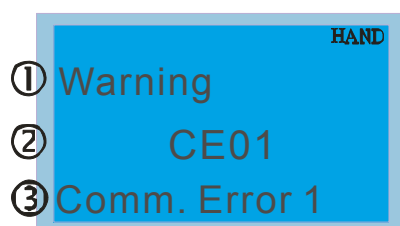

① Warning

② CE01



③ Comm. Error 1



① Display error signal

② Abbreviated error code
The code is displayed as shown on KPC-CE01.

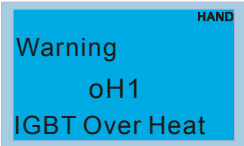
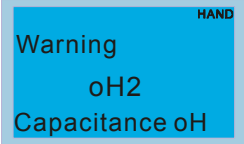
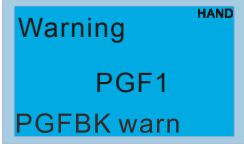
③ Display error description

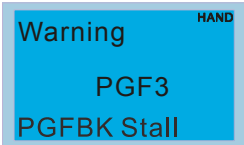
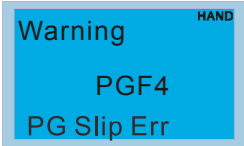
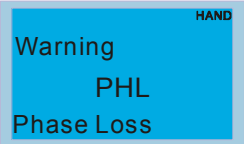
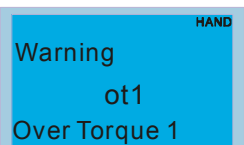
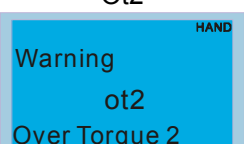
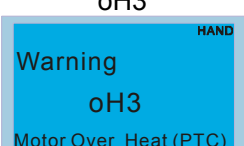
ID No.	Display on KPE-LE01	Display on LCM Keypad	Descriptions
1	CE01		Communication command defected Cause Communication error
2	CE02		Address of data defected Cause Communication error
3	CE03		Length of communication data defected Cause Communication error Communication error
4	CE04		Communications being written in a read only address. Cause Communication error
5	CE 10		Modbus transmission time-out Cause Communication error
6	CP 10		Keypad KPC-CC01 transmission time-out Cause Communication error
7	SE 1		Keypad copying parameter error 1 Cause Keypad simulation error, including communication delays, communication error (keypad received error FF86) and parameter value error.
8	SE2		Keypad copying parameter fail error 2 Cause keypad simulation done but parameter write error

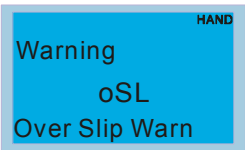
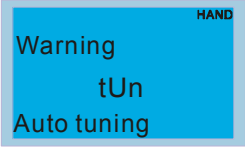
ID No.	Display on KPE-LE01	Display on LCM Keypad	Descriptions
9	oH1		IGBT over-heating warning Cause The temperature of the IGBT are over the factory setting 90°C (Pr06-14).
10	oH2		Capacitor over-heating warning Cause The temperature of the capacitor is over 65°C. .
15	P9F1		PG card feedback error Cause When Pr10-03 = 0 (factory setting = 2), a warning message will be displayed instead of a fault message while an error occurs.
16	P9F2		PG feedback loss warning Cause Pr10-03 = 0 (factory setting = 2), a warning message will be displayed instead of a fault message while an error occurs.
17	P9F3		PG feedback stall warning Cause Pr10-09 = 0 (factory setting = 2), a warning message will be displayed instead of a fault message while an error occurs.
18	P9F4		PG slip warning Cause Pr10-09 = 0 (factory setting = 2), a warning message will be displayed instead of a fault message while an error occurs.
19	PHL		Phase loss Cause When Pr06-01 =0 (factory setting = 2), a warning message will be given instead of a fault message while a phase loss occurs.
20	ot 1		Over torque 1 Cause When Pr06-05 =1 or 3 (factory setting = 2), a warning message will be given instead of a fault message while there is an over torque detection.
21	ot 2		Over torque 2 Cause When Pr06-05 =1 or 3 (factory setting = 2), a warning message will be given instead of a fault message while there is an over torque detection.
22	oH3		Motor over-heating (PTC) Cause When Pr06-26 =1 (factory setting = 0), a warning message will be given when there is a PTC detection.

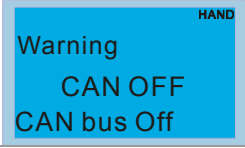
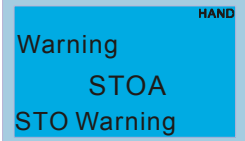
ID No.	Display on KPE-LE01	Display on LCM Keypad	Descriptions
24	oSL	<p>oSL</p> 	<p>Over slip</p> <p>Cause When Pr05-16 =0 (factory setting = 0), a warning message will be given while the slip deviation level is over the setting at Pr05-14 and the detection time is longer than the setting at Pr05-15.</p>
25	tUn	<p>tUn</p> 	<p>Auto tuning in process</p>
26	FAn	<p>FAn</p> 	<p>Fan stop turning</p> <p>Cause When Pr06-45 bit 1 =1, a warning message will be given when the cooling fan is locked (when bit1=1, there is an output error).</p>
27	dCAN	<p>dCAN</p> 	<p>CANbus off</p> <p>Cause Error(s) occurred on CANbus</p>
28	StOA	<p>StOA</p> 	<p>Safety Torque Off Alarm</p> <p>Cause Safety torque output is off and Pr06-49 =1 or 3.</p>

14 Fault Codes

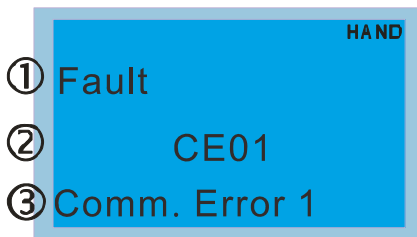

① Fault

② CE01

③ Comm. Error 1

① Display fault (error) signal.



② Abbreviated fault (error) code
The code is displayed as shown on KPC-CC01.

③ Display fault (error) description.

*In accordance with the settings of Pr06-16 ~ Pr06-21.

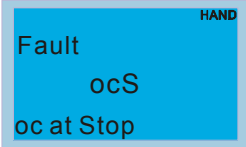
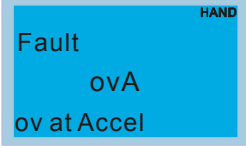
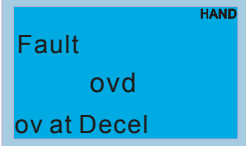
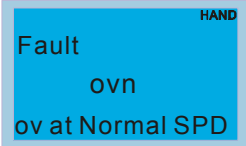
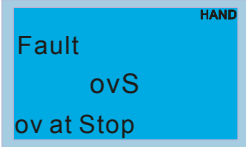
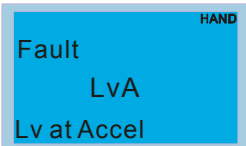
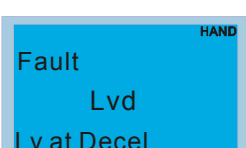

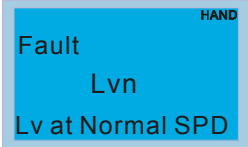
ID*	Display on KPE-LE01	LCM Panel Display	Descriptions
1	ocA		Over-current during acceleration (Output current exceeds triple rated current during acceleration.) corrective action <ol style="list-style-type: none"> Short-circuit at motor output: Check for possible poor insulation at the output. Acceleration Time is too short: Increase the Acceleration Time. AC motor drive output power is too small: Replace the AC motor drive with a higher power model.
2	ocD		Over-current during deceleration (Output current exceeds triple rated current during deceleration.) corrective action <ol style="list-style-type: none"> Short-circuit at motor output: Check for possible poor insulation at the output. Deceleration Time is too short: Increase the Deceleration Time. AC motor drive output power is too small: Replace the AC motor drive with a higher power model.
3	ocn		Over-current during steady state operation (Output current exceeds triple rated current during constant speed.) corrective action <ol style="list-style-type: none"> Short-circuit at motor output: Check for possible poor insulation at the output. Sudden increase in motor loading: Check for possible motor stall. AC motor drive output power is too small: Replace the AC motor drive with a higher power model.
4	GFF		Ground fault corrective action When (one of) the output terminal(s) is grounded, short circuit current is more than 50% of AC motor drive rated current, the AC motor drive power module may be damaged. NOTE: The short circuit protection is to protect the AC motor drive, not to protect the user. <ol style="list-style-type: none"> Check the wiring connections between the AC motor drive and motor for possible short circuits, also to ground. Check whether the IGBT power module is damaged. Check for possible poor insulation at the output.
5	occ		Short-circuit is detected between upper bridge and lower bridge of the IGBT module. corrective action Return to the factory.

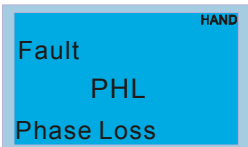
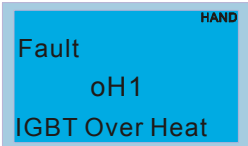
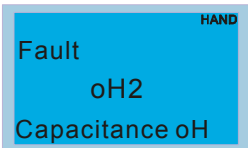
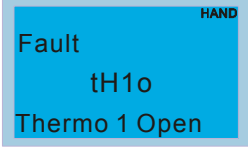
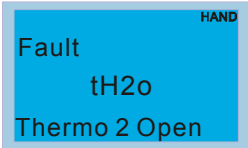
6	ocS		<p>Hardware failure in over current detection</p> <p>corrective action</p> <p>Return to the factory.</p>
7	ovA		<p>DC BUS over-voltage during acceleration</p> <p>230V: DC 405V; 460V: DC 810V</p> <p>corrective action</p> <ol style="list-style-type: none"> 1. Check if the input voltage falls within the rated AC motor drive input voltage range. 2. Check for possible voltage transients. 3. If DC BUS over-voltage due to regenerative voltage, increase the acceleration time or add an optional brake resistor.
8	ovd		<p>DC BUS over-voltage during deceleration</p> <p>230V: DC 405V; 460V: DC 810V</p> <p>corrective action</p> <ol style="list-style-type: none"> 1. Check if the input voltage falls within the rated AC motor drive input voltage range. 2. Check for possible voltage transients. 3. If DC BUS over-voltage due to regenerative voltage, increase the Deceleration Time or add an optional brake resistor.
9	ovn		<p>DC BUS over-voltage at constant speed</p> <p>230V: DC 405V; 460V: DC 810V</p> <p>corrective action</p> <ol style="list-style-type: none"> 1. Check if the input voltage falls within the rated AC motor drive input voltage range. 2. Check for possible voltage transients. 3. If DC BUS over-voltage due to regenerative voltage, increase the Deceleration Time or add an optional brake resistor.
10	ovS		<p>Hardware failure in voltage detection</p> <p>corrective action</p> <ol style="list-style-type: none"> 1. Check if the input voltage falls within the rated AC motor drive input voltage range. 2. Check for possible voltage transients.
11	LvA		<p>DC BUS voltage is less than the setting at Pr.06-00 during acceleration.</p> <p>corrective action</p> <ol style="list-style-type: none"> 1. Check if the input voltage is normal. 2. Check for possible sudden load.
12	Lvd		<p>DC BUS voltage is less than Pr.06-00 during deceleration.</p> <p>corrective action</p> <ol style="list-style-type: none"> 1. Check if the input voltage is normal. 2. Check for possible sudden load.

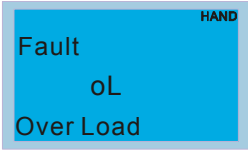
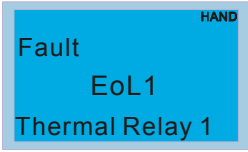
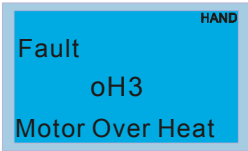
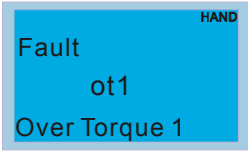
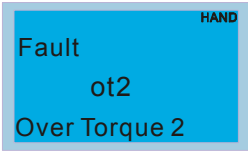
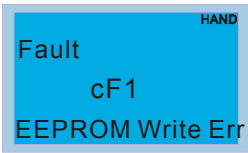
13	LvN	 <p>Fault LvN Lv at Normal SPD</p>	<p>DC BUS voltage is less than the setting at Pr.06-00 at constant speed</p> <p>corrective action</p> <ol style="list-style-type: none"> 1. Check if the input voltage is normal. 2. Check for possible sudden load.
14	LvS	 <p>Fault LvS Lv at Stop</p>	<p>DC BUS voltage is less than the setting at Pr.06-00 at stop.</p> <p>corrective action</p> <ol style="list-style-type: none"> 1. Check if the input voltage is normal. 2. Check for possible sudden load.
15	PHL	 <p>Fault PHL Phase Loss</p>	<p>Phase Loss</p> <p>corrective action</p> <p>Check Power Source Input if all 3 input phases are connected without loose contacts.</p>
16	oH1	 <p>Fault oH1 IGBT Over Heat</p>	<p>IGBT overheating IGBT temperature exceeds protection level 3~5HP, 50~60HP: 105°C 7.5~30HP: 95 °C 40~100HP: 110 °C</p> <p>corrective action</p> <ol style="list-style-type: none"> 1. Ensure that the ambient temperature falls within the specified temperature range. 2. Make sure that the ventilation holes are not obstructed. 3. Remove any foreign objects from the heatsinks and check for possible dirty heatsink fins. 4. Check the fan and clean it. 5. Provide enough spacing for adequate ventilation.
17	oH2	 <p>Fault oH2 Capacitance oH</p>	<p>Capacitor overheating. Capacitor's temperature exceeds the protection level. 3~100HP: 65°C.</p> <p>corrective action</p> <ol style="list-style-type: none"> 1. Ensure that the ambient temperature falls within the specified temperature range. 2. Make sure heat sink is not obstructed. Check if the fan is operating 3. Check if there is enough ventilation clearance for AC motor drive.
18	tH1o	 <p>Fault tH1o Thermo 1 Open</p>	<p>IGBT overheating protection fault</p> <p>corrective action</p> <p>Return to the factory.</p>
19	tH2o	 <p>Fault tH2o Thermo 2 Open</p>	<p>Capacitor module overheating fault</p> <p>corrective action</p> <p>Return to the factory.</p>

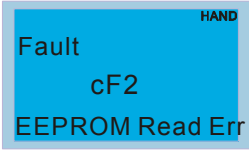
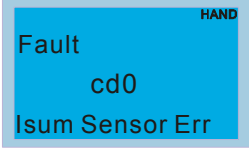
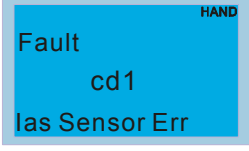
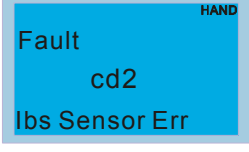
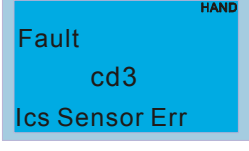
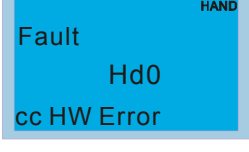
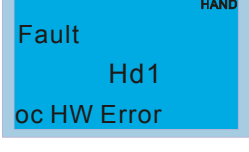
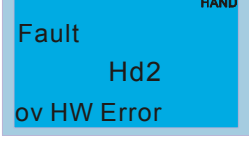
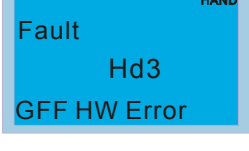
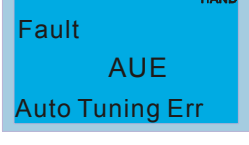
20	FAn		<p>Cooling fan doesn't turn properly</p> <p>corrective action</p> <p>Verify if the cooling fan is covered by dust and needs to be cleaned. Return to the factory if necessary.</p>
21	oL		<p>The AC motor drive detects excessive drive output current. The output current causes the motor drive to be overload. If the output current is 150% higher than the rated current, the motor drive can last for 60 seconds.</p> <p>corrective action</p> <ol style="list-style-type: none"> 1. Check if the motor is overload. 2. Increase the output capacity of the motor drive.
22	EoL1		<p>The output current causes the motor to be overload. If the output current is 150% higher than the rated current, the motor can last for 60 seconds.</p> <p>corrective action</p> <ol style="list-style-type: none"> 1. Check the setting of full-load current of motor (Pr.05-01). 2. Check if motor 1 is overload, change to a higher power motor.
24	oH3		<p>Motor overheating</p> <p>The AC motor drive detecting internal temperature exceeds the setting of Pr.06-27 (PTC level).</p> <p>corrective action</p> <ol style="list-style-type: none"> 1. Make sure that the motor is not obstructed. 2. Ensure that the ambient temperature falls within the specified temperature range. 3. Change to a higher power motor.
26	ot1		
27	ot2		<p>The ot1 and ot2 fault codes will pop up when:</p> <ul style="list-style-type: none"> - the output current exceeds the setting at Pr06-06 <Over-torque Detection Level (OT1)> and Pr06-09 <Over-torque Protection Level (OT2)>, - the output current lasts longer than the time setting at Pr06-07 and Pr06-10. - Pr06-05 or Pr06-08 is set to 2 or 4. <p>corrective action</p> <ol style="list-style-type: none"> 1. Check if the motor is overload. 2. Check if the setting of Pr05-01 IM <Full-load current of the motor>and Pr08-01 PM <Full-load current of the motor> are appropriate. 3. If necessary, increase the output capacity of the motor.
30	cF1		<p>Internal EEPROM cannot be programmed.</p> <p>corrective action</p> <ol style="list-style-type: none"> 1. Press "RESET" key to the factory setting. 2. Return to the factory.

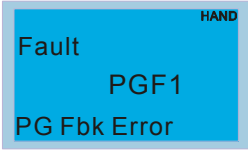
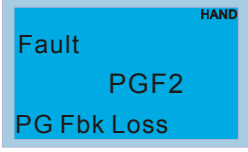
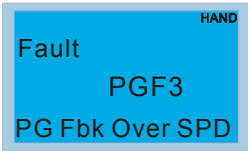
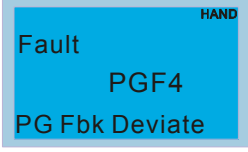
31	<i>cF2</i>	 <p>Fault cF2 EEPROM Read Err</p>	<p>Internal EEPROM cannot be read.</p> <p>corrective action</p> <ol style="list-style-type: none"> 1. Press "RESET" key to the factory setting. 2. Return to the factory.
32	<i>cd0</i>	 <p>Fault cd0 Isum Sensor Err</p>	<p>Hardware failure in current detection</p> <p>corrective action</p> <p>Reboot the power. If fault code is still displayed on the keypad, return to the factory.</p>
33	<i>cd1</i>	 <p>Fault cd1 Ias Sensor Err</p>	<p>U-phase current detection error</p> <p>corrective action</p> <p>Reboot the power. If fault code is still displayed on the keypad, return to the factory.</p>
34	<i>cd2</i>	 <p>Fault cd2 Ibs Sensor Err</p>	<p>V-phase current detection error</p> <p>corrective action</p> <p>Reboot the power. If fault code is still displayed on the keypad, return to the factory.</p>
35	<i>cd3</i>	 <p>Fault cd3 Ics Sensor Err</p>	<p>W-phase current detection error</p> <p>corrective action</p> <p>Reboot the power. If fault code is still displayed on the keypad, return to the factory.</p>
36	<i>Hd0</i>	 <p>Fault Hd0 cc HW Error</p>	<p>CC (current clamp)</p> <p>corrective action</p> <p>Reboot the power. If fault code is still displayed on the keypad, return to the factory.</p>
37	<i>Hd1</i>	 <p>Fault Hd1 oc HW Error</p>	<p>OC hardware error</p> <p>corrective action</p> <p>Reboot the power. If fault code is still displayed on the keypad, return to the factory.</p>
38	<i>Hd2</i>	 <p>Fault Hd2 ov HW Error</p>	<p>OV hardware error</p> <p>corrective action</p> <p>Reboot the power. If fault code is still displayed on the keypad, return to the factory.</p>
39	<i>Hd3</i>	 <p>Fault Hd3 GFF HW Error</p>	<p>GFF hardware error</p> <p>corrective action</p> <p>Reboot the power. If fault code is still displayed on the keypad, return to the factory.</p>
40	<i>AUE</i>	 <p>Fault AUE Auto Tuning Err</p>	<p>Auto-tuning error</p> <p>corrective action</p> <ol style="list-style-type: none"> 1. Check cabling between drive and motor 2. Check if the motor capacity and the parameter setting are appropriate. Then try again.

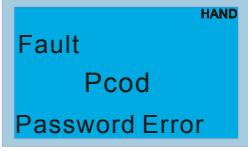
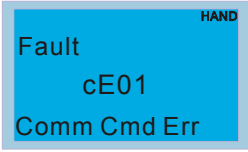
42	PGF1		PG feedback error corrective action .When PG feedback control is enabled; check if Pr10-01<Encoder Pulse> is set to 0.
43	PGF2		PG feedback loss corrective action Check the wiring of the PG feedback.
44	PGF3		PG feedback over speed corrective action 1. Check the wiring of the PG feedback. 2. Check if the settings of PI gain and deceleration are correct (Pr10-05, Pr10-06). 3. Return to the factory.
45	PGF4		PG slip error corrective action 1. Check the wiring of the PG feedback. 2. Check if the settings of PI gain and deceleration are appropriate (Pr10-07, Pr10-08). 3. Return to the factory.
49	EF		When Multi-Function Input Command (MI1 to MI8) is set to #10 EF input (Pr07-28) and when multi-function input terminals are triggered to close, the motor drive stop running. corrective action 1. Input EF (N.O.) on external terminal is closed to GND. Output U, V, W will be turned off. 2. Press the RESET button on the keypad to clear the fault signal. .
50	EF1		Emergency Stop corrective action 1. When the multi-function input terminals MI1 to MI6 are set to emergency stop, the AC motor drive stops outputting U, V, W and the motor coasts to stop. 2. Press RESET after fault has been cleared.
52	Pcod		Password error. After inputting three consecutive times the wrong password, the keypad will be locked. corrective action Power down and power back up again the motor drive to clear the lock and re-enter the correct password See Pr.00-07 and 00-08 for more information.
54	cE01		Illegal function code corrective action Check if the function code is correct (function code must be 03, 06, 10, 63).

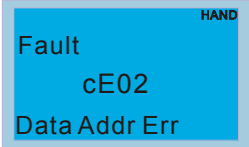
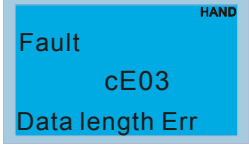
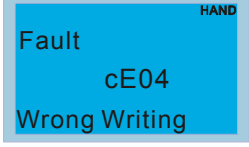
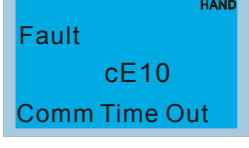
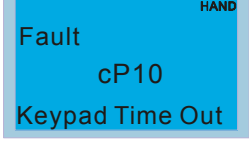
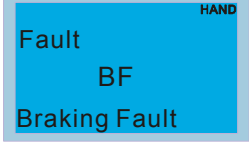
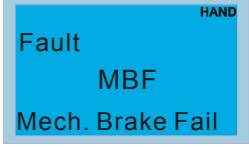
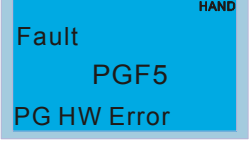
55	cE02	 <p>Fault cE02 Data Addr Err</p>	<p>Illegal data address (00H to 254H)</p> <p>The data address of 0X2XX is between 0X2000~0X2005. Any address not within this range is a fault</p> <p>corrective action</p> <p>Check if the communication address is correct.</p>
56	cE03	 <p>Fault cE03 Data length Err</p>	<p>Illegal data length</p> <p>The data length must be between 1 to 20 digits. Any length out of this range is a fault.</p> <p>corrective action</p> <p>Check if the data length is smaller than the minimum value or over the maximum value.</p>
57	cE04	 <p>Fault cE04 Wrong Writing</p>	<p>Write value to read only communication address</p> <p>Communication addresses such as 0X21XX, 0X22XX are read only. If any command is sent to these addresses, there will be a fault.</p> <p>corrective action</p> <p>Check if the communication address is correct.</p>
58	cE 10	 <p>Fault cE10 Comm Time Out</p>	<p>Modbus communication time-out(Pr09-02~09-03)</p> <p>corrective action</p> <p>Check if the wiring for the communication is correct.</p>
59	cP 10	 <p>Fault cP10 Keypad Time Out</p>	<p>Keypad transmission time-out</p> <p>corrective action</p> <ol style="list-style-type: none"> 1. Check if the wiring for the communication is correct 2. Check if there is any wrong with the keypad
60	bF	 <p>Fault BF Braking Fault</p>	<p>Brake resistor fault</p> <p>corrective action</p> <p>If the fault code is still displayed on the keypad after pressing "RESET" key, return to the factory.</p>
64	7bF	 <p>Fault MBF Mech. Brake Fail</p>	<p>Mechanical brake fail, the feedback signal and the released signal are not consistent.</p> <p>corrective action</p> <ol style="list-style-type: none"> 1. Check if the mechanical brake signal is correct. 2. Check if the detection time setting of mechanical brake (Pr.02-35) is correct.
65	PGF5	 <p>Fault PGF5 PG HW Error</p>	<p>PG card hardware error</p> <p>corrective action</p> <ol style="list-style-type: none"> 1. Check if the wiring of PG feedback is correct. 2. If fault code is still displayed on the keypad with correct PG feedback, please return to the factory.

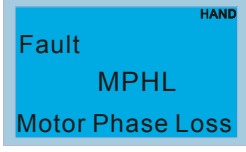
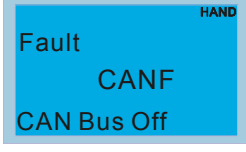
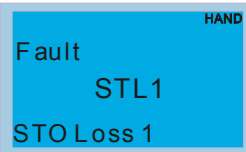
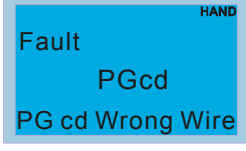
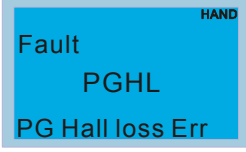
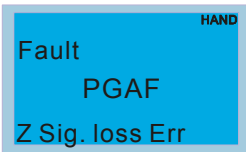
66	MCF		<p>Electromagnetic contactor error, the feedback signal and the released signal are not consistent.</p> <p>corrective action</p> <ol style="list-style-type: none"> 1. Check if the signal of electromagnetic valve is correct. 2. Check if the setting of Pr.02-36 is correct.
67	MPHL		<p>Motor phase loss.</p> <p>corrective action</p> <ol style="list-style-type: none"> 1. Check cabling between drive and motor 2. Check if any output from the motor drive. 3. Return to the factory.
68	CANF		<p>CAN Bus off</p> <p>corrective action</p> <ol style="list-style-type: none"> 1. Check CAN Bus is wired correctly 2. Check PDO communication no time out
69	Reserved		
70	Reserved		
71	Reserved		
72	STL1		<p>STO1~SCM1 internal hardware error detected.</p>
73	PGcd		<p>PG cd wrong wiring</p> <p>corrective action</p> <p>Incorrect wiring for pin C+, C-, D+, D-. Refer to chapter 7-2 for correct wiring.</p>
74	PGHL		<p>PG absolute signal error</p> <p>corrective action</p> <ol style="list-style-type: none"> 1. Check if the encoders absolute positions (C+ C- and D+/D- are properly wired. 2. If the cables are properly wired but the fault code still displays on the keypad, return the motor drive to the factory.
75	PGAF		<p>PG Z phase signal loss</p> <p>corrective action</p> <ol style="list-style-type: none"> 1. Check if the encoder's Z phase signal and PG card are properly wired. 2. If the cables are properly wired but the fault code still displays on the keypad, return the motor drive to the factory.

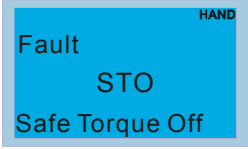
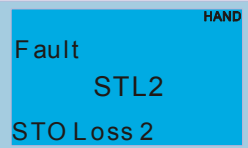
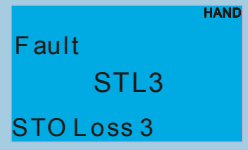
76	StO	 <p>Fault STO Safe Torque Off</p>	Safety Torque Off function is enabled while parameter 06-49 is set to 0 or 2.
77	StL2	 <p>Fault STL2 STO Loss 2</p>	STO2~SCM2 internal hardware error detected.
78	StL3	 <p>Fault STL3 STO Loss 3</p>	STO1~SCM1 and STO2~SCM2 internal hardware error detected.

15 Suggestions & Error Corrections for Standard AC Motor Drives

15-1 Maintenance and Inspections

15-2 Greasy Dirt Problem

15-3 Fiber Dust Problem

15-4 Erosion Problem

15-5 Industrial Dust Problem

15-6 Wiring and Installation Problem

15-7 Multi-function Input/Output Terminals Problem

The AC motor drive has a comprehensive fault diagnostic system that includes several different alarms and fault messages. Once a fault is detected, the corresponding protective functions will be activated. The following faults are displayed as shown on the AC motor drive digital keypad display. The six most recent faults can be read from the digital keypad or communication.

The AC motor drive is made up by numerous components, such as electronic components, including IC, resistor, capacitor, transistor, and cooling fan, relay, etc. These components can't be used permanently. They have limited-life even under normal operation. Preventive maintenance is required to operate this AC motor drive in its optimal condition, and to ensure a long life.

Check your AC motor drive regularly to ensure there are no abnormalities during operation and follows the precautions:



CAUTION

- ☑ Wait 5 seconds after a fault has been cleared before performing reset via keypad of input terminal.
 - ☑ When the power is off after 5 minutes for $\leq 22\text{kW}$ models and 10 minutes for $\geq 30\text{kW}$ models, please confirm that the capacitors have fully discharged by measuring the voltage between + and -. The voltage between + and - should be less than 25VDC.
 - ☑ Only qualified personnel can install, wire and maintain drives. Please take off any metal objects, such as watches and rings, before operation. And only insulated tools are allowed.
 - ☑ Never reassemble internal components or wiring.
 - ☑ Make sure that installation environment comply with regulations without abnormal noise, vibration and smell.
-

15-1 Maintenance and Inspections

Before the check-up, always turn off the AC input power and remove the cover. Wait at least 10 minutes after all display lamps have gone out, and then confirm that the capacitors have fully discharged by measuring the voltage between DC+ and DC-. The voltage between DC+ and DC- should be less than 25VDC.

Ambient environment

Check Items	Methods and Criterion	Maintenance Period		
		Daily	Half Year	One Year
Check the ambient temperature, humidity, vibration and see if there are any dust, gas, oil or water drops	Visual inspection and measurement with equipment with standard specification	<input type="radio"/>		
If there are any dangerous objects	Visual inspection	<input type="radio"/>		

Voltage

Check Items	Methods and Criterion	Maintenance Period		
		Daily	Half Year	One Year
Check if the voltage of main circuit and control circuit is correct	Measure with multimeter with standard specification	<input type="radio"/>		

Digital Keypad Display

Check Items	Methods and Criterion	Maintenance Period		
		Daily	Half Year	One Year
Is the display clear for reading	Visual inspection	<input type="radio"/>		
Any missing characters	Visual inspection	<input type="radio"/>		

Mechanical parts

Check Items	Methods and Criterion	Maintenance Period		
		Daily	Half Year	One Year
If there is any abnormal sound or vibration	Visual and aural inspection		<input type="radio"/>	
If there are any loose screws	Tighten the screws		<input type="radio"/>	
If any part is deformed or damaged	Visual inspection		<input type="radio"/>	
If there is any color change by overheating	Visual inspection		<input type="radio"/>	
If there is any dust or dirt	Visual inspection		<input type="radio"/>	

Main circuit

Check Items	Methods and Criterion	Maintenance Period		
		Daily	Half Year	One Year
If there are any loose or missing screws	Tighten or replace the screw	<input type="radio"/>		
If machine or insulator is deformed, cracked, damaged or with color change due to overheating or ageing	Visual inspection NOTE: Please ignore the color change of copper plate		<input type="radio"/>	
If there is any dust or dirt	Visual inspection		<input type="radio"/>	

Terminals and wiring of main circuit

Check Items	Methods and Criterion	Maintenance Period		
		Daily	Half Year	One Year
If the terminal or the plate is color change or deformation due to overheat	Visual inspection		<input type="radio"/>	
If the insulator of wiring is damaged or color change	Visual inspection		<input type="radio"/>	
If there is any damage	Visual inspection	<input type="radio"/>		

DC capacity of main circuit

Check Items	Methods and Criterion	Maintenance Period		
		Daily	Half Year	One Year
If there is any leak of liquid, color change, crack or deformation	Visual inspection	<input type="radio"/>		
If the safety valve is not removed? If valve is inflated?	Visual inspection	<input type="radio"/>		
Measure static capacity when required		<input type="radio"/>		

Resistor of main circuit

Check Items	Methods and Criterion	Maintenance Period		
		Daily	Half Year	One Year
If there is any peculiar smell or insulator cracks due to overheat	Visual inspection, smell	<input type="radio"/>		
If there is any disconnection	Visual inspection	<input type="radio"/>		
If connection is damaged?	Measure with multimeter with standard specification	<input type="radio"/>		

Transformer and reactor of main circuit

Check Items	Methods and Criterion	Maintenance Period		
		Daily	Half Year	One Year
If there is any abnormal vibration or peculiar smell	Visual, aural inspection and smell	○		

Magnetic contactor and relay of main circuit

Check Items	Methods and Criterion	Maintenance Period		
		Daily	Half Year	One Year
If there are any loose screws	Visual and aural inspection	○		
If the contact works correctly	Visual inspection	○		

Printed circuit board and connector of main circuit

Check Items	Methods and Criterion	Maintenance Period		
		Daily	Half Year	One Year
If there are any loose screws and connectors	Tighten the screws and press the connectors firmly in place.		○	
If there is any peculiar smell and color change	Visual and smell inspection		○	
If there is any crack, damage, deformation or corrosion	Visual inspection		○	
If there is any liquid is leaked or deformation in capacity	Visual inspection		○	

Cooling fan of cooling system

Check Items	Methods and Criterion	Maintenance Period		
		Daily	Half Year	One Year
If there is any abnormal sound or vibration	Visual, aural inspection and turn the fan with hand (turn off the power before operation) to see if it rotates smoothly		○	
If there is any loose screw	Tighten the screw		○	
If there is any color change due to overheat	Change fan		○	

Ventilation channel of cooling system

Check Items	Methods and Criterion	Maintenance Period		
		Daily	Half Year	One Year
If there is any obstruction in the heat sink, air intake or air outlet	Visual inspection		○	

 **NOTE**

Please use the neutral cloth for clean and use dust cleaner to remove dust when necessary.

15-2 Greasy Dirt Problem

Serious greasy dirt problems generally occur in processing industries such as machine tools, punching machines and so on. Please be aware of the possible damages that greasy oil may cause to your drive:

1. Electronic components that silt up with greasy oil may cause the drive to burn out or even explode.
2. Most greasy dirt contains corrosive substances that may damage the drive.

Solution:

Install the AC motor drive in a standard cabinet to keep it away from dirt. Clean and remove greasy dirt regularly to prevent damage of the drive.

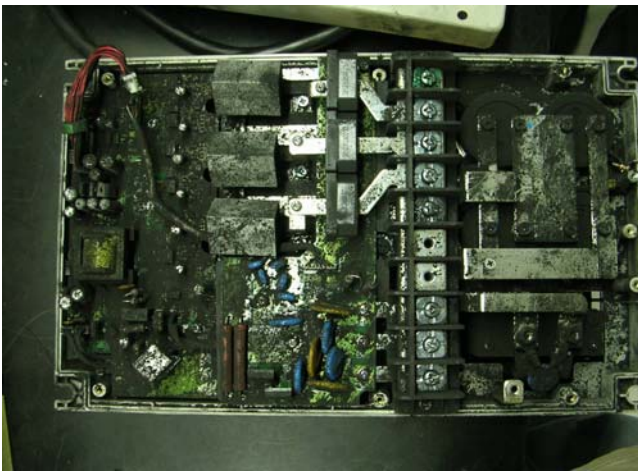

15-3 Fiber Dust Problem

Serious fiber dust problems generally occur in the textile industry. Please be aware of the possible damages that fiber may cause to your drives:

1. Fiber that accumulates or adheres to the fans will lead to poor ventilation and cause overheating problems.
2. Plant environments in the textile industry have higher degrees of humidity that may cause the drive to burn out, become damaged or explode due to wet fiber dust adhering to the devices.

Solution:

Install the AC motor drive in a standard cabinet to keep it away from fiber dust. Clean and remove fiber dust regularly to prevent damage to the drive.

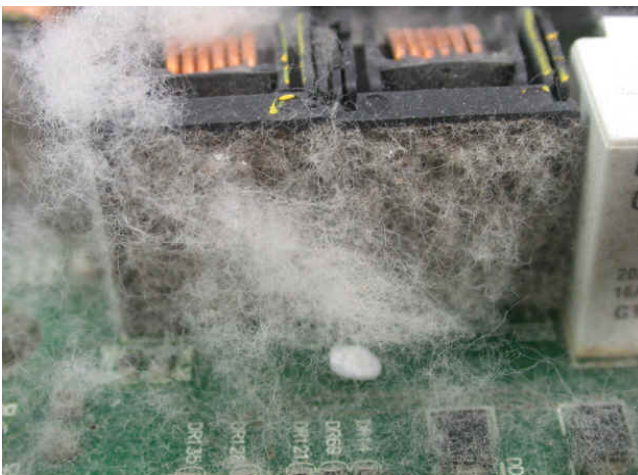

15-4 Erosion Problem

Erosion problems may occur if any fluids flow into the drives. Please be aware of the damages that erosion may cause to your drive.

1. Erosion of internal components may cause the drive to malfunction and possibility to explode.

Solution:

Install the AC motor drive in a standard cabinet to keep it away from fluids. Clean the drive regularly to prevent erosion.

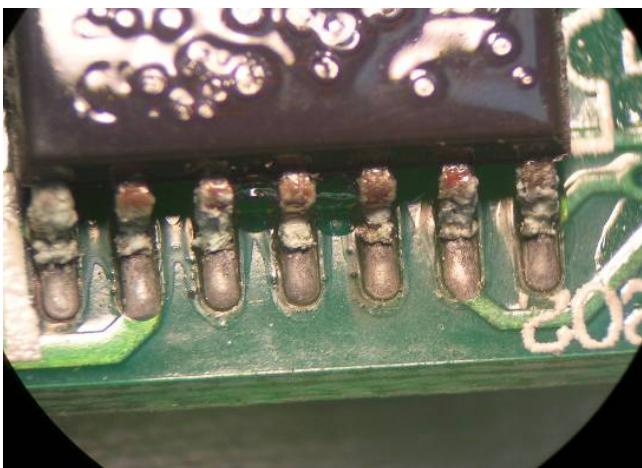
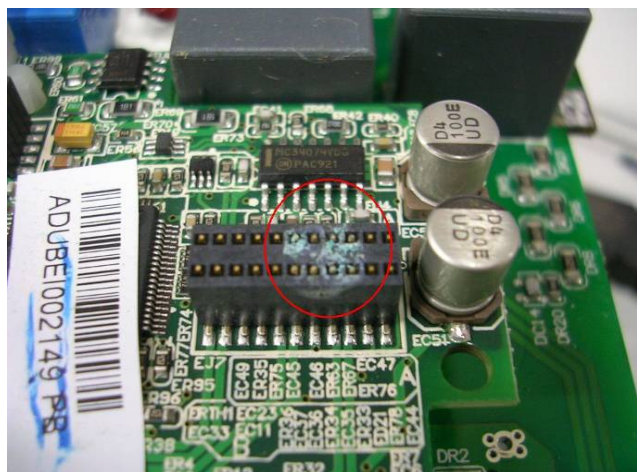
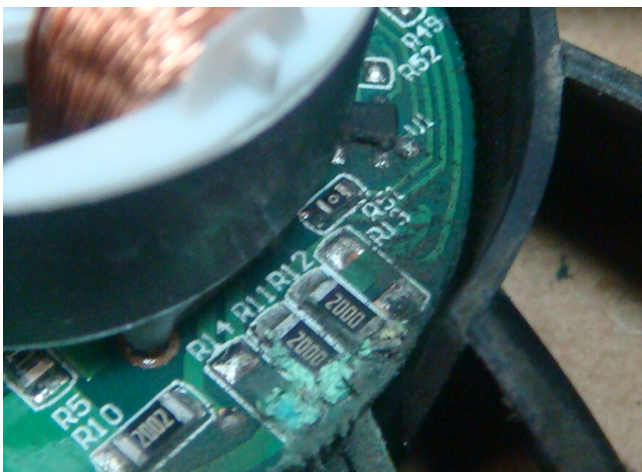

15-5 Industrial Dust Problem

Serious industrial dust pollution frequently occurs in stone processing plants, flour mills, cement plants, and so on. Please be aware of the possible damage that industrial dust may cause to your drives:

1. Dust accumulating on electronic components may cause overheating problem and shorten the service life of the drive.
2. Conductive dust may damage the circuit board and may even cause the drive to explode.

Solution:

Install the AC motor drive in a standard cabinet and cover the drive with a dust cover. Clean the cabinet and ventilation hole regularly for good ventilation.

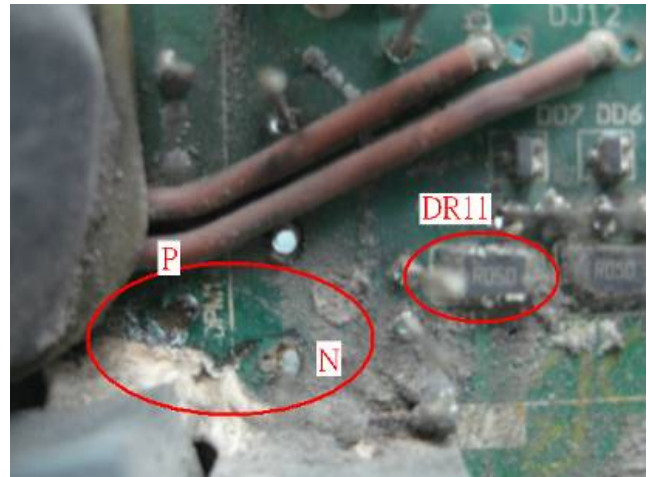
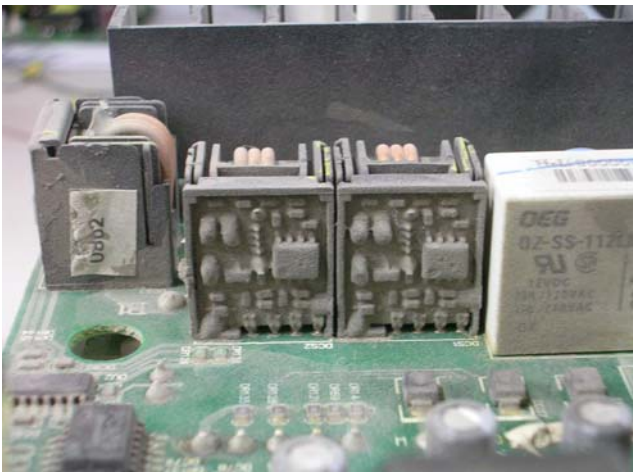

15-6 Wiring and Installation Problem

When wiring the drive, the most common problem is wrong wire installation or poor wiring. Please be aware of the possible damages that poor wiring may cause to your drives:

1. Screws are not fully fastened. Occurrence of sparks as impedance increases.
2. If a customer has opened the drive and modified the internal circuit board, the internal components may have been damaged.

Solution:

Ensure all screws are fastened when installing the AC motor drive. If the AC motor drive functions abnormally, send it back to the repair station. DO NOT try to reassemble the internal components or wire.

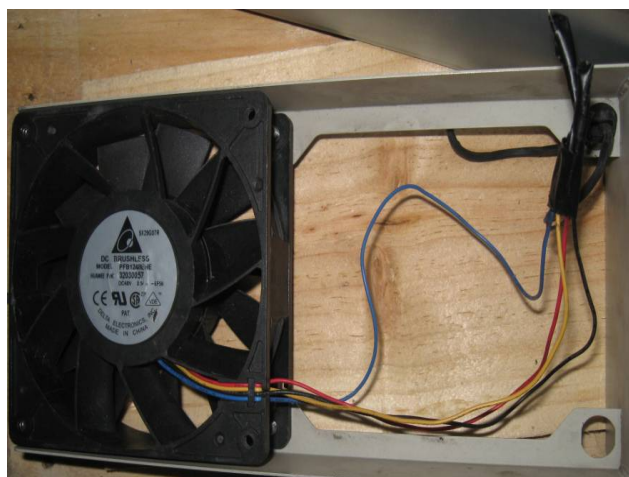

15-7 Multi-function Input/Output Terminals Problem

Multi-function input/output terminal errors are generally caused by over usage of terminals and not following specifications. Please be aware of the possible damages that errors on multi-function input/output terminals may cause to your drives:

1. Input/output circuit may burn out when the terminal usage exceeds its limit.

Solution:

Refer to the user manual for multi-function input output terminals usage and follow the specified voltage and current. DO NOT exceed the specification limits.

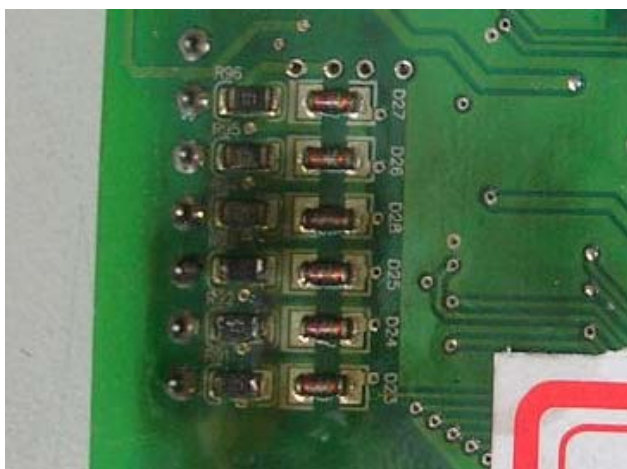
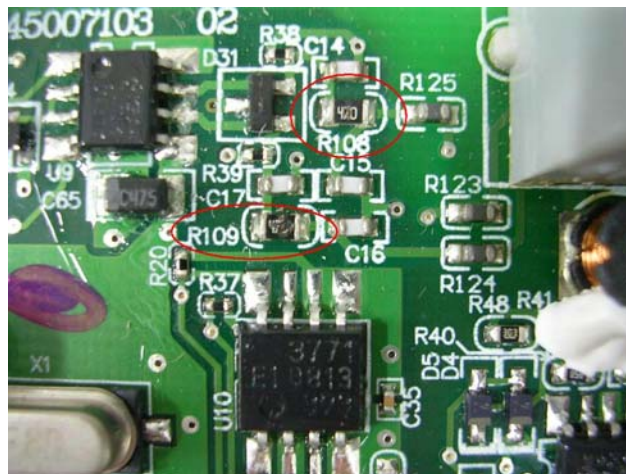
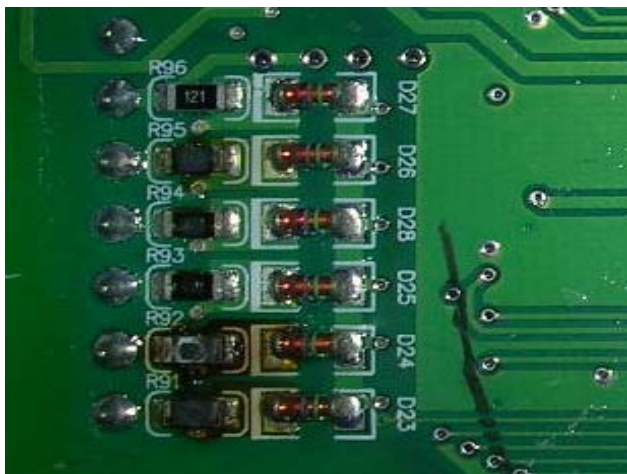

16 Functions of Safety Torque Off*

(*Safety Torque Off = STO)

16-1 Failure Rate of the drive's safety function

16-2 Description of STO's Functions

16-3 Wiring diagrams

16-4 Related Parameters

16-5 Description of Operating Sequence Diagrams

16-6 Error codes related to STO

16-1 Failure Rate of the drive's safety function

Item	Definition	Standard	Performance
SFF	Safe Failure Fraction	IEC61508	Channel 1: 80.08% Channel 2: 68.91%
HFT (Type A subsystem)	Hardware Fault Tolerance	IEC61508	1
SIL	Safety Integrity Level	IEC61508	SIL 2
		IEC62061	SILCL 2
PFH	Average frequency of dangerous failure [h-1]	IEC61508	9.56×10^{-10}
PFD_{av}	Probability of Dangerous Failure on Demand	IEC61508	4.18×10^{-6}
Category	Category	ISO13849-1	Category 3
PL	Performance level	ISO13849-1	d
$MTTF_d$	Mean time to dangerous failure	ISO13849-1	High
DC	Diagnostic coverage	ISO13849-1	Low

16-2 Description of STO's Functions

The purpose of the STO function is to cut off the power supply of the motor to prevent the production of torque force. The STO function is run by two independent hardware to control the drive signals emitted by the motor's current then to cut off motor drive's power module output in order to stop safely the motor drive.

The terminal functions is described in the table below,

Table 1: Description of Terminal Functions

Signal	Channel	Status of Photocoupler			
STO signal	STO1~SCM1	ON(High)	ON(High)	OFF(Low)	OFF(Low)
	STO2~SCM2	ON(High)	OFF(Low)	ON(Low)	OFF(Low)
Driver Output Status		Ready	STL2 mode (Torque output off)	STL1 mode (Torque output off)	STO mode (Torque Output Off)

- STO is Safe Torque Off
- STL1~STL3 means STO hardware abnormal
- STO1~SCM1 ON (High): means STO1~SCM1 has connect to a +24VDC power supply.
- STO2~SCM2 ON (High): means STO2~SCM2 has connect to a +24V power supply.
- STO1~SCM1 OFF (Low): means STO1~SCM1 hasn't connect to a +24VDC power supply.
- STO2~SCM2 OFF (Low): means STO2~SCM2 hasn't connect to a +24VDC power supply.

16-3 Wiring diagrams

16-3-1 Internal Safety Circuit diagram as shown below:

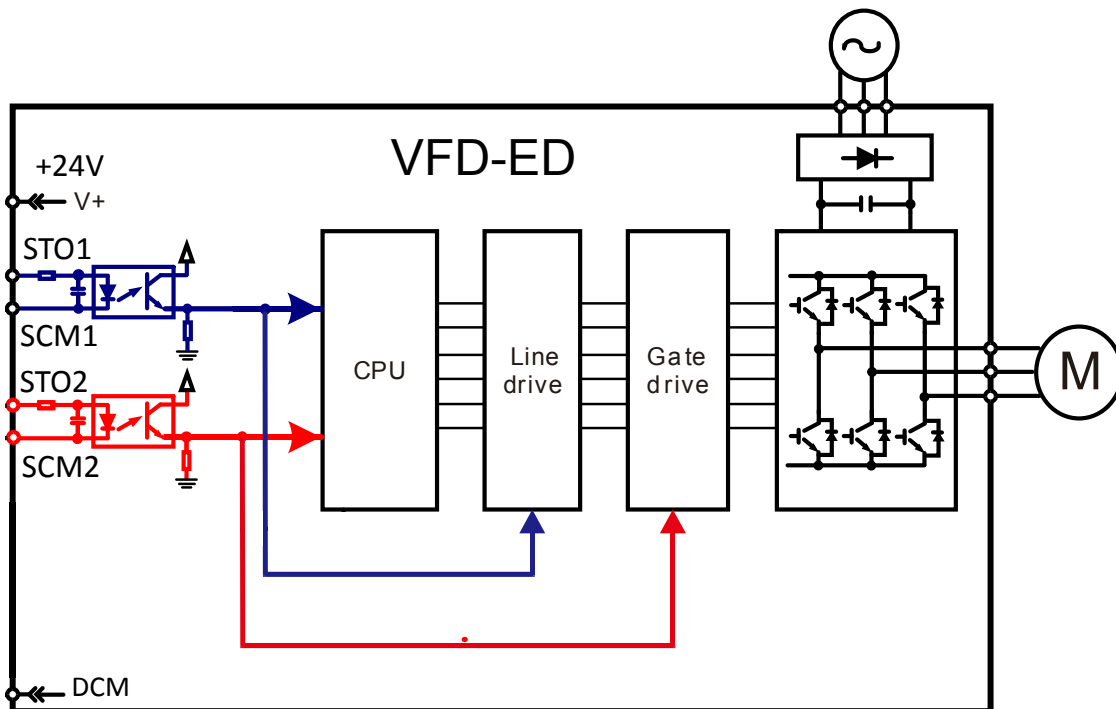

16-3-2 As shown in the diagram D below, the factory setting of terminals +24V-STO1-STO2 and terminals SCM1-SCM2-DCM is short-circuiting.

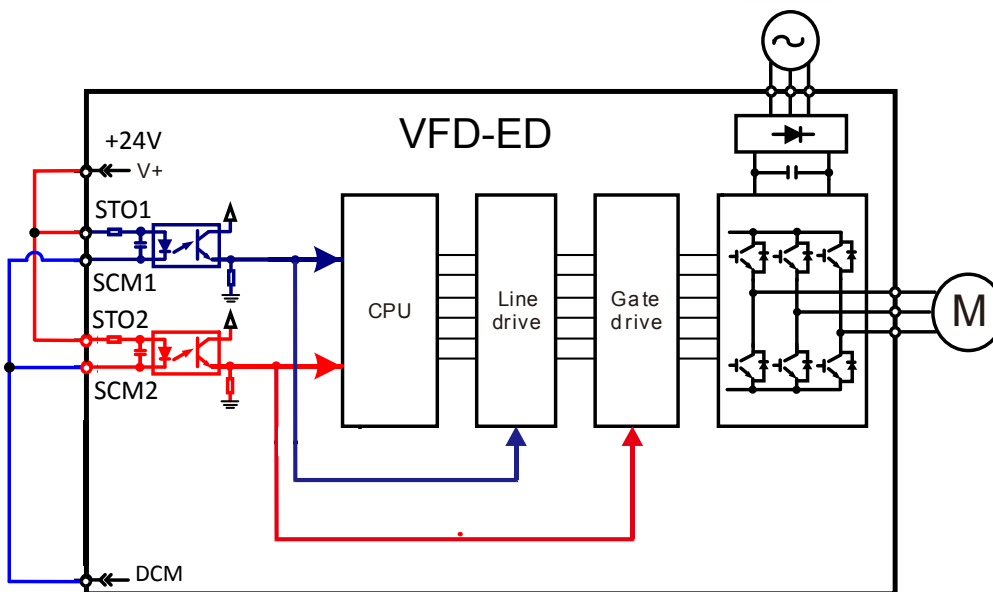
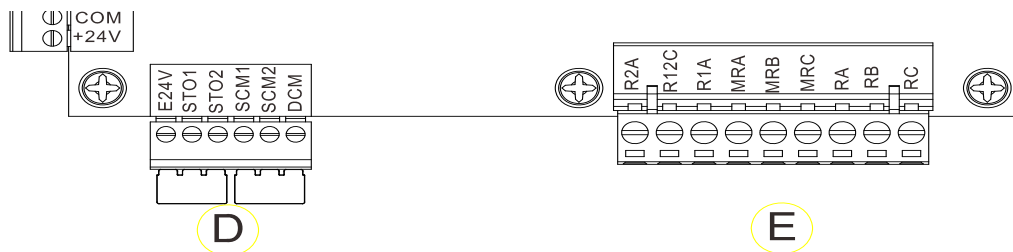

16-3-3 Control Circuit Wiring Diagram

- 1. Remove the short-circuit between E24V-STO1-STO2 and DCM-SCM1-SCM2.
- 2. The wiring diagram is as shown below. The ESTOP must be closed during the normal situation so that the motor drive will be able to run.
- 3. At the STO mode, switch on ESTOP, the motor drive will stop outputting and the keypad panel will display STO.

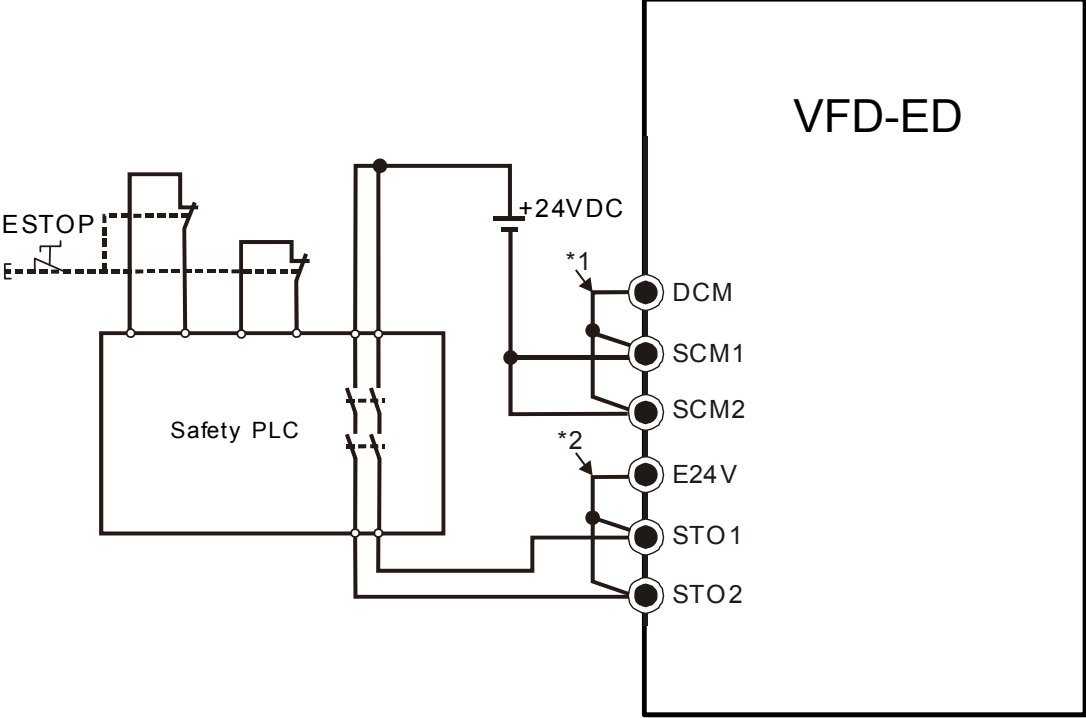

16-4 Related Parameters

↗	06-49	STO Latch Selection				
						Factory Setting: 0
		Setting	0: STO alarm Latch			
			1: STO alarm no Latch			
			2: STO Latch (Warn and record running commands when stop)			
			3: STO No Latch (Warn and record running commands when stop)			

- 📖 When Pr06-49=0, STO alarm is latched which means once the cause of the alarm is cleared, a Reset command is required to clear the STO alarm.
- 📖 When Pr06-49=1, STO alarm is NOT latched which means once the cause of the alarm is cleared, the STO alarm will stop automatically.
- 📖 When in STL1~STL3 mode, STO alarm is latched and Pr06-49 cannot be set.

↗	02-11	Multi-function Output 1 RA, RB, RC (Relay1)				
						Factory Setting: 11
↗	02-12	Multi-function Output 2 MRA, MRC (Relay2)				
						Factory Setting : 1
↗	02-13	Multi-function Output 3 R1A(Relay 3)				
↗	02-14	Multi-function Output 4 R2A(Relay 4)				
↗	02-15	Multi-function Output 5 MO1				
↗	02-16	Multi-function Output 6 MO2				
						Factory Setting : 0
		Settings				
			0: No function			
			1: Operation indication			
			11: Malfunction indication			
			42: STO Output Error			
↗	02-23	Multi-output direction				
						Factory Setting : 0
		This parameter is bit setting. If the bit is 1, the multi-function output terminal will be act with opposite direction.				

Bit 11	Bit 10	Bit 9	Bit 8	Bit 7	Bit 6	Bit 5	Bit 4	Bit 3	Bit 2	Bit 1	Bit 0
-	-	-	-	-	-	MO2	MO1	R2A	R1A	MRA	RA

- 📖 STO Output Error factory setting: Pr02-15(MO1 =42 SO Logic Output A). Set up Pr02-23 <Multi-output direction> to choose Logic Output B.

Status of the Motor Drive	Output status of Safety	
	Logic Output A (02-15=42)	Logic Output B (02-15=42) (02-23=16)
Normal	Broken circuit (Open)	Short circuit (Close)
STO	Short circuit (Close)	Broken circuit (Open)
STL1~STL3	Short circuit Close)	Broken circuit(Open)

16-5 Description of Operating Sequence Diagrams

16-5-1 Normal Operation Status

As shown in Figure 01: When the STO1~SCM1 and STO2~SCM2= ON (safety function is not required), the motor drive will execute "Operating" or "Output Stop" according to the RUN/STOP command.

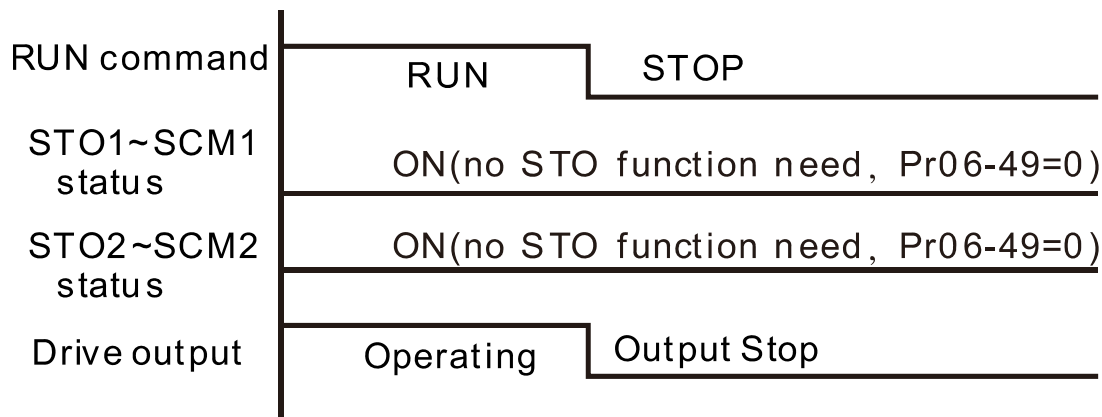

Figure 01

16-5-2 Pr06-49=0, STO alarm Latch

As shown in Figure 02, when both STO1~SCM1 and STO2~SCM2 channels are turned OFF (safety function is required) during operation, the STO function will be enabled and the motor drive will stop output regardless what kind of command is.

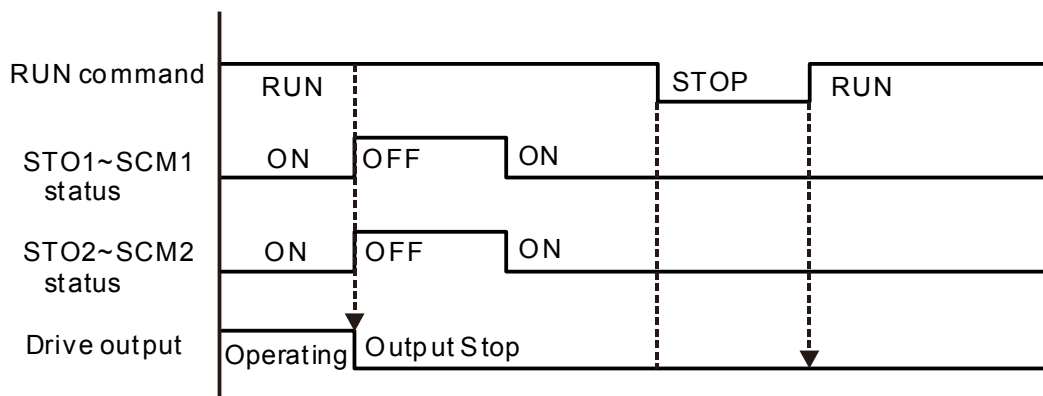

Figure 02

16-5-3 Pr06-49=1, STO alarm no Latch

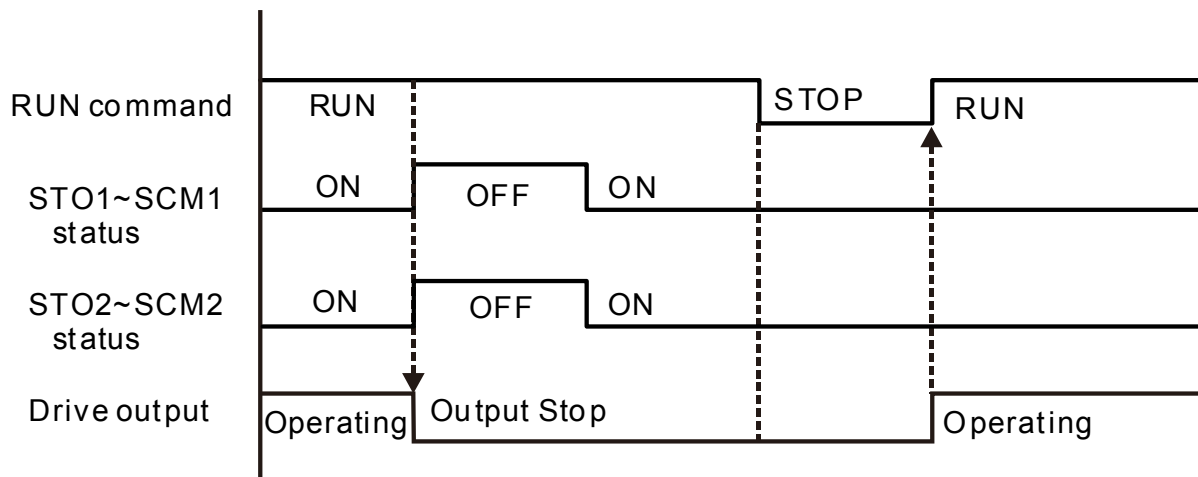

Figure 03

16-5-4 STL1

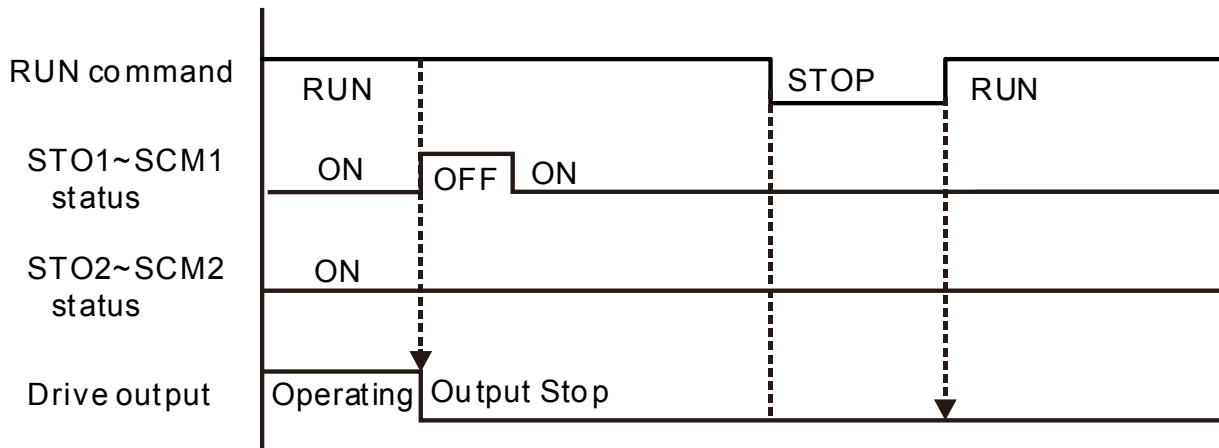

Figure 04

16-5-4 STL2

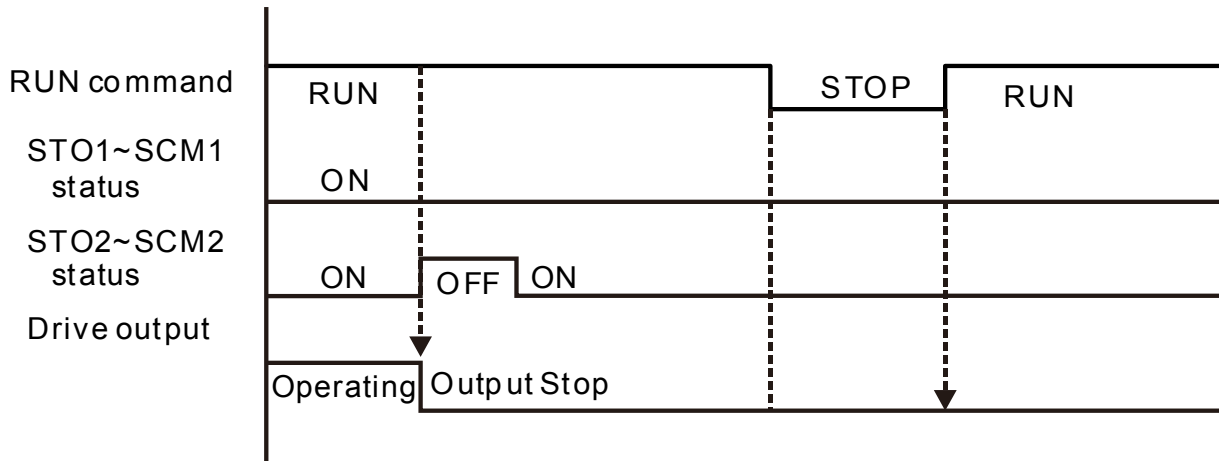

Figure 05

16-6 Fault codes related to STO

06-16	Present Fault Record								
06-17	Second Most Recent Fault Record								
06-18	Third Most Recent Fault Record								
06-19	Fourth Recent Fault Record								
06-20	Fifth Most Recent Fault Record								
06-21	Sixth Most Recent Fault Record								
	Setting								
	72: Safety torque loss (STL1)								
	76: Safety torque output stops(STO)								
	77: Safety torque loss 2 (STL2)								
	78: Safety torque loss 3 (STL3)								

Error Code	Reading	Description
72 (STL1)	Safety Torque Off (STO)	STO1~SCM1 internal hardware error detected.
76 (STO)	Safety torque output stops(STO)	Safety Torque Off function is enabled while parameter 06-49 is set to 0 or 2.
77 (STL2)	Safety torque loss 2 (STL2)	STO2~SCM2 internal hardware error detected.
78 (STL3)	Safety torque loss 3 (STL3)	STO1~SCM1 and STO2~SCM2 internal hardware error detected.

Appendix A:

AC Motor Drives EMC Standard Installation Guide

EMC Compliance Practice

Preface

When an AC motor drive is installed in a noisy environment, radiated and/or conducted noise via signal and power cables can interfere with the correct functioning, cause errors or even damage to the drive. To prevent this, some AC motor drives have an enhanced noise resistance but the results are limited and it is not economical. Therefore, an effective method would be finding the cause of the noise and use the right solution to achieve “no emission, no transmission and no reception of noise”. All three solutions should be applied.

Finding the Noise

- Ascertain whether the error is caused by noise.
- Find the source of the noise and its transmission path.
- Confirm the signal and the source of noise

Solutions

- Grounding
- Shielding
- Filtering

Table of Contents

Preface	i
Table of Contents	ii
Chapter 1 Introduction.....	1
1.1 What is EMC	1
1.2 EMC for AC Motor Drive	1
Chapter 2 How to prevent EMI	2
2.1 Types of EMI: common-mode and differential mode noise	2
2.2 How does EMI transmit? (Noise transmission)	2
Chapter 3 Solution to EMI: Grounding	4
3.1 Protective Grounding & Functional Grounding	4
3.2 Ground Loops	5
3.3 Earthing Systems	5
Chapter 4 Solution to EMI: Shielding	9
4.1 What is Shielding?	9
4.2 How to Reduce EMI by Shielding?	10
Chapter 5 Solution to EMI: Filter	12
5.1 Filter	12
5.2 Harmonic Interference.....	14

Chapter 1 Introduction

1.1 What is EMC?

Electromagnetic Compatibility (EMC) is the ability of an electrical device to function properly in electromagnetic environments. It does not emit electromagnetic noise to surrounding equipment and is immune to interference from surrounding equipment. The goal is to achieve high immunity and low emission; these two properties define the quality of EMC. In general, electrical devices react to high and low frequency phenomena. High frequency phenomena are electrostatic discharge (ESD); pulse interference; radiated electromagnetic field; and conducted high frequency electrical surge. Low frequency phenomena refer to mains power harmonics and imbalance.

The standard emission and immunity levels for compliance depend on the installation location of the drive. A Power Drive System (PDS) is installed in an industrial or domestic environment. A PDS in a domestic environment must have lower emission levels and is allowed to have lower immunity levels. A PDS in an industrial environment is allowed to have higher emission levels but must have more severe immunity levels.

1.2 EMC for AC Motor Drive

When an AC motor drive is put into operation, harmonic signal will occur at the AC drive's power input and output side. It creates a certain level of electromagnetic interference to the surrounding electrical devices and the mains power network. An AC motor drive is usually applied in industrial environments with a strong electromagnetic interference. Under such conditions, an AC drive could disturb or be disturbed.

Delta's AC motor drives are designed for EMC and comply with EMC standard EN61800-3 2004. Installing the AC motor drive accurately will decrease EMI influences and ensure long term stability of the electricity system. It is strongly suggested to follow Delta's user manual for wiring and grounding. If any difficulties or problems arise, please follow the instructions and measures as indicated in this EMC Standard Installation Guide.

Chapter 2 How to prevent EMI

2.1 Types of EMI: Common-mode and differential-mode noise

The electromagnetic noise of an AC motor drive can be distinguished into common-mode and differential-mode noise. Differential-mode noise is caused by the stray capacitance between the conducting wires and common-mode noise is caused by the common-mode coupling current path created by the stray capacitance between the conducting wires and ground.

Basically, differential-mode noise has a greater impact to the AC motor drive and common-mode noise has a greater impact to high-sensitivity electronic devices. An excessive amount of differential-mode noise may trigger the circuit protection system of the AC motor drive. Common-mode noise affects peripheral electronic devices via the common ground connection.

EMC problems can be more serious when the following conditions apply:

- When a large horsepower AC motor drive is connected to a large horsepower motor.
- The AC motor drive's operation voltage increases.
- Fast switching of the IGBTs.
- When a long cable is used to connect the motor to the AC motor drive.

2.2 How does EMI transmit? (Noise transmission path)

Noise disturbs peripheral high-sensitivity electrical devices/systems via conduction and radiation, their transmission paths are shown hereafter:

1. Noise current in the unshielded power cable is conducted to ground via stray capacitances into a common-mode voltage. Whether or not other modules are capable to resist this common-mode noise depends on their Common-Mode Rejection Ratio (CMRR), as shown in the following figure.

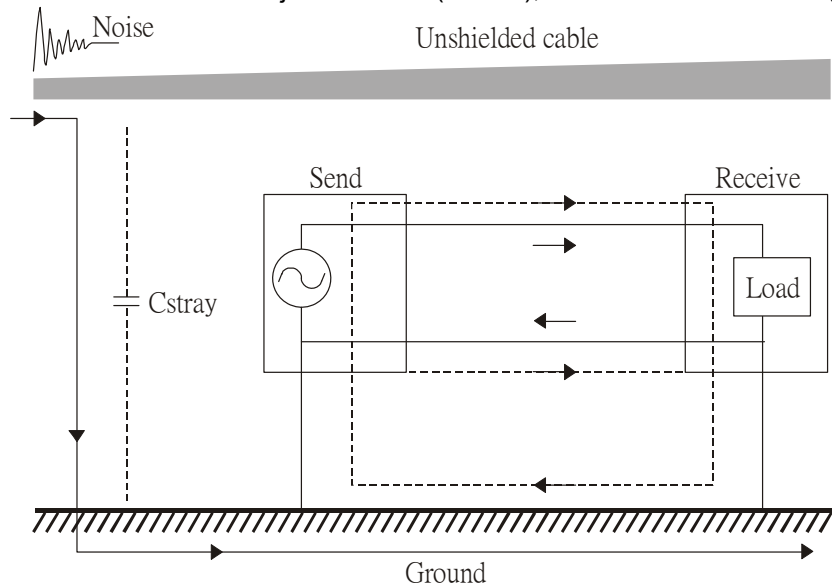

2. Common-mode noise in the power cable is transmitted through the stray capacitance and coupled into the adjacent signal cable, as shown in Figure 2. Several methods can be applied to reduce the effect of this common-mode noise; for example, shield the power cable and/or the signal cables, separate the power and signal cables, take the input and output side of the signal cable and twist them together to balance out the stray capacitance, let power cables and signal cables cross at 90° , etc.

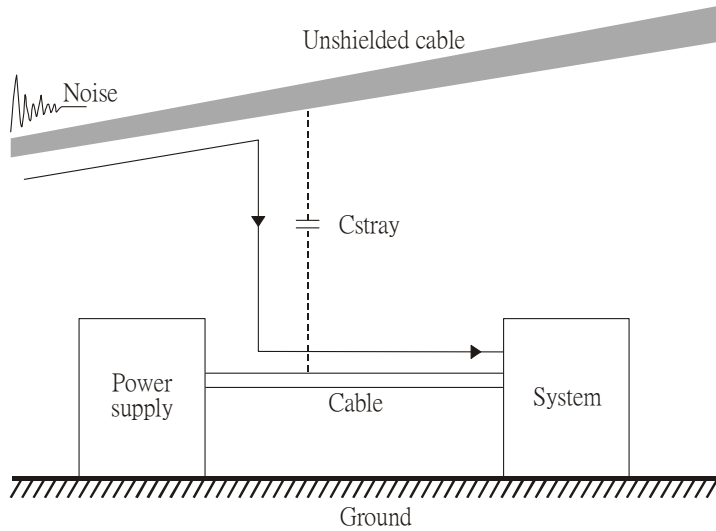

3. Common-mode noise is coupled via the power cable to other power systems then the cable of such a power system is coupled to the transmission system, as shown in Figure 3.

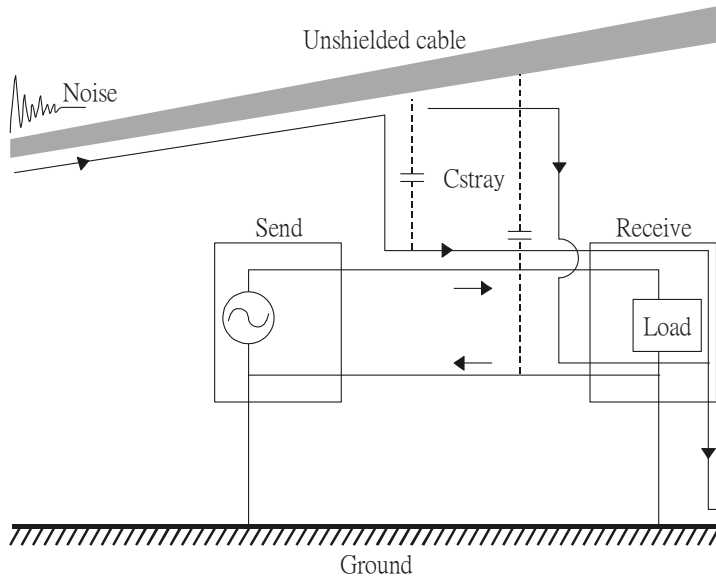

4. The common-mode noise of an unshielded power cable is transmitted to the ground via the stray capacitance. Since both shielded wire and unshielded wire are connected to a common ground, other systems can be interfered with by the common-mode noise that is transmitted from the ground back to the system via the shield. See Figure 4.

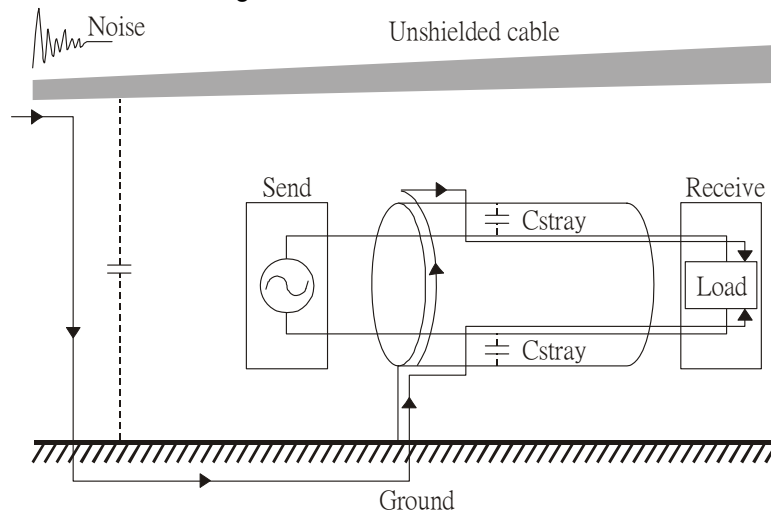

5. When excessive pulse modulated currents pass through an un-grounded AC drive cable, it acts as an antenna and creates radiated interference.

Chapter 3 Solution to EMI: Grounding

The leakage current of an electronic equipment is conducted to ground via the grounding wire and the ground electrode. According to Ohm's law, potential differences may arise when the electrode's ground and the ground's ground resistance are different.

According to Ohm's law, the earth resistance for electrode and the ground are different, in this case potential differences may arise.

3.1 Protective Grounding & Functional Grounding

Please carefully read the following instruction if two types of grounding are applied at the same time.

Protective grounding is applied outside buildings and must have low resistance. On the other hand, functional grounding can be applied inside buildings and must have low impedance.

The goal of EMC is to avoid any interference effects. Grounding for EMC can be distinguished by frequency. For frequencies lower than 10 kHz, a *single-point ground* system should be used and for frequencies higher than 10 kHz, a *multiple point ground* system should be used.

- *Single Point Grounding*: all signal grounds of all IT equipment are connected in series to form a single reference point. This point can be grounded directly to earth; to the designated grounding point or to the safety point that is already grounded.
- *Multiple Point Grounding*: all signals of all IT equipment are grounded independently.
- *Hybrid Grounding*: this type of grounding behaves differently for low and high frequencies. When two pieces of IT equipment (A and B) are connected via a shielded cable, one end is connected directly to ground while the other end is connected to ground via a capacitor. This type of grounding system fulfils the criteria for high and low frequency grounding.
- *Floating grounding*: the signals of all IT equipment are isolated from each other and are not grounded.

DC current flows evenly throughout the conductor section. But AC current flows towards the conductor's surface as frequency increases; this is called the "skin effect". It causes the effective cross-section area to be reduced with increasing frequency. Therefore it is suggested to increase the effective ground cross-section area for high frequencies by replacing pigtail grounding by braided conductors or strip conductors. Refer to the following figure.

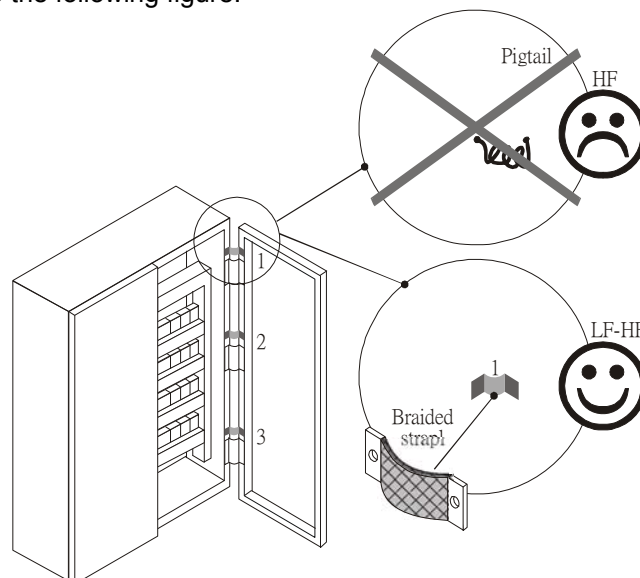

This is why a thick short ground wire must be implemented for connecting to the common grounding path or the ground busbar. Especially when a controller (e.g. PLC) is connected to an AC motor drive, it must be grounded by a short and thick conducting wire. It is suggested to use a flat braided conductor (ex: metal mesh) with a lower impedance at high frequencies.

If the grounding wire is too long, its inductance may interfere structure of the building or the control cabinet and form mutual inductance and stray capacitance. As shown in the following figure, a long grounding wire could become a vertical antenna and turn into a source of noise.

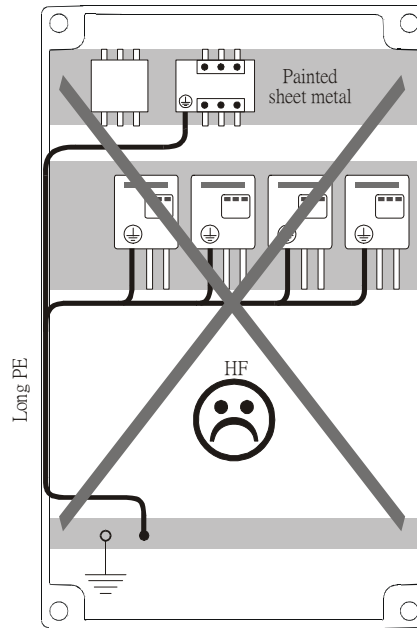

3.2 Ground Loops

A *ground loop* occurs when the pieces of equipment are connected to more than one grounding path. In this case, the ground current may return to the grounding electrode via more than one path. There are three methods to prevent ground loops

1. Use a common power circuit
2. Single point grounding
3. Isolate signals, e.g. by photocouplers

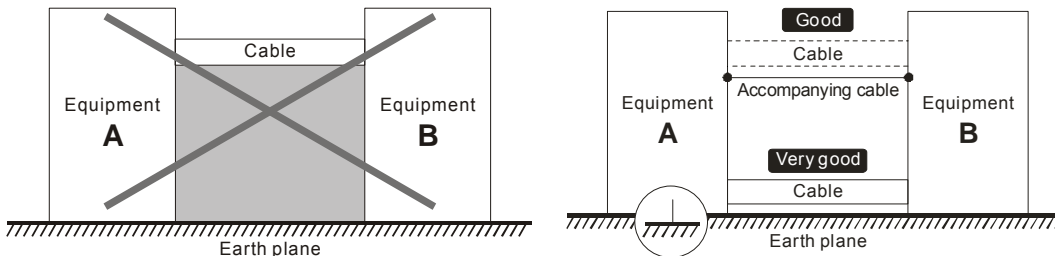

In order to avoid “Common Mode Noise”, please use parallel wires or twisted pair wiring. Follow this rule and also avoid long wires, it is suggested to place the two wires as close to each other as possible.

3.3 Earthing Systems

The international standard IEC60364 distinguishes three different earthing system categories, using the two-letter codes TN, TT, IT.

- The **first letter** indicates the type of earthing for the power supply equipment (generator or transformer).
 - T**: One or more points of the power supply equipment are connected directly to the same earthing point.
 - I**: Either no point is connected to earth (isolated) or it is connected to earth via high impedance.
- The **second letter** indicates the connection between earth and the power supply equipment.
 - T**: Connected directly to earth (This earthing point is separate from other earthing points in the power supply system.)
 - N**: Connected to earth via the conductor that is provided by the power supply system
- The **third and fourth letter** indicate the location of the earth conductor.
 - S**: Neutral and earth conductors are separate
 - C**: Neutral and earth are combined into a single conductor

TN system

TN: The neutral point of the low voltage transformer or generator is earthed, usually the star point in a three-phase system. The body of the electrical device is connected to earth via this earth connection at the transformer.

protective earth (PE): The conductor that connects the exposed metallic parts of the consumer.

neutral (N): The conductor that connects to the start point in a 3-phase system or that carries the return current in a single phase system.

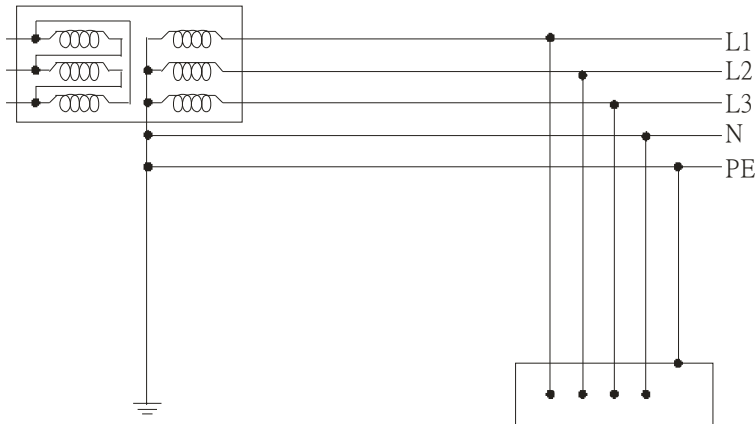

TN-S system

TN-S: PE and N are two separate conductors that are combined together only near the power source (transformer or generator). It is the same as a three-phase 5-wire system.

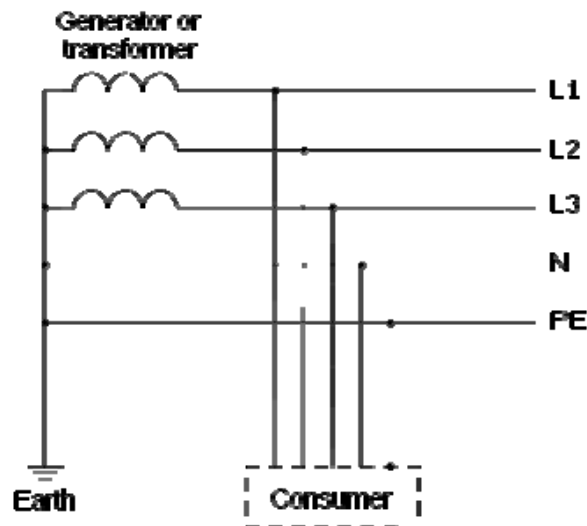

TN-C system

TN-C: PE and N are two separate conductors in an electrical installation similar to a three-phase 5 wire system, but near the power side, PE and N are combined into a PEN conductor similar to a three-phase 4 wire system.

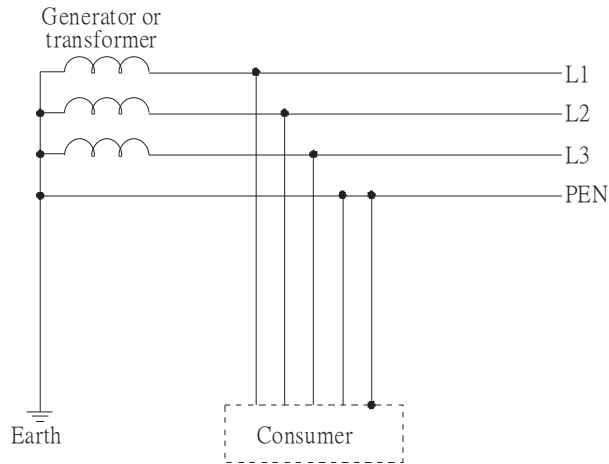

TN-C-S system

TN-C-S: A combined earth and neutral system (PEN conductor) is used in certain systems but eventually split up into two separate conductors PE and N. A typical application of combined PEN conductor is from the substation to the building but within the building PEN is separated into the PE and N conductors. Direct connection of PE and N conductors to many earthing points at different locations in the field will reduce the risk of broken neutrals. Therefore this application is also known as *protective multiple earthing (PME)* in the UK or as *multiple earthed neutral (MEN)* in Australia

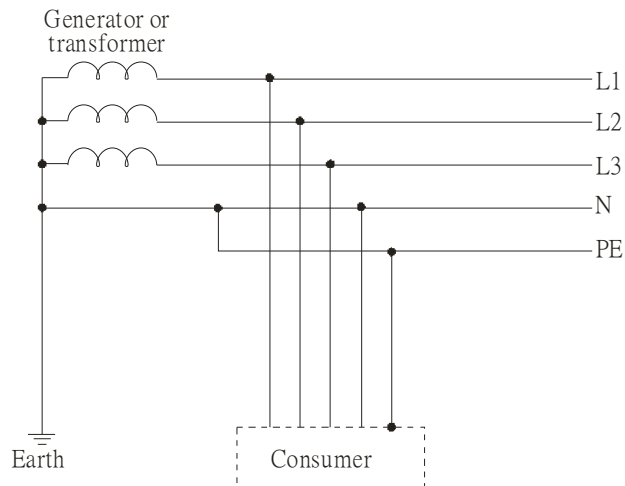

TT system

TT: The neutral point (N) of the low voltage transformer and the equipment frames (PE) are connected to a separate earthing point. The Neutral (N) of the transformer and electrical equipment are connected.

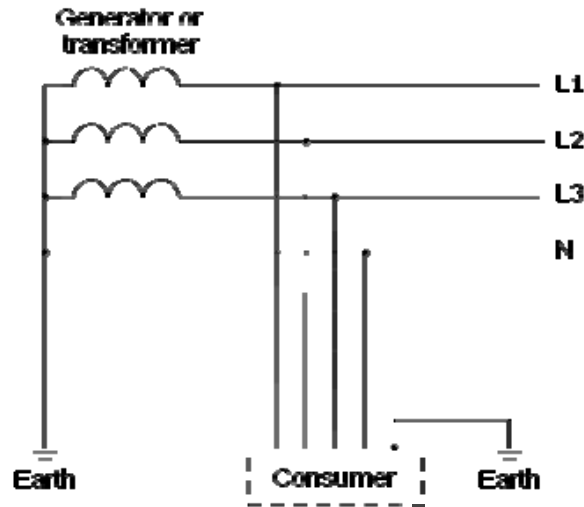

IT system

IT: The neutral point of the transformer and electrical equipment are not earthed, only the equipment frames PE are earthed.

In the IT network, the power distribution system Neutral is either not connected to earth or is earthed via high impedance. In such a system, an insulated monitoring device is used for impedance monitoring. A built-in filter should be disconnected by the RFI-jumper and an external filter should not be installed

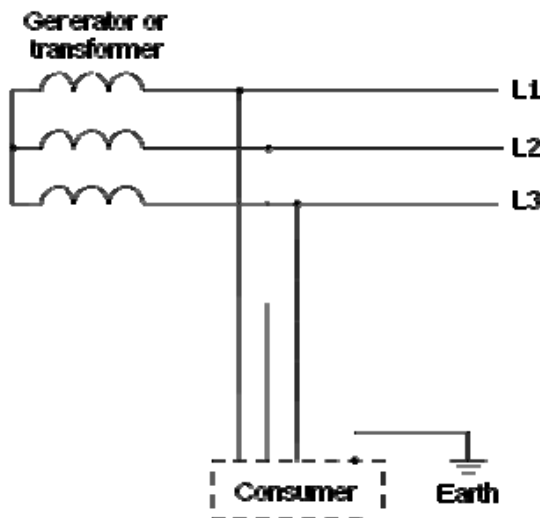

when the AC motor drive or the AC servo motor drive is connected to an IT system.

Criteria for earthing system and EMC

	TN-S	TN-C	TT	IT
Safety of Personnel	Good	Good	Good	Good
	Continuity of the PE conductor must be ensured throughout the installation	Continuity of the PE conductor must be ensured throughout the installation	RCD is mandatory	Continuity of the PE conductor must be ensured throughout the installation

Safety of property	Poor High fault current (around 1kA)	Poor High fault current (around 1kA)	Good Medium fault current (< a few dozen amperes)	Good Low current at the first fault (< a few dozen mA) but high current at the second fault
Availability of energy	Good	Good	Good	Excellent
EMC behavior	Excellent Few equipotential Problems: - Need to handle the high leaking currents problem of the device - High fault current (transient disturbances)	Poor (prohibited) - Neutral and PE are the same - Circulation of disturbance currents in exposed conductive parts (high magnetic-field radiation) - High fault currents (transient disturbances)	Good - Over-voltage risk - Equipotential Problems: - Need to handle the high leaking currents problem of the device - RCD (Residual-current device)	Poor (should be avoided) - Over-voltage risk - Common-mode filters and surge arrestors must handle the phase to phase voltage. - RCDs subject to nuisance tripping when common-mode capacitors are present - Equivalent to TN system for second fault

Chapter 4 Solution to EMI: Shielding

4.1 What is Shielding?

Electrostatic shielding is used to isolate equipment so that it will not create electromagnetic field interference or be influenced by an external electromagnetic field. A conductive material is used for electrostatic shielding to achieve this isolation.

A *Faraday cage* can be made from a mesh of metal or a conductive material. One characteristic of metal is that it is highly conductive and not electrostatic, which offers shielding and prevents interference by external electrical fields. Metal with its high conductivity protects the internal devices from high voltages—no voltage will enter the cage even when the cage is experiencing a high current. In addition, electromagnetic fields can also pass through the Faraday cage without causing any disturbance.

Electromagnetic shielding is applied to some electrical devices and measurement equipment for the purpose of blocking interference. Examples of shielding include:

- earth high-voltage indoor equipment using a metal frame or a high-density metal mesh
- shielding a power transformer is achieved by wrapping a metal sheet between the primary and secondary windings or by adding an enamel wire to the winding wire which is then earthed.
- a shielding coating, which is made of metal mesh or conductive fibers to provide effective protection for the workers who work in a high-voltage environment.

In the picture below, the radio appears to be not fully covered by metal but if the conductivity of the metal is high, radio waves are completely blocked and the radio will not receive any signal.

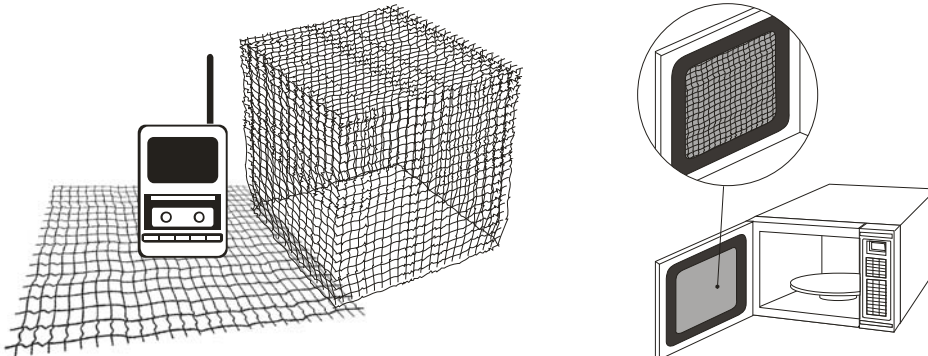

Mobile phone connections are also established through the transmission of radio waves. This is why the mobile phone reception is often cut off when we walk into an elevator. The metal walls of the elevator create the same shielding effect just as if we had entered a metal cage. Another example is a microwave oven. The microwave door may seem transparent in visible light, but the density of the metal mesh in the microwave door blocks the electromagnetic waves. A higher density of the metal mesh offers better shielding.

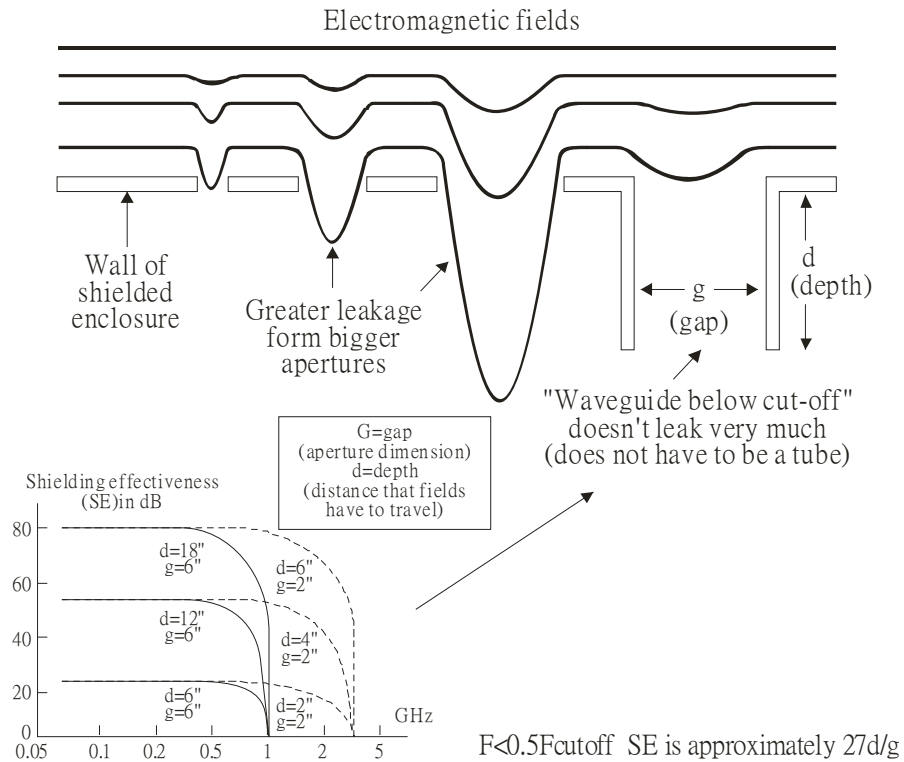

4.2 How to reduce EMI by Shielding?

Iron and other metals are high conductivity materials that provide effective shielding at extremely low frequencies. But conductivity will decrease as:

1. High frequency signals are applied to the conductor.
2. Equipment is located in a strong magnetic field
3. The shielding frame is forced into a specific form by machines.

It is difficult to select a suitable high-conductivity material for shielding without the help from a shielding material supplier or a related EMI institution.

Metallic Shielding Effectiveness

Shielding Effectiveness (SE) is used to assess the applicability of the shielding shell. The formula is:

$$SE_{dB} = A + R + B \quad (\text{Measures in dB})$$

where

- A = Absorption loss (dB)
- R = Reflection loss (dB)
- B = Correction factor (dB) (for multiple reflections in thin shields)

The absorption loss refers to the amount of energy loss as the electromagnetic wave travels through the shield. The formula is:

$$AdB = 1.314(f\sigma\mu)^{1/2}t$$

where

- f = frequency (MHz)
- μ = permeability relative to copper
- σ = conductivity relative to copper
- t = thickness of the shield in centimeters

The reflection loss depends on the source of the electromagnetic wave and the distance from that source. For a rod or straight wire antenna, the wave impedance increases as it moves closer to the source and decreases as it moves away from the source until it reaches the plane wave impedance (377) and shows no change. If the wave source is a small wire loop, the magnetic field is dominant and the wave impedance decreases as it moves closer to the source and increases as it moves away from the source; but it levels out at 377 when the distance exceeds one-sixth of the wavelength.

Electrical Cabinet Design

In a high frequency electric field, shielding can be achieved by painting a thin layer of conductive metal on the enclosure or on the internal lining material. However, the coating must be thorough and all parts should be properly covered without any seams or gaps (just like a Faraday cage). That is only the ideal. Making a seamless shielding shell is practically impossible since the cage is composed of metal parts. In some conditions, it is necessary to drill holes in the shielding enclosure for installation of accessories (like optional cards and other devices).

1. If the metallic components are properly welded using sophisticated welding technology to form an electrical cabinet, deformation during usage is unlikely to occur. But if the electrical cabinet is assembled with screws, the protective insulating layer under the screw must be properly removed before assembly to achieve the greatest conductivity and best shielding.
2. Drilling holes for the installation of wires in the electrical cabinet lowers the shielding effectiveness and increases the chance of electric waves leaking through the openings and emitting interference. We recommend that the drilled holes are as narrow as possible. When the wiring holes are not used, properly cover the holes with metal plates or metal covers. The paint or the coating of the metal plate and metal cover should be thoroughly removed to ensure a metal-to-metal contact or a conductive gasket should be installed.
3. Install industrial conductive gaskets to completely seal the electrical cabinet and the cabinet door without gaps. If conductive gaskets are too costly, please screw the cabinet door to the electrical cabinet with a short distance between the screws.
4. Reserve a grounding terminal on the electrical cabinet door. This grounding terminal shall not be painted. If the paint already exists, please remove the paint before grounding.

Electrical wires and cables

Shielded Twisted Pair (STP) is a type of cable where two insulated copper wires are twisted together with a metal mesh surrounding the twisted pair that forms the electromagnetic shielding and can also be used for grounding.

The individual electrical wires and complete cable are surrounded by (synthetic) rubber that provides insulation and also protects against damage.

There are two types of electrical cables: high voltage and low voltage. The high voltage cable differs from the low voltage cable in that it has an additional insulation layer called the dielectric insulator within the plastic sleeve. The dielectric insulator is the most important component in insulation. The low voltage cable is usually only filled with a soft polymer material for keeping the internal copper wire in place.

The shield has two functions.

1. To shield the electrical wire and cable.
 - A. Electric currents increase as power flows through the power cable and generate an electrical field. Such interference can be suppressed inside the cable by shielding the power cables or the electrical wires.
 - B. To form a protective earthing. When the cable core is damaged, the leakage current will flow via the shield to ground
2. To protect the cable. A power cable used for the computer control purpose generates only relatively low amount of current inside the cable. Such power cable will not become the source of interferences but has great possibility to be interfered by the surrounding electrical devices.

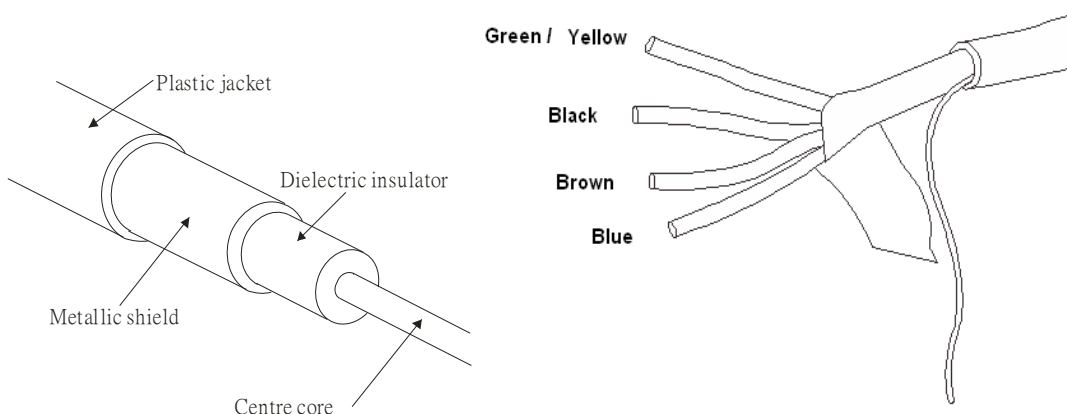

Chapter 5 Solution to EMI: Filter

5.1 Filter

Electromagnetic interference is transmitted in two ways, by radiation and by conduction. The most effective and economical method of reducing radiated interference is to use shielding and of reducing conducted interference is to use an electromagnetic filter.

Noise interference can be divided into two categories: high frequency (150kHz~300MHz) and low frequency (100Hz~3000Hz). High-frequency noise fades more over distance and has a shorter wave-length, while low-frequency noise fades less over distance and has a longer wave-length. Both types of interference are transmitted through power cables and power leads, affecting the power supply side.

High-frequency interference at the power side can be eliminated or attenuated by mounting a filter. The filter consists of coils and capacitors. Some drives do not have a built-in filter, in which case the installation of an external option filter is required. The drawing below shows a standard filter diagram:

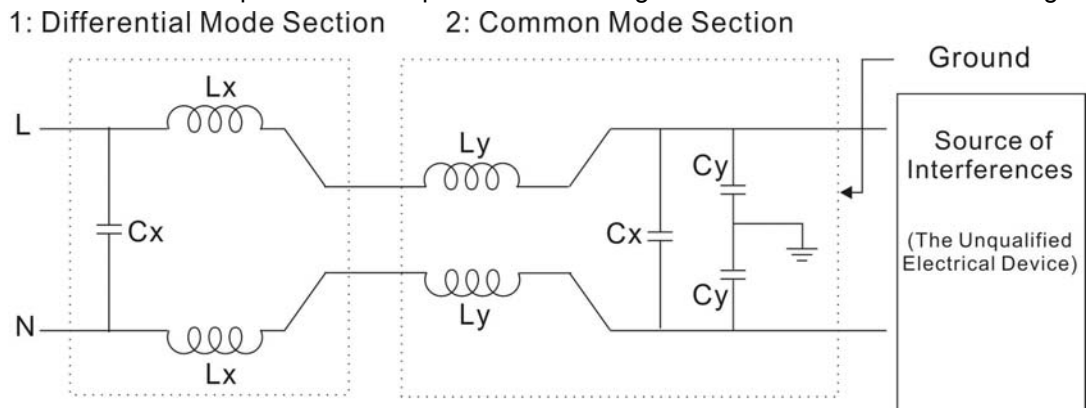

A filter is composed of a Differential Mode section (to eliminate noise below 150 kHz) and a Common Mode section (to eliminate noise above 150 kHz). For high-frequency noise, the inductor acts as a high impedance to form an open circuit and the capacitor acts as a low impedance to form a short circuit. Proper design and dimensioning of inductors and capacitors give a resonant circuit to absorb harmonic currents. Capacitor Cy is earthed to lead the harmonic currents to the ground.

External Filter

The filter and the AC drive should be installed in the control cabinet or on the mounting plate that is earthed to ground. The motor cable must be shielded and as short as possible. Please use the filters recommended by Delta to ensure compliance with EMC standards.

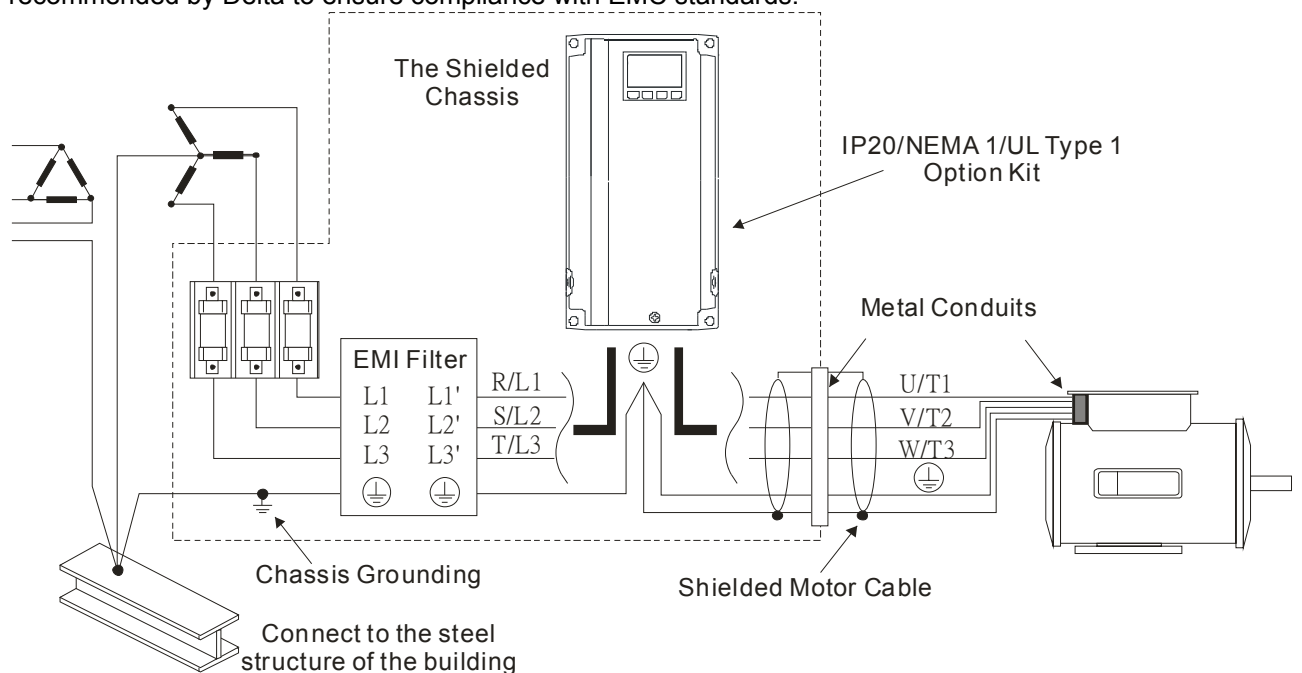

AC Motor Drives with Built-in Filter

1. Since interferences are suppressed by installing an earthed capacitor in the filter, the amount of current to ground (leakage current) could result in electric shocks to personnel or the power system. Please be aware of this problem.
2. Since the leakage current to ground can be high, it is crucial to implement protective earthing to prevent electrical shocks.

Filter Installation (With and Without)

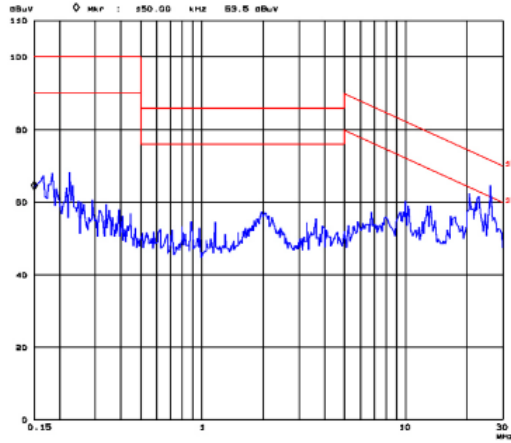

<15m@60Hz with EMI Filter>

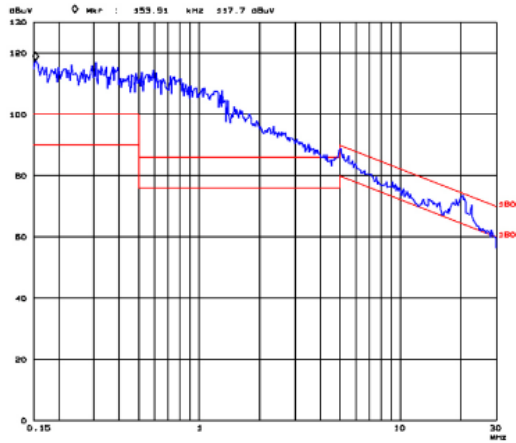

<15m@60Hz without EMI Filter>

Zero Phase Reactor (Choke)

Interferences can also be suppressed by installing a zero phase reactor at the power supply side and/or the AC Motor Drive's output, depending on where the interference is. Since currents are large at the power input and the AC Motor Drive's output, please carefully select the magnetic core with suitable current handling capability. An ideal magnetic material for large currents is compound magnetic powder. It has a higher current handling capability and higher impedance compared to pure metallic magnetic cores. It is therefore suitable to implement in a high frequency environment. The impedance can also be enhanced by increasing the turn ratio.

Zero Phase Reactor Installation

There are two installation methods, depending on the size of the zero phase reactor and the motor cable length.

1. Wind the motor cable through the middle of a zero-phase reactor 4 times. Place the reactor and the AC Motor Drive as close to each other as possible.

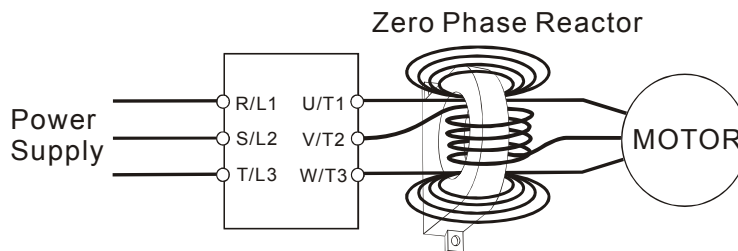

2. Place all wires through the middle of four zero-phase reactors without winding.

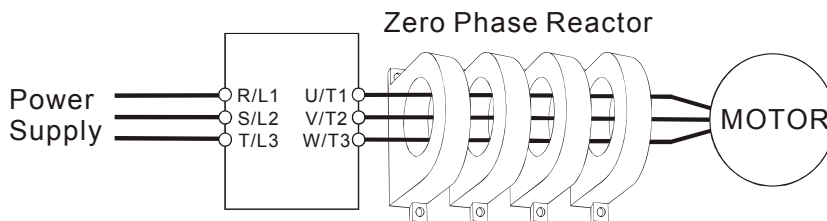

Analog Input Signals

If the analog input signals are affected by noise from the AC motor drive, please connect a capacitor and a ferrite core as indicated in the following diagram. Wind the wires around the core in same direction for 3 times or more.

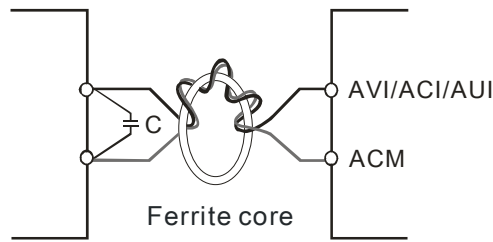

5.2 Harmonic Interference

The AC motor drive's input current is non-linear, the input rectifier generates harmonics. Harmonics must be limited to within a certain range to avoid impact the mains power and to avoid current distortion to ensure surrounding devices are not influenced. An AC Motor Drive with built-in DC reactor suppresses harmonic currents (Total Harmonic Current Distortion THID) effectively and therefore reduces the harmonic voltage peaks (Total Harmonic Voltage Distortion).

Harmonic Current at the Power Supply Side

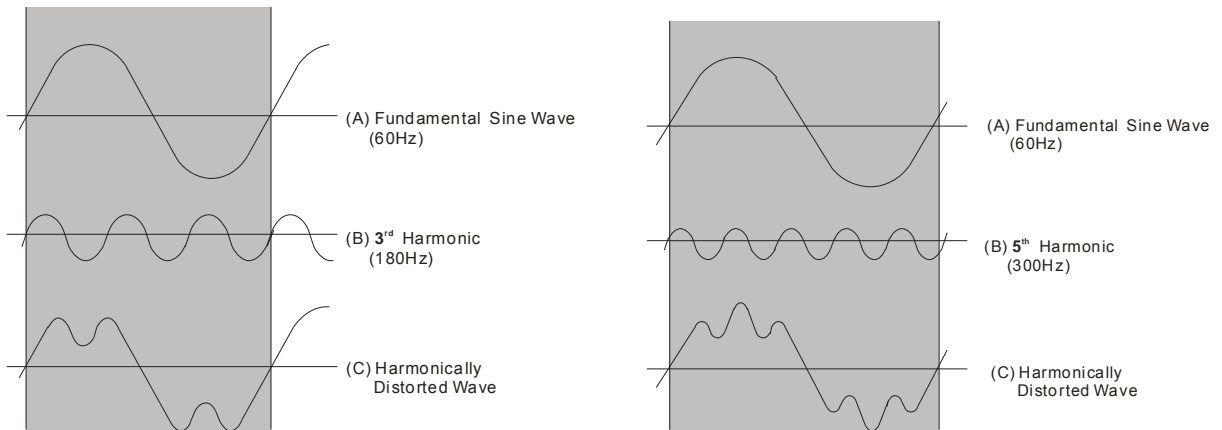

Suppression of Harmonic Currents

When a large portion of lower order harmonic currents (5th, 7th, 11th etc) occur at the power input, surrounding devices will be disturbed and the power factor will be low as a result of reactive power. Installing a reactor at the AC Motor Drive's input effectively suppresses lower order harmonic currents.

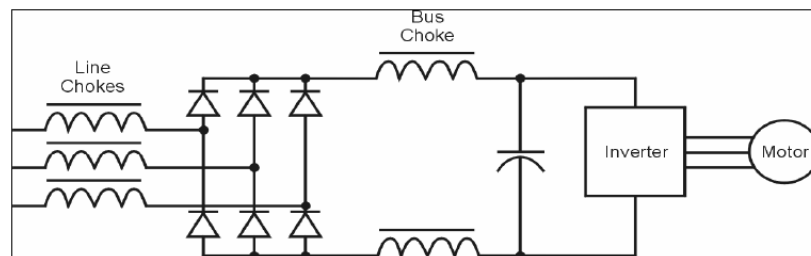

AC Reactor

Installed in series with the power supply and is effective in reducing low order current harmonics. Features of an AC reactor include:

1. Reduces the harmonic currents to the AC Motor Drive and increases the impedance of the power supply.
2. Absorbs interferences generated by surrounding devices (such as surge voltages, currents, and mains surge voltages) and reduce their effect on the AC Motor Drive.
3. Increases the power factor.

DC Reactor

A DC-Reactor is installed between the rectifier and the DC-bus capacitor to suppress harmonic currents and to achieve a higher power factor.

Current Wave Diagrams

