

L-L

VFD-L-L

User Manual

Specific Drive for Wire Drawing Machinery



Power Range:
1-phase 460V series: 200W(0.25HP)



DELTA ELECTRONICS, INC.

www.delta.com.tw/industrialautomation

IABU Headquarters

Delta Electronics, Inc.

Taoyuan1

31-1, Xingbang Road, Guishan Industrial Zone,
Taoyuan County 33370, Taiwan, R.O.C.
TEL: 886-3-362-6301 / FAX: 886-3-362-7267

ASIA

Delta Electronics (Jiang Su) Ltd.

Wujiang Plant3

1688 Jiangxing East Road,
Wujiang Economy Development Zone,
Wujiang City, Jiang Su Province,
People's Republic of China (Post code: 215200)
TEL: 86-512-6340-3008 / FAX: 86-512-6340-7290

Delta Greentech (China) Co., Ltd.

238 Min-Xia Road, Cao-Lu Industry Zone, Pudong, Shanghai,
People's Republic of China
Post code : 201209
TEL: 021-58635678 / FAX: 021-58630003

Delta Electronics (Japan), Inc.

Tokyo Office

Delta Shibadaimon Building, 2-1-14
Shibadaimon, Minato-Ku, Tokyo, 105-0012,
Japan
TEL: 81-3-5733-1111 / FAX: 81-3-5733-1211

Delta Electronics (Korea), Inc.

234-9, Duck Soo Building 7F, Nonhyun-Dong,
Kangnam-Gu, Seoul, Korea 135-010
TEL: 82-2-515-5305 / FAX: 82-2-515-5302

Delta Electronics (Singapore) Pte. Ltd.

8 Kaki Bukit Road 2, #04-18 Ruby Warehouse Complex,
Singapore 417841
TEL: 65-6747-5155 / FAX: 65-6744-9228

Delta Power Solutions (India) Pte. Ltd.

Plot No. 28, Sector-34, EHTP
Gurgaon-122001 Haryana, India
TEL: 91-124-416-9040 / FAX: 91-124-403-6045

AMERICA

Delta Products Corporation (USA)

Raleigh Office

P.O. Box 12173, 5101 Davis Drive,
Research Triangle Park, NC 27709, U.S.A.
TEL: 1-919-767-3813 / FAX: 1-919-767-3969

Delta Products Corporation (Brazil)

Sao Paulo Office

Rua Jardim Ivone, 17 Cjs 13/14-Paraiso
04105-020-Sao Paulo-SP-Brazil
TEL: 55-11-3568-3875 / FAX: 55-11-3568-3865

EUROPE

Deltronics (The Netherlands) B.V.

Eindhoven Office

De Witbogt 15, 5652 AG Eindhoven, The Netherlands
TEL: 31-40-2592850 / FAX: 31-40-2592851

*We reserve the right to change the information in this manual without prior notice



VFD-L-1

User Manual

Specific Drive for Wire Drawing Machinery

Preface

Thank you for choosing DELTA's high-performance VFD-L-I Series. The VFD-L-I Series is manufactured with high-quality components and materials and incorporate the latest microprocessor technology available.

This manual is to be used for the installation, parameter setting, troubleshooting, and daily maintenance of the AC motor drive. To guarantee safe operation of the equipment, read the following safety guidelines before connecting power to the AC motor drive. Keep this operating manual at hand and distribute to all users for reference.

To ensure the safety of operators and equipment, only qualified personnel familiar with AC motor drive are to do installation, start-up and maintenance. Always read this manual thoroughly before using VFD-L-I series AC Motor Drive, especially the WARNING, DANGER and CAUTION notes. Failure to comply may result in personal injury and equipment damage. If you have any questions, please contact your dealer.

PLEASE READ PRIOR TO INSTALLATION FOR SAFETY.



-
1. AC input power must be disconnected before any wiring to the AC motor drive is made.
 2. A charge may still remain in the DC-link capacitors with hazardous voltages, even if the power has been turned off. To prevent personal injury, please ensure that power has been turned off before opening the AC motor drive and wait ten minutes for the capacitors to discharge to safe voltage levels.
 3. Never reassemble internal components or wiring.
 4. Never connect the AC motor drive output terminals U/T1, V/T2, and W/T3 directly to the AC mains circuit power supply.
 5. VFD-L-I series shall NOT be used for life support equipment or any life safety situation.

This page intentionally left blank

Table of Contents

Preface	i
Table of Contents	iii
Chapter 1 Introduction	1-1
1.1 Receiving and Inspection	1-1
1.1.1 Nameplate Information	1-1
1.1.2 Model Explanation	1-1
1.1.3 Series Number Explanation	1-2
1.2 Storage	1-2
Chapter 2 Installation and Wiring	2-1
2.1 Ambient Conditions	2-1
2.2 Installation	2-1
2.3 Dimensions	2-3
2.4 Wiring	2-4
2.4.1 Basic Wiring	2-4
2.4.2 External Wiring	2-6
2.4.3 Main Terminals Connections	2-7
2.4.4 Control Terminals	2-9
Chapter 3 Start Up	3-1
3.1 Preparations before Start-up	3-1
3.2 Operation Method	3-1
3.3 Trial Run	3-1

Chapter 4 Parameters	4-1
4.1 Summary of Parameter Settings.....	4-2
4.2 Description of Parameter Settings	4-10
Chapter 5 Fault Code Information	5-1
5.1 Common Problems and Solutions	5-1
Chapter 6 Troubleshooting	6-1
6.1 Over Current (OC)	6-1
6.2 Over Voltage (OV)	6-2
6.3 Low Voltage (Lv).....	6-3
6.4 Over Heat (OH).....	6-4
6.5 Overload	6-4
6.6 Motor Stalls during Acceleration	6-5
6.7 The Motor does not Run as Expected	6-5
Chapter 7 Maintenance and Inspections	7-1
Appendix A Specifications	A-1
Appendix B Accessories	B-1
B.1 Remote Controller RC-01	B-1

1.1 Receiving and Inspection

This VFD-L-I AC motor drive has gone through rigorous quality control tests at the factory before shipment. After receiving the AC motor drive, please check for the following:

- Inspect the unit to assure it was not damaged during shipment.
- Make sure that the part number indicated on the nameplate corresponds with the part number of your order.
- There is no built-in digital keypad in the VFD-L-I series. It needs to use optional digital keypad VFD-PU06 or communication method to modify the parameters.

1.1.1 Nameplate Information

Example for 0.25HP 230V AC motor drive

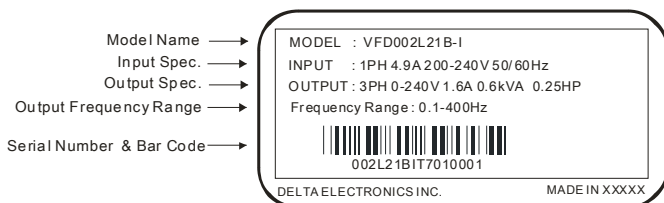

1.1.2 Model Explanation

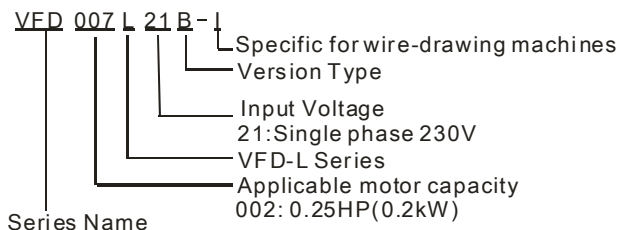

1.1.3 Series Number Explanation

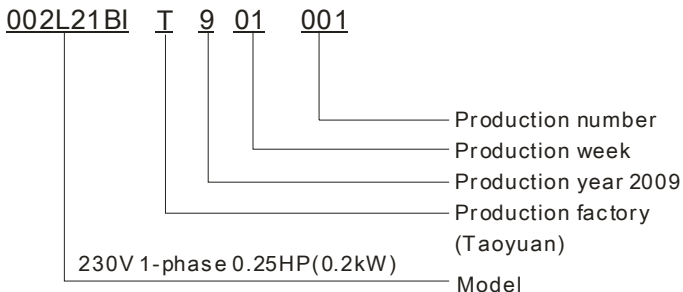

If the nameplate information does not correspond to your purchase order or if there are any problems, please contact your distributor.

1.2 Storage

The AC motor drive should be kept in the shipping carton or crate before installation. In order to retain the warranty coverage, the AC motor drive should be stored properly when it is not to be used for an extended period of time. Storage conditions are:

- Store in a clean and dry location free from direct sunlight or corrosive fumes.
- Store within an ambient temperature range of -20°C to $+60^{\circ}\text{C}$.
- Store within a relative humidity range of 0% to 90% and non-condensing environment.
- Store within an air pressure range of 86kPa to 106kPa.



CAUTION!

- DO NOT store in an area with rapid changes in temperature. It may cause condensation and frost.
- DO NOT place on the ground directly. It should be stored properly. Moreover, if the surrounding environment is humid, you should put exsiccator in the package.
- If the AC motor drive is stored for more than 3 months, the temperature should not be higher than 30°C . Storage longer than one year is not recommended, it could result in the degradation of the electrolytic capacitors.
- When the AC motor drive is not used for a long time after installation on building sites or places with humidity and dust, it's best to move the AC motor drive to an environment as stated above.

Chapter 2 Installation and Wiring

2.1 Ambient Conditions

Install the AC motor drive in an environment with the following conditions:

Operation	Air Temperature:	-10 ~ +50°C (14 ~ 122°F)
	Relative Humidity:	<90%, no condensation allowed
	Atmosphere pressure:	86 ~ 106 kPa
	Installation Site Altitude:	<1000m
	Vibration:	<20Hz: 9.80 m/s ² (1G) max 20 ~ 50Hz: 5.88 m/s ² (0.6G) max
Storage	Temperature:	-20°C ~ +60°C (-4°F ~ 140°F)
Transportation	Relative Humidity:	<90%, no condensation allowed
	Atmosphere pressure:	86 ~ 106 kPa
	Vibration:	<20Hz: 9.80 m/s ² (1G) max 20 ~ 50Hz: 5.88 m/s ² (0.6G) max
Pollution Degree	2:	good for a factory type environment.



CAUTION!

1. Operating, storing or transporting the AC motor drive outside these conditions may cause damage to the AC motor drive.
2. Failure to observe these precautions may void the warranty!

2.2 Installation

Mounting Clearances

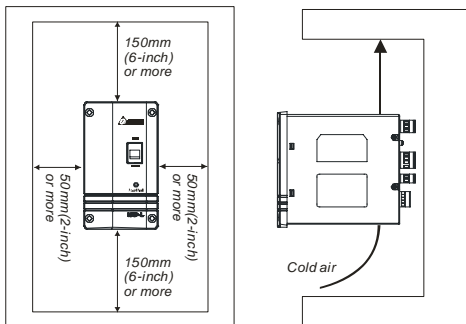

1. Mount the AC motor drive vertically on a flat vertical surface by using bolts or screws. Other directions are not allowed.
2. The AC motor drive will generate heat during operation. Allow sufficient space around the unit for heat dissipation.
3. The heat sink temperature may rise to 90°C when running. The material on which the AC motor drive is mounted must be noncombustible and be able to withstand this high temperature.
4. When the AC motor drive is installed in a confined space (e.g. cabinet), the surrounding temperature must be within 10 ~ 40°C with good ventilation. DO NOT install the AC motor drive in a space with bad ventilation.
5. When installing multiple AC motor drives in the same cabinet, they should be adjacent in a row with enough space. When installing one AC motor drive below another one, use a metal separation barrier between the AC motor drives to prevent mutual heating. Refer to figure below for details.
6. Prevent fiber particles, scraps of paper, saw dust, metal particles, etc. from adhering to the heatsink.

2.3 Dimensions

(Dimensions are in millimeter and [inch])

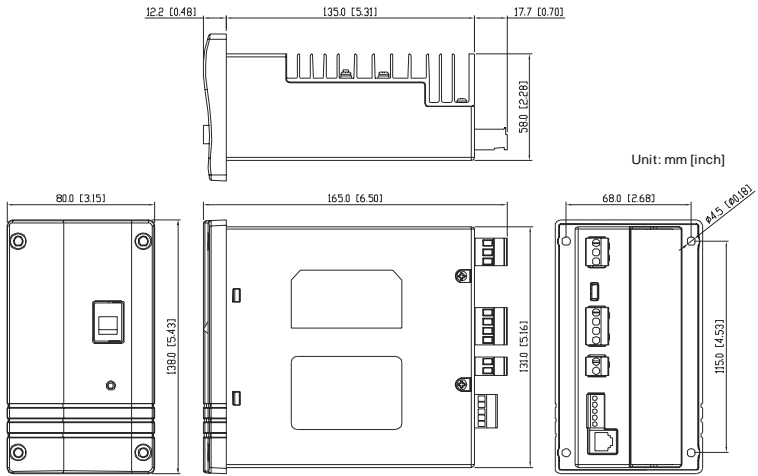

2.4 Wiring

After removing the front cover, check if the power and control terminals are clear of debris. Be sure to observe the following precautions when wiring.

2.4.1 Basic Wiring

- Make sure that power is only applied to the L1, L2 terminals. Failure to comply may result in damage to the equipment. The voltage and current should lie within the range as indicated on the nameplate.
- Check the following items after completing the wiring:
 1. Are all connections correct?
 2. No loose wires?
 3. No short-circuits between terminals or to ground?

A charge may still remain in the DC bus capacitors with hazardous voltages even if the power has been turned off. To prevent personal injury, please ensure that the power is turned off and wait ten minutes for the capacitors to discharge to safe voltage levels before opening the AC motor drive.



DANGER!

-
1. All the units must be grounded directly to a common ground terminal to prevent electric shock, fire and interference.
 2. Only qualified personnel familiar with AC motor drives are allowed to perform installation, wiring and commissioning.
 3. Make sure that the power is off before doing any wiring to prevent electric shocks.

Basic Wiring Diagrams

Users must connect wires according to the circuit diagrams on the following pages. Do not plug a modem or telephone line to the RS-485 communication port or permanent damage may result. The pins 1 & 2 are the power supply for the optional copy keypad PU06 only and should not be used for RS-485 communication.

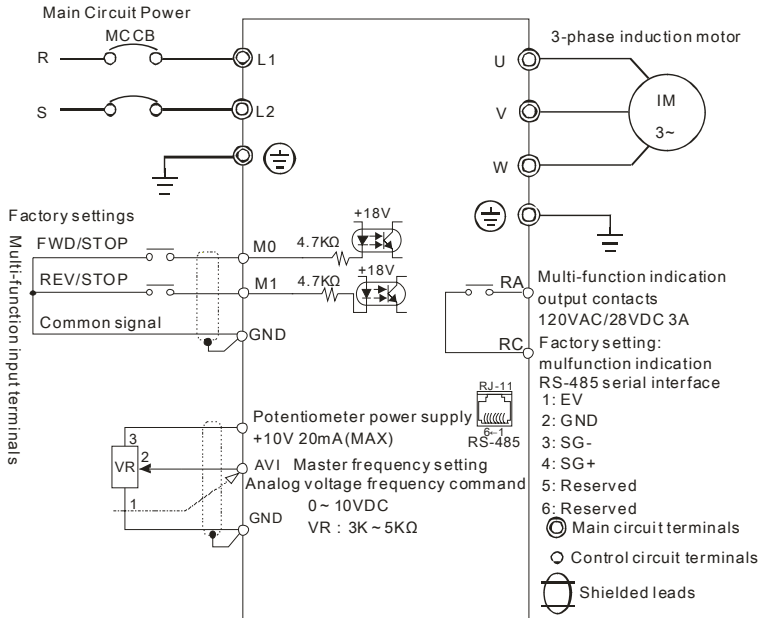

2.4.2 External Wiring

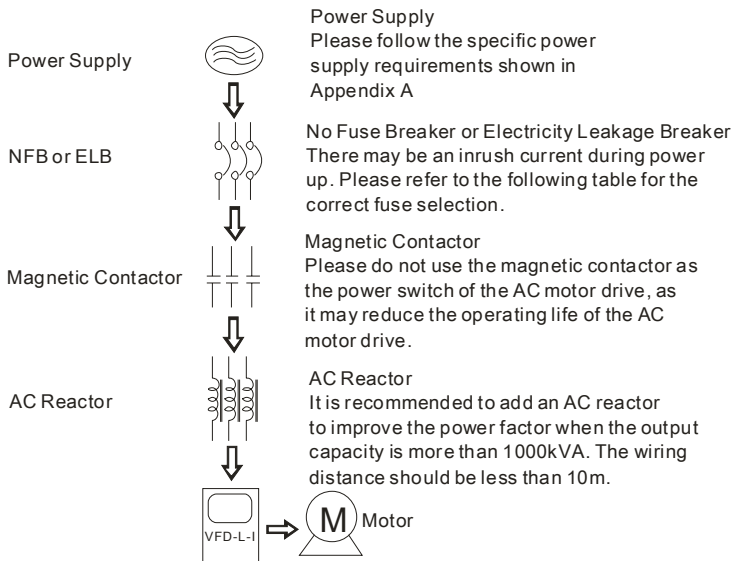

No-fuse Breaker Chart

Model	1-phase 230VAC
0.2KW/0.25HP	15A

2.4.3 Main Terminals Connections

NOTE: Terminal blocks are the removable terminals

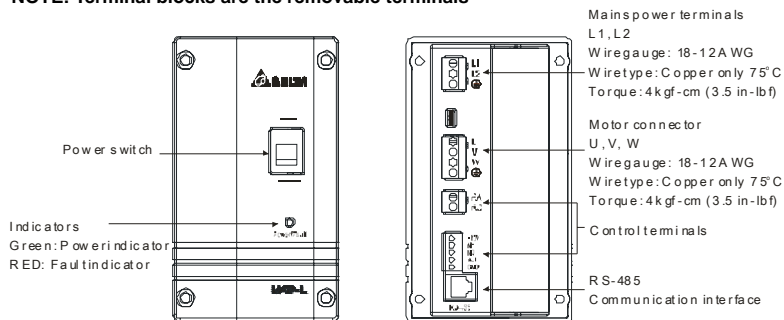

Mains power terminals

- It must have a no-fuse breaker between the AC input power and main circuit terminals (L1, L2).
- It is recommended to add a magnetic contactor (MC) in the power input wiring to cut off power quickly and reduce malfunction when activating the protection function of AC motor drives. Both ends of the MC should have an R-C surge absorber.
- Ground resistance should be less than 100Ω.
- The AC motor drive, welding machine and large horsepower motor should ground separately.
- Make sure the power voltage and max. supply current.
- Connect a brake resistor in applications with frequent deceleration ramps, short deceleration time, too low braking torque or requiring increased braking torque.
- Do not connect any output terminal (U, V, W) to the AC motor drive power.
- Please tighten the screws of the main circuit terminals to prevent a spark due to vibration.
- The wiring of main circuit and control circuit should be separated to prevent erroneous actions. If necessary let them cross only at 90° angle.
- Please use the shield wire for the control wiring and do not expose the peeled-off net in front of the terminal.
- Please use the shield wire or tube for the power wiring and ground the two ends of the shield wire or tube.
- If the AC motor drive is installed in the occasion where is sensitive to the interference, please add an RFI filter as close as the AC motor drive. With the lower of the PWM carrier frequency, it will have the less interference.

- When using a GFCI (Ground Fault Circuit Interrupter), select a current sensor with sensitivity of 200mA, and not less than 0.1-second detection time to avoid nuisance tripping.
- If the insulation of the control wire is damaged due to some reasons, it may result in the circuit damage or personal injury.
- The AC motor drive, motor and wiring may cause noise interference. Please notice the surrounding sensors and equipment to prevent erroneous actions.

Main circuit terminals (L1, L2)

- Please connect these main circuit terminals (L1, L2) to the AC power via a no-fuse breaker or electricity leakage breaker for circuit protection. It is unnecessary to consider phase-sequence.
- It is recommended to add a magnetic contactor (MC) in the power input wiring to cut off power quickly and reduce malfunction when activating the protection function of AC motor drives. Both ends of the MC should have an R-C surge absorber.

Control circuit terminals (U, V, W)

- When the AC drive output terminals U, V, and W are connected to the motor terminals U/T1, V/T2, and W/T3, respectively, the motor will rotate counterclockwise (as viewed on the shaft end of the motor) when a forward operation command is received. To permanently reverse the direction of motor rotation, switch over any of the two motor leads.

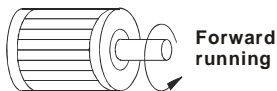

- DO NOT connect phase-compensation capacitors or surge absorbers at the output terminals of AC motor drives.
- Use a well-insulated motor, suitable for inverter operation.

Grounding terminals (⊕)

- Make sure that the leads are connected correctly and the AC drive is properly grounded.
- Use ground leads that comply with local regulations and keep them as short as possible to prevent electric shock or fire.
- Multiple VFD-L-I units can be installed in one location. All the units should be grounded directly to a common ground terminal, as shown in the figure below. **Ensure there are no ground loops.**

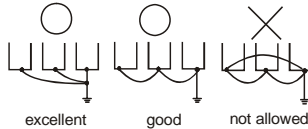

2.4.4 Control Terminals

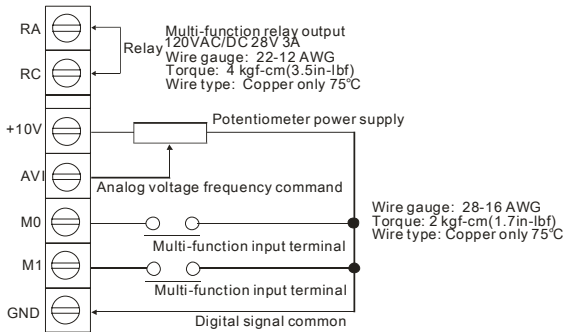

Terminal symbols and functions

Terminal Symbol	Terminal Function	Factory Settings (NPN mode) ON: Connect to GND
RA	Multi-function Relay output (N.O.) a	Output every monitor signal, such as in operation, frequency attained and overload indications. Refer to Pr.03-03 for multi-function output terminals.
RC	Multi-function Relay common	
+10V	Potentiometer power supply	+10VDC 20mA (variable resistor: 3~5kohm)

Terminal Symbol	Terminal Function	Factory Settings (NPN mode) ON: Connect to GND
AVI	Analog voltage Input	Impedance: 47k Ω Resolution: 10 bits Range: 0~10VDC = 0 ~ max. output frequency (Pr.01-00) Selection methods: Pr.02-00, Pr.07-05 Settings: Pr.04-00~Pr.04-03
M0	Multi-function auxiliary input	Refer to Pr.04-04 for programming the Multi-function Inputs.
M1	Multi-function input 1	
GND	Digital Signal Common (Sink)	Common for multi-function input terminals

Control signal wiring size: 18 AWG (0.75 mm²) with shielded wire.

Analog input terminals (AVI, GND)

- Analog input signals are easily affected by external noise. Use shielded wiring and keep it as short as possible (<20m) with proper grounding. If the noise is inductive, connecting the shield to terminal GND can bring improvement.
- If the analog input signals are affected by noise from the AC motor drive, please connect a capacitor (0.1 μ F and above) and ferrite core as indicated in the following diagrams:

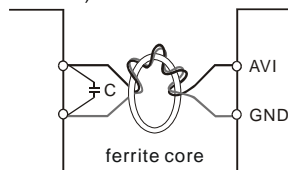

wind each wires 3 times or more around the core

Digital inputs (M0, M1, GND)

- When using contacts or switches to control the digital inputs, please use high quality components to avoid contact bounce.

General

- The wiring of main circuit and control circuit should be separated to prevent erroneous actions. If necessary let them cross only at 90° angle.
- The AC motor drive control wiring should be properly installed and not touch any live power wiring or terminals.

3.1 Preparations before Start-up

Carefully check the following items before proceeding.

- Make sure that the wiring is correct. In particular, check that the output terminals U, V, W are NOT connected to power and that the drive is well grounded.
- Verify that there are no short-circuits between terminals and from terminals to ground or mains power.
- Check for loose terminals, connectors (PG card) or screws.
- Verify that no other equipment is connected to the AC motor.
- Make sure that all switches are OFF before applying power to ensure that the AC motor drive doesn't start running and there is no abnormal operation after applying power.
- Make sure that the front cover is correctly installed before applying power.
- Do NOT operate the AC motor drive with humid hands.

3.2 Operation Method

Please choose a suitable method depending on application and operation rule. The operation is usually done as shown in the following table.

Operation Method	Frequency Source	Operation Command Source
Operate from external signal	AVI parameter setting: 02-00=1	External terminals input: M0-GND M1-GND
Operate from communication	RJ11	Communication input

3.3 Trial Run

After finishing checking the items in "3.1 preparation before start-up", you can perform a trial run.

1. After applying power, verify that the power LED lights with green.
2. Please connect a switch separately between M0-GND and M1-GND.
3. The factory setting of the source of frequency command is communication. Please set

frequency to about 5Hz with communication method.

4. Setting M0 to be ON for forward running. And if you want to change to reverse running, you should set M1 to be ON. And if you want to decelerate to stop, please set M0/M1 to be OFF.
5. Check following items:
 - *Check if the motor direction of rotation is correct.*
 - *Check if the motor runs steadily without abnormal noise and vibration.*
 - *Check if acceleration and deceleration are smooth.*

If the results of trial run are normal, please start the formal run.



NOTE

1. Stop running immediately if any fault occurs and refer to the troubleshooting guide for solving the problem.
2. Do NOT touch output terminals U, V, W when power is still applied to L1, L2 even when the AC motor drive has stopped. The DC-link capacitors may still be charged to hazardous voltage levels, even if the power has been turned off.
3. To avoid damage to components, do not touch them or the circuit boards with metal objects or your bare hands.

Chapter 4 Parameters

The VFD-L-I parameters are divided into 10 groups by property for easy setting. In most applications, the user can finish all parameter settings before start-up without the need for re-adjustment during operation.

The 10 groups are as follows:

- Group 0: User Parameters
- Group 1: Basic Parameters
- Group 2: Operation Method Parameters
- Group 3: Output Function Parameters
- Group 4: Input Function Parameters
- Group 5: Multi-Step Speed and PLC Parameters
- Group 6: Protection Parameters
- Group 7: Motor and PID Parameters
- Group 8: Special Parameters
- Group 9: Communication Parameters

4.1 Summary of Parameter Settings

↗: The parameter can be set during operation.

Group 0 User Parameters

Pr.	Explanation	Settings	Factory Setting	NOTE
00-00	Identity Code of the AC Motor Drive	1: Reserved 2: Reserved 3: 200W 4: Reserved 5: Reserved 6: Reserved	#	
00-01	Rated Current Display of the AC Motor Drive	200W: 1.6A	##.#	
00-02	Parameter Reset	10: All parameters are reset to factory settings	0	
↗00-03	Start-up Display Selection	0: Display the frequency command value (LED F) 1: Display the actual output frequency (LED H) 2: Multifunction display, see Pr.00-04 3: Display output current (LED A)	0	
↗00-04	Content of Multi-Function Display	0: Display User-Defined Unit (u) 1: Display Counter Value (C) 2: Display Process Operation (1=tt) 3: Display DC-BUS Voltage (U) 4: Display output voltage (E)	0	
↗00-05	User-Defined Coefficient	0.1 to 160	1.0	
00-06	Software Version	Read-only	##	
00-07	Password Input	0 to 999	0	
00-08	Password Set	0 to 999	0	

Group 1 Basic Parameters

Pr.	Explanation	Settings	Factory Setting	NOTE
01-00	Maximum Operation Frequency (Fmax)	50.0 to 400 Hz	100.0	
01-01	Maximum Voltage Frequency (Fbase)	10.0 to 400.00 Hz	60.0	
01-02	Maximum Output Voltage (Vmax)	2.0V to 255.0V	220.0	
01-03	Mid-Point Frequency (Fmid)	1.00 to 4000 Hz	1.00	
01-04	Mid-Point Voltage (Vmid)	2.0V to 255.0V	12.0	
01-05	Minimum Output Frequency (Fmin)	1.00 to 60.00 Hz	1.00	
01-06	Minimum Output Voltage (Vmin)	2.0V to 255.0V	12.0	
01-07	Output Frequency Upper Limit	1 to 110%	100	
01-08	Output Frequency Lower Limit	0 to 100%	0.0	
↗01-09	Accel Time 1	0.10 to 600.00 Sec	1.00	

Pr.	Explanation	Settings	Factory Setting	NOTE
01-10	Decel Time 1	0.10 to 600.00 Sec	1.00	
01-11	Accel Time 2	0.10 to 600.00 Sec	10.00	
01-12	Decel Time 2	0.10 to 600.00 Sec	10.00	
01-13	Jog Acceleration Time	0.10 to 600.00 Sec	10.00	
01-14	Jog Deceleration Time	0.00 to 600.00 Sec	10.00	
01-15	Jog Frequency	1.00 Hz to 400.00 Hz	6.0	
01-16	Auto acceleration / deceleration	0: Linear Accel/Decel 1: Auto Accel, Linear Decel 2: Linear Accel, Auto Decel 3: Auto Accel/Decel 4: Linear Accel; Auto Decel, Stall Prevention during Decel 5: Auto Accel/Decel, Stall Prevention during Decel	0	
01-17	Acceleration S-Curve	0 to 7	0	
01-18	Deceleration S-Curve	0 to 7	0	

Group 2 Operation Method Parameters

Pr.	Explanation	Settings	Factory Setting	NOTE
02-00	Source of Master Frequency Command	0: Reserved 1: Master Frequency determined by analog signal DC 0V-10V (external terminal AV1). 2: Reserved 3: Reserved 4: Master Frequency operated by RS-485 serial communication interface	4	
02-01	Source of Operation Command	0: Reserved 1: External terminals. Keypad STOP enabled. 2: External terminals. Keypad STOP disabled. 3: RS-485 serial communication. Keypad STOP enabled. 4: RS-485 serial communication. Keypad STOP disabled. 5: Force to run when applying the power.	1	
02-02	Stop Method	0: STOP: ramp to stop 1: STOP: coast to stop	1	
02-03	PWM Carrier Frequency Selections	3 to 10kHz	10	
02-04	Motor Direction Control	0: Enable forward/reverse operation 1: Disable reverse operation 2: Disable forward operation	1	
02-05	Reserved			

Pr.	Explanation	Settings	Factory Setting	NOTE
02-06	Line Start Lockout	0: Disable 1: Enable	1	

Group 3 Output Function Parameters

Pr.	Explanation	Settings	Factory Setting	NOTE
03-00	Desired Frequency Attained	1.00 to 400.00 Hz	1.00	
↗03-01	Terminal Count Value	0 to 999	0	
↗03-02	Preliminary Count Value	0 to 999	0	
↗03-03	Multi-Function Output Terminal (Relay)	0: No Function 1: AC Drive Operational 2: Master Frequency Attained 3: Zero Speed 4: Over Torque Detection 5: Base-Block (B.B.) Indication 6: Low-Voltage Indication 7: Operation Mode Indication 8: Fault Indication 9: Desired Frequency Attained 10: PLC Program Running 11: PLC Program Step Completed 12: PLC Program Completed 13: PLC Program Operation Paused 14: Terminal Count Value Attained 15: Preliminary Count Value Attained 16: AC Motor Drive Ready	8	

Group 4 Input Function Parameters

Pr.	Explanation	Settings	Factory Setting	NOTE
↗04-00	Potentiometer Bias Frequency	0.00 to 350.00Hz	0.00	
↗04-01	Potentiometer Bias Polarity	0: Positive Bias 1: Negative Bias	0	
↗04-02	Potentiometer Frequency Gain	1 to 200 %	100	
04-03	Potentiometer Reverse Motion Enable	0: No Function 1: Reverse Motion enabled 2: Reverse Motion disabled	0	

Pr.	Explanation	Settings	Factory Setting	NOTE
04-04	Multi-Function Input Terminal 1 (M0, M1)	0: No Function 1: M0: FWD/STOP, M1: REV/STOP 2: M0: FWD/REV, M1: RUN/STOP 3: Reserved 4: E.F. External Fault Input (N.O.) 5: E.F. External Fault Input (N.C.) 6: Reset 7: Multi-Step Speed Command 1 8: Multi-Step Speed Command 2 9: Jog Operation 10: Accel/decel Inhibit 11: First or Second Acceleration/deceleration Time Selection 12: External base block (N.O.) 13: External base block (N.C.) 14: Up: Increment master frequency 15: Down: Decrement master frequency 16: Run PLC Program 17: Pause PLC Program 18: Counter Trigger Signal 19: Counter Rese	1	
04-05	Reserved			
04-06	Reserved			

Group 05 Multi-Step Speed and PLC Parameters

Pr.	Explanation	Settings	Factory Setting	NOTE
05-00	1st Step Speed Freq.	0.00 to 400.00 Hz	0.00	
05-01	2nd Step Speed Freq.	0.00 to 400.00 Hz	0.00	
05-02	3rd Step Speed Freq.	0.00 to 400.00 Hz	0.00	
05-03	PLC Mode	0: Disable PLC Operation 1: Stop after executing one program cycle 2: Continuously execute program cycles 3: Execute one program cycle step by step 4: Continuously execute one program cycle step by step	0	
05-04	PLC Forward/ Reverse Motion	0 to 15 (0: FWD 1: REV)	0	
05-05	Time Duration of Zero Step Speed	0 to 65500 Sec	0	
05-06	Time Duration of 1st Step Speed	0 to 65500 Sec	0	
05-07	Time Duration of 2nd Step Speed	0 to 65500 Sec	0	
05-08	Time Duration of 3rd Step Speed	0 to 65500 Sec	0	

Group 6 Protection Parameters

Pr.	Explanation	Settings	Factory Setting	NOTE
06-00	Over-Voltage Stall Prevention Level	0: Disable 350 to 410V	390	
06-01	Over-Current Stall Prevention Level	0: Disable 20 to 200%	170	
06-02	Over-Torque Detection Mode	0: Disabled 1: Enabled during constant speed operation. After the over-torque is detected, keep running. 2: Enabled during constant speed operation. After the over-torque is detected, keep running until OL2 occurs. 3: Enabled during acceleration operation. After the over-torque is detected, keep running. 4: Enabled during acceleration operation. After the over-torque is detected, keep running until OL2 occurs.	0	
06-03	Over-Torque Detection Level	30 to 200%	150	
06-04	Over-Torque Detection Time	0.1 to 10.0 Sec	0.1	
06-05	Electronic Thermal Overload Relay Selection	0: Disable 1: Standard motor 2: Special motor	0	
06-06	Electronic Thermal Characteristic	30 to 600 Sec	60	
06-07	Present Fault Record	0: No fault 1: Over current (oc) 2: Over voltage (ov)	0	
06-08	Second Most Recent Fault Record	3: Over heat (oH) 4: Over load (oL) 5: Over load (oL1)		
06-09	Third Most Recent Fault Record	6: External fault (EF) 7: Reserved		
06-10	Fourth Most Recent Fault Record	8: Reserved 9: Over current during acceleration (ocA)		
06-11	Fifth Most Recent Fault Record	10: Over current during deceleration (ocd)		
06-12	Sixth Most Recent Fault Record	11: Over current during steady state (ocn)		

Group 7 Motor Parameters

Pr.	Explanation	Settings	Factory Setting	NOTE
∞07-00	Motor Rated Current	30 to 120%	85	
∞07-01	Motor No-Load Current	0 to 90%	50	
∞07-02	Torque Compensation	0 to 10	1	

Pr.	Explanation	Settings	Factory Setting	NOTE
↯07-03	Slip Compensation	0.0 to 10.0	0.0	
07-04	PID Control Mode Selection	0: No function 1: PID Modulation of Master frequency 2: PID modulation + Master frequency shift	2	
07-05	PID Set Point Selection	0: Reserved 1: 0 to 10V from AVI 2: Reserved 3: Set by Pr.07-19 4: RS-485 communication interface		
07-06	Input terminal for PID Feedback	0: Positive PID feedback from external terminal (AVI) 0 to +10V 1: Reserved 2: Negative PID feedback from external terminal (AVI) 0 to +10V 3: Reserved	0	
↯07-07	Proportional Gain (P)	0.0 to 10.0	0.2	
↯07-08	Integral Time (I)	0 to 1000 (*20ms)	150	
↯07-09	Differential Control (D)	0 to 20 (*20ms)	0	
07-10	Upper Bound for Integral Control	0 to 100%	100	
07-11	Integral Value Limit	0: Disable 1: Positive value only	0	
07-12	PID Extension Function	Bit 0: PID offset Bit 1: Sign number of PID offset Bit 2: Modulation time of Proportional Gain	0	
07-13	PID Offset	0.00 to 400.00	20.00	
07-14	Modulation Time of P	0 to 1000 (*20ms)	1000	
07-15	Max. Feedback Signal	0.00 to 100.00%	80.00	
07-16	Min. Feedback Signal	0.00 to 100.00%	20.00	
07-17	Treatment of the Erroneous Feedback Signals	0: difference of PID setting frequency and feedback is 0 (integral value is not changed) 1: difference of PID setting frequency and feedback is 0 (integral value=0) 2: stop the AC motor drive	1	
07-18	Feedback Signal Detection Time	0 to 10000 (*20ms)	150	
07-19	PID Target Value	0.00 to 10.00V	5.00	
07-20	Reserved			
07-21	Soft Start Function	0: Disable 1: Enable	1	
07-22	Detection Range of Soft Start	0.00 to 100.00%	0.10	
07-23	Delay for Soft Start Error	0 to 1000 (*20ms)	1000	

Group 8 Special Parameters

Pr.	Explanation	Settings	Factory Setting	NOTE
08-00	DC Braking Voltage Level	0 to 30%	0	
08-01	DC Braking Time during Start-Up	0.0 to 60.0 Sec	0.0	
08-02	DC Braking time during Stopping	0.0 to 60.0 Sec	0.0	
08-03	Start-Point for DC Braking	0.0 to 400.0 Hz	0.0	
08-04	Momentary Power Loss Operation Selection	0: Operation stops after Momentary Power Loss 1: Operation continues after momentary power loss, speed search starts with the Master Frequency reference value 2: Operation continues after momentary power loss, speed search starts with the minimum frequency	0	
08-05	Maximum Allowable Power Loss Time	0.3 to 5.0 Sec	2.0	
08-06	B.B. Time for Speed Search	0.3 to 5.0 Sec	0.5	
08-07	Current Limit for Speed Search	30 to 200%	150	
08-08	Skip Frequency 1 Upper Limit	0.0 to 400 Hz	0.0	
08-09	Skip Frequency 1 Lower Limit	0.0 to 400 Hz	0.0	
08-10	Skip Frequency 2 Upper Limit	0.0 to 400 Hz	0.0	
08-11	Skip Frequency 2 Lower Limit	0.0 to 400 Hz	0.0	
08-12	Skip Frequency 3 Upper Limit	0.0 to 400 Hz	0.0	
08-13	Skip Frequency 3 Lower Limit	0.0 to 400 Hz	0.0	
08-14	Auto Restart After Fault	0 to 10	0	
08-15	AVR Function	0: Enable 1: Disable 2: Disable when deceleration	2	
08-16	Software Braking Level	350 to 450V	380	
08-17	DC Braking Lower Bound Limit	0.0 to 400 Sec	0.0	

Group 9 Communication Parameters

Pr.	Explanation	Settings	Factory Setting	NOTE
↗09-00	Communication Address	1 to 247	1	
↗09-01	Transmission Speed	0: Baud Rate 4800 bps 1: Baud Rate 9600 bps 2: Baud Rate 19200 bps	1	
↗09-02	Transmission Fault Treatment	0: Warn and Keep Operating 1: Warn and Ramp to Stop 2: Warn and Coast to Stop 3: Keep Operating without Warning	0	
↗09-03	Time-out Detection	0: Disable 1 to 20: 1 to 20 sec	0	
↗09-04	Communication Protocol	ASCII mode 0: 7,N,2 1: 7,E,1 2: 7,O,1	0	

Pr.	Explanation	Settings		Factory Setting	NOTE
			3: 8,N,2 4: 8,E,1 5: 8,O,1 6: 8,N,2		
		RTU mode	7: 8,E,1 8: 8,O,1		

4.2 Description of Parameter Settings

Group 0: User Parameters

✎ This parameter can be set during operation.

00-00	Identity Code of the AC Motor Drive	Factory setting: 3
Settings	Read Only	

📖 Pr. 00-00 displays the identity code of the AC motor drive. At the meanwhile, it can read Pr.00-01 to check the rated current.

00-01	Rated Current Display of the AC motor drive	Unit: 0.1A Factory setting: 1.6A
Settings	Read Only	

📖 Pr. 00-01 displays the rated current of the AC motor drive. By reading this parameter the user can check if the AC motor drive is correct.

00-02	Parameter Reset	Factory Setting: 0
Settings	0-9 10	No function All parameters are reset to factory settings

📖 This setting allows the user to return all parameters to the factory default settings.

00-03	✎ Start-up Display Selection	Factory Setting: 0
Settings	0 1 2 3	Display the frequency command value (LED F) Display the actual output frequency (LED H) Multifunction display, see Pr.00-04 Display output current (LED A)

📖 This parameter is used to set the start-up display.

00-04	✎ Content of Multi-function Display	Factory Setting: 0
Settings	0 1 2 3 4	Display the user-defined unit (u) Display the counter value (C) Display the content of PLC time (1=t) Display the DC BUS voltage (U) Display the output voltage (E)

 Display the user-defined unit, where unit = H X Pr.00-05

00-05	User Defined Coefficient K	Unit: 0. 1
Settings	0.1 to 160	Factory Setting: 1.0

 The coefficient K determines the multiplying factor for the user-defined unit.

The display value is calculated as follows:

Display value = (output frequency x K)

Display Value	Actual Value
66.6	66.6
666	666
666.	6660
66.6.	66600

00-06	Software Version	
Settings	Read Only	
Display	#. #	

00-07	Password Input	Unit: 1
Settings	0 to 999	Factory Setting: 0
Displays	0: no password / correct password has been input 1: parameters are locked	

 When this parameter displays 1, it means that all the parameters are locked. It needs to enter correct password to unlock the parameters. When the change of the parameter is finished, it will be locked again after inputting value except password.

 If the parameters are locked by the password, it needs to input correct password to set the parameters after power is turned on again.

00-08	Password Set	Unit: 1
Settings	0 to 999	Factory Setting: 0
Display	0 No password set 1 Password has been set	

 When Pr.00-08 is set to 0, all parameters can be changed. When Pr.00-08 is set to any value except 0, all parameters will be locked and can't be changed. To set a new password, please enter the new password twice in this parameter.

Group 1: Basic Parameters

01-00	Maximum Operation Frequency (Fmax)	Unit: 0.01Hz
Settings	50.0 to 400.00 Hz	Factory Setting: 100.00

 This parameter determines the AC motor drive's Maximum Operation Frequency. All the AC motor drive frequency command sources (analog inputs 0 to +10V and 4 to 20mA) are scaled to correspond to the output frequency range.

01-01	Maximum Voltage Frequency (Fbase)	Unit: 0.1
Settings	10.00 to 400.00 Hz	Factory Setting: 60.0

 This value should be set according to the rated voltage frequency of the motor as indicated on the motor nameplate.

01-02	Maximum Output Voltage (Vmax)	Unit: 0.1
Settings	2.0 to 255.0V	Factory Setting: 220.0

 This parameter determines the Maximum Output Voltage of the AC motor drive. The Maximum Output Voltage setting must be set according to the rated voltage of the motor as indicated on the motor nameplate.

01-03	Mid-Point Frequency (Fmid)	Unit: 0.01Hz
Settings	1.00 to 400.00Hz	Factory Setting: 1.00

 This parameter sets the Mid-Point Frequency of the V/f curve. With this setting, the V/f ratio between Minimum Frequency and Mid-Point frequency can be determined.

01-04	Mid-Point Voltage (Vmid)	Unit: 12.0
Settings	2.0 to 255.0V	Factory Setting: 0.1V

 This parameter sets the Mid-Point Voltage of any V/f curve. With this setting, the V/f ratio between Minimum Frequency and Mid-Point Frequency can be determined.

01-05	Minimum Output Frequency (Fmin)	Unit: 0.01Hz
Settings	1.0 to 60.00Hz	Factory Setting: 1.0

 This parameter sets the Minimum Output Frequency of the AC drive.

01-06	Minimum Output Voltage (Vmin)	Unit: 12.0
Settings	2.0 to 255V	Factory Setting: 0.1V

- 📖 This parameter sets Minimum Output Voltage of the AC drive.
- 📖 The setting of parameters 01-01 to 01-06 should comply with Pr.01-02≥ Pr.01-04≥ Pr.01-06 : Pr.01-01≥ Pr.01-03≥ Pr.01-05.

01-07	Output Frequency Upper Limit	Unit: 1%
	Settings 1 to 110%	Factory Setting: 100
01-08	Output Frequency Lower Limit	Unit: 1%
	Settings 0 to 100%	Factory Setting: 0

- 📖 The Maximum Output Frequency (Pr.01-00) is regarded as 100%.
- 📖 The Upper/Lower Limit is to prevent operation error and machine damage.
- 📖 Assume that the output frequency upper limit is set to 90% and max. operation frequency Pr.01-00 is 60Hz, max. output frequency should be 54Hz. If the output frequency lower limit is set to 10% and min. output frequency is 1.5Hz, it will run with 6Hz as the setting frequency is less than 6Hz after start-up.

01-09	Acceleration Time 1 (Taccel 1)	Unit: 0.01
01-10	Deceleration Time 1 (Tdecel 1)	Unit: 0.01
	Settings 0.10 to 600.00Sec	Factory Setting: 1.00
01-11	Acceleration Time 2 (Taccel 2)	Unit: 0.01
01-12	Deceleration Time 2 (Tdecel 2)	Unit: 0.01
	Settings 0.10 to 600.00Sec	Factory Setting: 10.00

- 📖 The acceleration time means the time required for the AC drive to ramp from 0 Hz to its Maximum Output Frequency (Pr.01-00). The deceleration time means the time required for the AC drive to decelerate from the Maximum Output Frequency (Pr.01-00) down to 0 Hz.
- 📖 A Multi-Function Input terminal must be programmed to select acceleration/deceleration time 2 and the terminals must be closed to select acceleration/deceleration time 2.
- 📖 In the diagram shown below, the acceleration/deceleration time of the AC drive is the time between 0 Hz to Maximum Operation Frequency (Pr.01-00). If the Maximum Output Frequency is 60 Hz, the actual time for the AC drive to accelerate from start-up to 60 Hz is 9.83 seconds and the deceleration time is also 9.83 seconds.

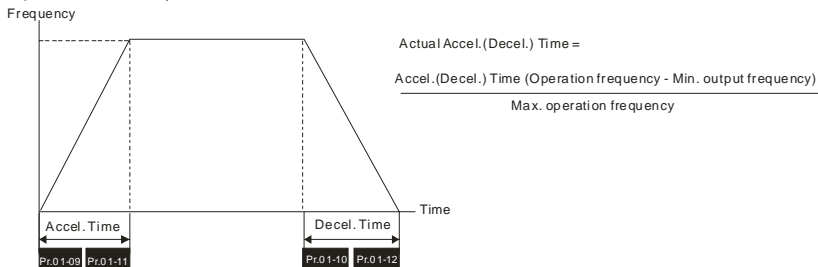

01-13	↗ Jog Acceleration Time	Unit: 0.01Sec
Settings	0.10 to 600.00Sec	Factory Setting: 10.00
01-14	↘ Jog Deceleration Time	Unit: 0.01Sec
Settings	0.00 to 600.00Sec	Factory Setting: 10.00
01-15	↗ Jog Frequency	Unit: 0.01Hz
Settings	1.00 to 400.00Hz	Factory Setting: 6.00

The JOG function can be selected using Multi-function Input terminals (one of M1-M3) if programmed for Jog (10). When the Jog terminal is “closed”, the AC drive will accelerate from Minimum Output Frequency (Pr.01-05) to Jog Frequency (Pr.01-15). When the Jog terminal “open”, the AC drive will decelerate from Jog Frequency to zero. The acceleration/deceleration time is decided by the Jog acceleration/deceleration time (Pr.01-13, 01-14). During operation, the AC drive cannot perform Jog command. And during Jog operation, other operation commands cannot be accepted, except command of FORWARD, REVERSE and STOP keys on the digital keypad.

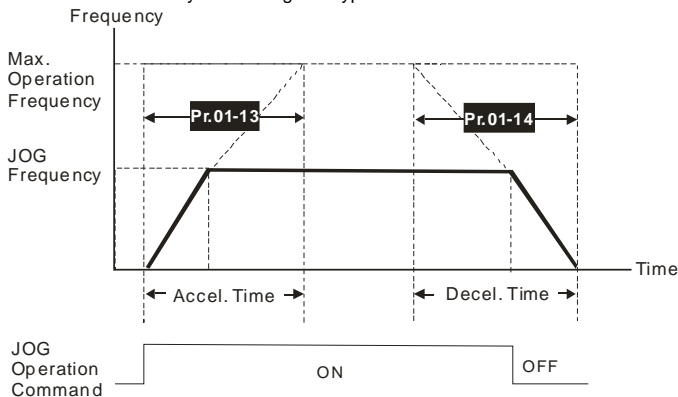

01-16 / Auto-Acceleration / Deceleration

Factory Setting: 0

Settings	0	Linear Accel/Decel
	1	Auto Accel, Linear Decel
	2	Linear Accel, Auto Decel
	3	Auto Accel/Decel (Set by load)
	4	Linear Accel; Auto Decel, Stall Prevention during Decel
	5	Auto Accel/Decel, Stall Prevention during Decel

 If the auto acceleration/deceleration is selected, the AC drive will acceleration/deceleration in the fastest and smoothest means possible by automatically adjusting the time of acceleration/deceleration. When Pr.01-16 is set to linear accel/decel, the AC drive will acceleration/deceleration with linear or S curve way.

01-17 Acceleration S-Curve**01-18** Deceleration S-Curve

Settings 0 to 7

Factory Setting: 0

 These two parameters allow you to configure whether the acceleration and/or deceleration ramps are linear or S-shaped. The S-curve is enabled when set at 1-7. When this function is enabled, the AC motor drive will accel/decel with different speed according to the original accel./decel. time. When it is set to 0, it is linear acceleration/deceleration.

 From the diagram shown below, the original setting acceleration/deceleration time will be for reference when the function of the S-curve is enabled. The actual acceleration/deceleration time will be longer with the increased setting.

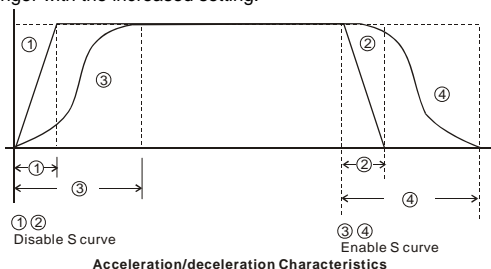

Group 2: Operation Method Parameters

02-00 / Source of Master Frequency Command

Factory Setting: 4

Settings	0	Reserved
	1	Master Frequency determined by analog signal DC 0V-10V (external terminal AVI).
	2	Reserved
	3	Reserved
	4	Master Frequency operated by RS-485 serial communication interface (RJ11)

 This parameter sets the Frequency Command Source of the AC drive. The source of the master frequency can be external terminal AVI (DC 0 to +10V) or RS-485 communication interface.

02-01 / Source of Operation Command

Factory Setting: 1

Settings	0	Reserved
	1	External terminals. Keypad STOP enabled.
	2	External terminals. Keypad STOP disabled.
	3	RS-485 serial communication. Keypad STOP enabled.
	4	RS-485 serial communication. Keypad STOP disabled.
	5	Force to run when applying the power.

 When the AC drive is controlled by an external source, please refer to parameter group 4 for detailed explanations on related parameter settings.

02-02 Stop Method

Factory Setting: 1

Settings	0	STOP: ramp to stop
	1	STOP: coast to stop

 The parameter determines how the motor is stopped when the AC motor drive receives a valid stop command or detects External Fault.

- Ramp: the AC motor drive decelerates to Minimum Output Frequency (Pr.01-05) according to the deceleration time set in Pr.01-10 or Pr.01-12 and then stops.
- Coast: the AC motor drive stops the output instantly upon command, and the motor free runs until it comes to a complete standstill.

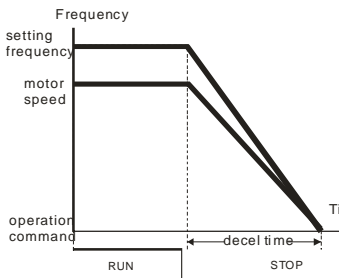

Figure 1: ramp to stop

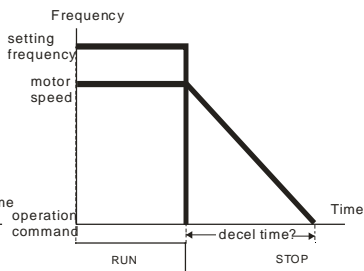

Figure 2: free run to stop

The motor stop method is usually determined by the characteristics of the motor load and how frequently it is stopped.

- (1) It is recommended to use “ramp to stop” for safety of personnel or to prevent material from being wasted in applications where the motor has to stop after the drive is stopped. The deceleration time has to be set accordingly. (figure 1)
- (2) If motor free running is allowed or the load inertia is large, it is recommended to select “coast to stop”. For example: blowers, pumps and mixers .(figure 2)

02-03 PWM Carrier Frequency Selections

Unit: 1kHz

Settings 3 to 10 kHz

Factory Setting: 10



This parameter determines the PWM carrier frequency of the AC motor drive.

Carrier Frequency	Electromagnetic Noise	Noise, leakage current	Heat dissipation
3kHz	Significant ↑ ↓ Minimal	Minimal ↑ ↓ Significant	Minimal ↑ ↓ Significant
5kHz			
10kHz			



From the table, we see that the PWM carrier frequency has a significant influence on the electromagnetic noise, AC motor drive heat dissipation, and motor acoustic noise.

02-04 Motor Direction Control

Factory Setting: 1

Settings	0	Enable forward/reverse operation
	1	Disable reverse operation
	2	Disable forward operation



-  If this parameter is set to disable reverse operation, the reverse command of keypad and external terminal REV will be invalid.

02-05 Reserved

02-06 Line Start Lockout

Factory Setting: 1

Settings	0	Disable
	1	Enable

-  This parameter is used to determinate the operation status of motor when the power is turned on as the operation command is from the external terminal and the command is hold. When it is set to 0, the AC drive will receive the operation command and the motor will run.
-  When it is set to 1, the AC drive won't receive the operation command and the motor will stop. It needs to give RUN command after the operation command is cancelled to run the motor.

Group 3: Output Function Parameters

03-00	Desired Frequency Attained	Unit: 0.01Hz
Settings	1.00 to 400.00 Hz	Factory Setting: 1.00

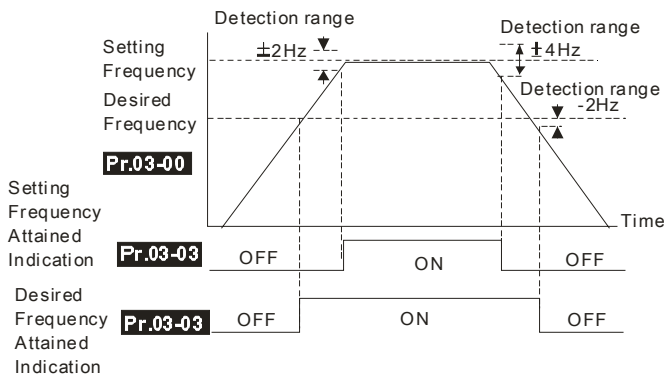

-  If a multi-function output terminal is set to function as Desired Frequency Attained (Pr.03-03=9), then the output will be activated when the programmed frequency is attained.



03-01	Terminal Count Value	Unit: 1
Settings	0 to 999	Factory Setting: 0

-  The parameter determines the upper limit value of the internal counter. The internal counter can be triggered by the external terminal (one of M1-M3). Upon completion of counting, the specified output terminal will be activated.

03-02	Preliminary Count Value	Unit: 1
Settings	0 to 999	Factory Setting: 0

-  When the counter value is counted up from "1" to the setting value of this parameter, the corresponding multi-function output terminal will be closed as Preliminary Counter Value Attained. The application can be that closing the multi-function output terminal makes the AC drive operate at low speed until stop before the counting value is going to be attained.
-  The timing diagram is shown below:

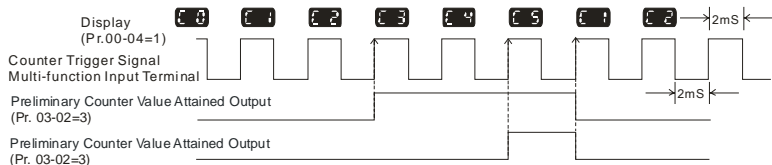

03-03 Multi-function Output Terminal 1 (Relay)

Unit: 1

Settings 0 to 16

Factory Setting: 8

Setting	Function	Description
0	No Function	
1	AC Drive Operational	the output terminal will be activated when the drive is running.
2	Setting Frequency Attained	the output will be activated when the AC drive attains the Setting Frequency.
3	Zero Speed	the output will be activated when Command Frequency is lower than the Minimum Output Frequency.
4	Over Torque Detection	the output will be activated as long as the over-torque is detected. Pr.06-03 determines the Over-Torque detection level and Pr.06-04 determines the Over-Torque detection time.
5	Base-Block (B.B.) Indication	the output will be activated when the output of the AC drive is shut off by external Baseblock.
6	Low-Voltage Indication	the output will be activated when low voltage is detected.
7	Operation Mode Indication	the output will be activated when the operation of the AC drive is controlled by External Control Terminals.
8	Fault Indication	the output will be activated when faults occur
9	Desired Frequency Attained	the output will be activated when the desired frequency (Pr.03-00)is attained.
10	PLC Program Running	the output will be activated when the PLC program is running.
11	PLC Program Step Completed	the output will be activated for 0.5 sec. when each multi-step speed is attained.
12	PLC Program Completed	the output will be activated for 0.5 sec. when the PLC program cycle has completed.

Setting	Function	Description
13	PLC Operation Paused	the output will be activated when PLC operation is paused.
14	Terminal Count Value Attained	the output will be activated when counter reaches Terminal Count Value(Pr.03-01).
15	Preliminary Counter Value Attained	the output will be activated when counter reaches Preliminary Count Value(Pr.03-02).
16	AC Motor Drive Ready	

Group 4: Input Function Parameters

04-00	↗ Potentiometer Bias Frequency	Unit: 0.01Hz
Settings	0.00 to 350.00Hz	Factory Setting: 0.00

04-01	Potentiometer Bias Polarity	Factory Setting: 0
Settings	0 Positive Bias	
	1 Negative Bias	

04-02	↗ Potentiometer Frequency Gain	Unit: 1
Settings	1 to 200%	Factory Setting: 100

04-03	Potentiometer Reverse Motion Enable	Factory Setting: 0
Settings	0 No Function	
	1 Reverse Motion enabled	
	2 Reverse Motion disabled	

 Pr.04-00 to Pr.04-03 are used when the source of frequency command is the analog signal (0 to +10V DC). Refer to the following examples.

$$\text{SET_FRER} = \text{FEXT} * (\text{Pr.04-02}) + (\text{Pr.04-01}) + (\text{Pr.04-00})$$

Example 1:

The following is the most common method. It can set parameter 02-00 to 1 (0 to +10V signal) to set the frequency by external terminals (potentiometer).

Max. operation frequency **Pr.01-00**

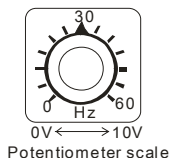
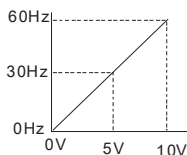

Factory setting

Pr.01-00=60Hz	Max. operation frequency
Pr.04-00=0Hz	Potentiometer bias frequency
Pr.04-01=0	Bias polarity
Pr.04-02=100%	Potentiometer frequency gain
Pr.04-03=0	Forward motion only

Example 2:

In this example with the potentiometer set to 0V the Output Frequency is 10 Hz. The mid-point of the potentiometer becomes 40 Hz. Once the Maximum Output Frequency is reached any further increase of the potentiometer will not increase output frequency.

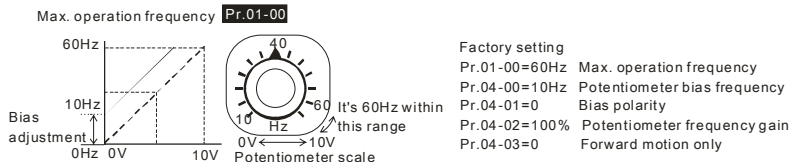
**Example 3:**

The example also shows the popular method. The whole scale of the potentiometer can be used as desired. In addition to signals of 0 to 10V, the popular voltage signals also include signals of 0 to 5V, or that under 10V. Regarding the setting, please refer to the following examples.

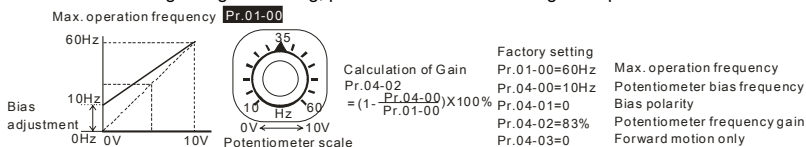
**Example 4:**

This example shows a potentiometer range of 0 to 5 Volts. Except gain adjustment, it can set Pr.01-00 to 120Hz to reach the same result.

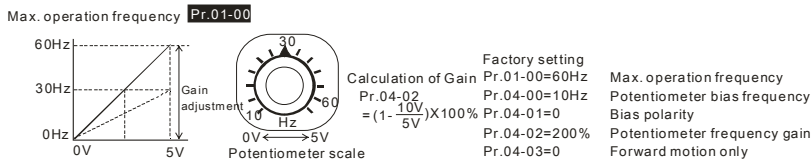
**Example 5:**

In this example a 1 volt negative bias is used. In a noise environment, it is advantageous to use negative bias to provide a noise margin (1V in this example).

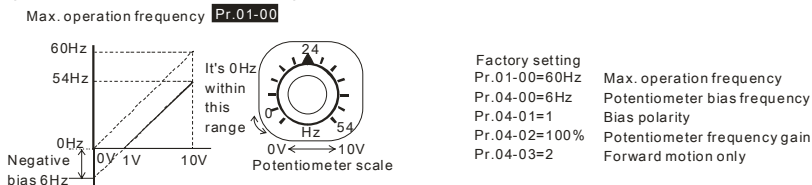

Example 6:

In this example, a negative bias is used to provide a noise margin. Also a potentiometer frequency gain is used to allow the Maximum Output Frequency to be reached.

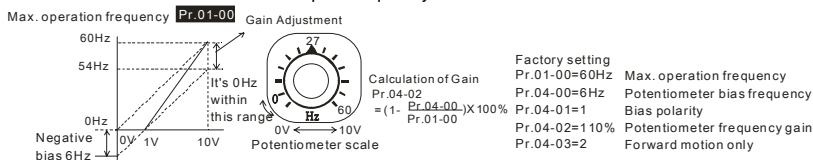

Example 7:

This example with FWD/REV application can be easily used with system for the complicated application. When this application is set, external FWD and REV command will auto be invalid.

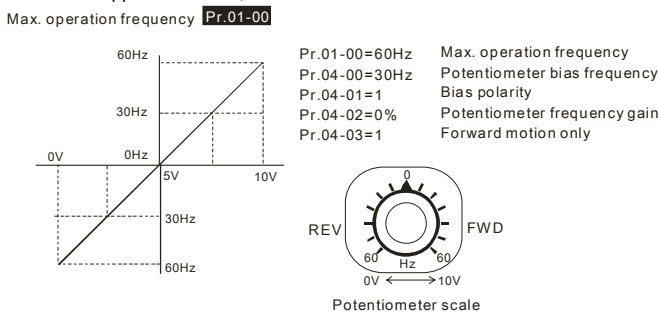

Example 8:

In this example, the option of anti-slope is shown. Anti-slope is used in an application where control of pressure, temperature, or flow is needed. Under a high pressure or flow situation, a sensor will generate a large signal. With anti-slope enable, the large signal will slow or stop the AC drive. Please notice that it can't change the direction in this application, it only can change the AC drive to reverse running.

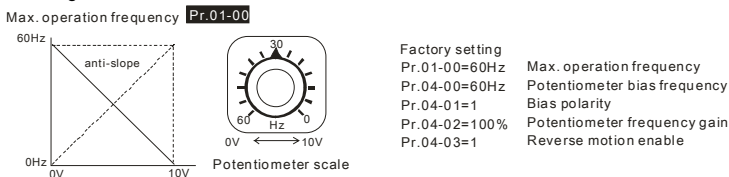

04-04	Multi-function Input Terminal (M0, M1)	Factory Setting: 1
Settings	0 to 20	

Parameters & Functions table:

Value	Function	Value	Function
0	No Function	11	First or Second Acceleration or Deceleration Time Selection
1	M0: FWD / STOP, M1: REV / STOP	12	External Base Block (N.O.) (Normally Open Contact Input)
2	M0: RUN / STOP, M1: FWD / REV	13	External Base Block (N.C.) (Normally Close Contact Input)
3	Reversed	14	Up: Increment master frequency
4	External Fault (Normally Open)	15	Down: Decrement master frequency
5	External Fault (Normally Closed)	16	Run PLC Program
6	External Reset	17	Pause PLC Program
7	Multi-Step Speed Command1	18	Counter Trigger Signal
8	Multi-Step Speed Command2	19	Counter Reset
9	Jog operation		
10	Acceleration/Deceleration Speed Inhibit		

Explanations:**0 Parameter Disable:**

Enter value (0) to disable any Multi-Function Input Terminal: M1 (Pr.04-04)

**NOTE**

The purpose of this function is to provide isolation for unused Multi-Function Input Terminals. Any unused terminals should be programmed to 0 to insure they have no effect on drive operation.

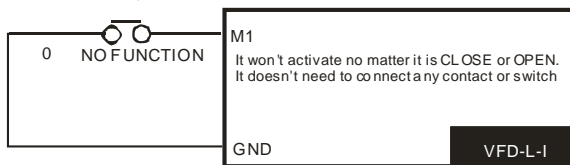

1, 2 Two wire operation (mode 1): Restricted to Pr.04-04 and external terminals M0, M1.

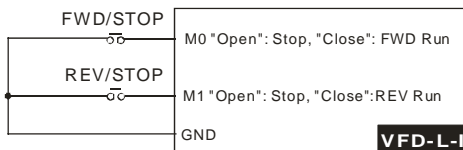

1, 2 Two wire operation (mode 2): Restrict to Pr. 04-04 and external terminals M0, M1.

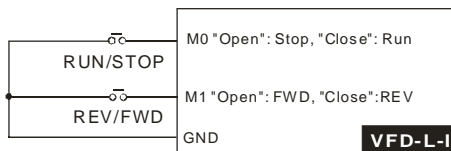

4, 5 External Faults (E.F.)

Parameter values 4, 5 programs Multi-Function Input Terminals: M1 (Pr. 04-04) to be External Fault (E.F.) inputs.

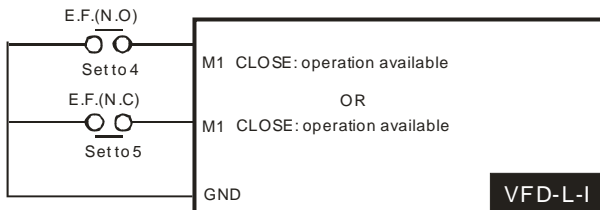

When an External Fault input signal is received, the AC drive will stop all output and display “E.F.” on Digital Keypad, the motor will free run. Normal operation can resume after the External Fault is cleared and the AC drive is reset.

6 External Reset:

Parameter value 6 programs a Multi-Function Input Terminal: M1 (Pr.04-04) to be an External Reset.

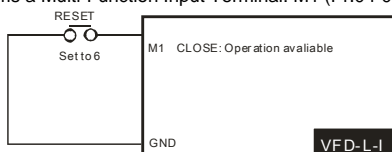

The External Reset has the same function as the Reset key on the Digital keypad. After external fault such as O.H., O.C. and O.V. are cleared, this input can be used to reset the drive.

7, 8 Multi-Step Speed Command:

Parameter values 7, 8 program these two Multi-Function Input Terminals: M1 (Pr.04-04) for multi-step speed command function.

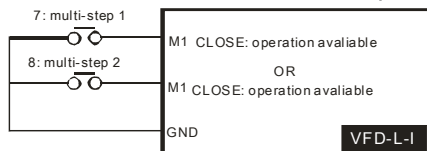

These two inputs select the multi-step speeds defined by Pr.05-00 to Pr.05-01 as shown in the following diagram. Pr.05-03 to Pr.05-07 can also control output speed by programming the AC drive's internal PLC function.

9 Jog Operation Control:

Parameter value 9 programs Multi-Function Input Terminal: M1 (Pr.04-04) for Jog control.

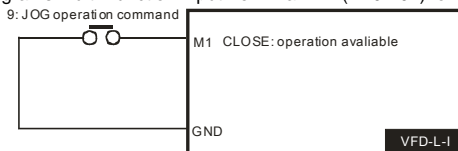

Jog operation programmed by 9 can only be initiated while the motor is stopped. It can change the operation direction during operation and stop the drive by "STOP" key on the digital keypad or external terminal (OFF) according to JOG deceleration time. (Refer to Pr.01-13, Pr.01-14, Pr.01-15.)

10 Acceleration/Deceleration Speed Inhibit:

Parameter value 10 programs Multi-Function Input Terminal: M1 (Pr.04-04) for

Acceleration/deceleration Inhibit. When the command is received, acceleration and deceleration is stopped and the AC drive maintains a constant speed. When this function is disabled, the drive will keep accel/decel. from the preset position. This command is only valid when the drive is in acceleration or deceleration.

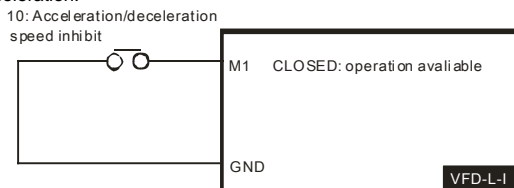

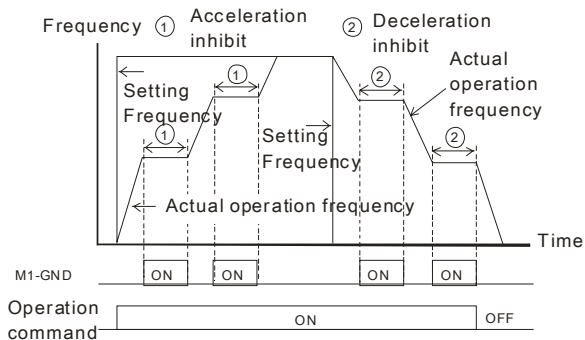

11 First or Second Acceleration/Deceleration Time Selection:

Parameter value 11 programs a Multi-Function Input Terminal: M1 (Pr.04-04) to control selection of First or Second Acceleration/deceleration time. When this terminal is OFF, the drive runs according to the acceleration/deceleration set by Pr.01-09 and Pr.01-10. When this terminal is ON, the drive runs according to the acceleration/deceleration set in Pr.01-11 and Pr.01-12. The output frequency won't be changed by the change of the switch status when the drive runs with the constant speed. The function will be obvious when the drive is accelerating/decelerating. (Refer to Pr.01-09 to Pr.01-12.)

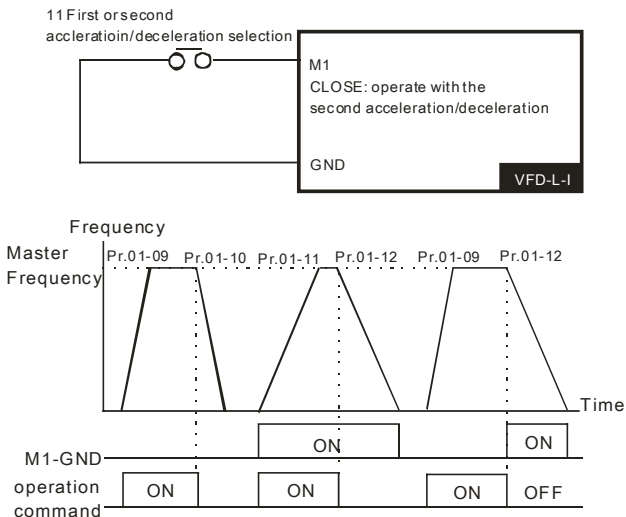

12, 13 External Base Block:

Parameter values 12, 13 program Multi-Function Input Terminals: M1 (Pr.04-04) for external Base Block control.

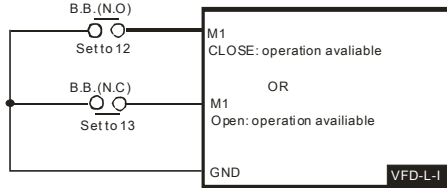

When a Base-Block signal is received, the AC drive will stop all output and the motor will free run. When base block control is deactivated, the AC drive will start its speed search function and synchronize with the motor speed, and then accelerate to Master Frequency.

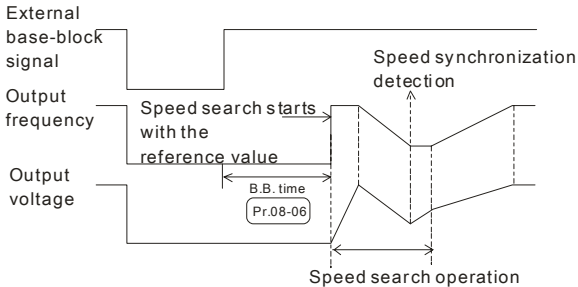
**14, 15 Increase/Decrease Master Frequency:**

Parameter values 14, 15 program the Multi-Function Input Terminals: M1 (Pr.04-04) to incrementally increase/ decrease the Master Frequency each time an input is received.

The function and operation of UP/DOWN key is almost the same as ▲▼ keys on the digital keypad. The difference is that UP/DOWN keys can't be used to change parameters. After setting frequency by the UP/DOWN key, it needs to operate with the operation command. It'll save the last frequency before power off.

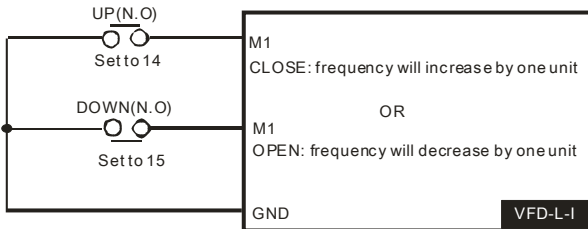

16 RUN PLC Program

17 PAUSE PLC Program

Parameter value 16 programs Multi-Function Input Terminal: M1 (Pr.04-04) to enable the AC drive internal PLC program. Parameter value 17 programs an input terminal to pause the PLC program. When this function is enabled, the output frequency of the AC motor drive will operate by parameter group 5. Refer to Pr.05-03 for details.

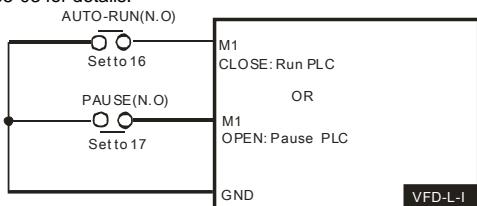

18 Counter Trigger:

Parameter value 18 programs Multi-Function Input Terminal: M1 (Pr.04-04) to increase the AC drive's internal counter. When an input is received, the counter is increased by 1. This function can be used in the counting application (winder and packaging machine) with external trigger signal, such as approximate switch and photoelectric detector, and external indication signal (count value attained and desired count value attained).

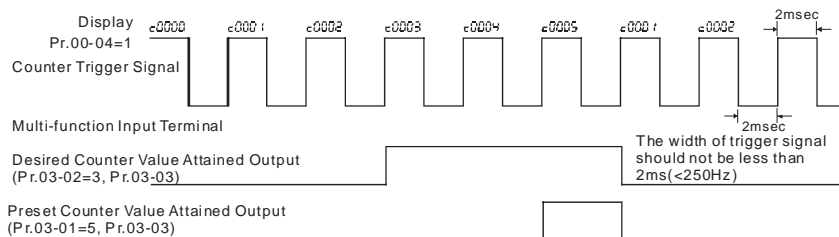
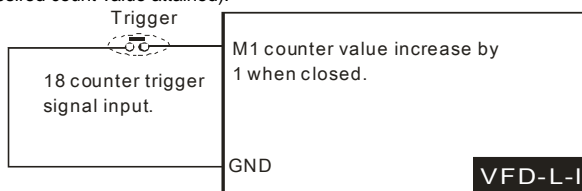

19 Counter Reset:

Parameter value 19 programs Multi-Function Input Terminal: M1 (Pr.04-04) to reset the counter.

When this function is activated, it will clear the present counter and display C0. The AC motor drive can't count until C0 disappears.

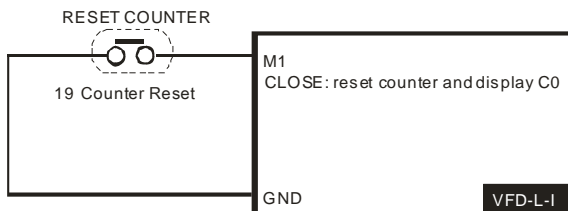

Group 5: Multi-step speeds and PLC (Process Logic Control) parameters

05-00	↗1st Step Speed Frequency	Unit: 0.01
05-01	↗2nd Step Speed Frequency	Unit: 0.01
05-02	↗3rd Step Speed Frequency	Unit: 0.01
Settings	0.00 to 400.00 Hz	Factory Setting: 0.00

 The Multi-Function Input Terminal (refer to Pr.04-04) is used to select one of the AC drive Multi-Step speeds. The speeds (frequencies) are determined by Pr.05-00 to 05-02 shown above. It can use with Pr.05-03~Pr.05-08 for PLC operation.

05-03	↗PLC Mode	Factory Setting: 0
Settings	0 Disable PLC operation	
	1 Stop after executing one program cycle	
	2 Continuously execute program cycles	
	3 Execute one program cycle step by step	
	4 Continuously execute program cycles step by step	

 This parameter selects the mode of PLC operation for the AC drive. The PLC program can be used in lieu of any External Controls, Relays or Switches. The AC drive will change speeds and directions according to the user's desired programming.

Example 1 (Pr.05-03 = 1): Execute one cycle of the PLC program. Its relative parameter settings are:

1. Pr.05-00 to 05-02: 1st to 3rd step speed (sets the frequency of each step speed).
2. Pr.04-04: Multi-Function Input Terminals (set one multi-function terminal as 16- Run PLC Program).
3. Pr.03-03: Multi-Function Output Terminals (set a Multi-Function Terminal as 10- PLC Program Running, 11- PLC Program Step Completed or 12- PLC Program Completed).
4. Pr.05-03: PLC mode.
5. Pr.05-04: Direction of operation for Master Frequency and 1st to 3rd step speed.
6. Pr.05-05 to 05-08: operation time setting of Master Frequency and 1st to 3rd step speed.

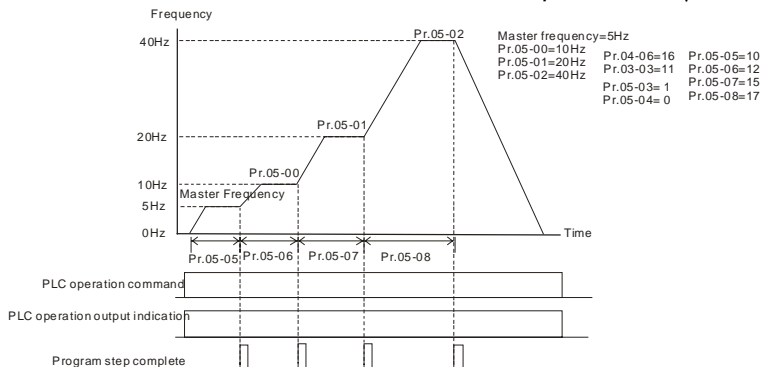
**NOTE**

The above diagram shows one complete PLC cycle. To restart the cycle, turn the PLC program off and then back on.

Example 2 (Pr.05-03 = 2): Continuously executes program cycles

The diagram below shows the PLC program stepping through each speed and the automatically starting again. To stop the PLC program, it needs to set the auto PLC command to be off.

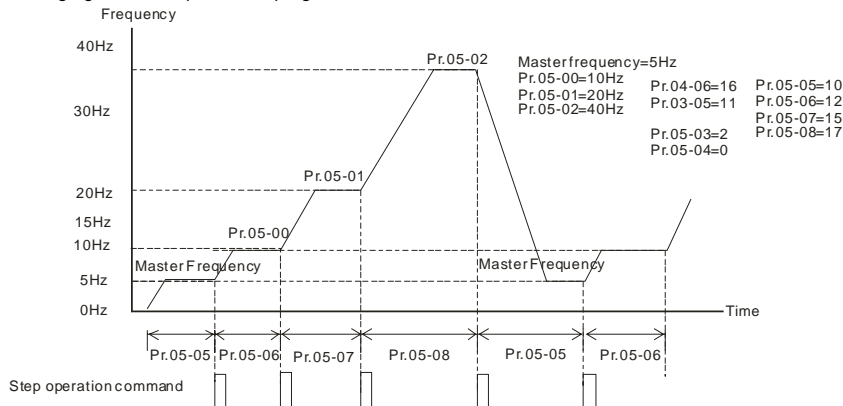

Example 3 (Pr. 05-03 = 3) Execute one cycle step by step:

The example shows how the PLC can perform one cycle at a time, within a complete cycle. Each step will use the acceleration/deceleration times. It should be noticed that the time each step spends at its intended frequency is diminished, due to the time spent during acceleration/deceleration.

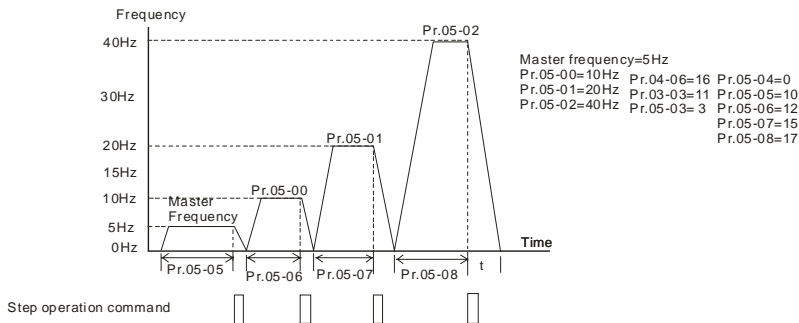

Example 4 (Pr. 05-03 =4) Continuously execute PLC cycles step by step:

The diagram below shows the PLC program stepping through each speed and stopping before restart for each step change. To stop the PLC program, it needs to set the auto PLC command to be off.

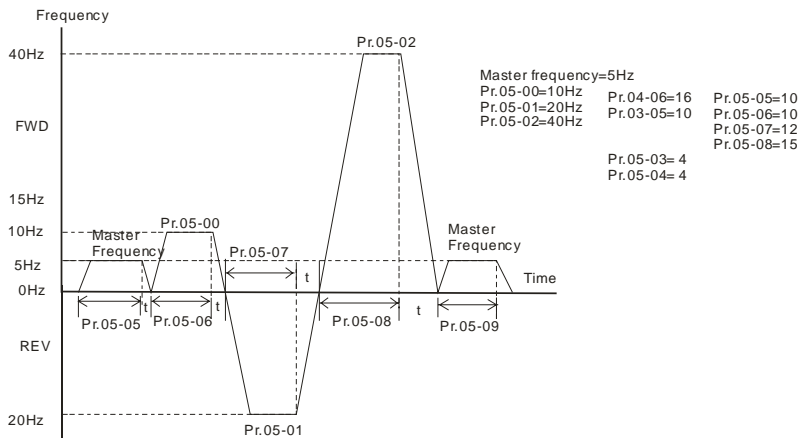

05-04 **PLC Forward/Reverse Motion**

Unit: 1

Settings 0 to 5

Factory Setting: 0

 This parameter controls the direction of motion for the Multi-Step Speed Pr.05-00 to Pr.05-03 and the Master Frequency.

 **NOTE**

The equivalent 8-bit number is used to program the forward/reverse motion. The binary notation for the 8-bit number must be translated into decimal notation and then be entered.

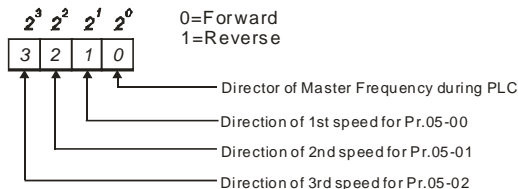

05-05	Time Duration of Zero Step Speed (corresponding parameter 02-00)	Unit: 1
--------------	-------------------------------------------------------------------------	---------

05-06	Time Duration of 1st Step Speed (corresponding parameter 05-00)	Unit: 1
--------------	------------------------------------------------------------------------	---------

05-07	Time Duration of 2nd Step Speed (corresponding parameter 05-01)	Unit: 1
--------------	------------------------------------------------------------------------	---------

05-08	Time Duration of 3rd Step Speed (corresponding parameter 05-02)	Unit: 1
--------------	------------------------------------------------------------------------	---------

Settings 0 to 65500

Factory Setting: 0

 Pr.05-05 to Pr.05-08 correspond to operation time of each multi-step speed defined by parameters 02-00 and 05-00 to 05-02. The maximum value of these parameters is 65500 sec., and it's displayed as 65.5.

 **NOTE**

If a parameter is set to "0" (0 Sec), the corresponding step will be skipped. That means though VFD-L-I series provides 4 step speeds, user can set the unnecessary step speed to 0 by his application.



Group 6: Protection Parameters

06-00**Over-Voltage Stall Prevention Level**

Unit: 1

Settings 350 to 410V (0: disable)

Factory Setting: 390

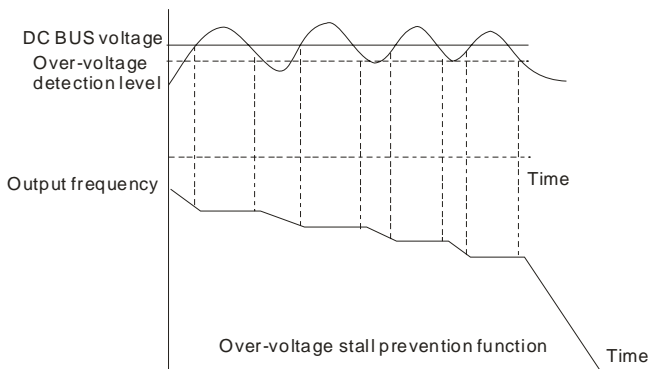

-  During deceleration, the DC bus voltage may exceed its maximum allowable value due to motor regeneration. When this function is enabled, the AC drive will stop decelerating. Maintaining a constant output frequency when it happens. The AC drive will resume deceleration when the voltage drops below preset value.
-  With a moderate inertial load, the over-voltage during deceleration won't happen, and the drive will stop in programmed time. The AC drive will automatically extend the deceleration time with high inertial loads. If deceleration time is critical for the application, then dynamic brake resistors should be used or the deceleration time should be increased.

**06-01****Over-Current Stall Prevention Level**

Unit: 1

Settings 20 to 200% (0: disable)

Factory Setting: 170

-  A setting of 100% is equal to the Rated Output Current of the drive.
-  During acceleration and steady-state operation, the AC drive output current may increase abruptly to exceed the value specified by Pr.06-01 due to rapid acceleration or excessive load on the motor. When this function is enabled, the AC drive will decrease output frequency to prevent stall. The AC drive will only resume acceleration when the current drops below the level specified by Pr. 06-01.

06-02 Over-Torque Detection Mode (OL2)

Factory Setting: 0

Settings	0	Over-Torque detection disabled.
	1	Enabled during constant speed operation. After the over-torque is detected, keep running until OL1 or OL occurs.
	2	Enabled during constant speed operation. After the over-torque is detected, stop running.
	3	Over-Torque detection enabled during running, and continues to run till OL1 or OL.
	4	Enabled during running. After the over-torque is detected, stop running.

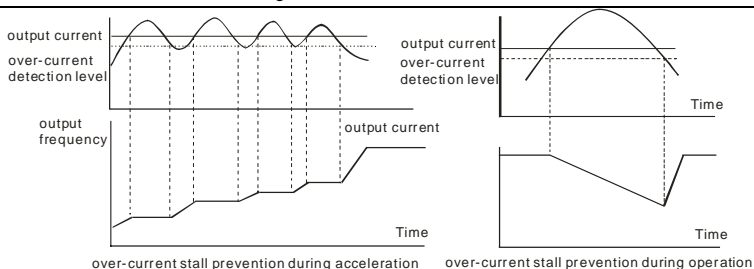
**06-03** Over-Torque Detection Level

Unit: 1

Settings 30 to 200%

Factory Setting: 150



This setting is proportional to the Rated Output Current of the drive.

06-04 Over-Torque Detection Time

Unit: 0.1

Settings 0.1 to 10.0 sec

Factory Setting: 0.1



If a Multi-function Output Terminal is set as Over-Torque Detection Indication and the output current exceeds the Over-Torque Detection Level (Pr.06-03, Factory Setting: 150%), the Over-Torque Detection Time (Pr.06-04, Factory setting: 0.1) and the setting of multi-function terminal is Over-Torque Detection Indication, the contact will be "close". Refer to Pr.03-03 for details.

06-05 Electronic Thermal Overload Relay Selection

Factory Setting: 0

Settings	0	Disabled
	1	Standard Motor
	2	Special Motor

 This function is used to protect the motor from overloading or overheating.

06-06 Electronic Thermal Characteristic

Unit: 1

Settings 30 to 600Sec

Factory Setting: 60

 The parameter determines the time required activating the I^2t electronic thermal protection function. It is used to set short time rated type, standard rated type or long time rated type.

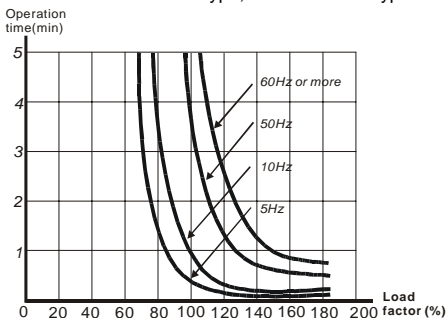
**06-07** Present Fault Record**06-08** Second Most Recent Fault Record**06-09** Third Most Recent Fault Record**06-10** Fourth Most Recent Fault Record**06-11** Fifth Most Recent Fault Record**06-12** Sixth Most Recent Fault Record

Factory Setting: 0

Readings	0	No fault
	1	Over-current (oc)
	2	Over-voltage (ov)
	3	Overheat (oH)
	4	Overload (oL)
	5	Overload1 (oL1)
	6	External fault (EF)
	7	Abnormal CPU (CF3)
	8	Protection circuit error (HPF)
	9	Current exceeds 2 times rated current during accel. (ocA)
	10	Current exceeds 2 times rated current during decel. (ocd)
	11	Current exceeds 2 times rated current during steady state operation (ocn)



Pr.06-07 to 06-12 store records of the six most recent faults that had occurred. Use the reset key to reset the drive when the fault no longer exists. These six records won't be reset to the factory setting after the drive is reset.

Group 7: Motor Parameters

07-00	↗ Motor Rated Current	Unit: 1
Settings	30 to 120%	Factory Setting: 85

 This parameter needs to be set according to the motor nameplate. The factory setting is set by the rated current of the AC motor drive. It is used to limit the AC drive output current in order to prevent the motor from overheating.

07-01	↗ Motor No-load Current	Unit: 1
Settings	0 to 90%	Factory Setting: 50

 The rated current of the AC drive is regarded as 100%. Motor setting of no-load current will effect the slip compensation. The setting value must be less than motor rated current set in Pr.07-00

07-02	↗ Torque Compensation	Unit: 1
Settings	0 to 10	Factory Setting: 1

 This parameter may be set so that the AC drive will increase its voltage output during start-up to obtain a higher initial starting torque.

07-03	↗ Slip Compensation	Unit: 0.1
Settings	0 to 10	Factory Setting: 0.0

 While driving an asynchronous motor, load on the AC drive will increase, causing an increase in slip. This parameter may be used to compensate the nominal slip within a range of 0.0 to 10.0. When the output current of the AC drive is greater than the motor no-load current (Pr.07-01), the AC drive will adjust its output frequency according to this parameter.

07-04	PID Control Mode Selection	Factory Setting: 2
--------------	----------------------------	--------------------

Settings	0	No function
	1	PID modulation of Master frequency
	2	PID modulation + master frequency shift

 Block diagram of PID control

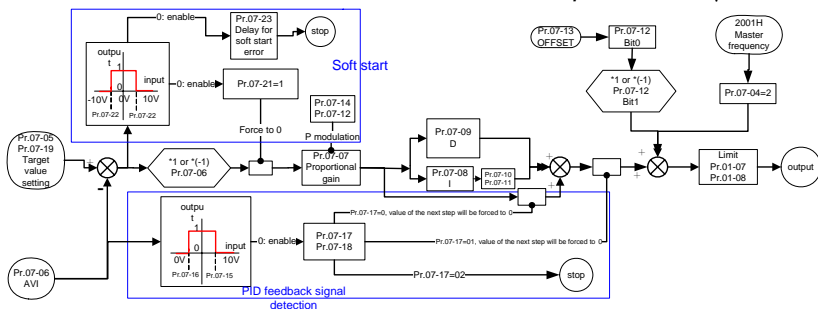

07-05 PID Set Point Selection

Factory Setting: 3

Settings	0	Reserved
	1	0 to 10V from AVI
	2	Reserved
	3	Set by Pr.07-19
	4	RS-485 communication interface

07-06 Input Terminal for PID Feedback

Factory Setting: 0

Settings	0	Positive PID feedback from external terminal (AVI) 0 to +10V
	1	Reserved
	2	Negative PID feedback from external terminal (AVI) 0 to +10V
	3	Reserved

- Select an input terminal to serve as the PID feedback location. When Pr.07-06 is set to 0 or 2, Pr.07-05 can't be set to 1.
- Negative feedback = Positive target value – detection value. It is used for the application that the detection value will be increased by increasing output frequency.
- Positive feedback = Negative target value + detection value. It is used for the application that the detection value will be decreased by increasing output frequency.

07-07 Proportional Gain (P)

Unit: 0.1

Settings 0.0 to 10.0

Factory Setting: 0.2

- This parameter is used to determinate error gain. If I = 0 and D = 0, doing proportional gain operation.

07-08	Integral Time (I)	Unit: 1
Settings	0 to 1000 (*20ms)	Factory Setting: 150

 When this parameter is defined to gain is 1 and error value is fixed, integral value is equal to error value as the setting of integral time is attained. Setting to 0 means disable this function.

07-09	Differential Control (D)	Unit: 1
Settings	0 to 20 (*20ms)	Factory Setting: 0

 When this parameter is set to gain =1, PID output is Differential time. At this time, error value –error value of the preceding item= additional respond speed and it is easy to have over compensation situation.

07-10	Upper Bound for Integral Control	Unit: 1
Settings	0 to 100%	Factory Setting: 100

 This parameter determines the Upper Bound for Integral Control while operating in the PID feedback loop. (Limit = Pr.01-00×Pr.07-10 %).

07-11	Integral Value Limit	Unit: 2 msec
		Factory Setting: 0

Settings	0	Disable
	1	Positive value only

 It is used to get the positive value of integration.

07-12	PID Extension Function	Factory Setting: 0
--------------	-------------------------------	--------------------

Settings	0 to 8
Bit 0	PID offset
Bit 1	Sign number of PID offset
Bit 2	Modulation time of proportional gain

 It needs to convert binary number to decimal number before setting this parameter.

 This parameter provides PID extension function, including PID offset, positive/negative offset value and modulation time of proportional gain.

07-13	PID Offset	Unit: 0.01
Settings	0.00 to 400.00	Factory Setting: 20.00

 It needs to set Pr.07-12 to enable this function.

07-14	Modulation Time of P	Unit: 1
Settings	0 to 1000 (*20ms)	Factory Setting: 1000

 This parameter determinates the required time for proportional gain to reach Pr.07-07 setting.
It needs to set Pr.07-12 to enable this function.

07-15	Max. Feedback Signal	Unit: 0.01
Settings	0.00 to 100.00%	Factory Setting: 80.00

 This parameter determines the max. output value of the PID feedback signal.

07-16	Min. Feedback Signal	Unit: 0.01
Settings	0.00 to 100.00%	Factory Setting: 20.00

 This parameter determines the min. output value of the PID feedback signal.

07-17	Treatment of the Erroneous Feedback Signals	Factory Setting: 1
Settings	0 difference of PID setting frequency and feedback is 0 (integral value is not changed)	
	1 difference of PID setting frequency and feedback is 0 (integral value=0)	
	2 stop the AC motor drive	

 This parameter selects the operation of the drive upon a loss of PID feedback signal.

07-18	Feedback Signal Detection Time	Unit: 1
Settings	0 to 1000(*20ms)	Factory Setting: 150

 This parameter defines the detection time for the loss of a feedback analog signal. It also can be used in the application that the system feedback signal is very slow. (setting 0.0: disable)

07-19	PID Target Value	Unit: 0.01
Settings	0.00 to 10.00V	Factory Setting: 5.00

 When Pr.07-05 is set to 3, the PID target value is the setting of Pr.07-19.

07-20	Reserved
--------------	----------

07-21	Soft Start Function
--------------	---------------------

Factory Setting: 1

Settings	0	Disable
	1	Enable

 When the deviation of target value and feedback value is less than the detection range of soft start after start-up, PID function can be activated. If the deviation of target value and feedback value is larger than the detection range of soft start after start-up, only P will be activated. PID will only be activated when the deviation of target value and feedback value is less than the detection range of soft start.

07-22	Detection Range of Soft Start
--------------	-------------------------------

Unit: 0.01

Settings	0.00 to 100.00%
----------	-----------------

Factory Setting: 0.10

 PID function will be activated when the deviation of target value and feedback value is within the detection range of soft start.

07-23	Delay for Soft Start Error
--------------	----------------------------

Unit: 1

Settings	0 to 1000 (*20ms)
----------	-------------------

Factory Setting: 1000

 The AC motor drive will stop when the deviation of target value and feedback value can't be less than the detection range of soft start(Pr.07-22) within the setting of Pr.07-23.

Group 8: Special Parameters

08-00	DC Braking Current Level	Unit: 1%
Settings	0 to 30%	Factory Setting: 0

 This parameter determines the level of DC Braking Voltage Level output to the motor during start-up and stopping. When setting DC Braking Voltage, the rated current of the AC motor drive is regarded as 100%. It is recommended to start with a low DC Braking Voltage Level and then increase until proper holding torque has been attained. It can't exceed the rated current of the motor.

08-01	DC Braking Time during Start-up	Unit: 0.1
Settings	0.0 to 60.0 sec	Factory Setting: 0.0

 This parameter determines the duration of time that the DC Braking Current will be applied to the motor during the AC drive start-up.



08-02	DC Braking Time during Stopping	Unit: 0.1
Settings	0.0 to 60.0 sec	Factory Setting: 0.0

 This parameter determines the duration of time that the DC braking voltage will be applied to the motor during stopping. If stopping with DC Braking is desired, then Pr.02-02 must be set to RAMP stop (00).

08-03	Start-Point for DC Braking	Unit: 0.1
Settings	0.0 to 400Hz	Factory Setting: 0.0

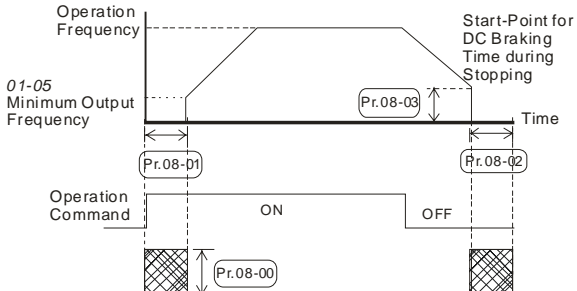
 This parameter determines the frequency when DC Braking will begin during deceleration. When this setting is less than min. frequency (Pr.01-05), the start-point for DC braking will start with the min. frequency.



-  DC Braking during Start-up is used for loads that may move before AC drive starts, such as fans and pumps. These loads may also be moving in the wrong direction. Under such circumstances, DC Braking can be executed to hold the load in position before applying a forward motion.
-  DC Braking during stopping is used to decrease stopping time and also to hold a stopped load in position. For high inertial loads, a dynamic braking resistor may be needed for quick decelerations.

08-04 Momentary Power Loss Operation Selection

Factory Setting: 0

Settings	0	Operation stops after momentary power loss
	1	Operation continues after momentary power loss, speed search starts with the Master Frequency reference value
	2	Operation continues after momentary power loss, speed search starts with the minimum frequency

08-05 Maximum Allowable Power Loss Time

Unit: 0.1



Settings	0.3 to 5.0Sec	Factory Setting: 2.0
----------	---------------	----------------------

-  During a power loss, if the power loss time is less than the time defined by this parameter, the AC drive will resume operation. If the Maximum Allowable Power Loss Time is exceeded, the AC drive output is then turned off.

08-06 Base Block Speed Search

Unit: 0.1

Settings	0.3 to 5.0Sec	Factory Setting: 0.5
----------	---------------	----------------------

-  When a momentary power loss is detected, the AC drive turns off for a specified time interval determined by Pr.08-06 before resuming operation. This time interval is called Base-Block. This parameter should be set to a value where the residual output voltage is nearly zero, before the drive resumes operation.
-  This parameter also determines the searching time when performing external Base-Block and fault reset.

08-07 Current Limit for Speed Search

Unit: 1

Settings	30 to 200%	Factory Setting: 150
----------	------------	----------------------

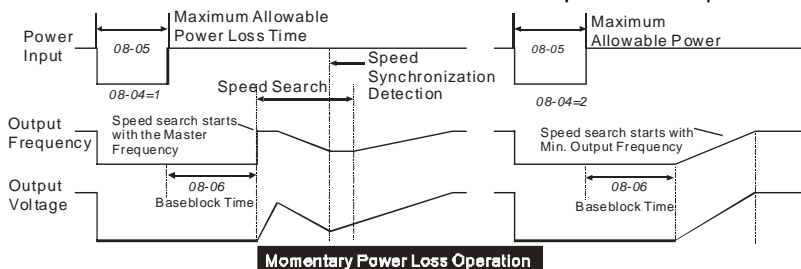

08-08	Skip Frequency 1 Upper Limit	Unit: 0.1
08-09	Skip Frequency 1 Lower Limit	Unit: 0.1
08-10	Skip Frequency 2 Upper Limit	Unit: 0.1
08-11	Skip Frequency 2 Lower Limit	Unit: 0.1
08-12	Skip Frequency 3 Upper Limit	Unit: 0.1
08-13	Skip Frequency 3 Lower Limit	Unit: 0.1
Settings		0.0 to 400Hz
		Factory Setting: 0.0

These parameters determine Skip frequency. It will cause the AC drive to skip operation at these frequency ranges with continuous frequency output.



08-14	Auto Restart After Fault	Unit: 1
Settings		0 to 10
		Factory Setting: 0

After fault occurs (allowable faults: over-current OC, over-voltage OV), the AC drive can be reset/restarted automatically up to 10 times. Setting this parameter to 0 will disable the reset/restart operation after any fault has occurred. When enabled, the AC drive will restart with speed search, which starts at the Master Frequency.

08-15	Automatic Voltage Regulation (AVR)	Factory Setting: 2
Settings		
0	AVR function enabled	
1	AVR function disabled	
2	AVR function disabled when deceleration	

The common rating for the motor is 220V/200VAC, 60Hz/50Hz, and the input voltage of the AC motor drive is 180V~264VAC 50Hz/60Hz. Without AVR function, assume that the input power of the AC motor drive is 250AC and the output voltage is also 250VAC. It will cause

motor temperature rise, poor insulation and unstable torque output when the motor exceeds 12%~20% rated voltage. In such case for a long time, it will shorten the motor life quickly.

-  AVR function automatically regulates the AC drive output voltage to the motor rated voltage. For instance, if V/f curve is set to 200VAC/50Hz and the input power is 200~264VAC, the output voltage will automatically be reduced to a max. of 200VAC. If the input voltage varying between 180 to 200VAC, the output voltage may vary between 180 to 200VAC.
-  Selecting program value 2 enables the AVR function and also disables the AVR function during deceleration. This offers a quicker deceleration.

08-16	Software Braking Level	Unit: 1
Settings	350 to 450V	Factory Setting: 380

-  During deceleration, the DC-bus voltage will increase due to motor regeneration. When DC bus voltage level exceeds the Software Braking Level, the DC brake output pins (B1, B2) will be activated.

08-17	Lower Bound of DC Braking Start-up Frequency	Unit: 0.1
Settings	0.0 to 400 Hz	Factory Setting: 0.0

-  When the setting frequency is lower than Pr.08-17, the DC Braking will not be activated when stops.

Group 9: Communication Parameters**09-00** Communication Address

Settings 1 to 247

Factory Setting: 1

 If the AC drive is controlled by RS-485 serial communication, the communication address must be set via this parameter.

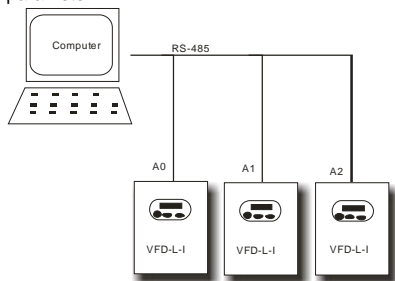
**09-01** Transmission Speed

Factory Setting: 1

Settings	0	Baud rate 4800 bps (bits / second)
	1	Baud rate 9600 bps (bits / second)
	2	Baud rate 19200 bps (bits / second)

 Users can set parameters and control the operation of the AC drive via the RS-485 serial interface of a personal computer. This parameter is used to set the transmission speed between the computer and AC drive.

09-02 Transmission Fault Treatment

Factory Setting: 0

Settings	0	Warn and keep operating
	1	Warn and RAMP to stop
	2	Warn and COAST to stop
	3	No warning and keep operating

09-03 Time-out Detection

Factory Setting: 0

Settings	0	Disable
	1	Enable

-  This setting is only valid in ASCII mode. If this function is enabled, time interval between characters can't exceed 500ms.

09-04 Communication Protocol

Factory Setting: 0

Settings	0	Modbus ASCII mode, protocol <7,N,2>
	1	Modbus ASCII mode, protocol <7,E,1>
	2	Modbus ASCII mode, protocol <7,O,1>
	3	Modbus ASCII mode, protocol <8,N,2>
	4	Modbus ASCII mode, protocol <8,E,1>
	5	Modbus ASCII mode, protocol <8,O,1>
	6	Modbus RTU mode, protocol <8,N,2>
	7	Modbus RTU mode, protocol <8,E,1>
	8	Modbus RTU mode, protocol <8,O,1>

 1. Computer Control



- 1: +EV
2: GND
3: SG-
4: SG+

Pins 1 & 2 are used for the power of digital keypad.
Please do not use it during RS-485 communication.

- ★ There is a built-in RS-485 serial interface, marked (RJ-11) on the control terminal block, for VFD-L-I Series. The pins are defined above. Each VFD-L-I AC drive has a pre-assigned communication address specified by Pr.09-00. The computer then controls each AC drive according to its communication address.
- ★ VFD-L-I can be set to communicate on Modbus networks using one of the following modes: ASCII (American Standard Code for Information Interchange) or RTU (Remote Terminal Unit). Users can select the desired mode along with the serial port communication protocol in Pr.09-04.
- ★ Code Description:

ASCII mode:

Each 8-bit data is the combination of two ASCII characters. For example, a 1-byte data:

64 Hex, shown as '64' in ASCII, consists of '6' (36Hex) and '4' (34Hex).

Character	'0'	'1'	'2'	'3'	'4'	'5'	'6'	'7'
ASCII code	30H	31H	32H	33H	34H	35H	36H	37H

Character	'8'	'9'	'A'	'B'	'C'	'D'	'E'	'F'
ASCII code	38H	39H	41H	42H	43H	44H	45H	46H

RTU mode:

Each 8-bit data is the combination of two 4-bit hexadecimal characters. For example, 64 Hex.

**2. Data Format****2.1 10-bit character frame (For 7-bit character):**

(7.N.2: Pr.09-04=0)

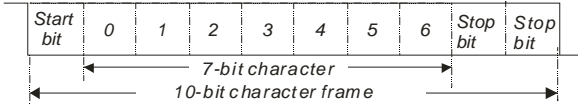

(7.E.1: Pr.09-04=1)

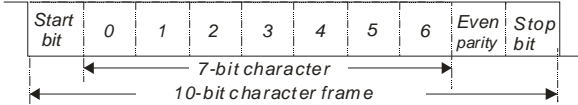

(7.O.1: Pr.09-04=2)

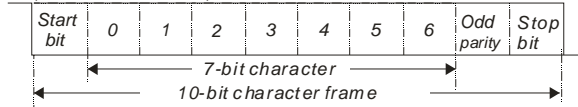
**2.2 11-bit character frame (For 8-bit character):**

(8.N.2: Pr.09-04=3 or 6)

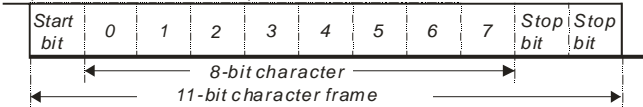

(8.E.1: Pr.09-04=4 or 7)

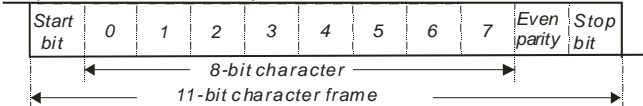

(8.O.1: Pr.09-04=5 or 8)

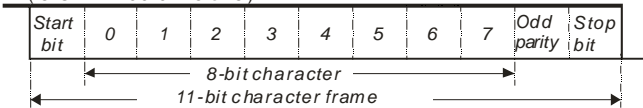
**3. Communication Protocol****3.1 Communication Data Frame:**

ASCII mode:

STX	Start character ':' (3AH)
ADR 1	Communication address:
ADR 0	8-bit address consists of 2 ASCII codes
CMD1	Command code:
CMD0	8-bit command consists of 2 ASCII codes
DATA (n-1)	Contents of data:
.....	n x 8-bit data consist of 2n ASCII codes.
DATA 0	n <= 25 , maximum of 50 ASCII codes
LRC CHK 1	LRC check sum:
LRC CHK 0	8-bit check sum consists of 2 ASCII codes
END1	End characters:
END0	END1= CR (0DH), END0= LF (0AH)

RTU mode:

START	A silent interval of more than 10 ms
ADR	Communication address: 8-bit address
CMD	Command code: 8-bit command
DATA (n-1)	Contents of data:
.....	n x 8-bit data, n<= 25
DATA 0	
CRC CHK Low	CRC check sum:
CRC CHK High	16-bit check sum consists of 2 8-bit characters
END	A silent interval of more than 10 ms

3.2 ADR (Communication Address)

Valid communication addresses are in the range of 0 to 247. A communication address equal to 0, means broadcast to all AC drives (AMD). In this case, the AMD will not reply any message to the master device.

00H: broadcast to all AC drives

01H: AC drive of address 01

0FH: AC drive of address 15

10H: AC drive of address 16

:

FEH: AC drive of address 254

For example, communication to AMD with address 16 decimal (10H):

ASCII mode: Address='1','0' => '1'=31H, '0'=30H

RTU mode: Address=10H

3.3 CMD (Command code) and DATA (data characters)

The format of data characters depends on the command code. The available command codes are described as followed:

(1) Command code: 03H, read N words.

The maximum value of N is 12. For example, reading continuous 2 words from starting address 2102H of AMD with address 01H.

ASCII mode:

Command message:

STX	':'
ADR 1	'0'
ADR 0	'1'
CMD 1	'0'
CMD 0	'3'
Starting data address	'2'
	'1'
	'0'
	'2'
Number of data (count by word)	'0'
	'0'
	'0'
	'2'
LRC CHK 1	'D'
LRC CHK 0	'7'
END 1	CR
END 0	LF

Response message:

STX	':'
ADR 1	'0'
ADR 0	'1'
CMD 1	'0'
CMD 0	'3'
Number of data (Count by byte)	'0'
	'4'
Content of starting address 2102H	'1'
	'7'
	'7'
	'0'
Content of address 2103H	'0'
	'0'
	'0'
	'0'
LRC CHK 1	'7'
LRC CHK 0	'1'
END 1	CR
END 0	LF

RTU mode:

Command message:

ADR	01H
CMD	03H
Starting data address	21H
	02H
Number of data (count by word)	00H
	02H
CRC CHK Low	6FH
CRC CHK High	F7H

Response message:

ADR	01H
CMD	03H
Number of data (count by byte)	04H
Content of address 2102H	17H
	70H
Content of address 2103H	00H
	00H
CRC CHK Low	FEH
CRC CHK High	5CH

(2) 06H: single write, write single data to register.

Example: writing data 6000(1770H) to register 0100H. AMD address is 01H.

ASCII mode:

Command message:	
STX	'.'
ADR 1	'0'
ADR 0	'1'
CMD 1	'0'
CMD 0	'6'
Data address	'0'
	'1'
	'0'
	'0'
Data content	'1'
	'7'
	'7'
	'0'
LRC CHK 1	'7'
LRC CHK 0	'1'
END 1	CR
END 0	LF

Response message:	
STX	'.'
ADR 1	'0'
ADR 0	'1'
CMD 1	'0'
CMD 0	'6'
Data address	'0'
	'1'
	'0'
	'0'
Data content	'1'
	'7'
	'7'
	'0'
LRC CHK 1	'7'
LRC CHK 0	'1'
END 1	CR
END 0	LF

RTU mode:

Command message:	
ADR	01H
CMD	06H
Data address	01H
	00H
Data content	17H
	70H
CRC CHK Low	86H
CRC CHK High	22H

Response message:	
ADR	01H
CMD	06H
Data address	01H
	00H
Data content	17H
	70H
CRC CHK Low	86H
CRC CHK High	22H

3.4 Check sum

ASCII mode:

LRC (Longitudinal Redundancy Check) is calculated by summing up, module 256, the values of the bytes from ADR1 to last data character then calculating the hexadecimal representation of the 2's-complement negation of the sum.

For example, reading 1 word from address 0401H of the AC drive with address 01H

STX	'.'
ADR 1	'0'
ADR 0	'1'
CMD1	'0'
CMD0	'3'
Starting data address	'0'
	'4'
	'0'
	'1'
Number of data	'0'
	'0'
	'0'
	'1'
LRC CHK 1	'F'
LRC CHK 0	'6'
END1	CR
END0	LF

01H+03H+04H+01H+00H+01H=0AH, the 2's-complement negation of 0AH is **F6H**.

RTU mode:

CRC (Cyclical Redundancy Check) is calculated by the following steps:

Step 1: Load a 16-bit register (called CRC register) with FFFFH.

Step 2: Exclusive OR the first 8-bit byte of the command message with the low order byte of the 16-bit CRC register, putting the result in the CRC register.

Step 3: Examine the LSB of CRC register.

Step 4: If the LSB of CRC register is 0, shift the CRC register one bit to the right with MSB zero filling, then repeat step 3. If the LSB of CRC register is 1, shift the CRC register one bit to the right with MSB zero filling, Exclusive OR the CRC register with the polynomial value A001H, then repeat step 3.

Step 5: Repeat step 3 and 4 until eight shifts have been performed. When this is done, a complete 8-bit byte will have been processed.

Step 6: Repeat step 2 to 5 for the next 8-bit byte of the command message. Continue doing this until all bytes have been processed. The final contents of the CRC register are the CRC value. When transmitting the CRC value in the message, the upper and lower bytes of the CRC value must be swapped, i.e. the lower order byte will be transmitted first.

For example, reading 2 words from address 2102H of the AC drive with address 01H.

ADR	01H
CMD	03H
Starting address	21H
	02H
Number of data (count by word)	00H
	02H
CRC CHK Low	6FH
CRC CHK High	F7H

The following is an example of CRC generation using C language. The function takes two arguments:

Unsigned char* data ← a pointer to the message buffer

Unsigned char length ← the quantity of bytes in the message buffer

The function returns the CRC value as a type of unsigned integer.

Unsigned int crc_chk(unsigned char* data, unsigned char length){

int j;

unsigned int reg_crc=0xFFFF;

while(length--){

reg_crc ^= *data++;

for(j=0;j<8;j++){

if(reg_crc & 0x01){ /* LSB(b0)=1 */

reg_crc=(reg_crc>>1) ^ 0xA001;

}else{

reg_crc=reg_crc >>1;

}

}

}

return reg_crc;

}

3.5 Address list

The contents of available addresses are shown as below:

Content	Address	Functions
AC drive Parameters	ggnnH	gg means parameter group, nn means parameter number, for example, the address of Pr.04-01 is 0401H. Referencing to chapter 5 for the function of each parameter. When reading parameter by command code 03H, only one parameter can be read at one time.

Content	Address	Functions	
Read	0BnnH	Max. number of each parameter group, nn means parameter group. For example, 0B00H will return the max. parameter number of group 0.	
Command	2000H	Bit 0-1	00: No function 01: Stop 10: Run 11: Jog + Run
		Bit 2-3	Not used
		Bit 4-5	00: No function 01: FWD 10: REV 11: Change direction
		Bit 6-15	Not used
	2001H	Freq. command	
	2002H	Bit 0	1: EF (external fault) on
		Bit 1	1: Reset
		Bit 2-15	Not used
Status monitor Read only	2100H	Error code: 0: No errors occurred 1: Over-current (oc) 2: Over-voltage (ov) 3: Overheat (oH) 4: Overload (oL) 5: Overload1 (oL1) 6: External fault (EF) 7: Reserved 8: Reserved 9: Current exceeds 2 times rated current during acceleration (ocA) 10: Current exceeds 2 times rated current during deceleration (ocd) 11: Current exceeds 2 times rated current during steady state operation (ocn) 12: Reserved 13: Reserved 14: Low voltage (Lv) 15: CPU failure 1 (cF1) 16: CPU failure 2 (cF2) 17: Base block 18: Overload (oL2) 19: Auto acceleration/deceleration failure (cFA) 20: Software protection enable (codE) 21: Reserved 22: CPU failure (cF3.1) 23: CPU failure (cF3.2) 24: CPU failure (cF3.3) 25: CPU failure (cF3.4) 26: CPU failure (cF3.5) 27: CPU failure (cF3.6) 28: CPU failure (cF3.7) 29: Hardware protection failure (HPF.1) 30: Hardware protection failure (HPF.2) 31: Hardware protection failure (HPF.3)	

Content	Address	Functions
		32: CE 10 33: Reserved 34: Software error (BRK, ZDIV) 35: EEPROM read time out
	2101H	Status of AC Drive
	Bit 0-1	00: RUN LED light off, STOP LED light up 01: RUN LED blink, STOP LED light up 10: RUN LED light up, STOP LED blink 11: RUN LED light up, STOP LED light off
	Bit 2	01: Jog active
	Bit 3-4	00: REV LED light off, FWD LED light up 01: REV LED blink, FWD LED light up 10: REV LED light up, FWD LED blink 11: REV LED light up, FRD LED light off
	Bit 5	1: Invisible parameter can be read
	Bit 6-7	Not used
	Bit 8	1: Main freq. Controlled by communication
	Bit 9	1: Main freq. Controlled by external terminal
	Bit 10	1: Operation command controlled by communication
	Bit 11	1: Parameters have been locked
	Bit 12-15	Not Used
	2102H	Frequency command F (XXX.XX)
	2103H	Output Frequency H (XXX.XX)
	2104H	Output Current A (XXX.XX)
	2105H	DC-BUS Voltage U (XXX.XX)
	2106H	Output Voltage E (XXX.XX)
	2107H	Step number of Multi-Step Speed Operation
	2108H	Step number of PLC operation
	2109H	Time of PLC Operation
	210AH	Counter Value
	210BH	User-defined
	210CH	User-defined unit. 0: no decimal, 1: two decimal digits
	2110H	Model type, high byte=1, low byte=6
	2111H	Max. parameter group number
	2112H	Parameter is locked with password

3.6 Exception response:

The AC motor drive is expected to return a normal response after receiving command messages from the master device. The following depicts the conditions when no normal response is replied to the master device.

The AC motor drive does not receive the messages due to a communication error; thus, the AC motor drive has no response. The master device will eventually process a timeout condition.

The AC motor drive receives the messages without a communication error, but cannot handle them. An exception response will be returned to the master device and an error message "CExx" will be displayed on the keypad of AC motor drive. The xx of "CExx" is a decimal code equal to the exception code that is described below.

In the exception response, the most significant bit of the original command code is set to 1, and an exception code which explains the condition that caused the exception is returned.

Example of an exception response of command code 06H and exception code 02H:

ASCII mode:		RTU mode:	
STX	0x02	ADR	01H
ADR 1	'0'	CMD	86H
ADR 0	'1'	Exception code	02H
CMD1	'8'	CRC CHK Low	C3H
CMD0	'6'	CRC CHK High	A1H
Exception code	'0'		
	'2'		
LRC CHK 1	'7'		
LRC CHK 0	'7'		
END1	CR		
END0	LF		

The explanation of exception codes:

Exception code	Meaning
1	Illegal command code: The command code received in the command message is not available for the AC drive.
2	Illegal data address: The data address received in the command message is not available for the AC drive.
3	Illegal data value: The data value received in the command message is not available for the AC drive.
4	Slave device failure: The AC drive is unable to perform the requested action.

The AC drive receives the messages, but detects a communication error, thus, no response is returned, but there will be error message "CExx" displayed on the keypad of AC drive. The master device will eventually process a timeout condition. The xx of "CExx" is a decimal code, the meaning of the error message is below:

Error message	Meaning
5	Reserved
6	AC drive busy: The time interval between commands is too short. Please keep an interval of 10ms at least after the return of a command. If no command returned, please keep a 10ms interval at least for the same reason.
7	Reserved
8	Reserved
9	Check Sum Error: Check if the Check Sum is correct.
10	Time-out (only for ASCII mode): the interval should not exceed 500ms except timeless detection.
11	Frame Error: Check if the Baud rate complies with the data format.
12	The command message is too short.
13	Command message length is out of range.
14	The command messages include the data that does not belong to '0' to '9', 'A' to 'F' except starting and end character (only for Modbus ASCII mode).

3.7 Communication program of PC:

The following is a simple example of how to write a communication program for Modbus ASCII mode on a PC in C language.

```
#include<stdio.h>
#include<dos.h>
#include<conio.h>
#include<process.h>
#define PORT 0x03F8 /* the address of COM1 */
/* the address offset value relative to COM1 */
#define THR 0x0000
#define RDR 0x0000
#define BRDL 0x0000
#define IER 0x0001
#define BRDH 0x0001
#define LCR 0x0003
#define MCR 0x0004
#define LSR 0x0005
#define MSR 0x0006
unsigned char rdat[60];
/* read 2 data from address 2102H of AC drive with address 1 */
unsigned char tdat[60]={':', '0', '1', '0', '3', '2', '1', '0', '2', '0', '0', '0', '2', 'D', '7', '\r', '\n'};
void main(){int i;
outputb(PORT+MCR,0x08); /* interrupt enable */
outputb(PORT+IER,0x01); /* interrupt as data in */
outputb(PORT+LCR,(inportb(PORT+LCR) | 0x80));
/* the BRDL/BRDH can be access as LCR.b7==1 */
outputb(PORT+BRDL,12); /* set baudrate=9600, 12=115200/9600*/
outputb(PORT+BRDH,0x00);
outputb(PORT+LCR,0x06); /* set protocol, <7,N,2>=06H, <7,E,1>=1AH, <7,O,1>=0AH,
<8,N,2>=07H, <8,E,1>=1BH, <8,O,1>=0BH */
for(i=0;i<=16;i++){
while(!(inportb(PORT+LSR) & 0x20)); /* wait until THR empty */
outputb(PORT+THR,tdat[i]); /* send data to THR */ }
i=0;
while(!kbhit()){
if(inportb(PORT+LSR) & 0x01){ /* b0==1, read data ready */
rdat[i++]=inportb(PORT+RDR); /* read data form RDR */
} } }
```

Chapter 5 Fault Code Information

The AC motor drive has a comprehensive fault diagnostic system that includes several different alarms and fault messages. Once a fault is detected, the corresponding protective functions will be activated. The following faults are displayed as shown on the AC motor drive digital keypad display. The three most recent faults can be read from the digital keypad or communication.



Wait 5 seconds after a fault has been cleared before pressing RESET key.

5.1 Common Problems and Solutions

Fault Name	Fault Descriptions	Corrective Actions
OC	Over current Abnormal increase in current.	<ol style="list-style-type: none">1. Check if motor power corresponds with the AC motor drive output power.2. Check the wiring connections to U/T1, V/T2, W/T3 for possible short circuits.3. Check the wiring connections between the AC motor drive and motor for possible short circuits, also to ground.4. Check for loose contacts between AC motor drive and motor.5. Increase the Acceleration Time (Pr.01-09, 01-11)6. Check for possible excessive loading conditions at the motor.
OU	Over voltage The DC bus voltage has exceeded its maximum allowable value.	<ol style="list-style-type: none">1. Check if the input voltage falls within the rated AC motor drive input voltage range.2. Check for possible voltage transients.3. DC-bus over-voltage may also be caused by motor regeneration. Either increase the Decel. Time or add an optional brake resistor.
OH	Overheating Heat sink temperature too high	<ol style="list-style-type: none">1. Ensure that the ambient temperature falls within the specified temperature range.2. Remove any foreign objects from the heatsinks and check for possible dirty heat sink fins.3. Provide enough spacing for adequate ventilation.
HPF	Protection circuit error (HPF.1, HPF.2, HPF.3)	Return to the factory

Fault Name	Fault Descriptions	Corrective Actions
LU	Low voltage The AC motor drive detects that the DC bus voltage has fallen below its minimum value.	<ol style="list-style-type: none"> 1. Check whether the input voltage falls within the AC motor drive rated input voltage range. 2. Check for abnormal load in motor. 3. Check for correct wiring of input power to R-S-T (for 3-phase models) without phase loss.
code	Software protection failure	Return to the factory.
OL	Overload The AC motor drive detects excessive drive output current. NOTE: The AC motor drive can withstand up to 150% of the rated current for a maximum of 60 seconds.	<ol style="list-style-type: none"> 1. Check whether the motor is overloaded. 2. Reduce torque compensation setting in Pr.07-02 3. Use the next higher power AC motor drive model.
OL1	Overload 1 Internal electronic overload trip	<ol style="list-style-type: none"> 1. Check for possible motor overload. 2. Check electronic thermal overload setting. 3. Use a higher power motor. 4. Reduce the current level so that the drive output current does not exceed the value set by the Motor Rated Current Pr.07-00.
OL2	Overload 2 Motor overload.	<ol style="list-style-type: none"> 1. Reduce the motor load. 2. Adjust the over-torque detection setting to an appropriate setting (Pr.06-03 to Pr.06-05).
OCN	Over-current during constant speed operation	<ol style="list-style-type: none"> 1. Short-circuit at motor output: Check for possible poor insulation at the output line. 2. Check if the motor is obstructed. 3. AC motor drive output power is too small: Replace the AC motor drive with the next higher power model.
CE1	Abnormal communication	<ol style="list-style-type: none"> 1. Check if the connection between SG+ and SG- 2. Check if the communication format is correct.
OCA	Over-current during acceleration	<ol style="list-style-type: none"> 1. Check for the loose screws between the AC motor drive and motor 2. Short-circuit at motor output: Check for possible poor insulation at the output lines. 3. Acceleration Time too short: Increase the Acceleration Time. 4. Torque boost too high: Decrease the torque compensation setting in Pr.07-02 5. AC motor drive output power is too small: Replace the AC motor drive with the next higher power model.
OCD	Over-current during deceleration	<ol style="list-style-type: none"> 1. Short-circuit at motor output: Check for possible poor insulation at the output line. 2. Deceleration Time too short: Increase the Deceleration Time. 3. AC motor drive output power is too small: Replace the AC motor drive with the next higher power model.

Fault Name	Fault Descriptions	Corrective Actions
EF	External Fault	<ol style="list-style-type: none"> When multi-function input terminals (M0-M1) are set to external fault, the AC motor drive stops output U, V and W. Give RESET command after fault has been cleared.
cF1	Internal EEPROM can not be written.	Return to the factory.
cF2	Internal EEPROM can not be read	<ol style="list-style-type: none"> Press RESET key to reset all parameters to the factory settings. Return to the factory.
cF3	Drive's internal circuitry abnormal (CF3.1~CF3.7)	Return to the factory.
bb	External Base Block	<ol style="list-style-type: none"> When the external input terminal (B.B) is active, the AC motor drive output will be turned off. Deactivate the external input terminal (B.B) to operate the AC motor drive again.
cFA	Auto Accel/decel Failure	<ol style="list-style-type: none"> Check if the motor is suitable for operation by AC motor drive. Check if the regenerative energy is too large. Load may have changed suddenly.

This page intentionally left blank

6.1 Over Current (OC)

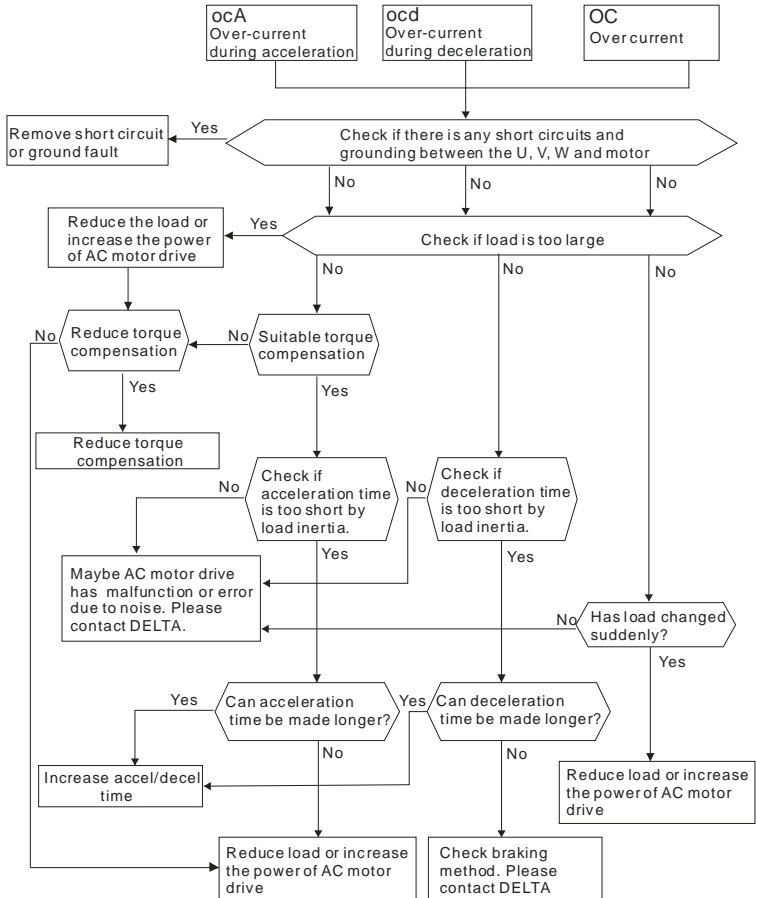

6.2 Over Voltage (OV)

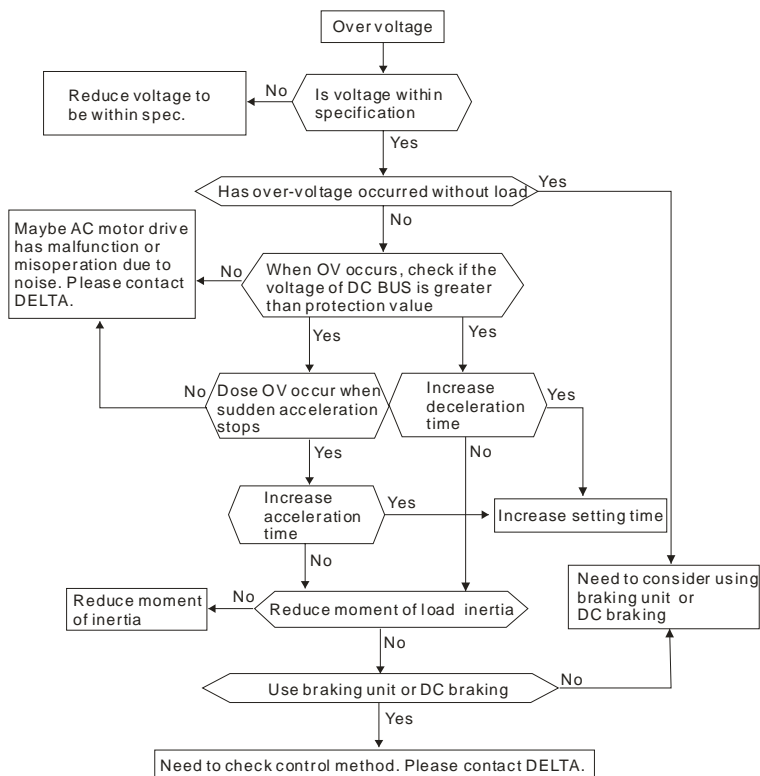

6.3 Low Voltage (Lv)

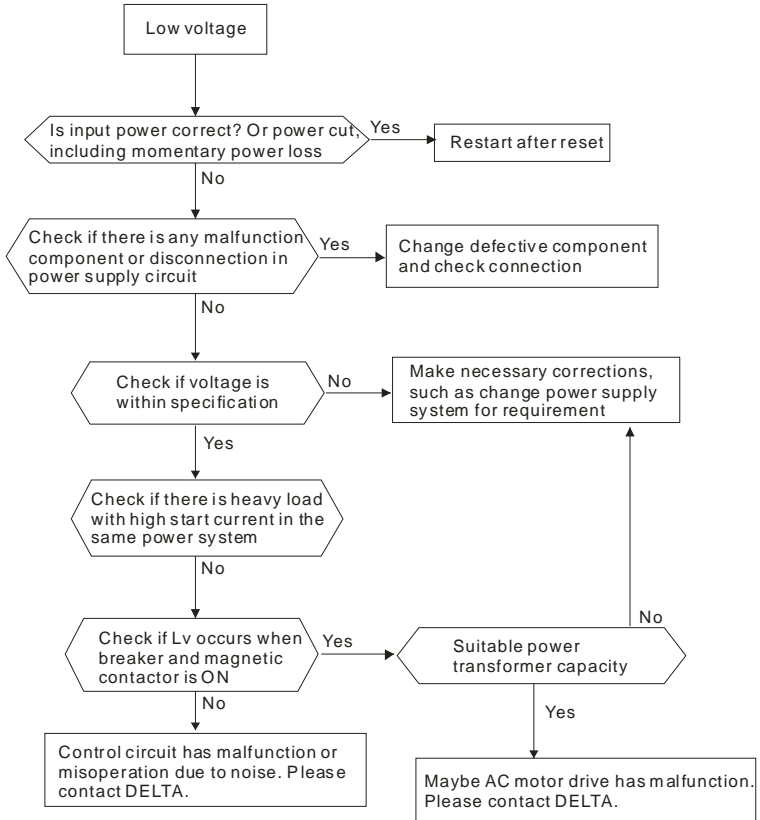

6.4 Over Heat (OH)

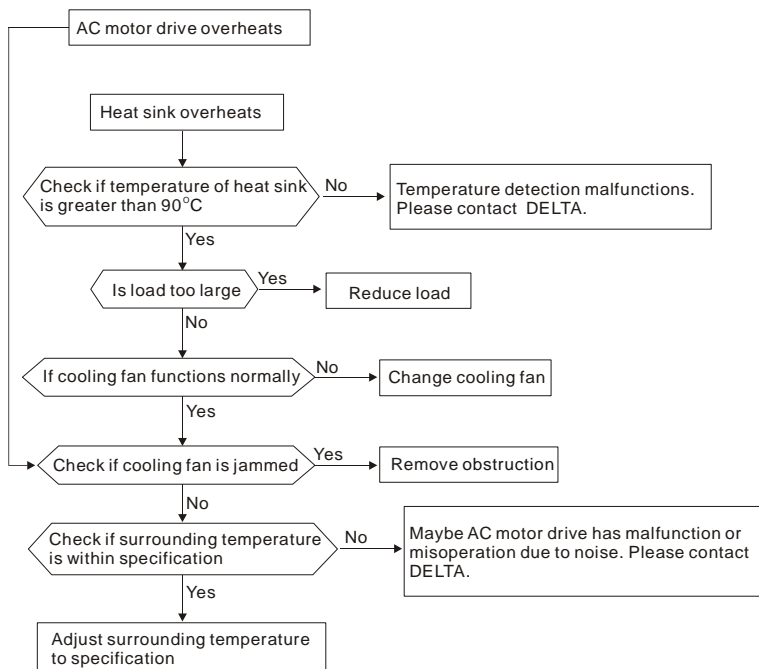

6.5 Overload

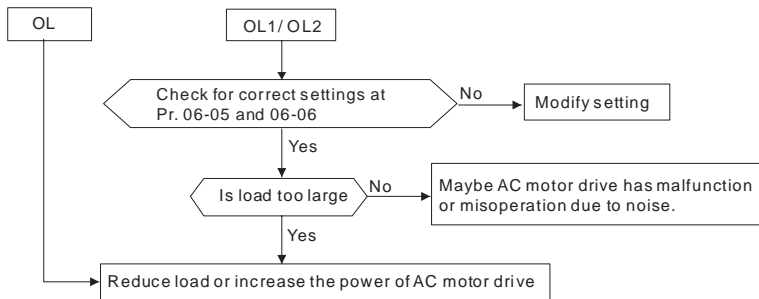

6.6 Motor Stalls during Acceleration

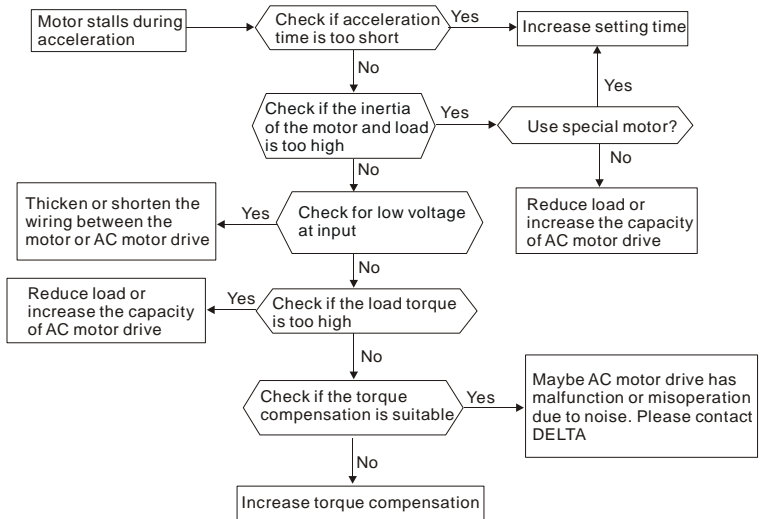

6.7 The Motor does not Run as Expected

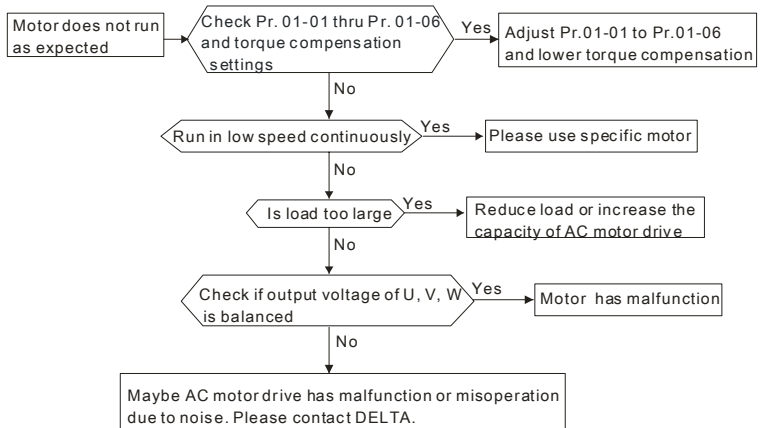

This page intentionally left blank

Chapter 7 Maintenance and Inspections

Modern AC motor drives are based on solid-state electronics technology. Preventive maintenance is required to keep the AC motor drive in its optimal condition, and to ensure a long life. It is recommended to have a qualified technician perform a check-up of the AC motor drive regularly.

Daily Inspection:

Basic check-up items to detect if there were any abnormalities during operation are:

1. Whether the motors are operating as expected.
2. Whether the installation environment is abnormal.
3. Whether the display of the digital keypad is normal.
4. Whether any irregular vibration or sound occurred during operation.
5. Whether the motors are overheating during operation.

Periodic Inspection:

Before the check-up, always turn off the AC input power and remove the cover. Wait at least 10 minutes after all display lamps have gone out, and then confirm that the capacitors have fully discharged by measuring the voltage between \oplus ~ \ominus . It should be less than 25VDC.



1. Disconnect AC power before processing!
2. Only qualified personnel shall install, wire and maintain AC motor drives. Please take off any metal objects, such as watches and rings, before operation. And only insulated tools are allowed.
3. Never reassemble internal components or wiring.
4. Prevent electric shocks.

Periodical Maintenance

■ Ambient environment

Check Items	Methods and Criterion	Maintenance Period		
		Daily	Half Year	One Year
Check the ambient temperature, humidity, vibration and see if there is any dust, gas, oil or water drops	Visual inspection and measurement with equipment with standard specification	○		
Check for any dangerous objects near drive and motor	Visual inspection	○		

■ Voltage

Check Items	Methods and Criterion	Maintenance Period		
		Daily	Half Year	One Year
Check if the voltage of main circuit and control circuit is correct	Measure with multimeter with standard specification	○		

■ Keypad

Check Items	Methods and Criterion	Maintenance Period		
		Daily	Half Year	One Year
Is the display clear for reading?	Visual inspection	○		
Any missing characters?	Visual inspection	○		

■ Mechanical parts

Check Items	Methods and Criterion	Maintenance Period		
		Daily	Half Year	One Year
If there is any abnormal sound or vibration	Visual and aural inspection		○	
If there are any loose screws	Tighten the screws		○	

Check Items	Methods and Criterion	Maintenance Period		
		Daily	Half Year	One Year
Check parts for deformity or damaged	Visual inspection		○	
If there is any color change caused by overheating	Visual inspection		○	
Check for dust and dirt	Visual inspection		○	

■ **Main circuit**

Check Items	Methods and Criterion	Maintenance Period		
		Daily	Half Year	One Year
If there are any loose or missing screws	Tighten or replace the screw	○		
If machine or insulator is deformed, cracked, damaged or with changed color change due to overheating or ageing	Visual inspection NOTE: Please ignore the color change of copper plate		○	
Check for dust and dirt	Visual inspection		○	

■ **Terminals and wiring of main circuit**

Check Items	Methods and Criterion	Maintenance Period		
		Daily	Half Year	One Year
If the wiring shows change of color change or deformation due to overheat	Visual inspection		○	
If the insulation of wiring is damaged or the color has changed	Visual inspection		○	
If there is any damage	Visual inspection		○	

■ **DC capacity of main circuit**

Check Items	Methods and Criterion	Maintenance Period		
		Daily	Half Year	One Year
If there is any leakage of liquid, change of color, cracks or deformation	Visual inspection	○		
Measure static capacity when required	Static capacity \geq initial value X 0.85	○		

■ **Resistor of main circuit**

Check Items	Methods and Criterion	Maintenance Period		
		Daily	Half Year	One Year
If there is any peculiar smell or insulator cracks due to overheating	Visual inspection, smell	○		
If there is any disconnection	Visual inspection or measure with multimeter	○		

■ **Transformer and reactor of main circuit**

Check Items	Methods and Criterion	Maintenance Period		
		Daily	Half Year	One Year
If there is any abnormal vibration or peculiar smell	Visual, aural inspection and smell	○		

■ **Magnetic contactor and relay of main circuit**

Check Items	Methods and Criterion	Maintenance Period		
		Daily	Half Year	One Year
If there are any loose screws	Visual and aural inspection. Tighten screw if necessary.	○		
Check to see if contacts work correctly	Visual inspection	○		

■ **Printed circuit board and connector of main circuit**

Check Items	Methods and Criterion	Maintenance Period		
		Daily	Half Year	One Year
If there are any loose screws and connectors	Tighten the screws and press the connectors firmly in place.		○	
If there is any peculiar smell and color change	Visual inspection and smell		○	
If there is any crack, damage, deformation or corrosion	Visual inspection		○	
If there is any leaked liquid or deformation in capacitors	Visual inspection		○	

■ **Cooling fan of cooling system**

Check Items	Methods and Criterion	Maintenance Period		
		Daily	Half Year	One Year
If there is any abnormal sound or vibration	Visual, aural inspection and turn the fan with hand (turn off the power before operation) to see if it rotates smoothly		○	
If there is any loose screw	Tighten the screw		○	
If there is any change of color due to overheating	Change fan		○	

■ **Ventilation channel of cooling system**

Check Items	Methods and Criterion	Maintenance Period		
		Daily	Half Year	One Year
If there is any obstruction in the heat sink, air intake or air outlet	Visual inspection		○	

This page intentionally left blank

Appendix A Specifications

Voltage Class		230V Class
Model Number VFD-XXXL21B-I		002
Max. Applicable Motor Output (kW)		0.2
Max. Applicable Motor Output (HP)		0.25
Output Rating	Rated Output Capacity (KVA)	0.6
	Rated Output Current (A)	1.6
Maximum Output Voltage (V)		3-phase Proportional to Input Voltage
Rated Frequency (Hz)		1.0 to 400 Hz
Input Rating	Rated Input Current (A)	4.9
	Rated Voltage/Frequency	1-phase 180-264V 50/60Hz
	Voltage Tolerance	±10% (180~264V)
	Frequency Tolerance	±5% (47~63Hz)
Cooling Method		Natural air-cooling
Control Characteristics	Control System	
	SPWM (Sinusoidal Pulse Width Modulation, carrier frequency 3k-10kHz)	
	Output Frequency Resolution	
	0.1Hz	
	Torque Characteristics	
	Including the auto-torque, auto-slip compensation; starting torque can be 150% at 5Hz	
Overload Endurance		
150% of rated current for 1 minute		
Accel/Decel Time		
0.1to 600 second (2 Independent settings for Accel/Decel Time)		
V/f Pattern		
V/f pattern adjustable		
Stall Prevention Level		
20 to 200%, Setting of Rated Current		
Operating Characteristics	Frequency Setting	External Signal
	Operation Setting Signal	External Signal
	Multi-Function Input Signal	
	Multi-Function Output Indication	
Other Function		
Protection		
Environment	Installation Location	Altitude 1,000 m or below, keep from corrosive gasses, liquid and dust
	Ambient Temperature	-10°C to 50°C (Non-Condensing and not frozen)
	Storage Temperature	-20°C to 60°C
	Ambient Humidity	Below 90% RH (non-condensing)
	Vibration	9.80665m/s ² (1G) less than 20Hz, 5.88m/s ² (0.6G) at 20 to 50Hz
Others		Built-in EMI filter

This page intentionally left blank

Appendix B Accessories

B.1 Remote Controller RC-01

(Dimensions are in millimeter)

	Model Name	Note
Remote controller (without wire)	RC-01	It needs to use shield wire.

