

**M-D**

# VFD-M-D

## User Manual

Specific AC Motor Drives for the Elevator Door



**Voltage Range:**  
1-phase 230V series:0.4kW



DELTA ELECTRONICS, INC.

[www.delta.com.tw/industrialautomation](http://www.delta.com.tw/industrialautomation)

## **ASIA**

### **Delta Electronics, Inc.**

#### **Taoyuan1**

31-1, Xingbang Road, Guishan Industrial Zone,  
Taoyuan County 33370, Taiwan, R.O.C.  
TEL: 886-3-362-6301 / FAX: 886-3-362-7267

### **Delta Electronics (Jiang Su) Ltd.**

#### **Wujiang Plant3**

1688 Jiangxing East Road,  
Wujiang Economy Development Zone,  
Wujiang City, Jiang Su Province,  
People's Republic of China (Post code: 215200)  
TEL: 86-512-6340-3008 / FAX: 86-512-6340-7290

### **Delta Electronics (Japan), Inc.**

#### **Tokyo Office**

Delta Shibadaimon Building, 2-1-14 Shibadaimon,  
Minato-Ku, Tokyo, 105-0012, Japan  
TEL: 81-3-5733-1111 / FAX: 81-3-5733-1211

### **Delta Electronics (Korea), Inc.**

234-9, Duck Soo BD 7F, Nonhyun-dong,  
Kangnam-ku, Seoul, Korea  
Post code : 135-010  
TEL: 82-2-515-5303/5 / FAX: 82-2-515-5302

### **Delta Electronics (Singapore) Pte. Ltd.**

8 Kaki Bukit Road 2, #04-18 Ruby Warehouse Complex,  
Singapore 417841  
TEL: 65-6747-5155 / FAX: 65-6744-9228

### **Delta Energy Systems (India) Pvt. Ltd.**

Plot No. 27 & 31, Sector-34, EHTP,  
Gurgaon-122001 Haryana, India  
TEL: 91-124-4169040 / FAX: 91-124-4036045

## **AMERICA**

### **Delta Products Corporation (USA)**

#### **Raleigh Office**

P.O. Box 12173, 5101 Davis Drive,  
Research Triangle Park, NC 27709, U.S.A.  
TEL: 1-919-767-3813 / FAX: 1-919-767-3969

## **EUROPE**

### **Deltronics (Netherlands) B.V.**

#### **Eindhoven Office**

De Witbogt 15, 5652 AG Eindhoven, The Netherlands  
TEL: 31-40-259-28-50/ FAX: 31-40-259-28-51

5011642405  
200905-06



MDE5



**VFD-M-D**

***User Manual***

Specific AC Motor Drives for the Elevator Door

## Preface

---

Thank you for choosing DELTA's high-performance VFD-M-D Series. The VFD-M-D Series is manufactured with high-quality components and materials and incorporate the latest microprocessor technology available.

This manual is to be used for the installation, parameter setting, troubleshooting, and daily maintenance of the AC motor drive. To guarantee safe operation of the equipment, read the following safety guidelines before connecting power to the AC motor drive. Keep this operating manual at hand and distribute to all users for reference.

To ensure the safety of operators and equipment, only qualified personnel familiar with AC motor drive are to do installation, start-up and maintenance. Always read this manual thoroughly before using VFD-M-D series AC Motor Drive, especially the WARNING, DANGER and CAUTION notes. Failure to comply may result in personal injury and equipment damage. If you have any questions, please contact your dealer.

### **PLEASE READ PRIOR TO INSTALLATION FOR SAFETY.**



- 
1. Ensure that VFD-M-D is grounded in a correct way before putting it into use.
  2. AC input power must be disconnected before any wiring to the AC motor drive is made.
  3. A charge may still remain in the DC-link capacitors with hazardous voltages, even if the power has been turned off. To prevent personal injury, please ensure that power has been turned off before opening the AC motor drive and wait ten minutes for the capacitors to discharge to safe voltage levels.
  4. Never reassemble internal components or wiring.
  5. The AC motor drive may be destroyed beyond repair if incorrect cables are connected to the input/output terminals. Never connect the AC motor drive output terminals U/T1, V/T2, and W/T3 directly to the AC mains circuit power supply.
  6. Ground the VFD-M-D using the ground terminal. The grounding method must comply with the laws of the country where the AC motor drive is to be installed. Refer to the Basic Wiring Diagram.
  7. VFD-M-D series is used only to control variable speed of 3-phase induction motors, NOT for 1-phase motors or other purpose.

8. VFD-M-D series is the specific drive for the elevator door and other automatic door control, NOT for those devices that may cause personal injury, such as life support equipment or any life safety situation.
9. VFD-M-D is produced with strict quality management. It will need the safety device when it is used in those occasions that may cause severe accident due to the malfunction.

**WARNING!**

---

1. DO NOT use Hi-pot test for internal components. The semi-conductor used in the AC motor drive is easily damaged by high-pressure.
2. There are highly sensitive MOS components on the printed circuit boards. These components are especially sensitive to static electricity. To prevent damage to these components, do not touch these components or the circuit boards with metal objects or your bare hands.
3. Only quality person is allowed to install, wire and maintain AC motor drive.

**CAUTION!**

---

1. Some parameter settings will cause the motor to run immediately after applying power.
2. DO NOT install the AC motor drive in a place subjected to high temperature, direct sunlight, high humidity, excessive vibration, corrosive gases or liquids, or airborne dust or metallic particles.
3. Only use AC motor drives within specification. Failure to comply may result in fire, explosion or electric shock.
4. To prevent personal injury, please keep children and unqualified people away from the equipment.
5. When the motor cable between the AC motor drive and motor is too long, the layer insulation of the motor may be damaged. Please use a frequency inverter duty motor or add an AC output reactor to prevent damage to the motor. Refer to appendix B Reactor for details.
6. The rated voltage for the AC motor drive must be  $\leq 240V$  and the mains supply current capacity must be  $\leq 5000A$  RMS.

# Table of Contents

---

<b>Preface</b> .....	<b>i</b>
<b>Table of Contents</b> .....	<b>iii</b>
<b>Chapter 1 Introduction</b> .....	<b>1-1</b>
1.1 Receiving and Inspection .....	1-2
1.1.1 Nameplate Information .....	1-2
1.1.2 Model Explanation .....	1-2
1.1.3 Series Number Explanation .....	1-3
1.1.4 Appearances .....	1-3
1.1.5 Remove Instructions .....	1-4
1.2 Preparation for Installation and Wiring .....	1-5
1.2.1 Ambient Conditions .....	1-5
1.2.2 Minimum Mounting Clearance .....	1-6
1.3 Dimensions .....	1-8
<b>Chapter 2 Wiring</b> .....	<b>2-1</b>
2.1 Basic Wiring Diagrams .....	2-2
2.2 External Wiring .....	2-6
2.3 Main Circuit .....	2-7
2.3.1 Main Terminals Connections .....	2-7
2.3.2 Main Circuit Terminals .....	2-9
2.4 Control Circuit .....	2-10

2.4.1 Circuit diagram for digital inputs (NPN mode) .....	2-10
2.4.2 Control Terminals .....	2-13
<b>Chapter 3 Keypad and Start Up .....</b>	<b>3-1</b>
3.1 Keypad .....	3-1
3.1.1 Description of the Digital Keypad LC-M2E .....	3-1
3.1.2 How to Operate the Digital Keypad LC-M2E .....	3-2
3.1.3 LC-M2E .....	3-3
3.2 Preparations before Start-up.....	3-4
3.3 Operation Method .....	3-5
3.4 Trial Run .....	3-5
<b>Chapter 4 Parameters .....</b>	<b>4-1</b>
4.1 Summary of Parameter Settings .....	4-2
4.2 Description of Parameter Settings .....	4-14
4.3 The Flow Chart for Parameter Settings .....	4-89
<b>Chapter 5 Troubleshooting .....</b>	<b>5-1</b>
5.1 Over Current (OC) .....	5-1
5.2 Ground Fault.....	5-2
5.3 Over Voltage (OV) .....	5-2
5.4 Low Voltage (Lv).....	5-3
5.5 Over Heat (OH).....	5-4
5.6 Overload .....	5-4
5.7 Display of LC-M2E is Abnormal .....	5-5
5.8 Phase Loss (PHL).....	5-5
5.9 Motor cannot Run .....	5-6
5.10 Motor Speed cannot be Changed .....	5-7

5.11 Motor Stalls during Acceleration .....	5-8
5.12 The Motor does not Run as Expected .....	5-8
5.13 Electromagnetic/Induction Noise .....	5-9
5.14 Environmental Condition .....	5-9
5.15 Affecting Other Machines .....	5-10
<b>Chapter 6 Fault Code Information and Maintenance.....</b>	<b>6-1</b>
6.1 Fault Code Information .....	6-1
6.1.1 Common Problems and Solutions.....	6-1
6.1.2 Reset .....	6-4
6.2 Maintenance and Inspections.....	6-5
<b>Appendix A Specifications .....</b>	<b>A-1</b>
<b>Appendix B Accessories .....</b>	<b>B-1</b>
B.1 All Brake Resistors & Brake Units Used in AC Motor Drives.....	B-1
B.1.1 Dimensions and Weights for Brake Resistors .....	B-2
B.2 Non-fuse Circuit Breaker Chart .....	B-3
B.3 Fuse Specification Chart.....	B-3
B.4 Reactor .....	B-4
B.4.1 AC Reactor .....	B-4
B.4.2 Zero Phase Reactor (RF220X00A).....	B-6
B.5 VFD-PU06.....	B-7
B.5.1 Description of the Digital keypad VFD-PU06.....	B-7
B.5.2 Explanation of Display Message.....	B-7
B.5.3 VFD-PU06 Operation Flow Chart .....	B-8
B.6 AMD - EMI Filter Cross Reference.....	B-9
B.6.1 Dimensions.....	B-12



<b>Appendix C How to Select the Right AC Motor Drive .....</b>	<b>C-1</b>
C.1 Capacity Formulas .....	C-2
C.2 General Precaution .....	C-4
C.3 How to Choose a Suitable Motor.....	C-5

## Chapter 1 Introduction

---

The AC motor drive should be kept in the shipping carton or crate before installation. In order to retain the warranty coverage, the AC motor drive should be stored properly when it is not to be used for an extended period of time. Storage conditions are:

Store in a clean and dry location free from direct sunlight or corrosive fumes.

Store within an ambient temperature range of  $-20^{\circ}\text{C}$  to  $+60^{\circ}\text{C}$ .

Store within a relative humidity range of 0% to 90% and non-condensing environment.

Store within an air pressure range of 86kPA to 106kPA.



### **CAUTION!**

1. DO NOT store in an area with rapid changes in temperature. It may cause condensation and frost.
2. DO NOT place on the ground directly. It should be stored properly. Moreover, if the surrounding environment is humid, you should put exsiccator in the package.
3. If the AC motor drive is stored for more than 3 months, the temperature should not be higher than  $30^{\circ}\text{C}$ . Storage longer than one year is not recommended, it could result in the degradation of the electrolytic capacitors.
4. When the AC motor drive is not used for a long time after installation on building sites or places with humidity and dust, it's best to move the AC motor drive to an environment as stated above.

## 1.1 Receiving and Inspection

This VFD-M-D AC motor drive has gone through rigorous quality control tests at the factory before shipment. After receiving the AC motor drive, please check for the following:

- Check to make sure that the package includes an AC motor drive, the User Manual/Quick Start and CD, dust covers and rubber bushings.
- Inspect the unit to assure it was not damaged during shipment.
- Make sure that the part number indicated on the nameplate corresponds with the part number of your order.

### 1.1.1 Nameplate Information

Example for 0.5HP/0.4kW 230V 1-Phase 230V AC motor drive

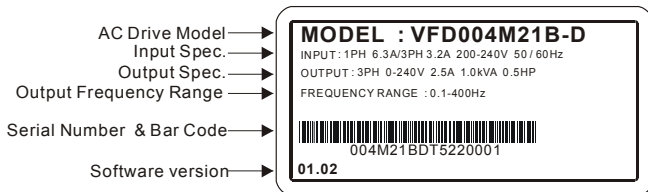

### 1.1.2 Model Explanation

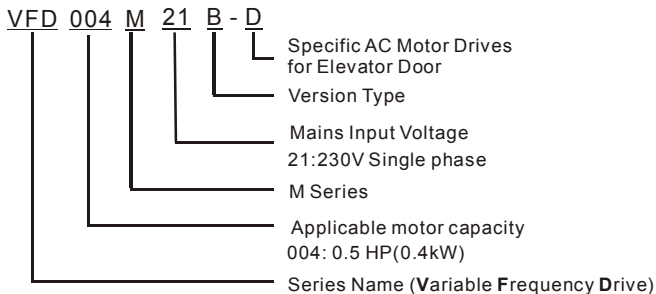

### 1.1.3 Series Number Explanation

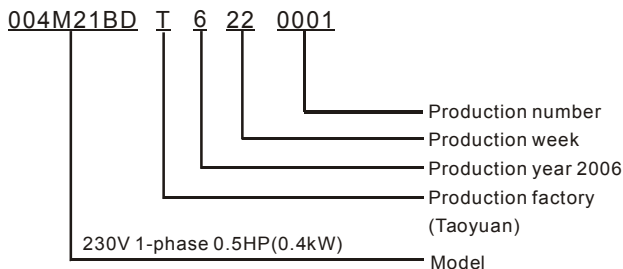

If the nameplate information does not correspond to your purchase order or if there are any problems, please contact your distributor.

### 1.1.4 Appearances

VFD004M21B-D



VFD004M21W-D



---

### 1.1.5 Remove Instructions

#### Remove Keypad

---



## Remove Front Cover

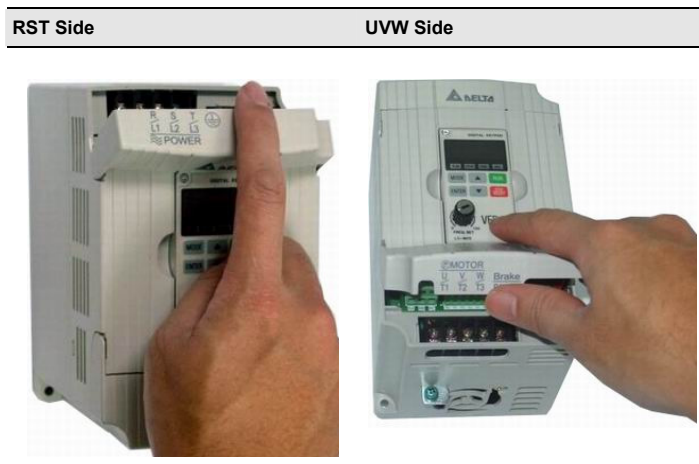

## 1.2 Preparation for Installation and Wiring

### 1.2.1 Ambient Conditions

Install the AC motor drive in an environment with the following conditions:

Operation	Air Temperature:	-10 ~ +50°C (14 ~ 122°F) for UL & cUL
	Relative Humidity:	<90%, no condensation allowed
	Atmosphere pressure:	86 ~ 106 kPa
	Installation Site Altitude:	<1000m
	Vibration:	<20Hz: 9.80 m/s <sup>2</sup> (1G) max 20 ~ 50Hz: 5.88 m/s <sup>2</sup> (0.6G) max

Storage Transportation	Temperature:	-20°C ~ +60°C (-4°F ~ 140°F)
	Relative Humidity:	<90%, no condensation allowed
	Atmosphere pressure:	86 ~ 106 kPa
	Vibration:	<20Hz: 9.80 m/s <sup>2</sup> (1G) max 20 ~ 50Hz: 5.88 m/s <sup>2</sup> (0.6G) max

Pollution Degree 2: good for a factory type environment.



**CAUTION!**

1. Operating, storing or transporting the AC motor drive outside these conditions may cause damage to the AC motor drive.
2. Failure to observe these precautions may void the warranty!

## 1.2.2 Minimum Mounting Clearance

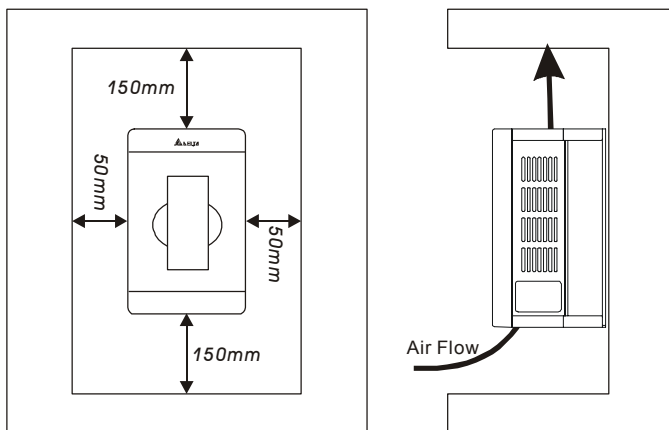

### CAUTION!

1. Mount the AC motor drive vertically on a flat vertical surface by using bolts or screws. Other directions are not allowed.
2. The AC motor drive will generate heat during operation. Allow sufficient space around the unit for heat dissipation.
3. The heat sink temperature may rise to 90°C when running. The material on which the AC motor drive is mounted must be noncombustible and be able to withstand this high temperature.
4. When the AC motor drive is installed in a confined space (e.g. cabinet), the surrounding temperature must be within 10 ~ 40°C with good ventilation. DO NOT install the AC motor drive in a space with bad ventilation.
5. Prevent fiber particles, scraps of paper, saw dust, metal particles, etc. from adhering to the heatsink.
6. When installing multiple AC motor drives in the same cabinet, they should be adjacent in a row with enough space in-between. When installing one AC motor drive below another one, use a metal separation barrier between the AC motor drives to prevent mutual heating.

## Installation with Metal Separation

## Installation without Metal Separation

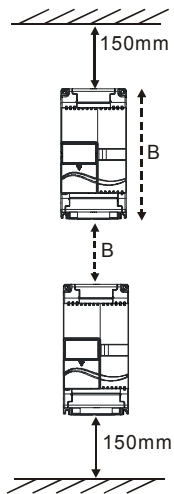
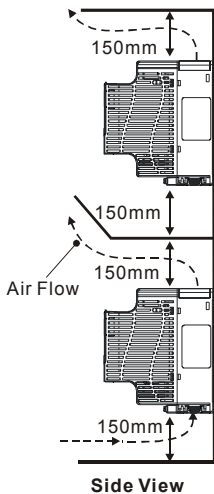



## 1.3 Dimensions

(Dimensions are in millimeter and [inch])

VFD004M21B-D

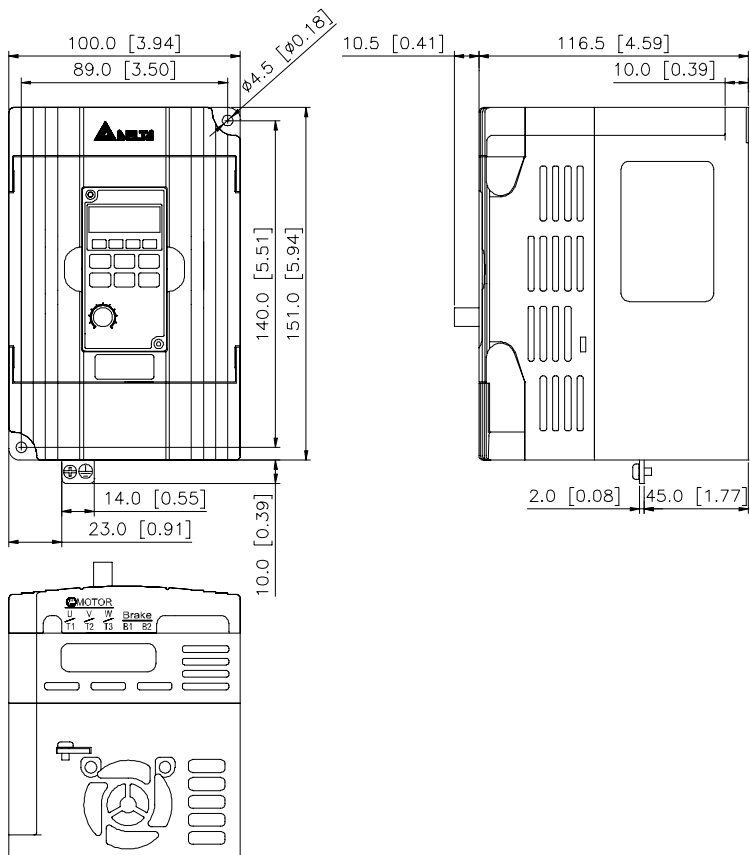

VFD004M21W-D

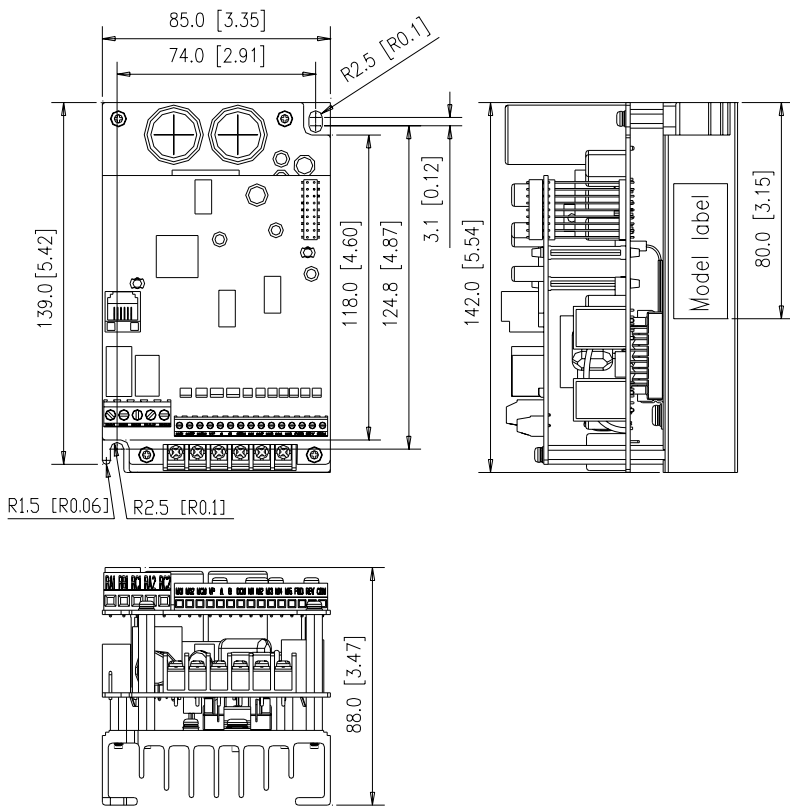

This page intentionally left blank.

## Chapter 2 Wiring

---

After removing the front cover, check if the power and control terminals are clear of debris. Be sure to observe the following precautions when wiring.

### ■ General Wiring Information

#### Applicable Codes

All VFD-M-D series except VFD004M21W-D are Underwriters Laboratories, Inc. (UL) and Canadian Underwriters Laboratories (cUL) listed, and therefore comply with the requirements of the National Electrical Code (NEC) and the Canadian Electrical Code (CEC).

Installation intended to meet the UL and cUL requirements must follow the instructions provided in "Wiring Notes" as a minimum standard. Follow all local codes that exceed UL and cUL requirements. Refer to the technical data label affixed to the AC motor drive and the motor nameplate for electrical data.

The "Line Fuse Specification" in Appendix B, lists the recommended fuse part number for each VFD-M-D series part number. These fuses (or equivalent) must be used on all installations where compliance with U.L. standards is a required.



VFD004M21W-D has no approvals.



- 
- Make sure that power is only applied to the R/L1, S/L2, T/L3 terminals. Failure to comply may result in damage to the equipment. The voltage and current should lie within the range as indicated on the nameplate.
  - Check the following items after completing the wiring:
    1. Are all connections correct?
    2. No loose wires?
    3. No short-circuits between terminals or to ground?

A charge may still remain in the DC bus capacitors with hazardous voltages even if the power has been turned off. To prevent personal injury, please ensure that the power is turned off and wait ten minutes for the capacitors to discharge to safe voltage levels before opening the AC motor drive.



**DANGER!**

---

1. All the units must be grounded directly to a common ground terminal to prevent electric shock, fire and interference.
2. Only qualified personnel familiar with AC motor drives are allowed to perform installation, wiring and commissioning.
3. Make sure that the power is off before doing any wiring to prevent electric shocks.

## 2.1 Basic Wiring Diagrams

Users must connect wires according to the circuit diagrams on the following pages. Do not plug a modem or telephone line to the RS-485 communication port or permanent damage may result.

Terminals 1 & 2 are the power supply for the optional copy keypad PU06 only and should not be used for RS-485 communication.

The figure below for models of VFD-M-D series

VFD004M21B-D; VFD004M21W-D

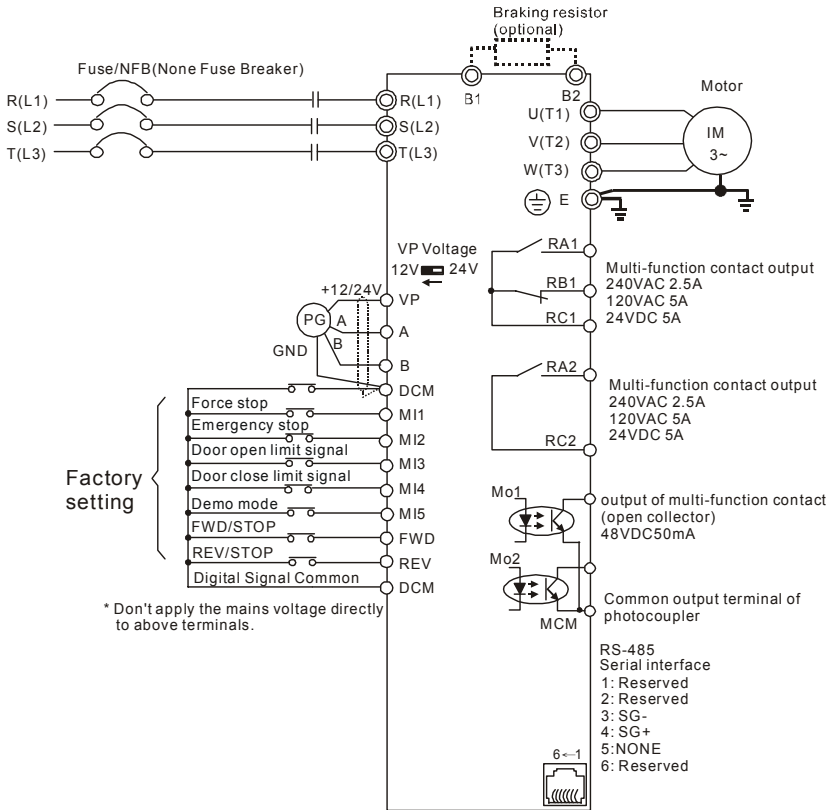

1. The wiring of main circuit and control circuit should be separated to prevent erroneous actions.
2. Please use shield wire for the control wiring and not to expose the peeled-off net in front of the terminal.
3. Please use the shield wire or tube for the power wiring and ground the two ends of the shield wire or tube.

## Chapter 2 Wiring | VFD-M-D Series

4. Damaged insulation of wiring may cause personal injury or damage to circuits/equipment if it comes in contact with high voltage.
5. The AC motor drive, motor and wiring may cause interference. To prevent the equipment damage, please take care of the erroneous actions of the surrounding sensors and the equipment.
6. When the AC drive output terminals U/T1, V/T2, and W/T3 are connected to the motor terminals U/T1, V/T2, and W/T3, respectively. To permanently reverse the direction of motor rotation, switch over any of the two motor leads.
7. With long motor cables, high capacitive switching current peaks can cause over-current, high leakage current or lower current readout accuracy. To prevent this, the motor cable should be less than 20m for 3.7kW models and below. And the cable should be less than 50m for 5.5kW models and above. For longer motor cables use an AC output reactor.
8. The AC motor drive, electric welding machine and the greater horsepower motor should be grounded separately.
9. Use ground leads that comply with local regulations and keep them as short as possible.
10. No brake resistor is built in the VFD-M-D series, it can install brake resistor for those occasions that use higher load inertia or frequent start/stop. Refer to Appendix B for details.
11. Multiple VFD-M-D units can be installed in one location. All the units should be grounded directly to a common ground terminal, as shown in the figure below. **Ensure there are no ground loops.**

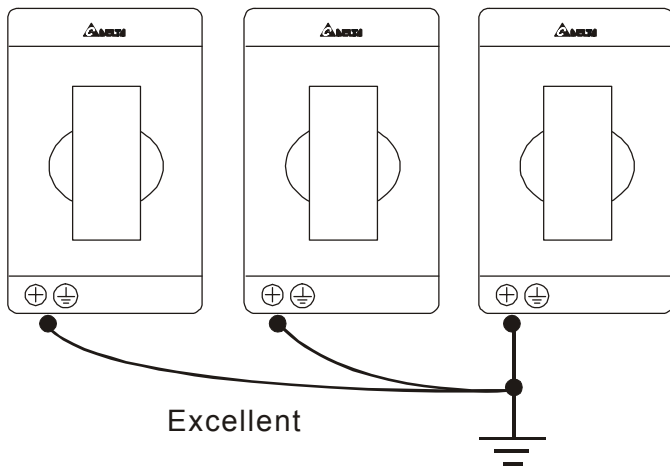

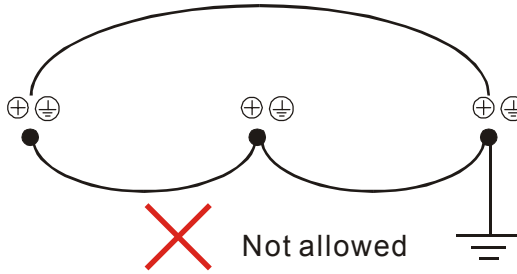
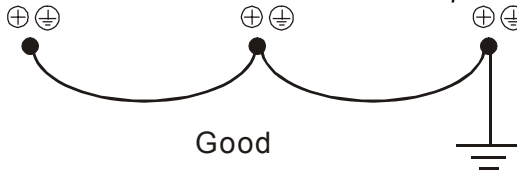



## 2.2 External Wiring

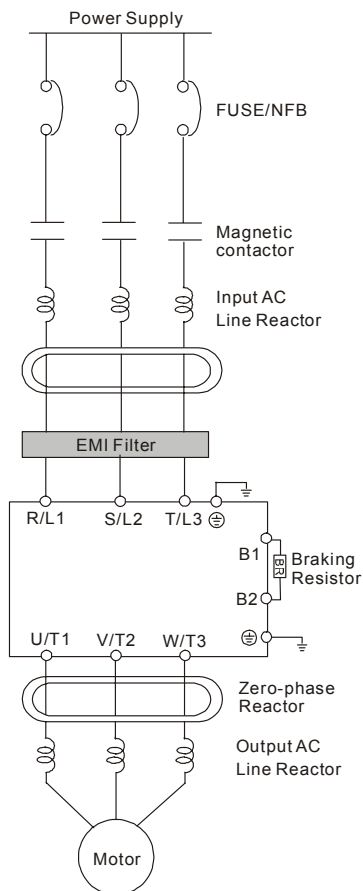

Items	Explanations
Power supply	Please follow the specific power supply requirements shown in Appendix A.
Fuse/NFB (Optional)	There may be an inrush current during power up. Please check the chart of Appendix B and select the correct fuse with rated current. Use of an NFB is optional.
Magnetic contactor (Optional)	Please do not use a Magnetic contactor as the I/O switch of the AC motor drive, as it will reduce the operating life cycle of the AC drive.
Input AC Line Reactor (Optional)	Used to improve the input power factor, to reduce harmonics and provide protection from AC line disturbances- (surges, switching spikes, short interruptions, etc.). AC line reactor should be installed when the power supply capacity is 500kVA or more and exceeds 6 times the inverter capacity, or the mains wiring distance $\leq 10m$ .
Zero-phase Reactor (Ferrite Core Common Choke) (Optional)	Zero phase reactors are used to reduce radio noise especially when audio equipment is installed near the inverter. Effective for noise reduction on both the input and output sides. Attenuation quality is good for a wide range from AM band to 10MHz. Appendix B specifies the zero phase reactor. (RF220X00A)
EMI filter (Optional)	To reduce electromagnetic interference, please refer to Appendix B for more details.
Brake Resistor (Optional)	Used to reduce the deceleration time of the motor. Please refer to the chart in Appendix B for specific Brake Resistors.
Output AC Line Reactor (Optional)	Motor surge voltage amplitude depends on motor cable length. For applications with long motor cable (>20m), it is necessary to install a reactor at the inverter output side.

## 2.3 Main Circuit

### 2.3.1 Main Terminals Connections

The figure below for models of VFD-M-D series

VFD004M21B-D; VFD004M21W-D

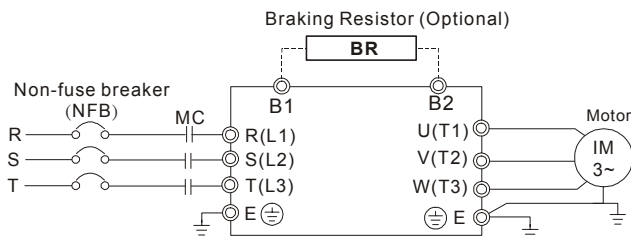

Terminal Symbol	Explanation of Terminal Function
R/L1, S/L2, T/L3	AC line input terminals (1-phase/3-phase)
U/T1, V/T2, W/T3	AC drive output terminals for connecting 3-phase induction motor
B1, B2	Connections for Brake Resistor (optional)
⊕	Earth connection, please comply with local regulations.



#### CAUTION!

#### Mains power terminals (R/L1, S/L2, T/L3)

- Connect these terminals (R/L1, S/L2, T/L3) via a non-fuse breaker or earth leakage breaker to 3-phase AC power (some models to 1-phase AC power) for circuit protection. It is unnecessary to consider phase-sequence.
- It is recommended to add a magnetic contactor (MC) in the power input wiring to cut off power quickly and reduce malfunction when activating the protection function of AC motor drives. Both ends of the MC should have an R-C surge absorber.
- Please make sure to fasten the screw of the main circuit terminals to prevent sparks which is made by the loose screws due to vibration.
- Please use voltage and current within the regulation shown in Appendix A.

## Chapter 2 Wiring | VFD-M-D Series

- When using a GFCI (Ground Fault Circuit Interrupter), select a current sensor with sensitivity of 200mA, and not less than 0.1-second detection time to avoid nuisance tripping.

### Output terminals for main circuit (U, V, W)

- When it needs to install the filter at the output side of terminals U/T1, V/T2, W/T3 on the AC motor drive. Please use inductance filter. Do not use phase-compensation capacitors or L-C (Inductance-Capacitance) or R-C (Resistance-Capacitance), unless approved by Delta.
- DO NOT connect phase-compensation capacitors or surge absorbers at the output terminals of AC motor drives.
- Use a well-insulated motor, suitable for inverter operation.
- When using a GFCI (Ground Fault Circuit Interrupter), select a current sensor with sensitivity of 200mA, and not less than 0.1-second detection time to avoid nuisance tripping.

### Terminals [B1, B2] for connecting external brake unit

Braking resistor(optional)  
Refer to Appendix B for the use of  
special braking resistor



- Connect a brake resistor or brake unit in applications with frequent deceleration ramps, short deceleration time, too low brake torque or requiring increased brake torque.
- The AC motor drive has a built-in brake chopper, you can connect the external brake resistor to the terminals [B1, B2] when needed.
- When not used, please leave the terminals [B1, B2] open.

## 2.3.2 Main Circuit Terminals

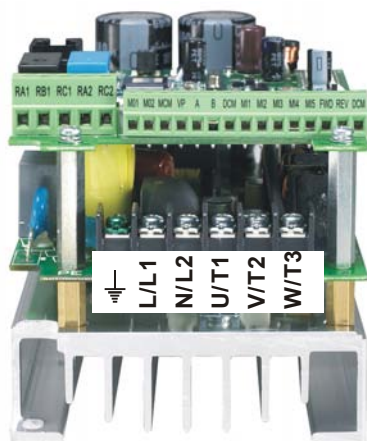
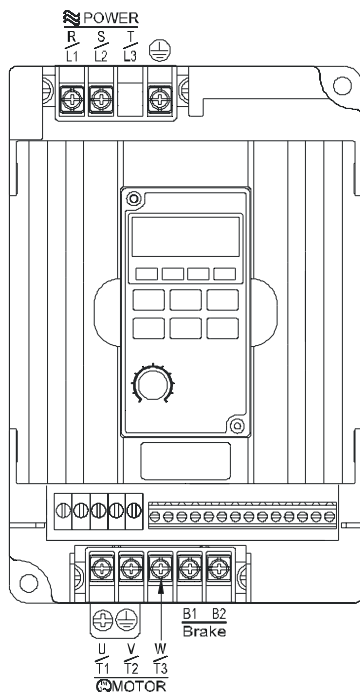

Frame	Power Terminals	Torque	Wire Gauge	Wire Type
A	R/L1, S/L2, T/L3 (M-D) L/L1, N/L2 (W-D)	14kgf-cm (12in-lbf)	12-14 AWG. (3.3-2.1mm <sup>2</sup> )	Copper only, 75°C
	U/T1, V/T2, W/T3,			

**NOTE**

Frame A: VFD004M21B-D; VFD004M21W-D

## 2.4 Control Circuit

### 2.4.1 Circuit diagram for digital inputs (NPN mode)

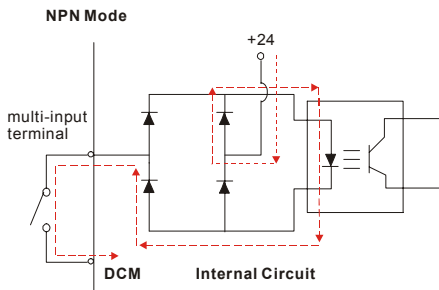

#### Terminal symbols and functions

Terminal Symbol	Terminal Function	Factory Settings ON: Connect to DCM
FWD	Forward-Stop command	ON: Run in FWD direction (door close) OFF: Stop acc. to Stop Method
REV	Reverse-Stop command	ON: Run in REV direction (door open) OFF: Stop acc. to Stop Method
MI1	Multi-function Input 1	Refer to Pr.5-00 to Pr.5-04 for programming the Multi-function Inputs. ON: the activation current is 16mA. OFF: leakage current tolerance is 10 $\mu$ A.
MI2	Multi-function Input 2	
MI3	Multi-function Input 3	
MI4	Multi-function Input 4	
MI5	Multi-function Input 5	
DCM	Digital Signal Common	Common for digital inputs.
A	A-phase Input Terminal	This terminal is used for feedback pulse input. It also can be used as multi-function input terminal.
B	B-phase Input Terminal	Maximum pulse: 500KP/Sec Support types: voltage output and open collector.
VP	+12/24 Vdc Output	It can apply +12 or +24 VDC power for encoder and change by switch (12V/100mA, 24V/50mA).

Terminal Symbol	Terminal Function	Factory Settings ON: Connect to DCM
RA1	Multi-function Relay1 output (N.O.) a	Resistive Load: 5A(N.O.)/3A(N.C.) 240VAC 5A(N.O.)/3A(N.C.) 24VDC  Inductive Load: 1.5A(N.O.)/0.5A(N.C.) 240VAC 1.5A(N.O.)/0.5A(N.C.) 24VDC Refer to Pr.6-00 and Pr.6-01 for programming
RB1	Multi-function Relay1 output (N.C.) b	
RC1	Multi-function Relay1 common	
RA2	Multi-function Relay2 output (N.O.) a	
RC2	Multi-function Relay2 common	
MO1	Multi-function Output 1 (Photocoupler)	Maximum 48VDC, 50mA Refer to Pr.6-02 to Pr.6-03 for programming
MO2	Multi-function Output 2 (Photocoupler)	<p>MO1~MO2-DCM</p> <p>Max: 48Vdc 50mA</p> <p>MO1-MO2</p> <p>MCM</p> <p>Internal Circuit</p>
MCM	Multi-function output common	Common for Multi-function Outputs

\* Control signal wiring size: 18 AWG (0.75 mm<sup>2</sup>) with shielded wire.

**Digital inputs (MI1~MI5, DCM)**

- When using contacts or switches to control the digital inputs, please use high quality components to avoid contact bounce.

**Digital outputs (MO1, MO2, MCM)**

- Make sure to connect the digital outputs to the right polarity, see wiring diagrams.
- When connecting a relay to the digital outputs, connect a surge absorber or fly-back diode across the coil and check the polarity.

**General**

- Keep control wiring as far away as possible from the power wiring and in separate conduits to avoid interference. If necessary let them cross only at 90° angle.
- The AC motor drive control wiring should be properly installed and not touch any live power wiring or terminals.
- Never to connect or disconnect any wiring when there are messages displayed on the digital keypad.

## 2.4.2 Control Terminals

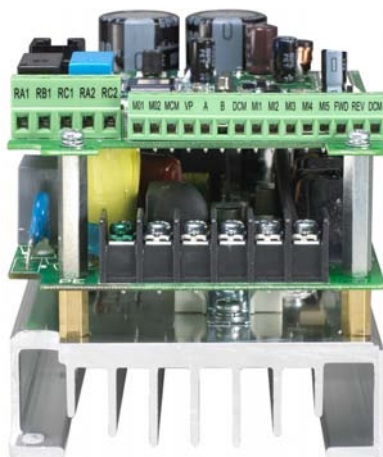
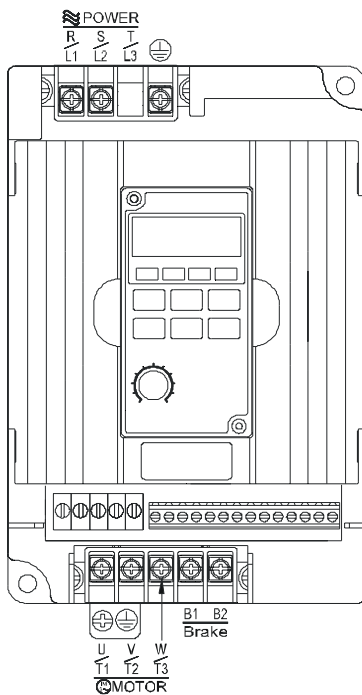

Frame	Control Terminals	Torque	Wire Gauge
A	Terminals	2.5kgf-cm (2.2in-lbf)	16-22 AWG.



Frame A: VFD004M21B-D; VFD004M21W-D



This page intentionally left blank.

## Chapter 3 Keypad and Start Up



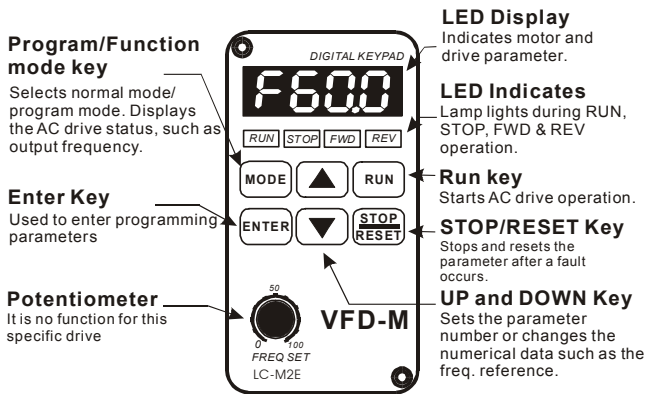

### 3.1 Keypad

#### 3.1.1 Description of the Digital Keypad LC-M2E

Among VFD-M-D series, messages are displayed by the digital keypad for VFD004M21B-D, whereas there is no digital keypad for VFD004M21W-D, use of PU06 is optional.



Display Message	Descriptions
<b>F600</b>	Displays the AC drive Master Frequency.
<b>H500</b>	Displays the actual output frequency present at terminals U/T1, V/T2, and W/T3.
<b>U180</b>	User defined unit (where U = F x Pr.0-05)
<b>A 50</b>	Displays the output current present at terminals U/T1, V/T2, and W/T3.
<b>Frd</b>	Displays the AC motor drive forward run status.
<b>rEv</b>	Displays the AC motor drive reverse run status.

Display Message	Descriptions
	Displays the selected parameter.
	Displays the actual stored value of the selected parameter.
	External Fault.
	Display "End" for approximately 1 second if input has been accepted.
	Display "Err", if the input is invalid.

### 3.1.2 How to Operate the Digital Keypad LC-M2E

#### Selection mode



NOTE: In the selection mode, press  to set the parameters.

#### To set parameters

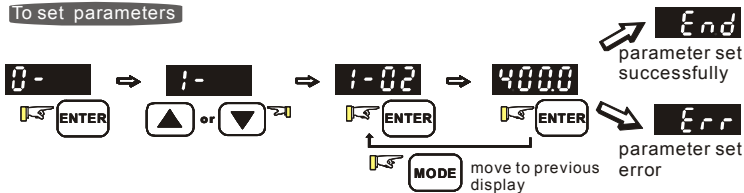

NOTE: In the parameter setting mode, you can press  to return to the selection mode.

#### To modify data



#### To set direction



## 3.1.3 LC-M2E

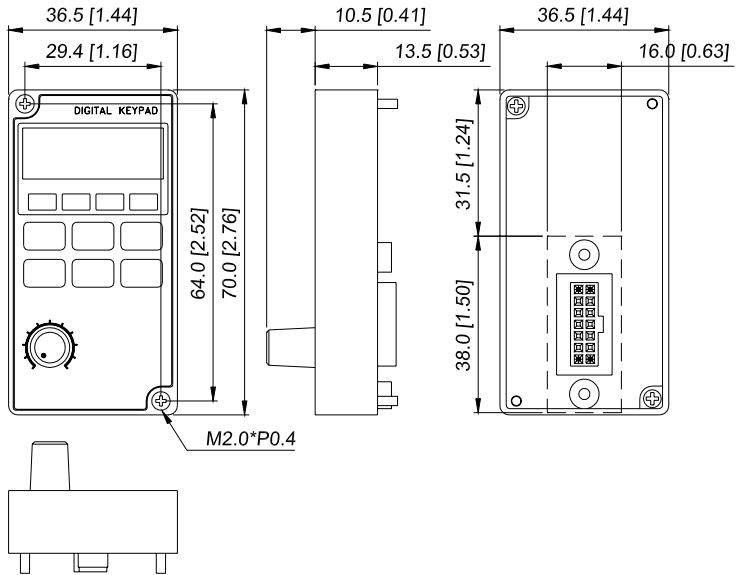

Unit: mm [inch]

Reference Table for the 7-segment LED Display of the Digital Keypad

Digit	0	1	2	3	4	5	6	7	8	9
LED Display	0	1	2	3	4	5	6	7	8	9

English alphabet	A	b	Cc	d	E	F	G	Hh	I	Jj
LED Display	A	b	Cc	d	E	F	G	Hh	I	Jj

English alphabet	K	L	n	Oo	P	q	r	S	Tt	U
LED Display	K	L	n	Oo	P	q	r	S	Tt	U

English alphabet	v	Y	Z							
LED Display	v	Y	Z							

## 3.2 Preparations before Start-up

Carefully check the following items before proceeding.

- Make sure that the wiring is correct. In particular, check that the output terminals U, V, W, are NOT connected to power and that the drive is well grounded.
- Verify that there are no short-circuits between terminals and from terminals to ground or mains power.
- Check for loose terminals, connectors or screws.
- Verify that no other equipment is connected to the AC motor
- Make sure that all switches are OFF before applying power to ensure that the AC motor drive doesn't start running and there is no abnormal operation after applying power.
- Make sure that the front cover is correctly installed before applying power.
- Do NOT operate the AC motor drive with humid hands.

Check the following items after applying power:

- The keypad should light up as follows (normal status with no error)





When power is ON, LEDs "STOP" and "FWD" should light up. The display will show "F4.00" .

- The built-in fan should run (the factory setting of fan control Pr.0-16=03)



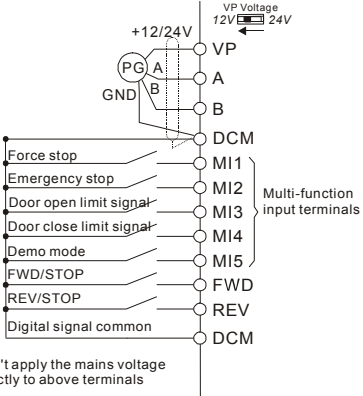

### 3.3 Operation Method

The operation method can be set via control terminals and LC-M2E keypad. Please choose a suitable method depending on application and operation rule.

Operation Method	Frequency Source	Operation Command Source
LC-M2E keypad		
Operate from external signal	 <p>Parameter setting: Pr. 5-00~Pr.5-04 to 01~04</p>	External terminals input: FWD-DCM REV-DCM

### 3.4 Trial Run

After finishing checking the items in “3.2 preparation before start-up”, you can perform a trial run. The factory setting of the operation source is from the keypad (Pr.0-12=00).

1. After applying power, verify that the display shows F4.00Hz.
2. Pressing  key for forward running (door close). And if you want to change to reverse running (door open), you should press  or  key. And if you want to decelerate to stop, please press  key.

3. Check following items:
  - Check if the motor direction of rotation is correct.
  - Check if the motor runs steadily without abnormal noise and vibration.
  - Check if acceleration and deceleration are smooth.

If the results of trial run are normal, please start the formal run.



1. Stop running immediately if any fault occurs and refer to the troubleshooting guide for solving the problem.
2. Do NOT touch output terminals U, V, W when power is still applied to L1/R, L2/S, L3/T even when the AC motor drive has stopped. The DC-link capacitors may still be charged to hazardous voltage levels, even if the power has been turned off.
3. To avoid damage to components, do not touch them or the circuit boards with metal objects or your bare hands.

## Chapter 4 Parameters

---

The VFD-M-D parameters are divided into 9 groups by property for easy setting. In most applications, the user can finish all parameter settings before start-up without the need for re-adjustment during operation.

The 9 groups are as follows:

Group 0 User Parameters

Group 1 Basic Parameters

Group 2 Motor and Feedback Function Parameters

Group 3 Door Open Parameters

Group 4 Door Close Parameters

Group 5 Multi-Step Speed and PLC Parameters

Group 6 Digital Output Parameters

Group 7 Protection and Special Parameters

Group 8 Communication Parameters



## 4.1 Summary of Parameter Settings

↗: The parameter can be set during operation.

### Group 0 User Parameters

Parameter	Explanation	Settings	Factory Setting	Customer
0-00	Identity Code of the AC motor drive	Read-only	##	
0-01	Rated Current Display of the AC motor drive	Read-only	#.#	
0-02	Parameter Reset	08: Keypad lock 09: All parameters are reset to factory settings (50Hz, 230V) 10: All parameters are reset to factory settings (60Hz, 220V)	00	
↗0-03	Start-up Display Selection	00: Display the frequency command value (F) 01: Display the actual output frequency (H) 02: Display the content of user-defined unit (U) 03: Multifunction display, see Pr.0-04 04: FWD/REV command	00	
↗0-04	Content of Multi Function Display	00: Display output current (A) 01: Display the pulses 02: Display the walking distance and step speed (1.tt) 03: Display DC-BUS voltage ( $\bar{u}$ ) 04: Display output voltage (E) 05: Output power factor angle (n) 06: Display output power (P) 07: Display actual motor speed 08: Display the estimated value of torque as it relates to current (t) 09: Display PG numbers/10ms (G) 10: Display the temperature of heat sink ( $^{\circ}$ C) 11: Display external input terminal status (l.) 12: Display external output terminal status (o.) 13: Display communication address (d.)	00	
↗0-05	User-Defined Coefficient K	0.01 to 160.0	1.00	
0-06	Software Version	Read-only	#.##	
↗0-07	Password Input	00 to 9999	00	
↗0-08	Password Set	00 to 9999	00	
0-09	Door Control Mode	00: Distance control mode 1 01: Distance control mode 2 02: Multi-step control mode 1 03: Multi-step control mode 2 04: Multi-step control mode 3 05: Multi-step control mode 4	00	

Parameter	Explanation	Settings	Factory Setting	Customer
0-10	PWM Carrier Frequency Selections	01~15 kHz	12	
0-11	AVR Function	00: AVR function enable 01: AVR function disable 02: AVR function disable for decel.	00	
↗0-12	Source of Operation Command	00: Digital keypad 01: External terminals. Keypad STOP enabled. 02: External terminals. Keypad STOP disabled. 03: RS-485 serial communication (RJ-11). Keypad STOP enabled. 04: RS-485 serial communication (RJ-11). Keypad STOP disabled.	00	
0-13	Stop Method	00: Ramp to stop 01: Coast to stop	00	
0-14	Door Open/Close Control	00: Enable door open/close operation 01: Disable door open operation 02: Disable door close operation	00	
0-15	Position Mode	00: No limit signal, detected by PG number or current level 01: Door open limit signal only, door close limit is detected by PG number or current level 02: Door close limit signal only, door open limit is detected by PG number or current level 03: Door open and close limit signal 04: Detect by PG number and also accept external door open/close limit signal	00	
0-16	Fan Control	00: Always fan on 01: Drive stops 1 minute later, fan stop running 02: Run and fan on, stop and fan off 03: Preliminary temperature attained, fan start to run (when temperature is equal or higher than 60 °C, it runs. When it is less than 40 °C, it stops.	03	
↗0-17	Stall Current Level of Position Mode	0.0~200.0%	30.0	
0-18	Control Methods	00: V/F control 01: Vector Control	00	

### Group 1 Basic Parameters

Parameter	Explanation	Settings	Factory Setting	Customer
1-00	Maximum Output Frequency (Fmax)	50.00 to 400.0 Hz	60.00	
1-01	Maximum Voltage Frequency (Fbase)	0.10 to 400.0 Hz	60.00	
1-02	Maximum Output Voltage (Vmax)	230V series: 0.1V to 255.0V	220.0	

Parameter	Explanation	Settings	Factory Setting	Customer
1-03	Mid-Point Frequency (Fmid)	0.10 to 400.0 Hz	0.50	
1-04	Mid-Point Voltage (Vmid)	230V series: 0.1V to 255.0V	1.7	
1-05	Minimum Output Frequency (Fmin)	0.10 to 400.0 Hz	0.50	
1-06	Minimum Output Voltage (Vmin)	230V series: 0.1V to 255.0V	1.7	
↗1-07	Frequency Setting for Low Speed Operation	0.10 Hz to 400.0 Hz	4.00	
↗1-08	Acceleration Time for Low Speed Operation	0.1 to 3600 sec	2.0	
↗1-09	Deceleration Time for Low Speed Operation	0.1 to 3600 sec	2.0	
1-10	Skip Frequency 1 Upper Limit	0.00 to 400.0 Hz	0.00	
1-11	Skip Frequency 1 Lower Limit	0.00 to 400.0 Hz	0.00	
1-12	Skip Frequency 2 Upper Limit	0.00 to 400.0 Hz	0.00	
1-13	Skip Frequency 2 Lower Limit	0.00 to 400.0 Hz	0.00	

## Group 2 Motor and Feedback Function Parameters

Parameter	Explanation	Settings	Factory Setting	Customer
2-00	Motor Parameters Auto Tuning	00: Disable 01: Auto tuning R1 02: Auto tuning R1 + no-load test	00	
↗2-01	Motor Rated Current	FLA*5% ~ FLA*120% (FLA=2.5A)	2.50	
↗2-02	Motor No-Load Current	FLA*0% ~ motor rated current	1.00	
↗2-03	Torque Compensation	0.0 to 10.0	1.0	
2-04	Number of Motor Poles	02~16	04	
2-05	Motor Line-to-line Resistance R1	0.00~99.99 Ω	0.00	
↗2-06	Motor Rated Slip	0.00 to 20.00 Hz	3.00	
2-07	Slip Compensation Limit	0 to 250%	200	
↗2-08	Torque Compensation Time Constant	0.01 to 10.00 Sec	0.05	
↗2-09	Slip Compensation Time Constant	0.01 to 10.00 Sec	0.10	

Parameter	Explanation	Settings	Factory Setting	Customer
↯2-10	Compensation Coefficient for Motor Instability	00 to 16	07	
2-11	PG Pulse Range	00 to 4000	600	
2-12	PG Input	00: Disable 01: Forward / CCW rotation (A phase leads B phase) 02: Forward / CCW rotation (B phase leads A phase)	00	
2-13	Electrical Gear A	01 to 5000	100	
2-14	Electrical Gear B	01 to 5000	100	
↯2-15	ASR (Auto Speed Regulation for door open) control (with PG only) (P)	0.0 to 10.0	0.5	
↯2-16	ASR (Auto Speed Regulation for door open) control (with PG only) (I)	0.00 to 100.00 (0.00 disable)	1.00	
2-17	PG Slip Compensation Limit	0.00 to 60.00 Hz	20.00	
↯2-18	Deviation Range of PG Feedback Signal Error	0.01 to 100 Hz	3.00	
2-19	PG Feedback Signal Detection Time	0.0 to 100.0 sec	1.0	
↯2-20	Treatment of the Erroneous PG Feedback Signals	00: Warn and keep operation 01: Fault and RAMP to stop 02: Warn and low speed operation	02	
↯2-21	Sample time for refreshing the content of 210DH and 210EH	0.01 to 1.00 sec	0.10	
↯2-22	Door Width Auto-tuning Frequency	0.10 to 1.00 sec	0.10	
2-23	Door Width Auto-tuning Function	00: disable 01: enable	00	
2-24	Door Width Pulses (Unit: 1)	01 to 9999	7500	
2-25	Door Width Pulses (Unit: 10000)	00 to 99	00	
2-26	Reserved			
2-27	Reserved			
↯2-28	ASR (Auto Speed Regulation for door close) control (with PG only) (P)	0.0 to 10.0	0.5	

Parameter	Explanation	Settings	Factory Setting	Customer
↗2-29	ASR (Auto Speed Regulation for Door Close) control (with PG only) (I)	0.00 to 100.00 (0.00 disable)	1.00	

## Group 3 Door Open Parameters

Parameter	Explanation	Settings	Factory Setting	Customer
↗3-00	Door Open Coupling Speed	0.00 to 400.0Hz	8.40	
↗3-01	Door Open High Speed Start	00 to 65535 (Pluses number)	300	
↗3-02	Door Open High Speed 1	0.00 to 400.0Hz	42.00	
↗3-03	Door Open Final Speed Start	0.0 to 100.0%	95.0	
↗3-04	Door Open Final Speed	0.00 to 400.0Hz	5.00	
↗3-05	Door Open Holding Speed Start	0.0 to 100.0%	99.0	
↗3-06	Door Open Holding Speed	0.00 to 400.0Hz	2.00	
↗3-07	Door Open Acceleration Time 1	0.1 to 3600sec	2.0	
↗3-08	Door Open Deceleration Time 1	0.1 to 3600sec	2.0	
↗3-09	Door Open High Speed 2	0.00 to 400.0Hz	30.00	
↗3-10	Door Open Acceleration Time 2	0.1 to 3600sec	10.0	
↗3-11	Door Open Deceleration Time 2	0.1 to 3600sec	10.0	
↗3-12	Door Open Holding Torque	0.0 to 100.0%	30.0	
↗3-13	Response Time of Door Open Holding Torque	0.01 to 10.00sec	0.20	
3-14	Door Open Time-out Setting	0.0 to 180.0sec (0.0: disable)	0.0	
↗3-15	The Current Level 1 to Decrease to Pr.3-12 after Door Open Completed	0.0 to 150.0%	0.0%	
↗3-16	The Current Level 2 to Decrease to Pr.3-12 after Door Open Completed	0.0 to 150.0%	0.0%	
↗3-17	Holding Time for Terminal REV	0.0 to 999.9 sec (999.9 sec for always holding)	0.0	

Parameter	Explanation	Settings	Factory Setting	Customer
↗3-18	S Curve Acceleration Time for Door Open	0.0 to 10.0 sec	0.0	

#### Group 4 Door Close Parameters

Parameter	Explanation	Settings	Factory Setting	Customer
↗4-00	Door Close High Speed 1	0.00 to 400.0Hz	30.00	
↗4-01	Door Close Final Speed Start	0.0 to 100.0%	4.0	
↗4-02	Door Close Final Speed	0.00 to 400.0Hz	5.00	
↗4-03	Door Close Holding Speed Start	0.0 to 100.0%	1.0	
↗4-04	Door Close Holding Speed	0.00 to 400.0Hz	2.00	
↗4-05	Door Close Acceleration Time 1	0.1 to 3600sec	2.0	
↗4-06	Door Close Deceleration Time 1	0.1 to 3600sec	2.0	
↗4-07	Door Close High Speed 2	0.00 to 400.0Hz	20.00	
↗4-08	Door Close Acceleration Time 2	0.1 to 3600sec	10.0	
↗4-09	Door Close Deceleration Time 2	0.1 to 3600sec	10.0	
↗4-10	Re-open Current Level 1	0.0 to 150.0%	100.0	
4-11	Re-open Current Level 1 for Acceleration Area	100~200% (100% is Pr.4-10 setting)	150	
↗4-12	Re-open Current Level 2	0.0 to 150.0%	100.0	
4-13	Re-open Current Level 2 for Acceleration Area	100~200% (100% is Pr.4-12 setting)	150	
↗4-14	Re-open Deceleration Time	0.1 to 3600sec	0.2	
↗4-15	Door Close Holding Torque	0.0 to 100.0%	30.0	
↗4-16	Response Time of Door Close Holding Torque	0.01 to 10.00sec	0.20	
↗4-17	Re-open Low Speed Area	1.0 to 99.0% (100% is the door width, low speed area is 0%~Pr. 4-17)	2.0	
↗4-18	Re-open Acceleration Boundary	8.0 to 97.0% (100% is the door width, acceleration area is Pr. 4-18~100%)	70.0	

Parameter	Explanation	Settings	Factory Setting	Customer
4-19	Door Close Time-out Setting	0.0 to 180.0sec (0.0: disable)	0.0	
↗4-20	The Current Level 1 to Decrease to Pr.4-15 after Door Close	0.0~150.0%	0.0	
↗4-21	The Current Level 2 to Decrease to Pr.4-15 after Door Close	0.0~150.0%	0.0	
↗4-22	Holding Time for Terminal FWD	0.0 to 999.9 sec (999.9 sec for always holding)	0.0	
↗4-23	S Curve Acceleration Time for Door Close	0.0 to 10.0 sec	0.0	
↗4-24	Re-open Current Level 1 for Low Speed	0.0~150.0%	100.0	
↗4-25	Re-open Current Level 2 for Low Speed	0.0~150.0%	100.0	

## Group 5 Multi-Step Speed and PLC Parameters

Parameter	Explanation	Settings	Factory Setting	Customer
5-00	Multi-Function Input Terminal (MI1)	00: No function	00	
5-01	Multi-Function Input Terminal (MI2)	01: Multi-step speed command 1 02: Multi-step speed command 2 03: Multi-step speed command 3 04: Multi-step speed command 4	00	
5-02	Multi-Function Input Terminal (MI3)	05: 1st/2nd Accel/decel Time Selection 06: Low speed operation	00	
5-03	Multi-Function Input Terminal (MI4)	07: FWD/REV command for low speed operation	00	
5-04	Multi-Function Input Terminal (MI5)	08: Demo mode 09: Force stop (NO) 10: Force stop (NC)	00	
5-05	Multi-Function Input Terminal (A)	11: Emergency stop (NO) 12: Emergency stop (NC)	00	
5-06	Multi-Function Input Terminal (B)	13: Operation command selection (Keypad/external terminal)	00	
5-07	Multi-Function Input Terminal (COM1)	14: Parameter lock enable (NC) 15: Reset (NO) 16: Reset (NC)	00	
5-08	Multi-Function Input Terminal (COM2)	17: The signal when it is in open completed position	00	
5-09	Multi-Function Input Terminal (COM3)	18: The signal when it is in close completed position	00	
5-10	Multi-Function Input Terminal (COM4)	19: Open allowance signal 20: Force door open signal 21: Home return	00	

Parameter	Explanation	Settings	Factory Setting	Customer
		22: The curve selection for 1st/2nd step door open/close 23: The signal when it is in open completed position, including RUN signal 24: The signal when it is in close completed position, including RUN signal		
5-11	Line Start Lockout	00: Disable 01: Enable	00	
5-12	2-wire/3-wire Operation Control Mode	00: 2-wire (FWD/STOP, REV/STOP) 01: 2-wire (FWD/REV, RUN/STOP) 02: 3-wire operation control	00	
5-13	Digital Terminal Input Debouncing Time	01 to 20 (*2.5ms)	01	
↗5-14	Waiting Time for Next Demo	0.1 to 999.9sec	2.0	
5-15	The Record for Demo Times	00 to 9999	00	
5-16	Clear Demo Times	00: Disable 01: Enable	00	
↗5-17	1 <sup>st</sup> Step Speed Frequency	0.00 to 400.0 Hz	0.00	
↗5-18	2 <sup>nd</sup> Step Speed Frequency	0.00 to 400.0 Hz	0.00	
↗5-19	3 <sup>rd</sup> Step Speed Frequency	0.00 to 400.0 Hz	0.00	
↗5-20	4 <sup>th</sup> Step Speed Frequency	0.00 to 400.0 Hz	0.00	
↗5-21	5 <sup>th</sup> Step Speed Frequency	0.00 to 400.0 Hz	0.00	
↗5-22	6 <sup>th</sup> Step Speed Frequency	0.00 to 400.0 Hz	0.00	
↗5-23	7 <sup>th</sup> Step Speed Frequency	0.00 to 400.0 Hz	0.00	
↗5-24	8 <sup>th</sup> Step Speed Frequency	0.00 to 400.0 Hz	0.00	
↗5-25	9 <sup>th</sup> Step Speed Frequency	0.00 to 400.0 Hz	0.00	
↗5-26	10 <sup>th</sup> Step Speed Frequency	0.00 to 400.0 Hz	0.00	
↗5-27	11 <sup>th</sup> Step Speed Frequency	0.00 to 400.0 Hz	0.00	
↗5-28	12 <sup>th</sup> Step Speed Frequency	0.00 to 400.0 Hz	0.00	
↗5-29	13 <sup>th</sup> Step Speed Frequency	0.00 to 400.0 Hz	0.00	
↗5-30	14 <sup>th</sup> Step Speed Frequency	0.00 to 400.0 Hz	0.00	
↗5-31	15 <sup>th</sup> Step Speed Frequency	0.00 to 400.0 Hz	0.00	
↗5-32	16 <sup>th</sup> Step Speed Frequency	0.00 to 400.0 Hz	0.00	



Parameter	Explanation	Settings	Factory Setting	Customer
5-33	Multi-function Input Terminal Status (N.O/N.C)	0~8191	0	
5-34	Reset after re-open/re-close	Bit0=0: Disable to detect the incorrect open/close limit Bit0=1: Enable to detect the incorrect open/close limit Bit1=0: Enable to re-open when door close error Bit1=1: Disable to re-open when door close error Bit2=0: Enable S-Curve when re-open Bit2=1: Disable S-Curve when re-open Bit3=0: Disable to reset door width to 100.0% after door open completed Bit3=1: Enable to reset door width to 100.0% after door open completed	00	

## Group 6 Digital Output Parameters

Parameter	Explanation	Settings	Factory Setting	Customer
↗6-00	Multi-function Output (RA1, RB1, RC1)	00: No function	00	
↗6-01	Multi-function Output (RA2, RC2)	01: AC drive operational		
↗6-02	Multi-function Output MO1 (communication)	02: Master frequency attained 03: Over-Torque Detection		
↗6-03	Multi-function Output MO2 (communication)	04: Low-Voltage Indication 05: Operation Mode Indication 06: Fault Indication		
↗6-04	Multi-function Output MO3 (communication)	07: Warning Indication 08: Demo Indication 09: A Step Completed		
↗6-05	Multi-function Output MO4 (communication)	10: A Demo Completed 11: Forced Stop Indication 12: Heat Sink Overheat Warning		
↗6-06	Multi-function Output MO5 (communication)	13: AC Drive Ready 14: Emergency Stop 15: Soft Brake Signal		
↗6-07	Multi-function Output MO6 (communication)	16: Zero Speed Output Signal 17: Feedback Signal Error 18: Position Detection 1 (both door open and close) 19: Position Detection 2 (both door open and close) 20: Position Detection 3 (both door open and close) 21: The signal outputs when it is in close completed position 22: The signal outputs when it is in open completed position 23: Door Close Error 24: Reserved	00	

Parameter	Explanation	Settings	Factory Setting	Customer
		25: Position Complete Signal 26: Reserved 27: Position Detection 1 (door close only) 28: Position Detection 2 (door close only) 29: Position Detection 3 (door close only) 30: Position Detection 1 (door open only) 31: Position Detection 2 (door open only) 32: Position Detection 3 (door open only)		
↗6-08	Multi-function Output status	00 to 255	00	
↗6-09	Position Detection 1	0.0 to 100.0%	25.0	
↗6-10	Position Detection 2	0.0 to 100.0%	12.5	
↗6-11	Position Detection 3	0.0 to 100.0%	7.5	
6-12 ~ 6-15	Reserved			

### Group 7 Protection and Special Parameters

Parameter	Explanation	Settings	Factory Setting	Customer
↗7-00	Software Brake Level	370~430 Vdc	380	
7-01	DC Brake Current Level	0.0 to 100.0 %	0.0	
7-02	DC Brake Time during Start-Up	0.0 to 999.9 sec	0.0	
7-03	DC Brake Time during Stopping	0.0 to 999.9 sec	0.0	
7-04	Start-Point for DC Brake	0.00 to 400.0Hz	0.00	
7-05	Over-Torque Detection Mode	00: Disabled 01: Enabled during constant speed operation and continues until oL/oL1 is reached. 02: Enabled during constant speed operation and halted after oL2 detection 03: Enabled during Accel/constant speed operation and continues until oL/oL1 is reached 04: Enabled during Accel/constant speed operation and halted after oL2 detection	00	
7-06	Over-Torque Detection Level	10.0 to 200.0%	150.0	
7-07	Over-Torque Detection Time	0.1 to 60.0 sec	0.1	
7-08	Electronic Thermal Overload Relay Selection	00: Standard Motor 01: Special Motor 02: Disabled	01	
7-09	Electronic Thermal Characteristic	30 to 600 sec	60	

Parameter	Explanation	Settings	Factory Setting	Customer
7-10	Auto Restart After Fault	00 to 10	06	
7-11	Delay Time for Speed Search	0.1 to 600.0 sec	2.0	
7-12	Current Limit for Speed Search	20.0 to 200.0%	150.0	
7-13	Speed Trace at Restart after Fault	00: Speed search starts with the Master Frequency reference value 01: Starts with the minimum output frequency	01	
7-14	Auto Reset Time at Restart after Fault	00 to 9999sec	600	
7-15	Present Fault Record	00: No fault 01: Over Current (oc) 02: Over Voltage (ov) 03: Overheat (oH) 04: Overload (oL) 05: Overload (oL1) 06: External Fault (EF) 07: Reserved	00	
7-16	Second Most Recent Fault Record	08: CPU failure (cF3) 09: Hardware Protection Failure (HPF) 10: Current exceed during Acceleration (ocA) 11: Current exceed during Deceleration (ocd) 12: Current exceed during Steady State (ocn) 13: Ground Fault (GFF) 14: Reserved	00	
7-17	Third Most Recent Fault Record	15: CPU READ failure (CF1) 16: CPU WRITE failure (CF2) 17: Reserved 18: Motor overload (oL2) 19: Reserved	00	
7-18	Fourth Most Recent Fault Record	20: Software/password protection (PcdE/Ccde) 21: Reserved 22: Reserved 23: Reserved 24: Reserved 25: Reserved 26: PG feedback error (PGEr) 27: Door open/close complete signal error (PSEr) 28: Door open time-out ( eca) 35: Communication time-out (CE10)	00	
7-19	Accumulative Motor Operation Time (Min.)	00 to 1439 min	00	
7-20	Accumulative Motor Operation Day	00 to 9999 day	00	

Parameter	Explanation	Settings	Factory Setting	Customer
7-21	Deceleration Method for Emergency Stop/Forced Stop	00: According to the fast deceleration time (Pr.4-14) 01: According to door open/close deceleration time 1 (Pr.3-08/4-06) 02: According to door open/close deceleration time 2 (Pr.3-11/4-09) 03: According to DC brake time during stopping 04: Free run to stop	00	

## Group 8 Communication Parameters

Parameter	Explanation	Settings	Factory Setting	Customer
↯ 8-00	Communication Address	01 to 254	01	
↯ 8-01	Transmission Speed	00: Baud rate 4800bps 01: Baud rate 9600bps 02: Baud rate 19200bps 03: Baud rate 38400bps	02	
↯ 8-02	Transmission Fault Treatment	00: Warn and keep operating 01: Warn and ramp to stop 02: Warn and coast to stop 03: No warning and keep operating	03	
↯ 8-03	Time-out Detection	0.0 ~ 60.0 seconds (0.0: Disable)	0.0	
↯ 8-04	Communication Protocol	00: 7,N,2 (Modbus, ASCII) 01: 7,E,1 (Modbus, ASCII) 02: 7,O,1 (Modbus, ASCII) 03: 8,N,2 (Modbus, RTU) 04: 8,E,1 (Modbus, RTU) 05: 8,O,1 (Modbus, RTU)	03	
↯ 8-05	Response Delay Time	00 ~ 200 msec	00	

## 4.2 Description of Parameter Settings

### Group 0: User Parameters

↗: The parameter can be set during

operation. ↗: This parameter can be set during operation.

<b>0 – 00</b>	Identity Code of the AC Motor Drive				
	Settings	Read Only			Factory setting: ##
<b>0 – 01</b>	Rated Current Display of the AC Motor Drive				
	Settings	Read Only			Factory setting: ##

 Pr. 0-00 displays the identity code of the AC motor drive. The capacity, rated current, rated voltage and the max. carrier frequency relate to the identity code. Users can use the following table to check how the rated current, rated voltage and max. carrier frequency of the AC motor drive correspond to the identity code.

 Pr.0-01 displays the rated current of the AC motor drive. By reading this parameter the user can check if the AC motor drive is correct.

230V Series	kW	HP	Pr.0-00	Rated Output Current (A)	Max. Carrier Frequency
	0.4	0.5	00	2.5	15KHz

<b>0 – 02</b>	Parameter Reset				Factory Setting: 00
	Settings	08 Keypad Lock			
		09 All parameters are reset to factory settings (50Hz, 230V)			
		10 All parameters are reset to factory settings (60Hz, 220V)			

 This parameter allows the user to reset all parameters to the factory settings except the fault records (Pr.7-15 ~ Pr.7-18).

50Hz: Pr.1-01 is set to 50Hz and Pr.1-02 is set to 230V.

60Hz: Pr.1-01 is set to 60Hz and Pr.1-02 is set to 230V.

 When Pr.0-02=08, the keypad is locked. To unlock the keypad, set Pr.0-02=00.

**0 – 03** Start-up Display Selection















Factory Setting: 00

- Settings 00 Display the frequency command value. (F)  
 01 Display the actual output frequency (H)  
 02 Display the content of user-defined unit (U)  
 03 Multifunction display, see Pr.0-04  
 04 FWD/REV command

 This parameter determines the start-up display page after power is applied to the drive.

**0 – 04** Content of Multi-Function Display

Factory Setting: 00

- |             |   |   |
|-------------|---|---|
| Settings 00 | Display the output current in A supplied to the motor   |    |
| 01          | Display the pulses  |    |
| 02          | Display the walking distance and step speed (x.yy.y)  |    |
| 03          | Display the actual DC BUS voltage in VDC of the AC motor drive  |    |
| 04          | Display the output voltage in VAC of terminals U, V, W to the motor.                                    |    |
| 05          | Display the power factor angle in ° of terminals U, V, W to the motor.                                  |    |
| 06          | Display the output power in kW of terminals U, V and W to the motor.                                    |    |
| 07          | Display the actual motor speed in rpm (enabled in vector control mode or PG (Encoder) feedback control) |    |
| 08          | Display the estimated value of torque in Nm as it relates to current.                                   |   |
| 09          | Display PG encoder feedback pulses/10ms.<br>Display value= (rpm*PPR)/6000 (see note)                    |  |
| 10          | Display the temperature of heat sink in °C.   |  |
| 11          | Display external input terminal status (I.)   |  |
| 12          | Display external output terminal status (o.)  |  |
| 13          | Display communication address (d.)  |  |

 This parameter sets the display when Pr. 0-03 is set to 03.

Setting 09: the display value is  $[(\frac{rpm}{60} \times PPR)/1000] \times 10 = \text{Pulse}/10\text{ms}$

with rpm=motor speed in revs/min; PPR=encoder pulse per revolution; 1000 (1 sec=1000ms); 10: encoder pulse per 10ms.

When the display shows the multi-function display (Pr.0-03=03), the user also can view other information by pressing the “UP” key  $\blacktriangle$  on the keypad.

Setting 11: It is used to display the status of the external multi-function input terminals, including MI1~MI5, FWD and REV. The value it displays is hexadecimal number. It needs to be converted to binary to get the result as following diagram.

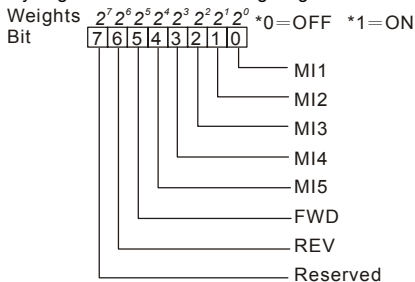

For example: when it displays I. 52. After converting 52(HEX) to binary (01010010), it indicates that the terminals MI2, MI5 and REV are ON.

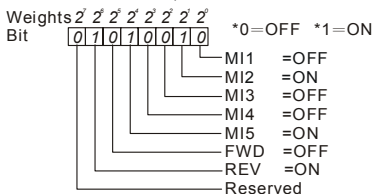

The display value

$$\begin{aligned}
 &= \text{bit}7 \times 2^7 + \text{bit}6 \times 2^6 + \text{bit}5 \times 2^5 + \text{bit}4 \times 2^4 + \text{bit}3 \times 2^3 + \text{bit}2 \times 2^2 + \text{bit}1 \times 2^1 + \text{bit}0 \times 2^0 \\
 &= 0 \times 2^7 + 1 \times 2^6 + 0 \times 2^5 + 1 \times 2^4 + 0 \times 2^3 + 0 \times 2^2 + 1 \times 2^1 + 0 \times 2^0 \\
 &= 0 + 64 + 0 + 16 + 0 + 0 + 2 + 0 \\
 &= 82 = 52 \text{ (H)}
 \end{aligned}$$

NOTE:

$2^7=1$	$2^6=8$	$2^5=64$
$2^4=2$	$2^3=16$	$2^2=128$
$2^1=4$	$2^0=32$	

Setting 12: It is used to display the status of the external multi-function output terminals, including relay1, relay2, MO1 and MO2. The value it displays is hexadecimal number. It needs to be converted to binary to get the result as following diagram.

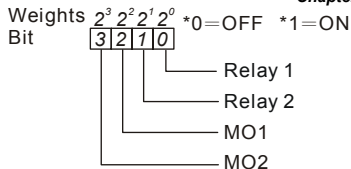

For example: when it displays o. C. After converting C(HEX) to binary (1100), it indicates that the terminals MO1 and MO2 are ON.

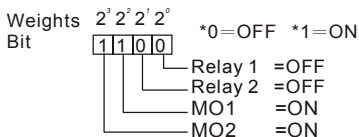

The display value

$$\begin{aligned}
 &= \text{bit}3 \times 2^3 + \text{bit}2 \times 2^2 + \text{bit}1 \times 2^1 + \text{bit}0 \times 2^0 \\
 &= 1 \times 2^3 + 1 \times 2^2 + 0 \times 2^1 + 0 \times 2^0 \\
 &= 8 + 4 + 0 + 0 \\
 &= 12 = \text{C (H)}
 \end{aligned}$$

NOTE:

$$\begin{aligned}
 2^0 &= 1 & 2^3 &= 8 & 2^2 &= 4 \\
 2^1 &= 2 & 2^4 &= 16 & 2^3 &= 128 \\
 2^2 &= 4 & 2^5 &= 32 & &
 \end{aligned}$$

#### 0-05 User Defined Coefficient K

Unit: 0.1

Settings 0.1 to 160.0

Factory Setting: 1.0

The coefficient K determines the multiplying factor for the user-defined unit.

The display value is calculated as follows:

$$U \text{ (User-defined unit)} = \text{Frequency Command} * K \text{ (Pr.0-05)}$$

$$H \text{ (actual output)} = \text{Actual output frequency} * K \text{ (Pr.0-05)}$$

Example:

A conveyor belt runs at 13.6m/s at motor speed 60Hz.

$K = 13.6/60 = 0.21$  (0.226667 rounded to 1 decimal), therefore Pr. 0-05=0.2

With Frequency command 35Hz, display shows U and  $35 * 0.2 = 7.0\text{m/s}$ .

(To increase accuracy, use  $K=2.2$  or  $K=22.7$  and disregard decimal point.)

#### 0-06 Software Version

Settings Read Only



Display ##



<b>0 – 07</b>	✓ Password Input	Unit: 1
Settings	00 to 9999	Factory Setting: 00
Display	00~02 (times of wrong password)	

-  The function of this parameter is to input the password that is set in Pr.0-08. Input the correct password here to enable changing parameters. You are limited to a maximum of 3 attempts. After 3 consecutive failed attempts, a blinking “PcdE” will show up to force the user to restart the AC motor drive in order to try again to input the correct password.

<b>0 – 08</b>	✓ Password Set	Unit: 1
Settings	00 to 9999	Factory Setting: 00
Display	00	No password set or successful input in Pr. 0-07
	01	Password has been set

-  To set a password to protect your parameter settings.
- If the display shows 00, no password is set or password has been correctly entered in Pr.0-07. All parameters can then be changed, including Pr.0-08.
- The first time you can set a password directly. After successful setting of password the display will show 01.
- Be sure to record the password for later use.
- To cancel the parameter lock, set the parameter to 00 after inputting correct password into Pr. 0-07.
- The password consists of min. 1 digit and max. 4 digits.
-  How to make the password valid again after decoding by Pr.0-07:
- Method 1: Re-input original password into Pr.0-08 (Or you can enter a new password if you want to use a changed or new one).
- Method 2: After rebooting, password function will be recovered.

## Password Decode Flow Chart

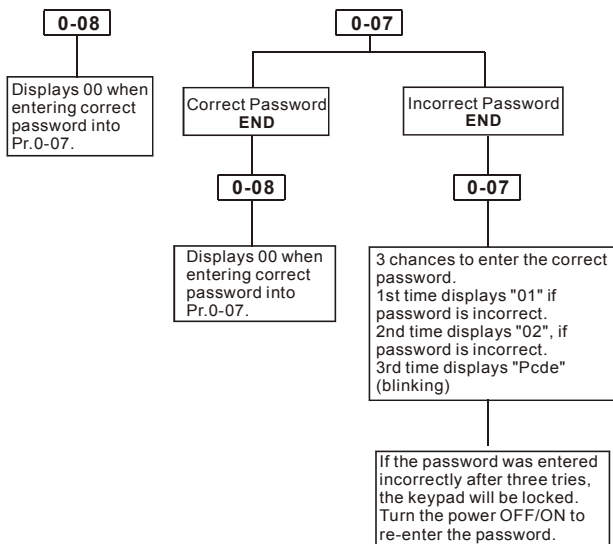

## 0 - 09 Door Control Mode

Factory Setting: 00

Settings	00	Distance control mode 1
	01	Distance control mode 2
	02	Multi-step control mode 1
	03	Multi-step control mode 2
	04	Multi-step control mode 3
	05	Multi-step control mode 4

This parameter is used to select the control mode of AC motor drives. Refer to the following explanation for detail.

00 Distance control mode 1

The drive is controlled by sensorless control. It should be set the Pr.2-11~Pr.2-14 correctly. It will store the door width in Pr.2-24 and Pr.2-25 by Auto-tuning. It operates the door for speed switch and completed position by counting the PG pulses. In this mode, position function will be executed whenever power again and operates with low speed to the 0% or 100% door width by the operation direction.

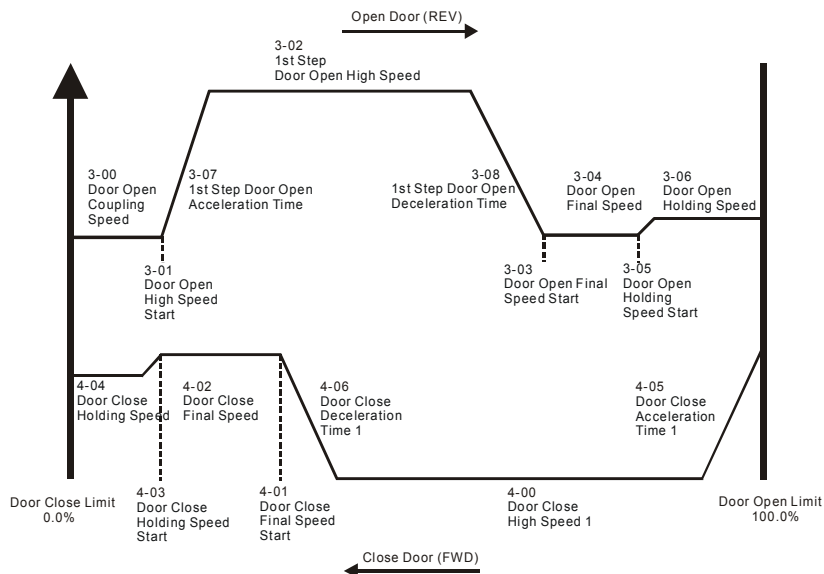

#### 01 Distance control mode 2

This function is the same as "00 distance control mode 1". The difference is using PG to control the speed. Refer to the following diagram for detail. In this mode, position function will be executed whenever power again and operates with low speed to the 0% or 100% door width by the operation direction.

#### 02 Multi-step control mode 1

The drive is controlled by sensorless control. For operating the door, it uses four multi-input (level trigger) for speed switch and limit switches for completed position.

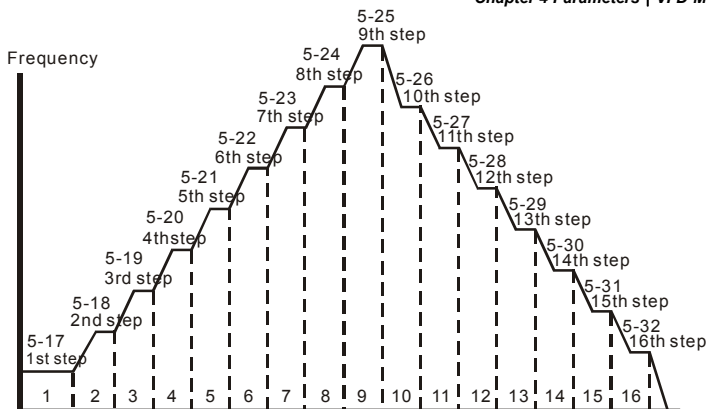

### 03 Multi-step control mode 2

The drive is controlled by sensorless control. For operating the door, it uses three multi-input (level trigger) and operation direction (FWD/REV) to deal with speed switch and limit switch to deal with completed position. (4<sup>th</sup> logic signal: open: 0, close: 1)

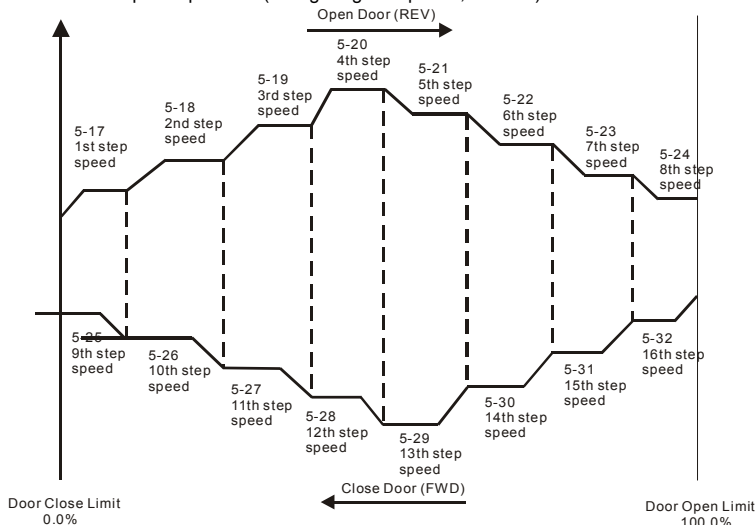

### 04 Multi-step control mode 3

The drive is controlled by sensorless control. For operating the door, it switches speed by external signal and uses limit switch to deal with completed position. The signals must be edge trigger. In this mode, it needs to run the door to the close complete position after power on again or AC motor drive stops.

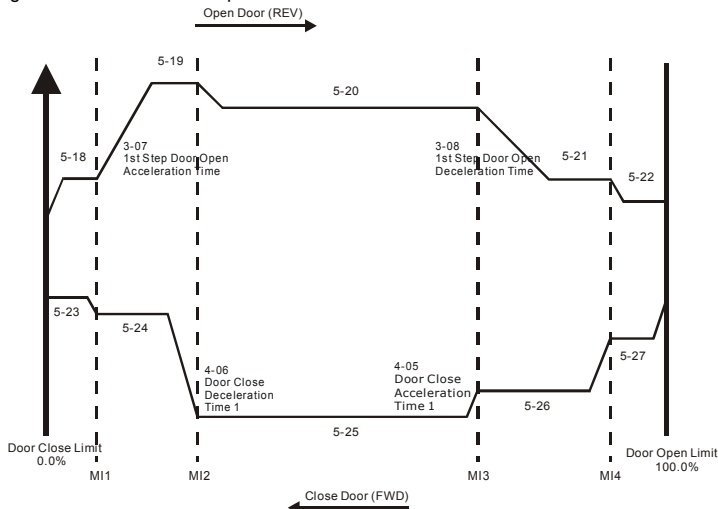

### 05 Multi-step control mode 4

The speed curve is the same as multi-speed step mode 3, but the speed switch signals are level trigger. In this mode, it can switch speed without detecting speed switch limit to run to the door close complete position after power on again.

### Comparison Table

	Advantage	Disadvantage
00 Distance control mode 1	Uses PG signal to distinguish the position for speed switch without sensor.	It depends on PG signal highly. It will cause pulse loss or wrong position for speed switch when getting error PG signal.
01 Distance control mode 2	Uses PG signal to distinguish the position for speed switch without sensor and control output frequency precisely.	It will cause incorrect output frequency due to inaccurate PG feedback signal or low PG resolution.
02 Multi-step control mode 1	Uses four multi-input signal for switching 16-step speed. That means it has 16-step speed for single direction.	It needs to have sensor and external controller to distinguish operation direction.

	Advantage	Disadvantage
03 Multi-step control mode 2	Uses three multi-input signal and operation direction for switching 16-step speed. It doesn't need external controller to distinguish operation direction.	It needs to have sensor. To compare with "02 multi-step control mode 1", it only has 8-step speed for the single direction.
04 Multi-step control mode 3	Uses edge trigger for speed switch. It has 5-step speed for the single direction to simplify the detection of the position sensor.	There is only 5-step speed for the single direction. It needs to run to the close complete position after power on again or AC motor drive stops due to the edge trigger.
05 Multi-step control mode 4	Uses level trigger for speed switch. It has 5-step speed for the single direction to simplify the detection of the position sensor.	There is only 5-step speed for the single direction.

**0 – 10** PWM Carrier Frequency Selection



Unit: 1

Settings 01 to 15kHz

Factory Setting: 12

230V Series	Power	Setting Range	Factory Setting
	0.5HP (0.4kW)	01~15kHz	12kHz

 This parameter determines the PWM carrier frequency of the AC motor drive.



Carrier Frequency	Acoustic Noise	Electromagnetic Noise or leakage current	Heat Dissipation	Current Wave
1kHz	Significant	Minimal	Minimal	 Minimal
8kHz	↑ ↓	↑ ↓	↑ ↓	
15kHz				

 From the table, we see that the PWM carrier frequency has a significant influence on the electromagnetic noise, AC motor drive heat dissipation, and motor acoustic noise.

**0 – 11** Automatic Voltage Regulation (AVR)

Factory Setting: 00

Settings	00	AVR function enabled
	01	AVR function disabled
	02	AVR function disabled for deceleration

-  The rated voltage of the motor is usually AC220V/200V 60Hz/50Hz and the input voltage of the AC motor drive may vary between 180V to 264 VAC 50Hz/60Hz. Therefore, when the AC motor drive is used without AVR function, the output voltage will be the same as the input voltage. When the motor runs at voltages exceeding the rated voltage with 12% - 20%, its lifetime will be shorter and it can be damaged due to higher temperature, failing insulation and unstable torque output.
-  AVR function automatically regulates the AC motor drive output voltage to the Maximum Output Voltage (Pr.1-02). For instance, if Pr.1-02 is set at 200 VAC and the input voltage is at 200V to 264VAC, then the Maximum Output Voltage will automatically be reduced to a maximum of 200 VAC.
-  When motor stops with deceleration, it will shorten deceleration time. When setting this parameter to 02 with auto acceleration/deceleration, it will offer a quicker deceleration.

---

**0 – 12** ✓ Source of the Operation Command
 

---

Factory Setting: 00

Settings	00	Digital keypad
	01	External terminals. Keypad STOP enabled.
	02	External terminals. Keypad STOP disabled.
	03	RS-485 serial communication (RJ-11). Keypad STOP enabled.
	04	RS-485 serial communication (RJ-11). Keypad STOP disabled.

---

-  This parameter is used to set the source of the operation command.

---

**0 – 13** Stop Method
 

---

Factory Setting: 00

Settings	00	Ramp to stop
	01	Coast to stop

---

-  The parameter determines how the motor is stopped when the AC motor drive receives a valid stop command or detects External Fault.
1. Ramp: the AC motor drive decelerates to Minimum Output Frequency (Pr.1-05) according to the deceleration time and then stops.
  2. Coast: the AC motor drive stops the output instantly upon command, and the motor free runs until it comes to a complete standstill.
  3. The motor stop method is usually determined by the characteristics of the motor load and how frequently it is stopped.

- (1) It is recommended to use "ramp to stop" for safety of personnel or to prevent material from being wasted in applications where the motor has to stop after the drive is stopped. The deceleration time has to be set accordingly.
- (2) If the motor free running is allowed or the load inertia is large, it is recommended to select "coast to stop".

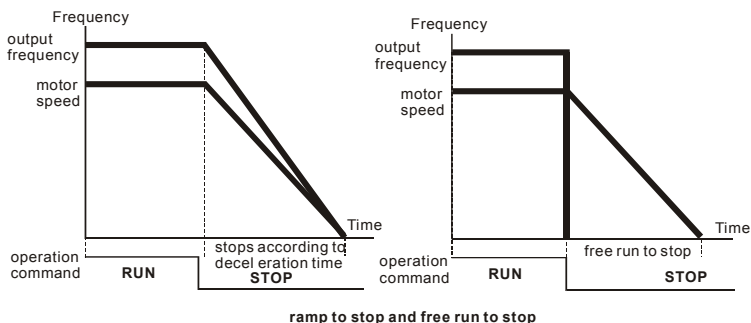

#### 0 – 14 Door Open/Close Control

Factory Setting: 00

Settings	00	Enable door open/close operation
	01	Disable door open operation
	02	Disable door close operation

#### 0 – 15 Position Mode

Factory Setting: 00

Settings	00	No limit signal, detected by PG number or current level
	01	Door open limit signal only, door close limit is detected by PG number or current level
	02	Door close limit signal only, door open limit is detected by PG number or current level
	03	Door open and close limit signal
	04	Detect by PG number and also accept external door open/close limit signal



When this parameter is **NOT** set to 00 "No limit signal" and Pr. 0-17 is **NOT** set to 0, it will be regarded as open/close complete position with following two conditions.

- A. It has open/close limit signal.
- B. When the current exceeds this level due to motor stall.



 When this parameter is set to 00 “No limit signal”, the methods for detecting open/close complete position are as follows.

A. When Pr. 0-17 is set to 0: When PG feedback frequency is almost 0 due to motor stall, it is regarded as open/close complete position.

B. When Pr. 0-17 is **NOT** set to 0: When current exceeds this level due to motor stall, it is regarded as open/close complete position.

### NOTE

It is recommended to use method B for the transmission mechanism skids easily.

This function is only for the distance control mode. For multi-step control mode, please use the multi-input terminals (set one of Pr.5-00~Pr.5-10 to 17, 18, 23 or 24).

<b>0 – 17</b>	 Stall Current Level of Position Mode	Unit: 0.1
Settings	0.0 to 200.0%	Factory Setting: 30.0

 This parameter is used for the stall current level for open/close complete position and used with Pr.0-15.

<b>0 – 16</b>	Fan Control	Factory Setting: 03
Settings	00 Fan always ON	
	01 1 minute after AC motor drive stops, fan will be OFF	
	02 AC motor drive runs and fan ON, AC motor drive stops and fan OFF	
	03 Fan ON to run when preliminary heatsink temperature attained	

 This parameter determines the operation mode of cooling fan.

<b>0 – 18</b>	Control Method	Factory Setting: 00
Settings	00 V/F control	
	01 Vector Control	

 This parameter determines the control method of the AC motor drive.

**Group 1: Basic Parameters**

<b>1 – 00</b>	Maximum Output Frequency (Fmax)	Unit: 0.01
Settings	50.00 to 400.0 Hz	Factory Setting: 60.00

 This parameter determines the AC motor drive's Maximum Output Frequency.

<b>1 – 01</b>	Maximum Voltage Frequency (Fbase)	Unit: 0.01
Settings	0.10 to 400.0Hz	Factory Setting: 60.00

 This value should be set according to the rated frequency of the motor as indicated on the motor nameplate. Maximum Voltage Frequency determines the v/f curve ratio. This parameter value must be equal to or greater than the Mid-Point Frequency (Pr.1-03).

<b>1 – 02</b>	Maximum Output Voltage (Vmax)	Unit: 0.1
Settings	230V series 0.1 to 255.0V	Factory Setting: 220.0

 This parameter determines the Maximum Output Voltage of the AC motor drive. The Maximum Output Voltage setting must be smaller than or equal to the rated voltage of the motor as indicated on the motor nameplate. This parameter value must be equal to or greater than the Mid-Point Voltage (Pr.1-04).

<b>1 – 03</b>	Mid-Point Frequency (Fmid)	Unit: 0.01
Settings	0.10 to 400.0Hz	Factory Setting: 0.50

 This parameter sets the Mid-Point Frequency of the V/f curve. With this setting, the V/f ratio between Minimum Frequency and Mid-Point frequency can be determined. This parameter must be equal to or greater than Minimum Output Frequency (Pr.1-05) and equal to or less than Maximum Voltage Frequency (Pr.1-01).

<b>1 – 04</b>	Mid-Point Voltage (Vmid)	Unit: 0.1
Settings	230V series 0.1 to 255.0V	Factory Setting: 1.7

 This parameter sets the Mid-Point Voltage of any V/f curve. With this setting, the V/f ratio between Minimum Frequency and Mid-Point Frequency can be determined. This parameter must be equal to or greater than Minimum Output Voltage (Pr.1-06) and equal to or less than Maximum Output Voltage (Pr.1-02).

<b>1 – 05</b>	Minimum Output Frequency (Fmin)	Unit: 0.01
Settings	0.10 to 400.0Hz	Factory Setting: 0.50

 This parameter sets the Minimum Output Frequency of the AC motor drive. This parameter must be equal to or less than Mid-Point Frequency (Pr.1-03).

 The settings of 1-03, 1-04, and 1-06 are invalid in Vector Control mode.

<b>1 – 06</b>	Minimum Output Voltage (Vmin)	Unit: 0.1
Settings	230V series      0.1 to 255.0V	Factory Setting: 1.7

 This parameter sets the Minimum Output Voltage of the AC motor drive. This parameter must be equal to or less than Mid-Point Voltage (Pr.1-04).

 The settings of Pr.1-01 to Pr.1-06 have to meet the condition of  $Pr.1-02 \geq Pr.1-04 \geq Pr.1-06$  and  $Pr.1-01 \geq Pr.1-03 \geq Pr.1-05$ .

<b>1 – 07</b>	 Frequency Setting for Low Speed Operation	Unit: 0.1
Settings	0.10 Hz to 400.0 Hz	Factory Setting: 4.00

<b>1 – 08</b>	 Acceleration Time for Low Speed Operation	Unit: 0.1
Settings	0.1 to 3600 sec	Factory Setting: 2.0

<b>1 – 09</b>	 Deceleration Time for Low Speed Operation	Unit: 0.1
Settings	0.1 to 3600 sec	Factory Setting: 2.0

 When using low speed function, external terminals MI1~MI5 should be set to 8. When the low speed command is "ON", the AC motor drive will accelerate from Minimum Output Frequency (Pr.1-05) to Low Speed Frequency (Pr.1-07). When the low speed command is "OFF", the AC motor drive will decelerate from low speed Frequency to zero. The Accel/Decel time is set by the Accel/Decel time for low speed operation (Pr.1-08, Pr.1-09).

 Before using the Low speed command, the drive must be stopped first. And during Low Speed operation, other operation commands cannot be accepted, except command via the FORWARD, REVERSE and STOP keys on the digital keypad.

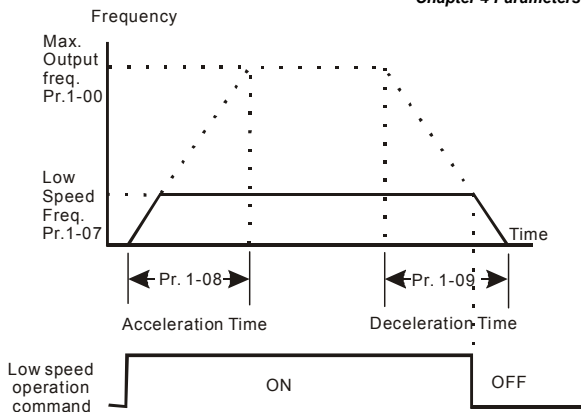

- It will run by these settings (Pr.1-07, Pr.1-08 and Pr.1-09) for position function (demo mode, power on position, position after PG error, position after limit switch error or input position signal again).

<b>1 – 10</b>	Skip Frequency 1 Upper Limit	Unit: 0.01
<b>1 – 11</b>	Skip Frequency 1 Lower Limit	Unit: 0.01
<b>1 – 12</b>	Skip Frequency 2 Upper Limit	Unit: 0.01
<b>1 – 13</b>	Skip Frequency 2 Lower Limit	Unit: 0.01
Settings	0.00 to 400.0Hz	Factory Setting: 0.00

- These parameters set the Skip Frequencies. It will cause the AC motor drive never to remain within these frequency ranges with continuous frequency output.

- These four parameters should be set as follows  $Pr.1-10 \geq Pr.1-11 \geq Pr.1-12 \geq Pr.1-13$ .

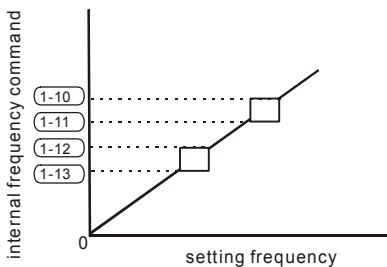

## Group 2: Motor and Feedback Function Parameters

<b>2 – 00</b>	Motor Parameters Auto Tuning	Unit: 1
		Factory Setting: 00
Settings	00 Disable	
	01 Auto Tuning R1 (motor doesn't run)	
	02 Auto Tuning R1 + No-load Test (with running motor)	

 Start Auto Tuning by pressing RUN key after this parameter is set to 01 or 02.

When set to 01, it will only auto detect R1 value and Pr.2-02 must be input manually. When set to 02, the AC motor drive should be unloaded and the values of Pr.2-02 and Pr.2-05 will be set automatically.

 The steps to AUTO-Tuning are:

1. Make sure that all the parameters are set to factory settings and the motor wiring is correct.
2. Make sure the motor has no-load before executing auto-tuning and the shaft is not connected to any belt or gear motor.
3. Fill in Pr.1-02, Pr.1-01, Pr.2-01 and Pr.2-06 with correct values.
4. After Pr.2-00 is set to 2, the AC motor drive will execute auto-tuning immediately after receiving a "RUN" command. (Note: The motor will run!). The total auto tune time will be around 15-20 seconds.
5. After executing, please check if there are values filled in Pr.2-02 and Pr.2-05. If not, please press RUN key after setting Pr.2-00 again.
6. Then you can set Pr.0-18 to 00/01 and set other parameters according to your application requirement.

 When executing auto tuning, the start/stop DC brake function is disabled.

### NOTE

It is not recommended to use vector control mode if motor rated power exceeds the rated power of the AC motor drive.

<b>2 – 01</b>	✓ Motor Rated Current	Unit: 0.1
Settings	FLA*5% to FLA*120%	Factory Setting: 2.50

 This parameter must set by the nameplate on the AC motor drive. The factory setting will be set by the rated current. Therefore, the factory setting is 100%\*FLA.

<b>2 – 02</b>	<b>↗ Motor No-load Current</b>	Unit: 0.1
Settings	0%*FLA to motor rated current	Factory Setting: 1.00

 The rated current of the AC drive is regarded as 100%. The setting of the Motor no-load current will affect the slip compensation.

 The setting value must be less than Pr.2-00 (Motor Rated Current).

<b>2 – 03</b>	<b>↗ Torque Compensation</b>	Unit: 0.1
Settings	0.0 to 10.0	Factory Setting: 1.0

 This parameter may be set so that the AC drive will increase its voltage output to obtain a higher torque. Only to be used for V/f control mode.

 Too high torque compensation can overheat the motor.

<b>2 – 04</b>	<b>Number of Motor Poles</b>	Unit: 2
Settings	02 to 16	Factory Setting: 04

 This parameter sets the number of motor poles (must be an even number).

<b>2 – 05</b>	<b>Motor Line-to-line Resistance R1</b>	Unit: 0.01
Settings	0.00 to 99.99 Ω	Factory Setting: 0.00

 The motor auto tune procedure will set this parameter. The user may also set this parameter without using Pr.2-05.

<b>2 – 06</b>	<b>↗ Motor Rated Slip</b>	Unit: 0.01
Settings	0.00 to 20.00Hz	Factory Setting: 3.00

 Refer to the rated rpm and the number of poles on the nameplate of the motor and use the following equation to calculate the rated slip.

$$\text{Rated Slip (Hz)} = F_{\text{base}} (\text{Pr.1-01 base frequency}) - (\text{rated rpm} \times \text{motor pole} / 120)$$

<b>2 – 07</b>	<b>Slip Compensation Limit</b>	Unit: 1
Settings	00 to 250%	Factory Setting: 200

 This parameter sets the upper limit of the compensation frequency (the percentage of Pr.2-06). Example: when Pr.2-06=5Hz and Pr.2-07=150%, the upper limit of the compensation frequency is 7.5Hz. Therefore, for a 50Hz motor, the max. output is 57.5Hz.

<b>2 – 08</b>	✓ Torque Compensation Time Constant	Unit: 0.01
Settings	0.01 ~ 10.00 sec	Factory Setting: 0.05
<b>2 – 09</b>	✓ Slip Compensation Time Constant	Unit: 0.01
Settings	0.01 ~ 10.00 sec	Factory Setting: 0.10

- Setting Pr.2-08 and Pr.2-09 changes the response time for the compensation.
- When Pr.2-08 and Pr.2-09 are set to 10.00 sec, its response time for the compensation will be the longest. But if the settings are too short, unstable system may occur.

<b>2 – 10</b>	✓ Compensation Coefficient for Motor Instability	Unit: 1
Settings	00~16	Factory Setting: 07

- The drift current will occur in a specific zone of the motor and it will make motor instable. By using this parameter, it will improve this situation greatly.
- The drift current zone of the big horsepower motor is usually in the low frequency area. It is recommended to set to 07.

<b>2 – 11</b>	PG Pulse Range	Unit: 1
Settings	00 ~ 4000	Factory Setting: 600

- A Pulse Generator (PG) or encoder is used as a sensor that provides a feedback signal of the motor speed. This parameter defines the number of pulses for each cycle of the PG control.
- The maximum pulse is 500kP/Sec and it supports two types, voltage output and open collector.

<b>2 – 12</b>	PG Input	Factory Setting: 00
Settings	00 Disable PG	
	01 Forward / CCW rotation (A phase leads B phase)	
	02 Forward / CCW rotation (B phase leads A phase)	

- The relationship between the motor rotation and PG input is illustrated below:

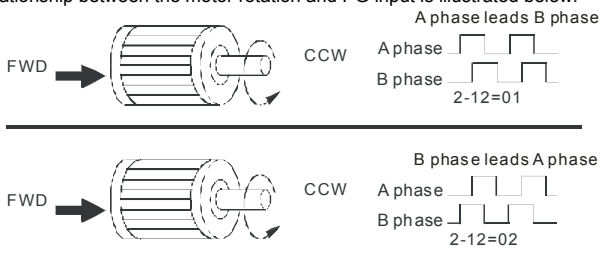

<b>2 – 13</b>	Electrical Gear A	Unit: 1
	Settings 01 to 5000	Factory Setting: 100
<b>2 – 14</b>	Electrical Gear B	Unit: 1
	Settings 01 to 5000	Factory Setting: 100

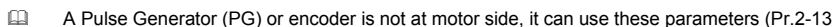
-  A Pulse Generator (PG) or encoder is not at motor side, it can use these parameters (Pr.2-13 and Pr.2-14) to set the deceleration ratio of motor and encoder (electrical gear A/electrical gear B). The actual output frequency will be based on the following equation:  
 Output frequency = PG frequency x electrical gear A (Pr.2-13) / electrical gear B (Pr.2-14).

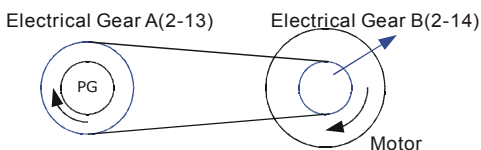

<b>2 – 15</b>	ASR (Auto Speed Regulation for door open) control (with PG only) (P)	Unit: 0.1
	Settings 0.0 to 10.0	Factory Setting: 0.5

-  This parameter specifies Proportional control and associated gain (P), and is used for speed control with PG (encoder) feedback.

### NOTE

The parameter can be set during operation for easy tuning.

<b>2 – 16</b>	ASR (Auto Speed Regulation for door open) control (with PG only) (I)	Unit: 0.01
	Settings 0.00 to 100.00 sec	Factory Setting: 1.00
	0.00 disable	

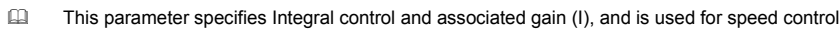
-  This parameter specifies Integral control and associated gain (I), and is used for speed control with PG (encoder) feedback.

### NOTE

The parameter can be set during operation for easy tuning.



<b>2 – 17</b>	PG Slip Compensation Limit	Unit: 0.01
	Settings 0.00 to 60.00Hz	Factory Setting: 20.00

 This parameter limits the amount of correction by the PI control on the output frequency when controlling speed via PG (encoder) feedback. It can limit the maximum output frequency.

<b>2 – 18</b>	↗ Deviation Range of PG Feedback Signal Error	Unit: 0.01
	Settings 0.01~100 Hz	Factory Setting: 3.00

 The base is Pr.1-00. When in PG feedback control, if | Source of PG reference target – feedback | > Pr.2-18 and exceeds Pr.2-19 detection time, the AC drive will operate according to Pr.2-20.

<b>2 – 19</b>	PG Feedback Signal Detection Time	Unit: 0.1
	Settings 0.0 to 100.0 sec	Factory Setting: 1.0

 This parameter defines the time during which the PG feedback must be abnormal before a warning (see Pr.2-20) is given. It also can be modified according to the system feedback signal time.

 If this parameter is set to 0.0, the system would not detect any abnormality signal.

<b>2 – 20</b>	↗ Treatment of the Erroneous PG Feedback Signals	Factory Setting: 00
	Settings 00 Warning and keep operating	
	01 Fault and RAMP to stop	
	02 Warning and low speed operation	

 AC motor drive action when the PG feedback signal is abnormal acc. To Pr.2-18.

<b>2 – 21</b>	Sample time for refreshing the content of 210DH and 210EH	Unit: 0.01
	Settings 0.01~1.00 sec	Factory Setting: 0.10

 When the signal source of feedback control is PG (encoder) and it needs to read the pulse numbers from communication, this parameter can be used to set the refresh time of two communication addresses (210D and 210E).

## Speed Control Diagram

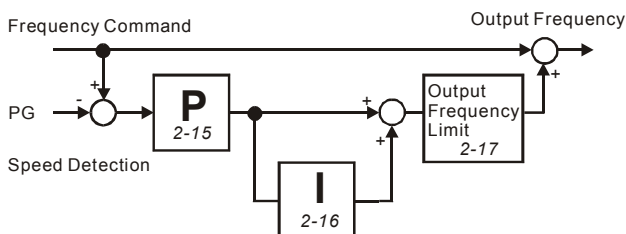
**2 – 22** Door Width Auto-tuning Frequency

Unit: 0.01

Settings 0.10~400.0 Hz

Factory Setting: 4.00

This parameter is the frequency of motor when using door width auto-tuning function.

**2 – 23** Door Width Auto-tuning Function

Factory Setting: 00



Settings	00	Disable
	01	Enable

The door width will be difference due to its application. For example, the door of the freight elevator is much wider than passenger elevator. Therefore, it needs to have door width auto-tuning function to measure the correct door width for the correct position and door open/close.

The procedure for the door width auto-tuning function

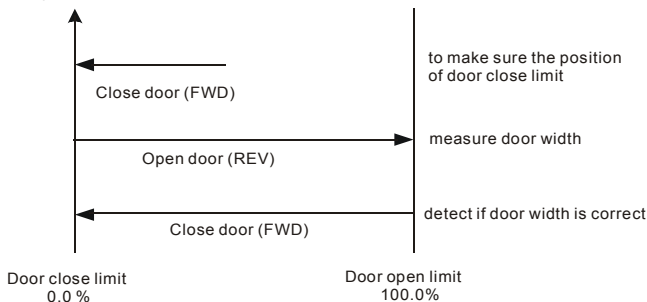
First, operate to the door from the door close complete position to the door open complete position for measuring the door width. Then, close the door to the complete position for confirming the door width.



-  After running this function, the value of door width will auto fill in Pr.2-24 and Pr.2-25.
-  When executing auto-tuning, the start/stop DC brake function is disabled.
-  The fault code *RUE* will be displayed when the auto-tuning time is more than 180 seconds and it means fail to auto-tuning.

<b>2 – 24</b>	Door Width Pulses (Unit: 1)	Unit: 1
	Settings 01~9999	Factory Setting: 7500

<b>2 – 25</b>	Door Width Pulses (Unit: 10000)	Unit: 1
	Settings 00~99	Factory Setting: 00

-  After setting Pr. 2-23 to 01 and finishing execution, door width pulses will auto fill into Pr.2-24 and Pr.2-25.

<b>2 – 26</b>	Reserved
---------------	----------

<b>2 – 27</b>	Reserved
---------------	----------

<b>2 – 28</b>	 ASR (Auto Speed Regulation for door close) control (with PG only) (P)	Unit: 0.1
	Settings 0.0 to 10.0	Factory Setting: 0.5

-  This parameter specifies Proportional control and associated gain (P), and is used for speed control with PG (encoder) feedback.

### NOTE

The parameter can be set during operation for easy tuning.

<b>2 – 29</b>	 ASR (Auto Speed Regulation for door close) control (with PG only) (I)	Unit: 0.01
	Settings 0.00 to 100.00	Factory Setting: 1.00
	0.00 disable	

-  This parameter specifies Integral control and associated gain (I), and is used for speed control with PG (encoder) feedback.

### NOTE

The parameter can be set during operation for easy tuning.

## Group 3: Door Open Parameters

<b>3-00</b>	↗ Door Open Coupling speed	Unit: 0.01
	Settings 0.00~400.0Hz	Factory Setting: 8.40
<b>3-01</b>	↗ Door Open High Speed Start	Unit: 1
	Settings 00~65535 (pulse number)	Factory Setting: 300
<b>3-02</b>	↗ Door Open High Speed 1	Unit: 0.01
	Settings 0.00~400.0Hz	Factory Setting: 42.00
<b>3-03</b>	↗ Door Open Final Speed Start	Unit: 0.01
	Settings 0.0~100.0% (0.0%: close complete, 100.0%: open complete)	Factory Setting: 95.0
<b>3-04</b>	↗ Door Open Final Speed	Unit: 0.01
	Settings 0.00~400.0Hz	Factory Setting: 5.00
<b>3-05</b>	↗ Door Open Holding Speed Start	Unit: 0.1
	Settings 0.0~100.0% (0.0%: close complete, 100.0%: open complete)	Factory Setting: 99.0
<b>3-06</b>	↗ Door Open Holding Speed	Unit: 0.01
	Settings 0.00~400.0Hz	Factory Setting: 2.00
<b>3-07</b>	↗ Door Open Acceleration Time 1	Unit: 0.1
	Settings 0.1~3600sec	Factory Setting: 2.0
<b>3-08</b>	↗ Door Open Deceleration Time 1	Unit: 0.1
	Settings 0.1~3600sec	Factory Setting: 2.0
<b>3-09</b>	↗ Door Open High Speed 2	Unit: 0.01
	Settings 0.00~400.0Hz	Factory Setting: 30.00
<b>3-10</b>	↗ Door Open Acceleration Time 2	Unit: 0.1
	Settings 0.1~3600sec	Factory Setting: 10.0
<b>3-11</b>	↗ Door Open Deceleration Time 2	Unit: 0.1
	Settings 0.1~3600sec	Factory Setting: 10.0

 The unit of Pr.3-01 is pulse number. It should be less than Pr.3-03 after converting to %.

 Please adjust by following diagram to meet your application.

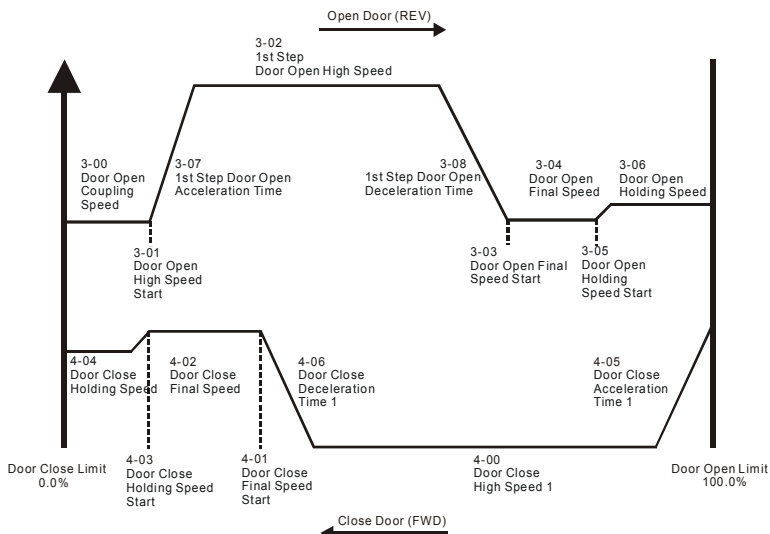

**3 – 12** ✓ Door Open Holding Torque (100.0% is drive rated current) Unit: 0.1

Settings 0.0~100.0% Factory Setting: 30.0

**3 – 13** ✓ Response Time of Door Open Holding Torque Unit: 0.01

Settings 0.01~10.00sec Factory Setting: 0.20

When the door is in the open complete position, it needs holding torque to make the door be in that position. To prevent motor overload, the holding torque should be limited (Pr.3-12).

**3 – 14** Door Open Time-out Setting Unit: 0.1

Settings 0.0~180.0sec (0.0: disable) Factory Setting: 0.0

When the door open exceeds this setting, the fault code “ eca” will occur and the motor will decelerate to stop. It needs to have door open/close command again after resetting the AC motor drive.

Any type of voltmeter can be used. If the meter reads full scale at a voltage less than 10 volts, the parameter 03-06 should be set using the following formula:

$$\text{Pr. 03-06} = ((\text{meter full scale voltage})/10) \times 100\%$$

For Example: When using the meter with full scale of 5 volts, adjust Pr.03-06 to 50%. If Pr.03-05 is set to 0, then 5VDC will correspond to Maximum Output Frequency.



<b>3 – 15</b>	↗The Current Level 1 to Decrease to Pr.3-12 after Door Open Completed		Unit: 0.1
	Settings	0.0~150.0%	Factory Setting: 0.0
<b>3 – 16</b>	↗The Current Level 2 to Decrease to Pr.3-12 after Door Open Completed		Unit: 0.1
	Settings	0.0~150.0%	Factory Setting: 0.0

 The door machine will be in holding torque mode when the motor stall exceeds this setting after door open complete is reached.

<b>3 – 17</b>	↗Holding Time for Terminal REV		Unit: 0.1
	Settings	0.0 to 999.9 sec	Factory Setting: 0.0

 This parameter is used to remove the REV terminal signal (door open signal) when door open complete. The AC Motor Drive will still in RUN mode before the setting time. After reaching this setting, the AC Motor Drive will stop running. This function will be invalid before door open complete.

 The FWD command (door close command) can be operated before this setting to close the door.

 When Pr.3-17 is set to 999.9 (REV terminal is always holding), it needs to stop AC Motor Drive by  key on the keypad.

<b>3 – 18</b>	S Curve Acceleration Time for Door Open		Unit: 0.1
	Settings	0.0 to 10.0 sec	Factory Setting: 0.0

 This parameter is used to ensure smooth acceleration and deceleration via S-curve.

The S-curve is disabled when set to 0.0 and enabled when set to 0.1 to 10.0/0.01 to 10.00.

Setting 0.1/0.01 gives the quickest and setting 10.0/10.00 the longest and smoothest S-curve.

The AC motor drive will not follow the Accel Times in Pr.3-07/Pr.3-10

 The diagram below shows that the original setting of the Accel/Decel Time is only for reference when the S-curve is enabled. The actual Accel Time depends on the selected S-curve (0.1 to 10.0).

The total Accel. Time=Pr.3-07 + (2\*Pr.3-18) or Pr.3-10 + (2\*Pr.3-18)

For example: if Pr.4-05=3, Pr.4-23=2, then the total door close acceleration time =3+(2\*)=7 sec (To calculate with F=60Hz, if F=30, the total acceleration time will be reduced by half)

If Pr.3-18 is larger than Pr.3-07, the total acceleration time= $2*\sqrt{3-07*3-18}$

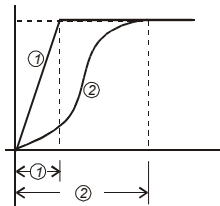

- ① Disable S curve
- ② Enable S curve

**Acceleration Characteristics**

Timing diagram for multi-step door open

1. Multi-step mode 1 (Pr.0-09=2)

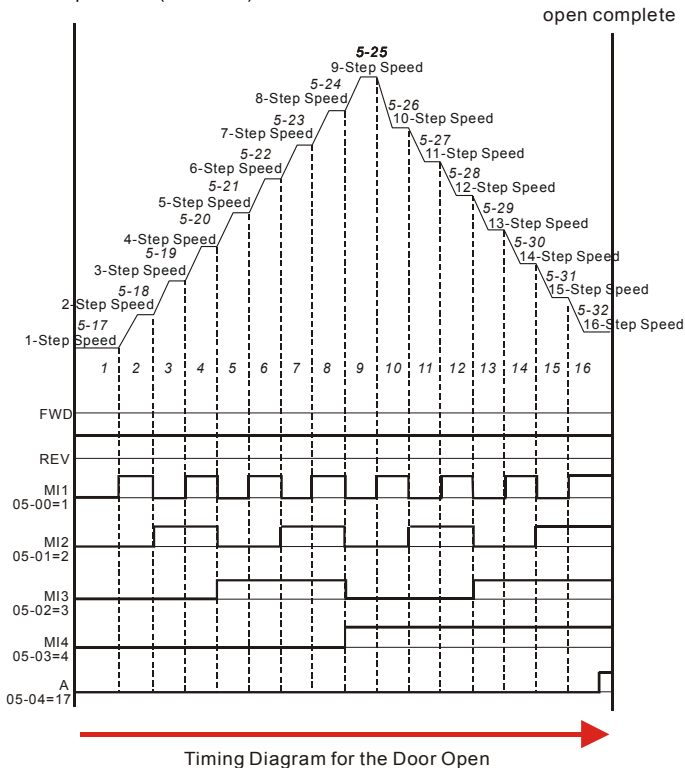

2. Multi-step mode 2 (Pr.0-09=3)

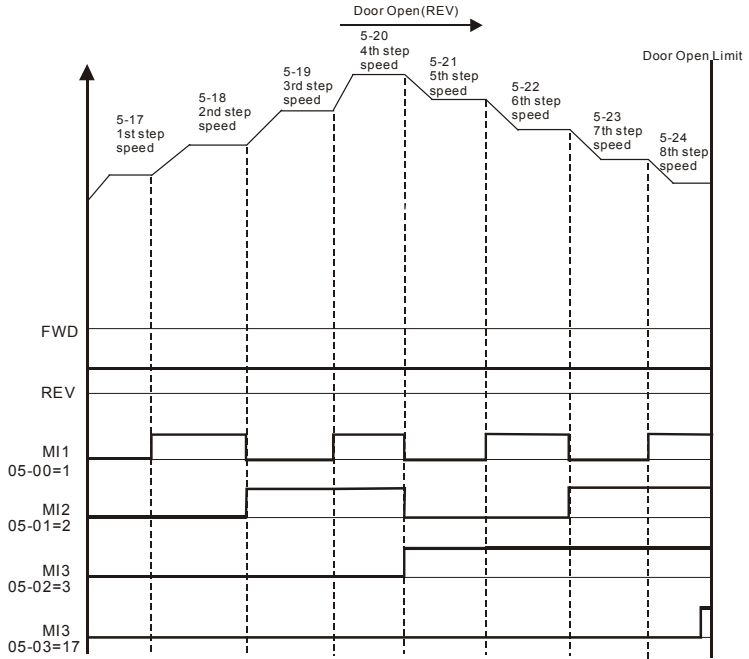

Timing Diagram for the Door Open



3. Multi-step mode 3 (Pr.0-09=4)

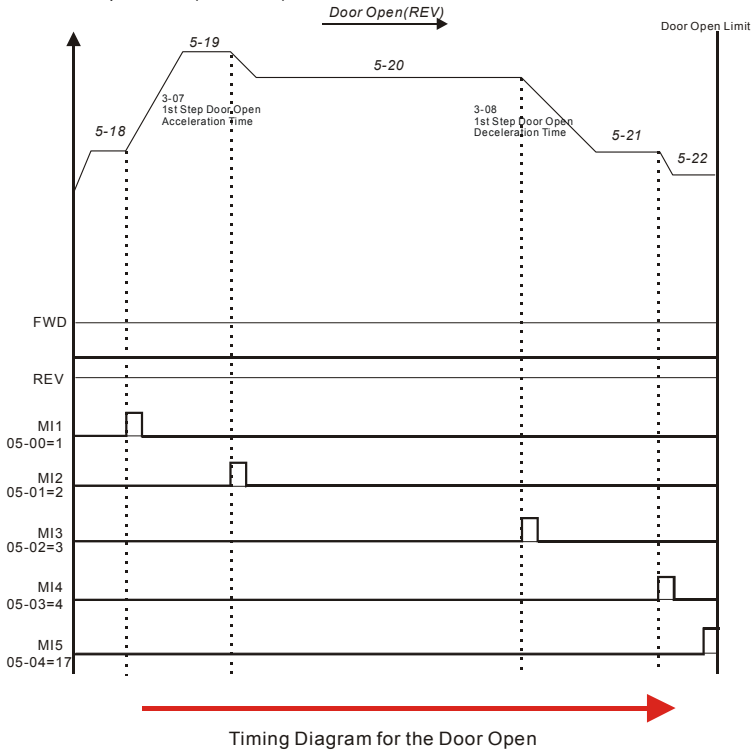

4. Multi-step mode 4 (Pr.0-09=5)

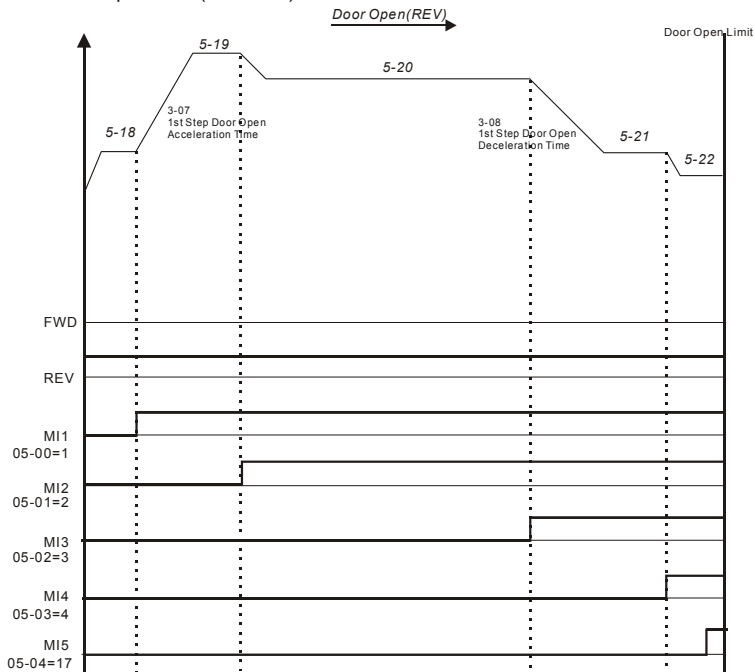

→  
 Timing Diagram for the Door Open

**Group 4: Door Close Parameters**

<b>4 – 00</b>	✓ Door Close High Speed 1	Unit: 0.01
	Settings 0.00~400.0Hz	Factory Setting: 30.00
<b>4 – 01</b>	✓ Door Close Final Speed Start	Unit: 0.1
	Settings 0.0~100.0% (0.0%: close complete, 100.0%: open complete)	Factory Setting: 4.0
<b>4 – 02</b>	✓ Door Close Final Speed	Unit: 0.01
	Settings 0.00~400.0Hz	Factory Setting: 5.00
<b>4 – 03</b>	✓ Door Close Holding Speed Start	Unit: 0.1
	Settings 0.0~100.0% (0.0%: close complete, 100.0%: open complete)	Factory Setting: 1.0
<b>4 – 04</b>	✓ Door Close Holding Speed	Unit: 0.01
	Settings 0.00~400.0Hz	Factory Setting: 2.00
<b>4 – 05</b>	✓ Door Close Acceleration Time 1	Unit: 0.1
	Settings 0.1~3600sec	Factory Setting: 2.0
<b>4 – 06</b>	✓ Door Close Deceleration Time 1	Unit: 0.1
	Settings 0.1~3600sec	Factory Setting: 2.0
<b>4 – 07</b>	✓ Door Close High Speed 2	Unit: 0.01
	Settings 0.00~400.0Hz	Factory Setting: 20.00
<b>4 – 08</b>	✓ Door Close Acceleration Time 2	Unit: 0.1
	Settings 0.1~3600sec	Factory Setting: 10.0
<b>4 – 09</b>	✓ Door Close Deceleration Time 2	Unit: 0.1
	Settings 0.1~3600sec	Factory Setting: 10.0

 Pr.4-00 to Pr.4-09 can be used only when Pr.00-09 is set to 00 Distance control mode 1 or 01 Distance control mode 2.

 Please adjust by following diagram to meet your application.

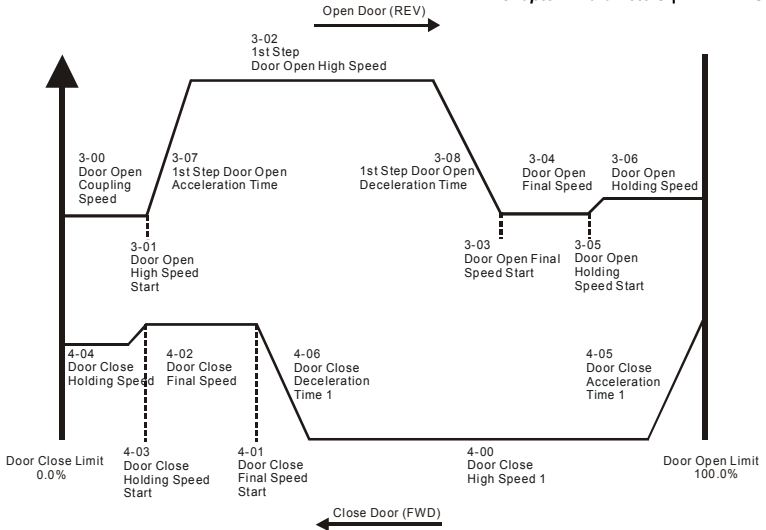

<b>4 - 10</b>	↗ Re-open Current Level 1	Unit: 0.1
	Settings 0.0~150.0% (100.0% is drive rated current)	Factory Setting: 100.0
<b>4 - 11</b>	Re-open Current Level 1 for Acceleration Area	Unit: 1
	Settings 100~200% (100% is Pr.4-10 setting)	Factory Setting: 150
<b>4 - 24</b>	↗ Re-open Current Level 1 for Low Speed Area	Unit: 1
	Settings 100~200% (100% is Pr.4-10 setting)	Factory Setting: 150
<b>4 - 12</b>	↗ Re-open Current Level 2	Unit: 0.1
	Settings 0.0~150.0% (100.0% is drive rated current)	Factory Setting: 100.0
<b>4 - 13</b>	Re-open Current Level 2 for Acceleration Area	Unit: 1
	Settings 100~200% (100% is Pr.4-12 setting)	Factory Setting: 150
<b>4 - 25</b>	↗ Re-open Current Level 2 for Low Speed Area	Unit: 1
	Settings 100~200% (100% is Pr.4-10 setting)	Factory Setting: 150
<b>4 - 14</b>	↗ Re-open Deceleration Time	Unit: 0.1
	Settings 0.1~3600sec	Factory Setting: 0.2
<b>4 - 17</b>	↗ Re-open for Low Speed Area	Unit: 0.1
	Settings 1.0 to 99.0% (100% is the door width, low speed area is 0%~Pr. 4-17)	Factory Setting: 2.0

Settings 8.0 to 97.0% (100% is the door width, acceleration area is Pr. 4-18~100%)

Factory Setting: 70.0

- During the door close, it will re-close from the open complete position to the close complete position when there is an obstacle (the stall current exceeds Pr.4-10/4-11/4-12/4-13).
- Pr.4-14 is used to set the time for decelerating to 0Hz when there is an obstacle. It is recommended to set a minimum value that less than the current limit to re-open in the shortest time for people's safety.
- It needs large current when accelerating for start open/close door. Therefore, it needs to have larger re-open current in the acceleration area. Please refer to following figure for setting re-open current and acceleration area.

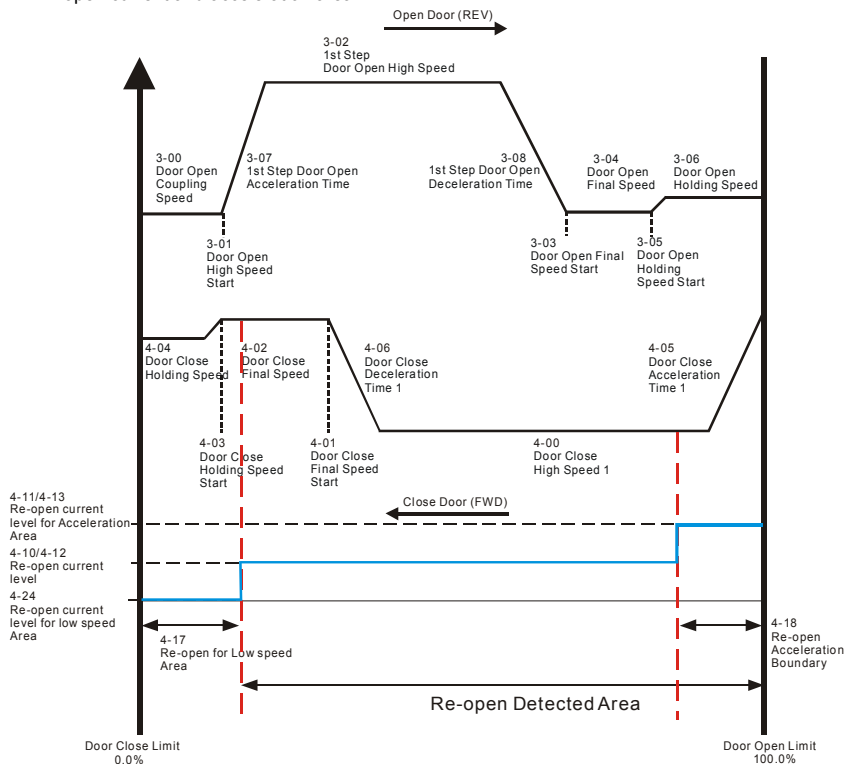

<b>4 – 15</b>	↗Door Close Holding Torque	Unit: 0.1
	Settings 0.0~100.0% (100.0% is drive rated current)	Factory Setting: 30.0

<b>4 – 16</b>	↗Response Time of Door Close Holding Torque	Unit: 0.01
	Settings 0.01~10.00sec	Factory Setting: 0.20

 When the door is in the close complete position, it needs holding torque to make the door be in that position. To prevent motor overload, the holding torque should be limited (Pr.4-15).

<b>4 – 19</b>	Door Close Time-out Setting	Unit: 0.1
	Settings 0.0~180.0sec (0.0: disable)	Factory Setting: 0.0

 When the door close time exceeds this setting, the door will re-open automatically.

<b>4 – 20</b>	↗The Current Level 1 to Decrease to Pr.4-15 after Door Close	Unit: 0.1
	Settings 0.0~150.0%	Factory Setting: 0.0



<b>4 – 21</b>	↗The Current Level 2 to Decrease to Pr.4-15 after Door Close	Unit: 0.1
	Settings 0.0~150.0%	Factory Setting: 0.0

 After the door is in the close complete position, the door will be in holding torque state when the motor stall exceeds this setting.

<b>4 – 22</b>	↗Holding Time for Terminal FWD	Unit: 0.1
	Settings 0.0 to 999.9 sec	Factory Setting: 0.0

 This parameter is used to remove the FWD terminal signal (door close signal) when door close complete. The AC Motor Drive will still in RUN mode before the setting time. After reaching this setting, the AC Motor Drive will stop running. This function will be invalid before door close complete.

 The REV command (door open command) can be operated before this setting to open the door.

 When Pr.4-22 is set to 999.9 (FWD terminal is always holding), it needs to stop AC Motor Drive by  key on the keypad.

<b>4 – 23</b>	S Curve Acceleration Time for Door Close	Unit: 0.1
	Settings 0.0 to 10.0 sec	Factory Setting: 0.0

 Its function is the same as Pr.3-18.

The total acceleration time =4-05+(2\* 4-23) or 4-08+(2\* 4-23)

For example: if Pr.4-05=3, Pr.4-23=2, then the total door close acceleration time = $3+(2*2)=7$  sec (To calculate with F=60Hz, if F=30, the total acceleration time will be reduced by half)  
 If Pr.4-23 is larger than Pr.4-05, the total acceleration time= $2*\sqrt{4-05*4-23}$

 Timing diagram for multi-step door close

1. Multi-step mode 1 (Pr.0-09=2)

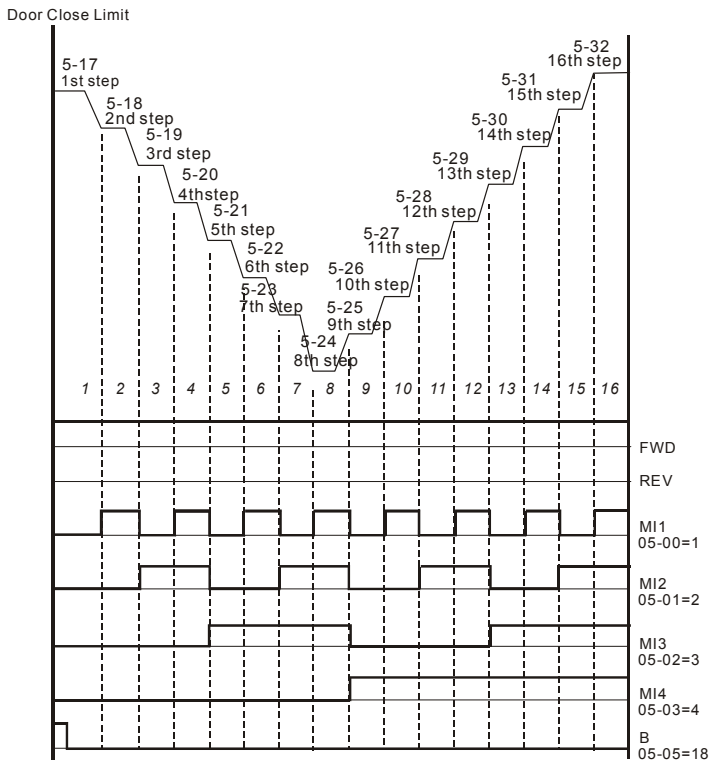

Timing Diagram for the Door Close

## 2. Multi-step mode 2 (Pr.0-09=3)

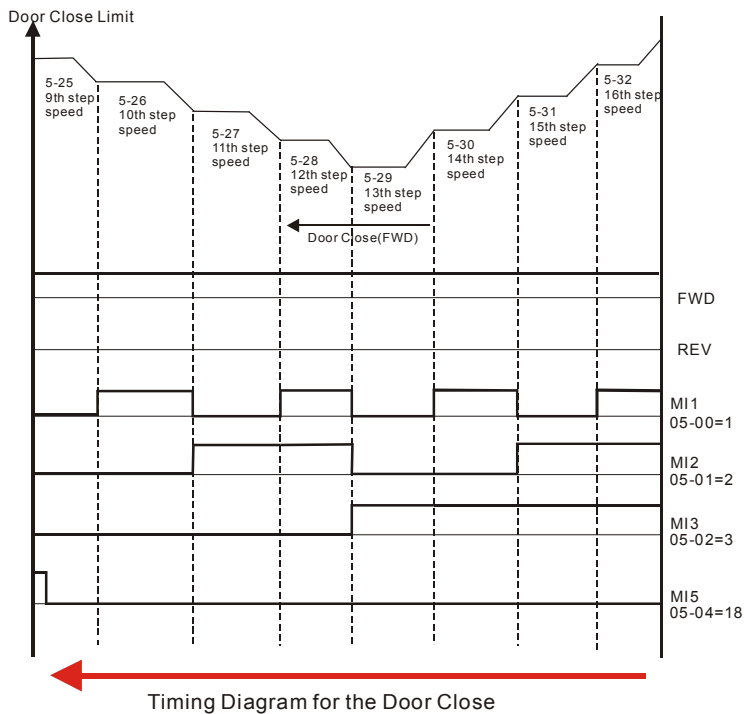



3. Multi-step mode 3 (Pr.0-09=4)

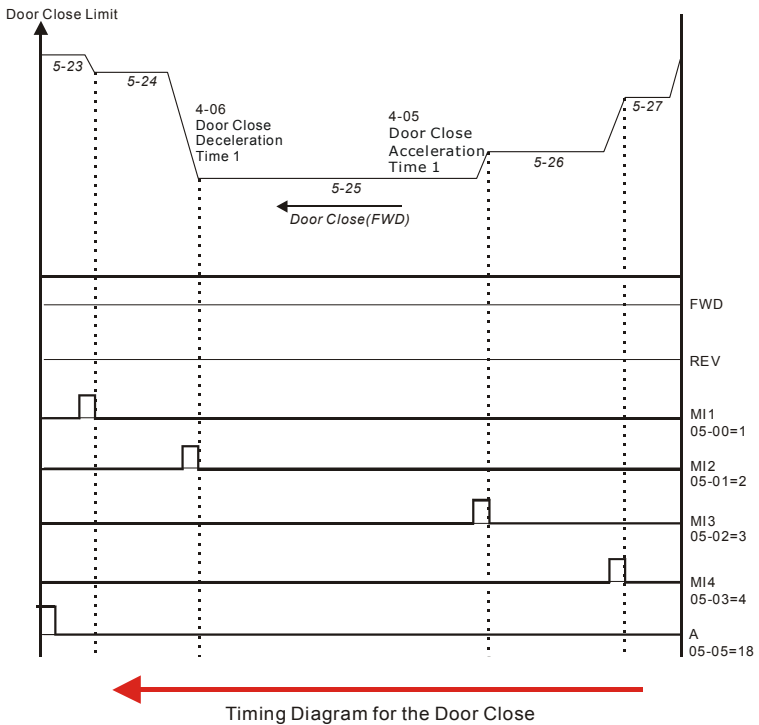

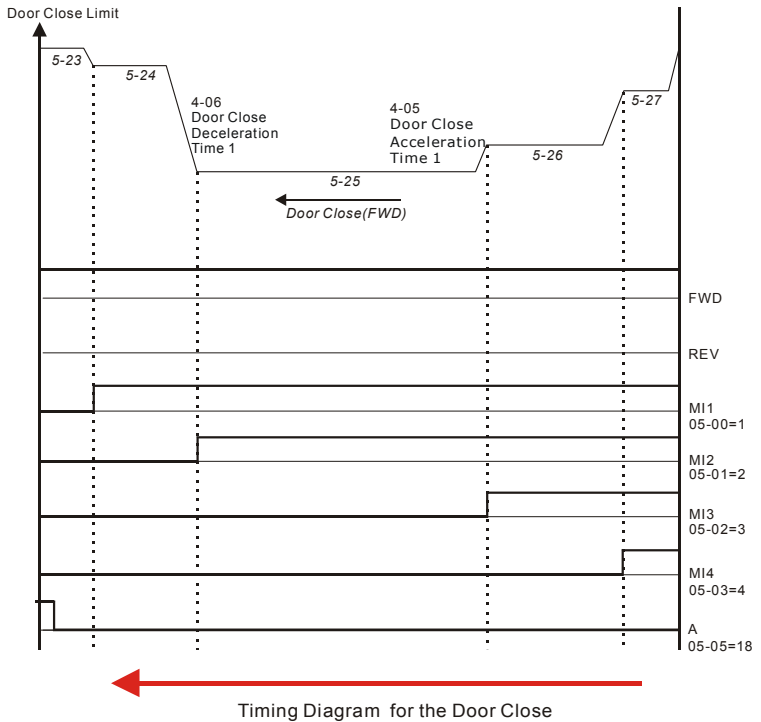

4. Multi-step mode 4 (Pr.0-09=5)



## Group 5: Multi-step speeds and PLC (Process Logic Control) parameters

5 – 00	Multi-function Input Terminal (MI1)	Factory Setting: 00
5 – 01	Multi-function Input Terminal (MI2)	Factory Setting: 00
5 – 02	Multi-function Input Terminal (MI3)	Factory Setting: 00
5 – 03	Multi-function Input Terminal (MI4)	Factory Setting: 00
5 – 04	Multi-function Input Terminal (MI5)	Factory Setting: 00
5 – 05	Multi-function Input Terminal (A)	Factory Setting: 00
5 – 06	Multi-function Input Terminal (B)	Factory Setting: 00
5 – 07	Multi-function Input Terminal (COM1)	Factory Setting: 00
5 – 08	Multi-function Input Terminal (COM2)	Factory Setting: 00
5 – 09	Multi-function Input Terminal (COM3)	Factory Setting: 00
5 – 10	Multi-function Input Terminal (COM4)	Factory Setting: 00

-  These parameters can be used by the application.
-  Before using the functions of Pr.5-05 and Pr.5-06, Pr.2-12 should be set to 00.
-  It needs to set COM1 to COM4 to ON/OFF by communication and the corresponding address for COM1 to COM4 is **2006H** as shown in the following.

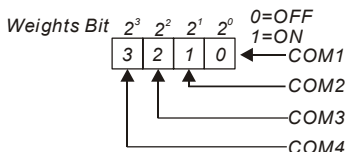

Settings	Function	Description
00	No Function	Any unused terminals should be programmed to 0 to insure they have no effect on operation.
01	Multi-Step Speed Command 1	When door control mode (Pr.0-09) is set to 02 or 03 (Multi-step control mode 1 and Multi-step control mode 2), these four inputs can be used for 17 step speed frequencies (including Master Frequency and Jog Frequency).  When door control mode (Pr.0-09) is set to 04 (Multi-step control mode 3), it can also used for speed change.
02	Multi-Step Speed Command 2	
03	Multi-Step Speed Command 3	
04	Multi-Step Speed Command 4	
05	1 <sup>st</sup> /2 <sup>nd</sup> Accel/ decel Time Selection	Used to select 1 <sup>st</sup> /2 <sup>nd</sup> Accel/ decel time. ON: 1 <sup>st</sup> Accel/ decel Time OFF: 2 <sup>nd</sup> Accel/ decel Time
06	Low Speed Operation	Before using this function, please make sure that AC motor drive is stop. At this moment, key "STOP" on the digital keypad is still valid. When this contact is OFF, motor will stop by deceleration time of low speed operation. Refer to Pr.1-07 to Pr.1-09 for details.
07	FWD/REV Command for Low Speed Operation	ON: REV OFF: FWD  This command will be effective only when external terminal for low speed operation is active.
08	Demo Mode	When this setting is enabled, the output frequency of AC motor drive will run by open/close curve repeatedly till this setting is disabled. It will get the best open/close curve by this action.
09	Forced Stop (N.O.)	These two parameters have the same function as the "STOP" command with stop method acc. To Pr.0-13. No error message is displayed. When parameter value 09 or 10 is enabled, a new RUN command is needed.
10	Forced Stop (N.C.)	
11	Emergency Stop (N.O.)	When setting to 11 or 12, the Multi-Function Input Terminal can be used to stop the AC motor drive in case of malfunction in the application. It will display "EF". Please "RESET" after the fault has been cleared. Refer to Pr.0-13 for Stop Method.
12	Emergency Stop (N.C.)	
13	Operation Command Selection (Keypad/external terminals)	ON: Operation command via Ext. Terminals OFF: Operation command via Keypad Pr.0-12 is disabled if this parameter value 13 is set.
14	Parameter Lock Enable	When this setting is enabled, all parameters will be locked and write parameters is disabled.

Settings	Function	Description
15	External Reset (N.O.)	The External Reset has the same function as the Reset key on the digital keypad. After faults such as O.H., O.C. and O.V. are cleared, this input can be used to reset the drive.
16	External Reset (N.C.)	
17	The signal when it is in open completed position	When Pr.0-15 is set to 01 or 03, drive will open the door to the completed position by this signal.
18	The signal when it is in close completed position	When Pr.0-15 is set to 02 or 03, drive will close the door to the completed position by this signal.
19	Open Allowance Signal	When this setting is enabled, it allows to open the door. It also can be used for the signal of door zone.
20	Force Door open Signal	When this setting is enabled, it will force opening the door. Only when this setting is disabled, the door can be closed. This signal will be invalid when the door is in the close complete position. When value 19 is set, this setting can be ON after the value 19 is ON.
21	Home Return	When this setting is enabled, the drive will execute position function.
22	The curve selection for 1 <sup>st</sup> /2 <sup>nd</sup> step door open/close	When this setting is ON, it will run the curve of 2 <sup>nd</sup> step door open/close.
23	The signal when it is in open completed position, including RUN signal	When Pr.0-15 is set to 01 or 03, it will open the door to the completed position by this signal. This signal also can run the drive when there is no RUN command and operation direction is REV. It can be used for holding torque when the open command is disabled after door is in the open complete position.
24	The signal when it is in close completed position, including RUN signal	When Pr.0-15 is set to 02 or 03, it will close the door to the completed position by this signal. This signal also can run the drive when there is no RUN command and operation direction is FWD. It can be used for holding torque when the close command is disabled after door is in the close complete position.

 N.O.= Normally Open. N.C.= Normally Closed.

#### 5 – 11 Line Start Lockout (only for external terminals)

Factory Setting: 00

Settings	00	Disable
	01	Enable

 When the operation command source is from external terminal and operation command is ON (FWD/REV-DCM=close), the AC motor drive will operate according to Pr.5-11 after power is applied. **<For terminals FWD and REV only>**

1. When Pr.5-11 is set to 00, AC motor drive will run immediately.
2. When Pr.5-11 is set to 01, AC motor drive will remain stopped until operation command is received after previous operation command is cancelled.

 **NOTE**

The Line Start Lockout feature does not guarantee that the motor will never start under this condition. It is possible the motor may be set in motion by a malfunctioning switch.

**5 – 12** 2-wire/3-wire Operation Control Modes Factory Setting: 00

Settings	00	2-wire: FWD/STOP, REV/STOP
	01	2-wire: FWD/REV, RUN/STOP
	02	3-wire operation control

 There are two different types of control modes:

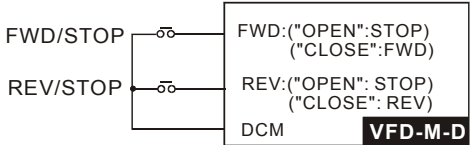
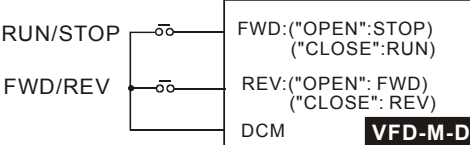
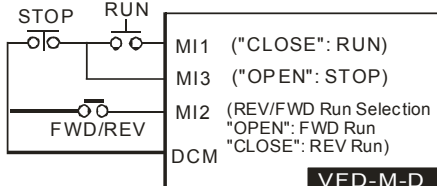
5 – 12	External Terminal
00 <u>2-wire</u> FWD /STOP REV / STOP	
01 <u>2-wire</u> FWD /REV RUN / STOP	
02 <u>3-wire</u>	

<b>5 - 13</b>	Digital Terminal Input Debouncing Time	Unit: 2.5
	Settings 1 to 20	Factory Setting: 1

 This parameter is to delay the signals on digital input terminals. 1 unit is 2.5 msec, 2 units are 5 msec, etc. The delay time is to debounce noisy signals that could cause the digital terminals to malfunction.

<b>5 - 14</b>	↗ Waiting Time for Next Demo	Unit: 0.1
	Settings 0.1 to 999.9sec	Factory Setting: 2.0

 When executing demo mode, it will go to the next demo after this setting.

<b>5 - 15</b>	The Record for Demo Times	Unit: 1
	Settings 00 to 9999	Factory Setting: 00

 When executing demo mode, it will count once after finishing one action of door open and close.

<b>5 - 16</b>	↗ Clear Demo Times	Factory Setting: 00
	Settings 00 Disable	
	01 Enable	

 It will clear demo times to 0 when this parameter is set to 01.



<b>5 - 17</b>	↗ 1st Step Speed Frequency	Unit: 0.01
<b>5 - 18</b>	↗ 2nd Step Speed Frequency	Unit: 0.01
<b>5 - 19</b>	↗ 3rd Step Speed Frequency	Unit: 0.01
<b>5 - 20</b>	↗ 4th Step Speed Frequency	Unit: 0.01
<b>5 - 21</b>	↗ 5th Step Speed Frequency	Unit: 0.01
<b>5 - 22</b>	↗ 6th Step Speed Frequency	Unit: 0.01
<b>5 - 23</b>	↗ 7th Step Speed Frequency	Unit: 0.01
<b>5 - 24</b>	↗ 8th Step Speed Frequency	Unit: 0.01
<b>5 - 25</b>	↗ 9th Step Speed Frequency	Unit: 0.01
<b>5 - 26</b>	↗ 10th Step Speed Frequency	Unit: 0.01
<b>5 - 27</b>	↗ 11th Step Speed Frequency	Unit: 0.01
<b>5 - 28</b>	↗ 12th Step Speed Frequency	Unit: 0.01
<b>5 - 29</b>	↗ 13th Step Speed Frequency	Unit: 0.01
<b>5 - 30</b>	↗ 14th Step Speed Frequency	Unit: 0.01

5 - 31	↗ 15th Step Speed Frequency	Unit: 0.01
--------	-----------------------------	------------

5 - 32	↗ 16th Step Speed Frequency	Unit: 0.01
--------	-----------------------------	------------

Factory Setting: 0.00



Settings 0.00 to 400.0 Hz

-  The Multi-Function Input Terminals (refer to Pr.5-00 to 5-10) are used to select one of the AC motor drive Multi-step speeds. The speeds (frequencies) are determined by Pr.5-17 to 5-32 as shown above.
-  When using with door control system (Pr.0-09=02/03/04), it will run the door open/close curve by the output of position sensor to change speed.

5 - 33	Multi-function Input Terminal Status (N.O/N.C)	Unit: 1
--------	--	---------

Settings 0 to 8191

Factory Setting: 0

-  It is used to set multi-function input terminals FWD, REV and output status of Pr.5-00 to Pr.5-10 to be normal open (N.O.) or normal closed (N.C.).
-  Setting methods:

It needs to convert 13-bit binary value to decimal value before entering this parameter.

For example: Suppose that the initial status of REV, MI2, MI4, MI5, COM1, COM2 and COM4 is N.C. The initial status of FWD, MI1, MI3, A, B and COM3 is N.O. At this moment, you need to input 5738 into Pr. 5-33 as shown in the following.

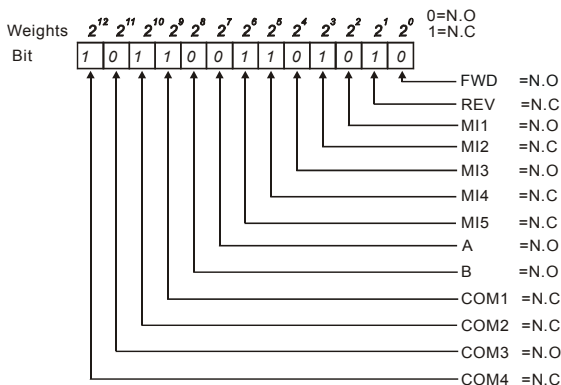

The setting value

$$\begin{aligned}
 &= \text{bit}14 \times 2^{12} + \text{bit}13 \times 2^{11} + \dots + \text{bit}2 \times 2^2 + \text{bit}1 \times 2^1 + \text{bit}0 \times 2^0 \\
 &= 1 \times 2^{12} + 1 \times 2^{10} + 1 \times 2^7 + 1 \times 2^6 + 1 \times 2^5 + 1 \times 2^4 + 1 \times 2^3 + 1 \times 2^1 \\
 &= 4096 + 1024 + 512 + 64 + 32 + 8 + 2 = 5738
 \end{aligned}$$

Setting 5-33

NOTE:

$2^{14}=16384$	$2^{13}=8192$	$2^{12}=4096$	$2^{11}=2048$	$2^{10}=1024$
$2^9=512$	$2^8=256$	$2^7=128$	$2^6=64$	$2^5=32$
$2^4=16$	$2^3=8$	$2^2=4$	$2^1=2$	$2^0=1$



Settings	00	Bit0=0: Disable to detect the incorrect open/close limit function
	01	Bit0=1: Enable to detect the incorrect open/close limit function
	02	Bit1=0: Enable to re-open when door close error
	03	Bit1=1: Disable to re-open when door close error
	04	Bit2=0: Enable S-Curve when re-open
	05	Bit2=1: Disable S-Curve when re-open
	06	Bit3=0: Disable to reset door width to 100.0% after door open completed
	07	Bit3=1: Enable to reset door width to 100.0% after door open completed

 It uses bit setting. Following figure shows the relation between the bit and the keypad.



 The keypad LC-M2E will display PSEr (position signal error) when following item occurs.

1. When Pr.5-34 is set to Bit0=1 and Pr.0-09 is set to 00 or 01: incorrect door open/close limit.
2. When Pr.5-34 is set to Bit0=1 and Pr.00-09 is set to 04: The operation steps for the door open/close aren't by the setting.

 When Pr.0-09 is set to 00/01, the detection method for the incorrect door open/close limit is shown as follows.

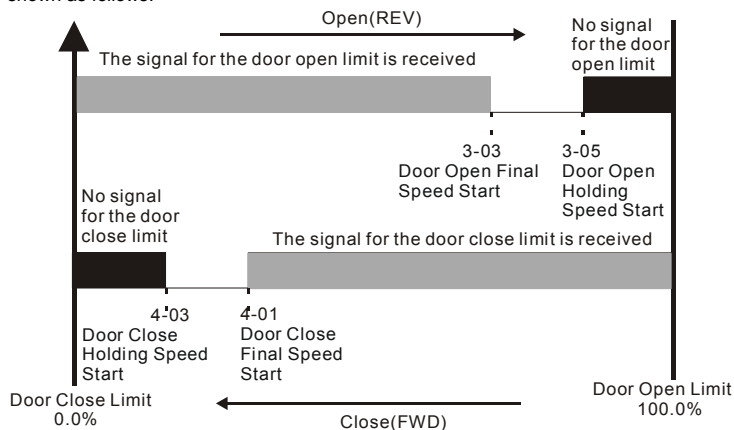

- Incorrect door open limit:
  - a. The signal for the door close limit is received before Pr.4-01 setting.
  - b. The signal for the door close limit isn't received after Pr.4-03 setting.
- Incorrect door close limit:
  - a. The signal for the door open limit is received before Pr.3-03 setting.
  - b. The signal for the door open limit isn't received after Pr.3-05 setting.
- When bit 1=1 and the torque for the door close exceeds Pr.4-10/4-12, it won't re-open the door. When Pr.6-00 to Pr.6-07 (multi-function outputs) is set to 23, the error signal will also be outputted.
- When bit 2=0, door open signal is given or the door re-opens during door closing, S-Curve set in Pr.3-18 is enabled.
- When bit 2=1, door open signal is given or the door re-opens during door closing, S-Curve set in Pr.3-18 is disabled.

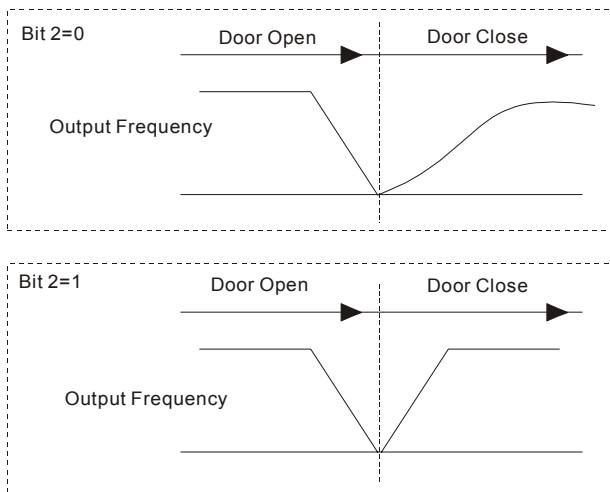

- When bit 3=1 and the drive is in torque holding status after door open completed, the door width is auto-reset to 100.0%.

## Group 6: Digital Output Parameters

6 - 00	Multi-function Output Relay (RA1, RB1, RC1)	Factory Setting: 00
6 - 01	Multi-function Output Relay (RA2, RC2)	Factory Setting: 00
6 - 02	Multi-function Output Terminal MO1	Factory Setting: 00
6 - 03	Multi-function Output Terminal MO2	Factory Setting: 00
6 - 04	Multi-function Output Terminal MO3 (communication)	Factory Setting: 00
6 - 05	Multi-function Output Terminal MO4 (communication)	Factory Setting: 00
6 - 06	Multi-function Output Terminal MO5 (communication)	Factory Setting: 00
6 - 07	Multi-function Output Terminal MO6 (communication)	Factory Setting: 00
Settings	00 to 32	

These parameters can be used for the external terminal output.

It needs to set MO3 to MO6 to ON/OFF by communication and the corresponding address for MO3 to MO6 is **2209H** as shown in the following.

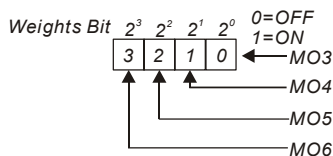

Settings	Function	Description
00	No Function	
01	AC Drive Operational	Active when there is an output from the drive or RUN command is "ON".
02	Master Frequency Attained	Active when the AC motor drive reaches the output frequency setting.
03	Over-Torque Detection	Active as long as over-torque is detected. (Refer to Pr.7-06 ~ Pr.7-07)
04	Low-Voltage Indication	Active when low voltage(Lv) is detected.

Settings	Function	Description
05	Operation Mode Indication	Active when operation command is controlled by external terminal.
06	Fault Indication	Active when faults occur (oc, ov, oH1, oL2, oL, oL1, EF, CF3.3~8, HPF1~4, ocA, ocd, ocn, GFF, PGEr, doEr, CE10).
07	Warning Indication	Active when warnings occur (AUE, SE1, SE2, oL2, PGEr, PSEr, CE0X)
08	Demo indication	Active when demo is executed.
09	A step completed	Active when a step is completed for only 0.5 seconds.
10	A demo completed	Active when a demo is completed for only 0.5 seconds.
11	Forced Stop Indication	Active when the action of forced stop occur.
12	Heat Sink Overheat Warning (OH)	When heatsink overheats, it will signal to prevent OH turn off the drive. When it is higher than 85°C (185°F), it will be ON. Or it will be OFF.
13	AC Motor Drive Ready	Active when the drive is ON and no abnormality detected or AC motor drive is in the state that waits for press "RESET" to clear the fault.
14	Emergency Stop Indication	Active once the drive's emergency stop function is activated.
15	Software Brake Signal	This function is used in conjunction with a VFDB Brake Unit. The output will be activated when the drive needs help braking the load. A smooth deceleration is achieved by using this function.
16	Zero Speed Output Signal	Active unless there is an output frequency present at terminals U/T1, V/T2, and W/T3.
17	Feedback Signal Error	Active when the feedback signal is abnormal. (Refer to Pr.2-18, Pr.2-19)
18	Position Detection 1	Active when the door reaches the position equal to or smaller than Pr.6-09. (both door open and close)
19	Position Detection 2	Active when the door reaches the position equal to or smaller than Pr.6-10. (both door open and close)
20	Position Detection 3	Active when the door reaches the position equal to or smaller than Pr.6-11. (both door open and close)
21	The signal outputs when it is in close completed position	Active when position mode (Pr.0-15) is set to 00 or 04 and the door width is less than Pr.4-03 setting during the door close. Active when position mode (Pr.0-15) is set to 02 or 03 and one of the Pr.5-00 to Pr.5-10 is set to 18.
22	The signal outputs when it is in open completed position	Active when position mode (Pr.0-15) is set to 00 or 04 and the door width is greater than Pr.3-05 during the door open. Active when position mode (Pr.0-15) is set to 01 or 03 and one of the Pr.5-00 to Pr.5-10 is set to 17.
23	Door Close Error	Active when door close error. (no matter it will re-open or not)
24	Reserved	



Settings	Function	Description
25	Position Complete Signal	Active when finishing position after applying power again or PGEr.
26	Reserved	
27	Position Detection 1	Active when the door reaches the position equal to or smaller than Pr.6-09. (door close only)
28	Position Detection 2	Active when the door reaches the position equal to or smaller than Pr.6-10. (door close only)
29	Position Detection 3	Active when the door reaches the position equal to or smaller than Pr.6-11. (door close only)
30	Position Detection 1	Active when the door reaches the position equal to or smaller than Pr.6-09. (door open only)
31	Position Detection 2	Active when the door reaches the position equal to or smaller than Pr.6-10. (door open only)
32	Position Detection 3	Active when the door reaches the position equal to or smaller than Pr.6-11. (door open only)

**6 - 08** Multi-function Output Status

Unit: 1

Settings 00 to 255

Factory Setting: 00

-  This parameter is used to determinate the output status (N.O./N.C.) of Pr.6-00 to Pr.6-07.
-  The equivalent 8-bit number is used to program the output status of Pr.6-00 to Pr.6-07 as shown in the following. This 8-bit number should be converted to decimal number to input to this parameter (Pr.6-08).

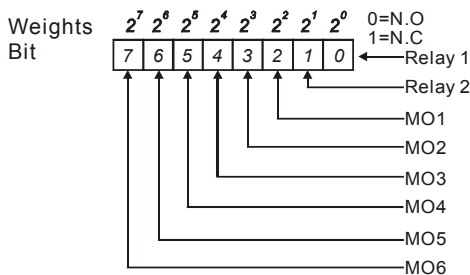

For example:

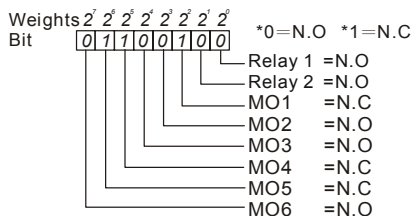

The setting value

$$= \text{bit}7 \times 2^7 + \text{bit}6 \times 2^6 + \text{bit}5 \times 2^5 + \text{bit}4 \times 2^4 + \text{bit}3 \times 2^3 + \text{bit}2 \times 2^2 + \text{bit}1 \times 2^1 + \text{bit}0 \times 2^0$$

$$= 0 \times 2^7 + 1 \times 2^6 + 1 \times 2^5 + 0 \times 2^4 + 0 \times 2^3 + 1 \times 2^2 + 0 \times 2^1 + 0 \times 2^0$$

$$= 0 + 64 + 32 + 0 + 0 + 4 + 0 + 0$$

$$= 100$$

$$\text{setting } 6-08 = 100$$

NOTE:

$$2^0 = 1 \quad 2^3 = 8 \quad 2^6 = 64$$

$$2^1 = 2 \quad 2^4 = 16 \quad 2^7 = 128$$

$$2^2 = 4 \quad 2^5 = 32$$

<b>6 - 09</b>	↗ Position Detection 1	Unit: 0.1
	Settings      0.0 to 100.0%	Factory Setting: 25.0
<b>6 - 10</b>	↗ Position Detection 2	Unit: 0.1
	Settings      0.0 to 100.0%	Factory Setting: 12.5
<b>6 - 11</b>	↗ Position Detection 3	Unit: 0.1
	Settings      0.0 to 100.0%	Factory Setting: 7.5

When Pr.6-00 to Pr.6-07 is set to 18 to 20, it will output a signal once the door is in the position that Pr.6-09 to Pr.6-11 set.

<b>6 - 12</b>	Reserved	
<b>6 - 13</b>	Reserved	
<b>6 - 14</b>	Reserved	
<b>6 - 15</b>	Reserved	

## Group 7: Protection and Special Parameters

<b>7 - 00</b>	✓ Software Brake Level (the Action Level of the Brake Resistor)	Unit: 1
	Settings      230V series: 370 to 430V	Factory Setting: 380

 This parameter sets the DC-bus voltage at which the brake chopper is activated.

<b>7 - 01</b>	DC Brake Current Level	Unit: 0.1
	Settings      0.0 to 100.0%	Factory Setting: 0.0

 This parameter sets the level of DC Brake Current output to the motor during start-up and stopping. When setting DC Brake Current, the Rated Current (Pr.0-01) is regarded as 100%. It is recommended to start with a low DC Brake Current Level and then increase until proper holding torque has been attained.

<b>7 - 02</b>	DC Brake Time during Start-up	Unit: 0.1
	Settings      0.0 to 999.9 sec	Factory Setting: 0.0

 This parameter determines the duration of the DC Brake current after a RUN command. When the time has elapsed, the AC motor drive will start accelerating from the Minimum Frequency (Pr.1-05).

<b>7 - 03</b>	DC Brake Time during Stopping	Unit: 0.1
	Settings      0.0 to 999.9 sec	Factory Setting: 0.0

 This parameter determines the duration of the DC Brake current during stopping. If stopping with DC Brake is desired, Pr.0-13 Stop Method must be set to 00 for RAMP stop.

 When Pr.7-03 is set to 999.9, it will be permanent DC brake. There are two methods used to stop it.

1. It needs to force stopping by setting multi-inputs (MI1~MI5) to 9 or 10.
2. Pressing  key and holding for 2 seconds.

<b>7 - 04</b>	Start-Point for DC Brake	Unit: 0.01
	Settings      0.00 to 400.0Hz	Factory Setting: 0.00

 This parameter determines the frequency when DC Brake will begin during deceleration.

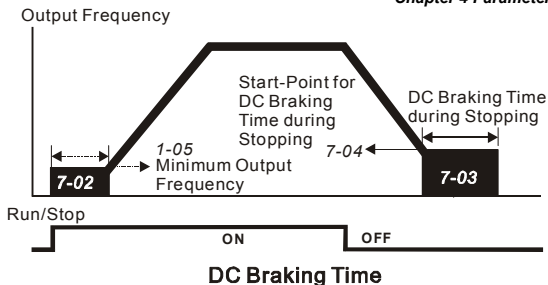

- 📖 DC Brake during Start-up is used for loads that may move before the AC drive starts. Under such circumstances, DC Brake can be used to hold the load in position before setting it in motion.
- 📖 DC Brake during stopping is used to shorten the stopping time and also to hold a stopped load in position. For high inertia loads, a dynamic brake resistor may also be needed for fast decelerations.

#### 7 - 05 Over-Torque Detection Mode (oL2)

Factory Setting: 00

Settings	00	Over-Torque detection disabled.
	01	Over-Torque detection enabled during constant speed operation. After over-torque is detected, keep running until oL2 occurs.
	02	Over-Torque detection enabled during constant speed operation. After over-torque is detected, stop running.
	03	Over-Torque detection enabled during acceleration/constant speed operation. After over-torque is detected, keep running until oL2 occurs.
	04	Over-Torque detection enabled during acceleration/constant speed operation. After over-torque is detected, stop running.

- 📖 This parameter determines the operation mode of the drive after the over-torque (oL2) is detected via the following method: if the output current exceeds the over-torque detection level (Pr.7-06) longer than the setting of Pr.7-07 Over-Torque Detection Time, the warning message "oL2" is displayed. If a Multi-Functional Output Terminal is to over-torque detection (Pr.6-00~6-07=03), the output is on. Please refer to Pr.6-00~6-07 for details.

#### 7 - 06 Over-Torque Detection Level (oL2)

Unit: 0.1

Settings 10.0 to 200.0%

Factory Setting: 150.0



 This setting is proportional to the Rated Output Current of the drive.

**7 - 07** Over-Torque Detection Time (oL2)

Unit: 0.1

Settings 0.1 to 60.0 sec

Factory Setting: 0.1

 This parameter sets the time for how long over-torque must be detected before "oL2" is displayed.

**7 - 08** Electronic Thermal Overload Relay Selection (oL1)

Factory Setting: 01

Settings 00 Operate with a Standard Motor (self-cooled by fan)  
 01 Operate with a Special Motor (forced external cooling)  
 02 Operation disabled

 This function is used to protect the motor from overloading or overheating.

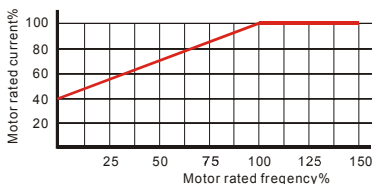

Self-cooled by fan

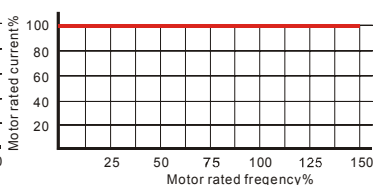

Forced external cooling

**7 - 09** Electronic Thermal Characteristic

Unit: 1



Settings 30 to 600 sec

Factory Setting: 60

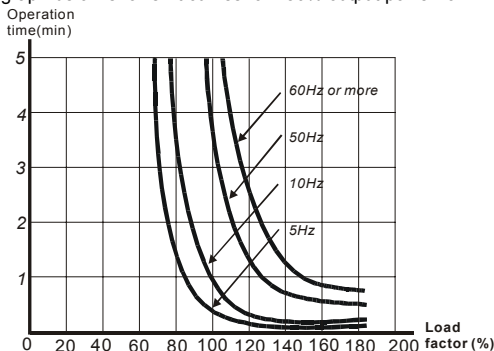

 The parameter determines the time required for activating the I<sup>2</sup>t electronic thermal protection function. The graph below shows I<sup>2</sup>t curves for 150% output power for 1 minute.





<b>7 - 10</b>	<b>Auto Restart After Fault</b>	Unit: 1
Settings	00 to 10	Factory Setting: 06
	00 Disable	

-  After fault occurs, such as oc, ov, oH, oL, oL1, ocA, ocd, ocn, oL2, PGEr, doEr, the AC motor drive can be reset/restarted automatically up to 10 times.
-  Setting this parameter to 0 will disable the reset/restart operation after any fault has occurred. When enabled, the AC motor drive will restart with speed search, which starts at the frequency before the fault. To set the waiting time before restart after a fault, please set Pr. 7-11 Delay Time for Speed Search.

<b>7 - 11</b>	<b>Delay Time for Speed Search</b>	Unit: 0.1
Settings	0.1 to 600.0 sec	Factory Setting: 2.0

-  This parameter should be set at a value to ensure that any residual regeneration voltage from the motor on the output has disappeared before the drive is activated again.
-  When restart after fault, this parameter also can be used as time setting of the speed search.
-  When using PG (encoder), speed search will begin at the actual PG (encoder) feedback speed.

<b>7 - 12</b>	<b>Current Limit for Speed Search</b>	Unit: 0.1
Settings	20.0 to 200.0%	Factory Setting: 150.0

-  For speed search, this parameter is used to limit the output current.
-  When executing speed search, it will run by the V/f curve set in group 1.

<b>7 - 13</b>	<b>Momentary Power Loss Operation Selection</b>	Factory Setting: 00
Settings	00 Speed search starts with the Master Frequency reference value.	
	01 Speed search starts with the minimum frequency.	

-  Refer to following diagram for details.

## Chapter 4 Parameters | VFD-M-D Series

Operation continues after fault clear,  
speed search starts with the Master  
Frequency reference value

7-13=00

Operation continues after fault clear,  
speed search starts with the minimum frequency

7-14=01

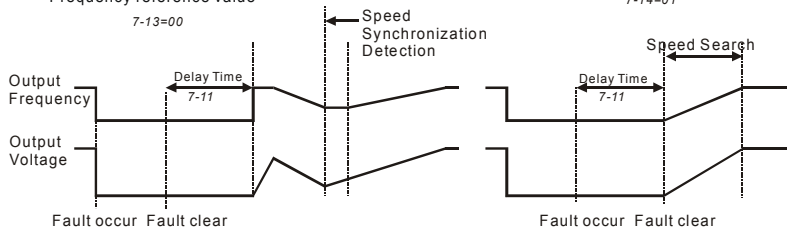

### 7 - 14 Auto Reset Time at Restart after Fault

Unit: 1

Settings 00 to 9999 sec

Factory Setting: 600

### 7 - 15 Present Fault Record

### 7 - 16 Second Most Recent Fault Record

### 7 - 17 Third Most Recent Fault Record

### 7 - 18 Fourth Recent Fault Record

Factory Setting: 00

Readings 00	No fault
01	Over-current (oc)
02	Over-voltage (ov)
03	Overheat (oH)
04	Overload (oL)
05	Overload1 (oL1)
06	External fault (EF)
07	Reserved
08	CPU failure (cF3)
09	Hardware protection failure (HPF)
10	Current exceeds 2 times rated current during accel.(ocA)
11	Current exceeds 2 times rated current during decel.(ocd)
12	Current exceeds 2 times rated current during steady state operation (ocn)
13	Ground fault (GFF)
14	Reserved
15	CPU READ failure (CF1)
16	CPU WRITE failure (CF2)
17	Reserved
18	Motor over load (oL2)
19	Reserved

20	Software/password protection (PcdE/Ccde)
21	Reserved
22	Reserved
23	Reserved
24	Reserved
25	Reserved
26	PG feedback signal error (PGEr)
27	Door open/close complete signal error (PSEr)
28	Door open time-out (doEr)
35	Communication time-out (CE10)

 In Pr.7-15 to Pr.7-18 the four most recent faults that occurred, are stored. After removing the cause of the fault, use the reset command to reset the drive.

<b>7 - 19</b>	Accumulative Motor Operation Time (Min.)	Unit: 1
Settings	00 to 1439 min	Factory Setting: 00

<b>7 - 20</b>	Accumulative Motor Operation Day	Unit: 1
Settings	00 to 9999 day	Factory Setting: 00

 Pr.7-19 and Pr.7-20 are used to record the motor operation time. They can be cleared by setting to 00 and time is less than 60 seconds is not recorded.

<b>7 - 21</b>	Deceleration Method for Emergency Stop/Forced Stop	Factory Setting: 00
Settings	00 According to the fast deceleration time (Pr.4-14)	
	01 According to door open/close deceleration time 1 (Pr.3-08/4-06)	
	02 According to door open/close deceleration time 2 (Pr.3-11/4-09)	
	03 According to DC brake time during stopping	
	04 Free run to stop	

 The drive will act according to Pr.7-21 if any of the following situations happens:

1. One of multi-function input terminals is set to 11/12
2. PG feedback signal is error and Pr.02-20 is set to 01
3. Door open time-out occurs

**Pr.7-21 = 00**

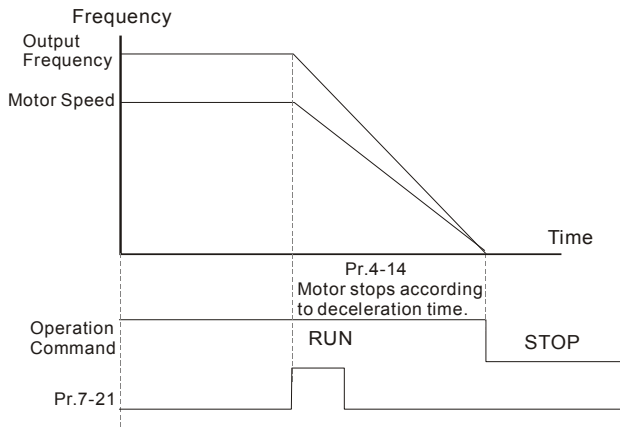

**Pr.7-21 = 01**

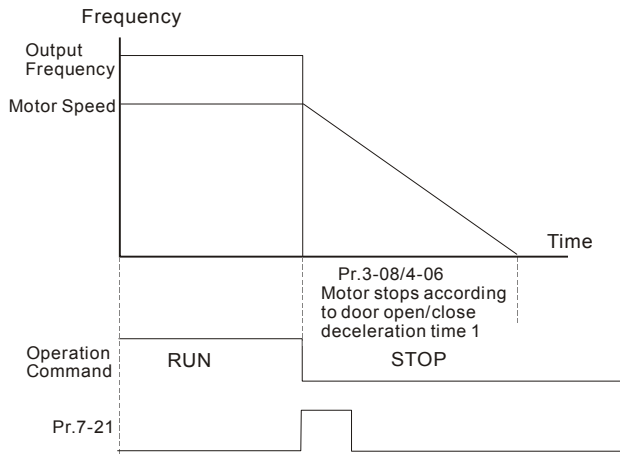

**Pr.7-21 = 02**

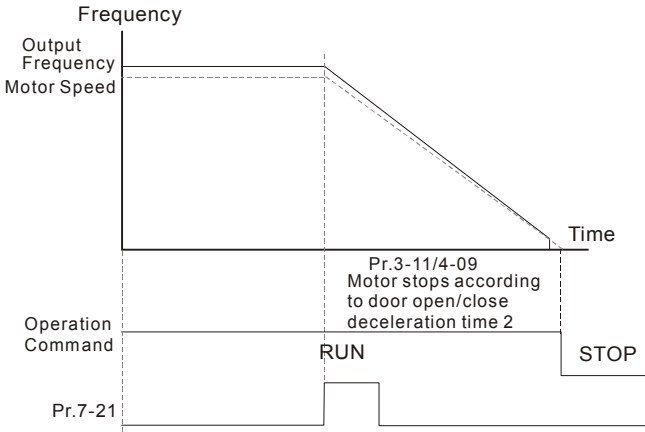

**Pr.7-21 = 03**

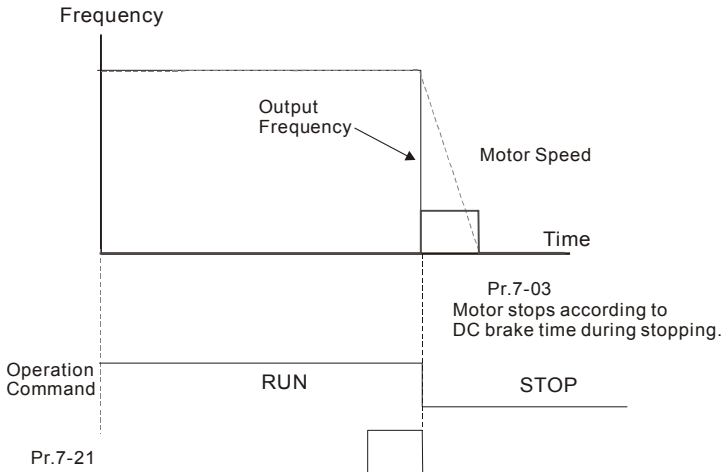

Pr.7-21 = 04

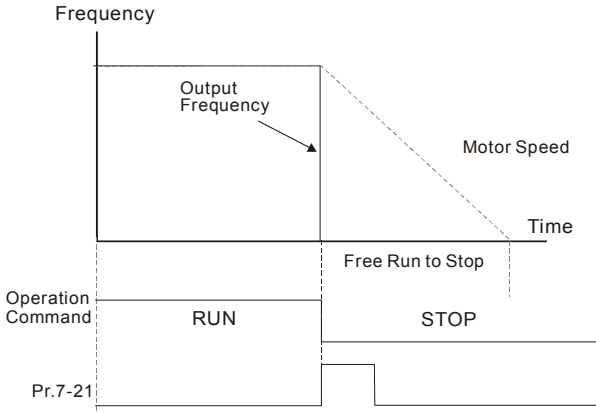

**Group 8: Communication Parameters**

There is a built-in RS-485 serial interface, marked RJ-11(jack) near to the control terminals. The pins are defined below:

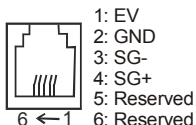

NOTE: 1. When connecting to the communication connector, please use RJ11 6P2C/6P4C

2. When connecting to the PU, please use RJ12.

Each VFD-M-D AC drive has a pre-assigned communication address specified by Pr.8-00. The RS485 master then controls each AC motor drive according to its communication address.

**8 - 00** Communication Address

Settings      01 to 254      Factory Setting: 01

If the AC motor drive is controlled by RS-485 serial communication, the communication address for this drive must be set via this parameter. And the communication address for each AC motor drive must be different and unique.

**8 - 01** Transmission Speed

Factory Setting: 02

Settings	00	Baud rate 4800 bps (bits / second)
	01	Baud rate 9600 bps
	02	Baud rate 19200 bps
	03	Baud rate 38400 bps

This parameter is used to set the transmission speed between the RS485 master (PLC, PC, etc.) and AC motor drive.

**8 - 02** Transmission Fault Treatment

Factory Setting: 03

Settings	00	Warn and keep operating
	01	Warn and RAMP to stop
	02	Warn and COAST to stop
	03	No warning and keep operating

This parameter is set to how to react if transmission errors occur.

See list of error messages below (see section 3.6.)



**8 - 03** ✓ Time-out Detection

Unit: 0.1

Settings	0.0 ~ 60.0 sec	Factory Setting: 0.0
	0.0 Disable	

 If Pr.8-03 is not equal to 0.0, Pr.8-02=00~02, and there is no communication on the bus during the Time Out detection period (set by Pr.8-03), "cE10" will be shown on the keypad.

**8 - 04** ✓ Communication Protocol

Factory Setting: 03

Settings	00	Modbus ASCII mode, protocol <7,N,2>
	01	Modbus ASCII mode, protocol <7,E,1>
	02	Modbus ASCII mode, protocol <7,O,1>
	03	Modbus RTU mode, protocol <8,N,2>
	04	Modbus RTU mode, protocol <8,E,1>
	05	Modbus RTU mode, protocol <8,O,1>

 1. Control by PC or PLC

★ A VFD-M-D can be set up to communicate on Modbus networks using one of the following modes: ASCII (American Standard Code for Information Interchange) or RTU (Remote Terminal Unit). Users can select the desired mode along with the serial port communication protocol in Pr.8-04.

★ Code Description:

**ASCII mode:**

Each 8-bit data is the combination of two ASCII characters. For example, a 1-byte data: 64 Hex, shown as '64' in ASCII, consists of '6' (36Hex) and '4' (34Hex).

Character	'0'	'1'	'2'	'3'	'4'	'5'	'6'	'7'
ASCII code	30H	31H	32H	33H	34H	35H	36H	37H

Character	'8'	'9'	'A'	'B'	'C'	'D'	'E'	'F'
ASCII code	38H	39H	41H	42H	43H	44H	45H	46H

**RTU mode:**

Each 8-bit data is the combination of two 4-bit hexadecimal characters. For example, 64 Hex.



## 2. Data Format

10-bit character frame (For ASCII):

(7.N.2)

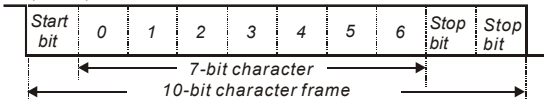

(7.E.1)

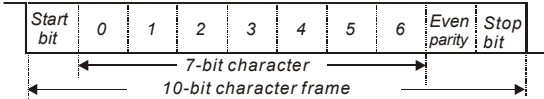

(7.O.1)

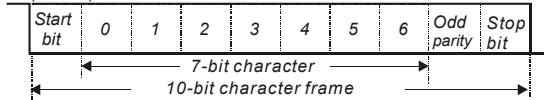

11-bit character frame (For RTU):

(8.N.2)

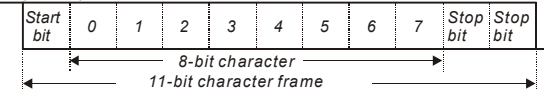

(8.E.1)

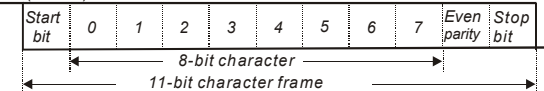

(8.O.1)

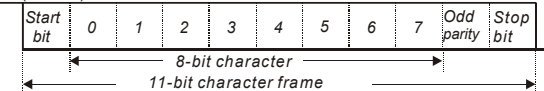

## 3. Communication Protocol

3.1 Communication Data Frame:

**ASCII mode:**

STX	Start character ':' (3AH)
Address Hi	Communication address:
Address Lo	8-bit address consists of 2 ASCII codes
Function Hi	Command code:
Function Lo	8-bit command consists of 2 ASCII codes
DATA (n-1) to DATA 0	Contents of data: Nx8-bit data consist of 2n ASCII codes n<=20, maximum of 40 ASCII codes
LRC CHK Hi	LRC check sum:
LRC CHK Lo	8-bit check sum consists of 2 ASCII codes
END Hi	End characters:
END Lo	END1= CR (0DH), END0= LF(0AH)

**RTU mode:**

START	A silent interval of more than 10 ms
Address	Communication address: 8-bit address
Function	Command code: 8-bit command
DATA (n-1) to DATA 0	Contents of data: n×8-bit data, n≤40 (20 x 16-bit data)
CRC CHK Low	CRC check sum: 16-bit check sum consists of 2 8-bit characters
CRC CHK High	
END	A silent interval of more than 10 ms

**3.2 Address (Communication Address)**

Valid communication addresses are in the range of 0 to 254. A communication address equal to 0, means broadcast to all AC drives (AMD). In this case, the AMD will not reply any message to the master device.

00H: broadcast to all AC drives

01H: AC drive of address 01

0FH: AC drive of address 15

10H: AC drive of address 16

:

FEH: AC drive of address 254

For example, communication to AMD with address 16 decimal (10H):

ASCII mode: Address='1','0' => '1'=31H, '0'=30H

RTU mode: Address=10H

**3.3 Function (Function code) and DATA (data characters)**

The format of data characters depends on the function code.

03H: read data from register

06H: write single register

08H: loop detection

10H: write multiple registers

The available function codes and examples for VFD-M-D are described as follows:

(1) 03H: multi read, read data from registers.

Example: reading continuous 2 data from register address 2102H, AMD address is 01H.

ASCII mode:

Command message:

STX	'.'
Address	'0'
	'1'
Function	'0'
	'3'
Starting data address	'2'
	'1'
	'0'
	'2'
Number of data (count by word)	'0'
	'0'
	'0'
	'2'
LRC Check	'D'
	'7'
END	CR
	LF

Response message:

STX	'.'
Address	'0'
	'1'
Function	'0'
	'3'
Number of data (Count by byte)	'0'
	'4'
Content of starting address 2102H	'1'
	'7'
	'7'
	'0'
Content of address 2103H	'0'
	'0'
	'0'
	'0'
LRC Check	'7'
	'1'
END	CR
	LF

RTU mode:

Command message:

Address	01H
Function	03H
Starting data address	21H
	02H
Number of data (count by word)	00H
	02H
CRC CHK Low	6FH
CRC CHK High	F7H

Response message:

Address	01H
Function	03H
Number of data (count by byte)	04H
Content of address 2102H	17H
	70H
Content of address 2103H	00H
	00H
CRC CHK Low	FEH
CRC CHK High	5CH

(2) 06H: single write, write single data to register.

Example: writing data 6000(1770H) to register 0100H. AMD address is 01H.

ASCII mode:

Command message:

STX	'.'
Address	'0'
	'1'
Function	'0'
	'6'
Data address	'0'
	'1'
	'0'
	'0'
Data content	'1'
	'7'
	'7'

Response message:

STX	'.'
Address	'0'
	'1'
Function	'0'
	'6'
Data address	'0'
	'1'
	'0'
	'0'
Data content	'1'
	'7'
	'7'

Command message:

	'0'
LRC Check	'7'
	'1'
END	CR
	LF

Response message:

	'0'
LRC Check	'7'
	'1'
END	CR
	LF

RTU mode:

Command message:

Address	01H
Function	06H
Data address	01H
	00H
Data content	17H
	70H
CRC CHK Low	86H
CRC CHK High	22H

Response message:

Address	01H
Function	06H
Data address	01H
	00H
Data content	17H
	70H
CRC CHK Low	86H
CRC CHK High	22H

(3) 08H: loop detection

This command is used to know if the communication between master device (PC or PLC) and drive is normal. The drive will send back the received data to master device.

ASCII Mode:

Command message:

STX	':'
Address 1	'0'
Address 0	'1'
Function 1	'0'
Function 0	'8'
Data address	'0'
	'0'
	'0'
	'0'
Data content	'1'
	'7'
	'7'
	'0'
LRC Check	'7'
	'0'
END	CR
	LF

Response message:

STX	':'
Address 1	'0'
Address 0	'1'
Function 1	'0'
Function 0	'8'
Data address	'0'
	'0'
	'0'
	'0'
Data content	'1'
	'7'
	'7'
	'0'
LRC Check	'7'
	'0'
END	CR
	LF

RTU mode:

Command message:

Address	01H
Function	08H
Data	00H
	00H
Data	17H
	70H
CRC Check Low	8EH
CRC Check High	0EH

Response message:

Address	01H
Function	08H
Data	00H
	00H
Data	17H
	70H
CRC Check Low	8EH
CRC Check High	0EH

(4) 10H: write multiple registers (write multiple data to registers)

Example: Set the multi-step speed,

Pr.5-00=50.00 (1388H), Pr.5-01=40.00 (0FA0H). AC drive address is 01H.

ASCII Mode:

Command message:

STX	':'
Address 1	'0'
Address 0	'1'
Function 1	'1'
Function 0	'0'
	'0'
Starting data address	'5'
	'0'
	'0'
	'0'
Number of data (count by word)	'0'
	'0'
	'2'
Number of data (count by byte)	'0'
	'4'
The first data content	'1'
	'3'
	'8'
	'8'
The second data content	'0'
	'F'
	'A'
	'0'
LRC Check	'9'
	'A'
END	CR
	LF

Response message:

STX	':'
Address 1	'0'
Address 0	'1'
Function 1	'1'
Function 0	'0'
	'0'
Starting data address	'5'
	'0'
	'0'
	'0'
Number of data (count by word)	'0'
	'0'
	'2'
LRC Check	'E'
	'8'
END	CR
	LF

RTU mode:

Command message:

Address	01H
Function	10H
Starting data address	05H
	00H
Number of data (count by word)	00H'
	02H
Number of data (count by byte)	04
The first data content	13H
	88H
The second data content	0FH
	A0H
CRC Check Low	'9'
CRC Check High	'A'

Response message:

Address	01H
Function	10H
Starting data address	05H
	00H
Number of data (count by word)	00H
	02H
CRC Check Low	41H
CRC Check High	04H

## 3.4 Check sum

ASCII mode:

LRC (Longitudinal Redundancy Check) is calculated by summing up, module 256, the values of the bytes from ADR1 to last data character then calculating the hexadecimal representation of the 2's-complement negation of the sum.

For example, reading 1 word from address 0401H of the AC drive with address 01H.

STX	':'
Address 1	'0'
Address 0	'1'
Function 1	'0'
Function 0	'3'
Starting data address	'0'
	'4'
	'0'
	'1'
Number of data	'0'
	'0'
	'0'
	'1'
LRC Check 1	'F'
LRC Check 0	'6'
END 1	CR
END 0	LF

01H+03H+04H+01H+00H+01H=0AH, the 2's-complement negation of 0AH is **F6H**.

RTU mode:

Address	01H
Function	03H
Starting data address	21H
	02H
Number of data (count by word)	00H
	02H
CRC CHK Low	6FH
CRC CHK High	F7H

CRC (Cyclical Redundancy Check) is calculated by the following steps:

**Step 1:** Load a 16-bit register (called CRC register) with FFFFH.

**Step 2:** Exclusive OR the first 8-bit byte of the command message with the low order byte of the 16-bit CRC register, putting the result in the CRC register.

**Step 3:** Examine the LSB of CRC register.

**Step 4:** If the LSB of CRC register is 0, shift the CRC register one bit to the right with MSB zero filling, then repeat step 3. If the LSB of CRC register is 1, shift the CRC register one bit to the right with MSB zero filling, Exclusive OR the CRC register with the polynomial value A001H, then repeat step 3.

**Step 5:** Repeat step 3 and 4 until eight shifts have been performed. When this is done, a complete 8-bit byte will have been processed.

**Step 6:** Repeat step 2 to 5 for the next 8-bit byte of the command message. Continue doing this until all bytes have been processed. The final contents of the CRC register are the CRC value. When transmitting the CRC value in the message, the upper and lower bytes of the CRC value must be swapped, i.e. the lower order byte will be transmitted first.

The following is an example of CRC generation using C language. The function takes two arguments:

Unsigned char\* data ← a pointer to the message buffer

Unsigned char length ← the quantity of bytes in the message buffer

The function returns the CRC value as a type of unsigned integer.

```
Unsigned int crc_chk(unsigned char* data, unsigned char length){
    int j;
    unsigned int reg_crc=0xFFFF;
    while(length--){
        reg_crc ^= *data++;
        for(j=0;j<8;j++){
            if(reg_crc & 0x01){ /* LSB(b0)=1 */
                reg_crc=(reg_crc>>1) ^ 0xA001;
            }else{
                reg_crc=reg_crc >>1;
            }
        }
    }
    return reg_crc;
}
```

### 3.5 Address list

The contents of available addresses are shown as below:



Content	Address	Function	
AC drive Parameters	GGnnH	GG means parameter group, nn means parameter number, for example, the address of Pr 4-01 is 0401H. Referencing to chapter 5 for the function of each parameter. When reading parameter by command code 03H, only one parameter can be read at one time.	
Command Write only	2000H	Bit 0-1	00B: No function 01B: Stop 10B: Run 11B: Jog + Run
		Bit 2-3	Reserved
		Bit 4-5	00B: No function 01B: FWD 10B: REV 11B: Change direction
		Bit 6-7	00B: 1st Step Door Open Accel/Decel 01B: 1st Step Door Close Accel/Decel 10B: 2nd Step Door Open Accel/Decel 11B: 2nd Step Door Close Accel/Decel
		Bit 8-11	0000B: 1st Step Speed Frequency
			0001B: 2nd Step Speed Frequency
			0010B: 3rd Step Speed Frequency
			0011B: 4th Step Speed Frequency
			0100B: 5th Step Speed Frequency
			0101B: 6th Step Speed Frequency
			0110B: 7th Step Speed Frequency
			0111B: 8th Step Speed Frequency
			1000B: 9th Step Speed Frequency
			1001B: 10th Step Speed Frequency
			1010B: 11th Step Speed Frequency
		1011B: 12th Step Speed Frequency	
1100B: 13th Step Speed Frequency			
1101B: 14th Step Speed Frequency			
1110B: 15th Step Speed Frequency			
1111B: 16th Step Speed Frequency			
Bit 12	Select the function of Bit6~11		
Bit 13-15	Reserved		

Content	Address	Function		
Command Write only	2001H	Reserved		
	2002H	Bit 0	1: EF (external fault) on	
		Bit 1	1: Reset	
		Bit 2	Reserved	
	2006H	Multi-function Input Terminals (COM1~COM4)		
		Bit 0	COM1	
Bit 1		COM2		
Bit 2		COM3		
Bit 3		COM4		
Status monitor Read only	2100H	Error code:		
		00: No error occurred		
		01: Over-current (oc)		
		02: Over-voltage (ov)		
		03: Overheat (oH)		
		04: Overload (oL)		
		05: Overload1 (oL1)		
		06: External fault (EF)		
		07: Reserved		
		08: CPU failure (cF3.3~cF3.8)		
		09: Hardware protection failure (HPF.1~HPF.4)		
		10: Current exceeds 2 times rated current during accel (ocA)		
		11: Current exceeds 2 times rated current during decel (ocd)		
		12: Current exceeds 2 times rated current during steady state operation (ocn)		
		13: Ground Fault (GFF)		
		14: Reserved		
		15: CPU failure 1 (cF1)		
		16: CPU failure 2 (cF2)		
		17: Reserved		
		18: Overload (oL2)		
		19: Reserved		
		20: Software/password protection (PcdE/Ccde)		
21: Reserved				
22: Reserved				
23: Reserved				

Content	Address	Function	
Status monitor Read only	2100H	24: Reserved	
		25: Reserved	
		26: PG feedback error (PGEr)	
		27: Door open/close complete signal error (PSEr)	
		28: Door open time-out (doEr)	
		35: Communication time-out (cE10)	
	2101H	Status of AC drive	
		Bit 0-4	LED: 0: light off, 1: light up
			00: RUN LED
			01: STOP LED
			02: JOG LED
			03: FWD LED
			04: REV LED
		Bit 5~9	Reserved
		Bit 10	1: Operation command controlled by communication interface
		Bit 11	1: Parameters have been locked
		Bit 12	0: AC drive stops, 1: AC drive operates
		Bit 13	1: Jog command
		Bit 14-15	Reserved
	2102H	Frequency command (F)	
	2103H	Output frequency (H)	
	2104H	Output current (A)	
	2105H	DC-BUS Voltage (u)	
	2106H	Output voltage (E)	
	2107H	Step number of Multi-Step Speed Operation	
	2108H	The pulse number for the walking distance (c)	
	2109H	Display the walking distance and step speed (x.yy.y)	
	210AH	Power factor angle	
	210BH	Estimated torque ratio	
	210CH	Motor speed (rpm)	
	210DH	PG pulse (low word) /unit time	
	210EH	PG pulse (high word) /unit time	
	210FH	Output power (KW)	
2110H	Reserved		

Content	Address	Function	
Status monitor Read only	2200H	Reserved	
	2201H	User-defined (Low word)	
	2202H	User-defined (High word)	
	2203H	Reserved	
	2204H	Reserved	
	2205H	Reserved	
	2206H	Display temperature of heatsink (°C)	
	2207H	Reserved	
	2208H	Reserved	
	2209H	Multi-function output terminals MO3~MO6	
		Bit0	MO3
		Bit1	MO4
		Bit2	MO5
		Bit3	MO6
	220AH	Warning Code	
		08: auto tuning error (AUE)	
		09: parameter copy failure (SE1)	
		10: parameter copy check failure (SE2)	
		18: overload (oL2)	
26: PG feedback error (PGEr)			
27: limit signal error (PSEr)			
31: illegal function code (cE01)			
32: illegal data address (cE02)			
33: illegal data value (cE03)			
34: slave device failure (cE04)			
35: communication time-out (cE10)			

### 3.6 Exception response:

The AC motor drive is expected to return a normal response after receiving command messages from the master device. The following depicts the conditions when no normal response is replied to the master device.

The AC motor drive does not receive the messages due to a communication error; thus, the AC motor drive has no response. The master device will eventually process a timeout condition.

The AC motor drive receives the messages without a communication error, but cannot handle them. An exception response will be returned to the master device and an error message "CExx" will be displayed on the keypad of AC motor drive. The xx of "CExx" is a decimal code equal to the exception code that is described below.

In the exception response, the most significant bit of the original command code is set to 1, and an exception code which explains the condition that caused the exception is returned.

Example of an exception response of command code 06H and exception code 02H:

**ASCII mode:**

STX	':'
Address Low	'0'
Address High	'1'
Function Low	'8'
Function High	'6'
Exception code	'0'
	'2'
LRC CHK Low	'7'
LRC CHK High	'7'
END 1	CR
END 0	LF

**RTU mode:**

Address	01H
Function	86H
Exception code	02H
CRC CHK Low	C3H
CRC CHK High	A1H

The explanation of exception codes:

Exception code	Explanation
01	Illegal function code: The function code received in the command message is not available for the AC motor drive.
02	Illegal data address: The data address received in the command message is not available for the AC motor drive.
03	Illegal data value: The data value received in the command message is not available for the AC drive.
04	Slave device failure: The AC motor drive is unable to perform the requested action.
10	Communication time-out: If Pr.8-03 is not equal to 0.0, Pr.8-02=00~02, and there is no communication on the bus during the Time Out detection period (set by Pr.8-03), "cE10" will be shown on the keypad.

## 3.7 Communication program of PC:

The following is a simple example of how to write a communication program for Modbus ASCII mode on a PC by C language.

```
#include<stdio.h>
```

```
#include<dos.h>
```

```

#include<conio.h>
#include<process.h>
#define PORT 0x03F8 /* the address of COM1 */
/* the address offset value relative to COM1 */
#define THR 0x0000
#define RDR 0x0000
#define BRDL 0x0000
#define IER 0x0001
#define BRDH 0x0001
#define LCR 0x0003
#define MCR 0x0004
#define LSR 0x0005
#define MSR 0x0006
unsigned char rdat[60];
/* read 2 data from address 2102H of AC drive with address 1 */
unsigned char tdat[60]={':','0','1','0','3','2','1','0','2','0','0','0','2','D','7','\r','\n'};
void main(){
int i;
outportb(PORT+MCR,0x08); /* interrupt enable */
outportb(PORT+IER,0x01); /* interrupt as data in */
outportb(PORT+LCR,(inportb(PORT+LCR) | 0x80));
/* the BRDL/BRDH can be access as LCR.b7==1 */
outportb(PORT+BRDL,12); /* set baudrate=9600, 12=115200/9600*/
outportb(PORT+BRDH,0x00);
outportb(PORT+LCR,0x06); /* set protocol, <7,N,2>=06H, <7,E,1>=1AH,
<7,O,1>=0AH, <8,N,2>=07H, <8,E,1>=1BH, <8,O,1>=0BH */
for(i=0;i<=16;i++){
while(!(inportb(PORT+LSR) & 0x20)); /* wait until THR empty */
outportb(PORT+THR,tdat[i]); /* send data to THR */ }
i=0;
while(!kbhit()){
if(inportb(PORT+LSR) & 0x01){ /* b0==1, read data ready */
rdat[i++]=inportb(PORT+RDR); /* read data form RDR */
} } }

```

 This parameter is the response delay time after AC drive receives communication command as shown in the following.

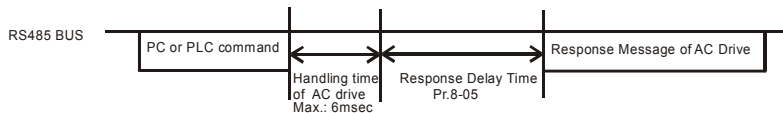

## 4.3 The Flow Chart for Parameter Settings

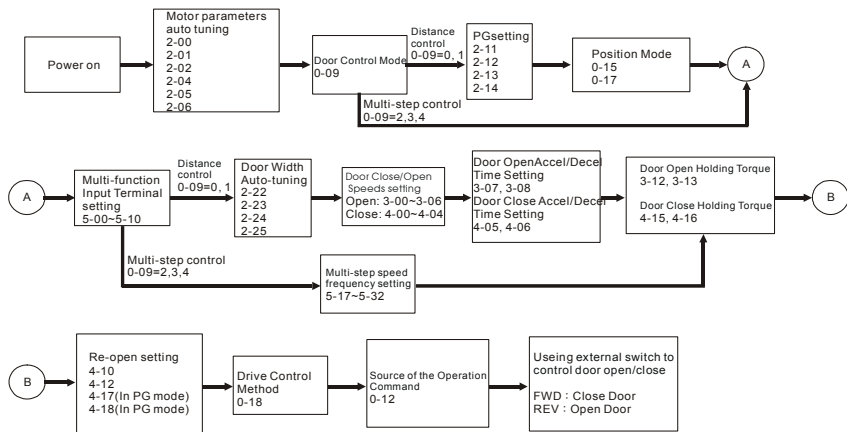



This page intentionally left blank.

# Chapter 5 Troubleshooting

## 5.1 Over Current (OC)

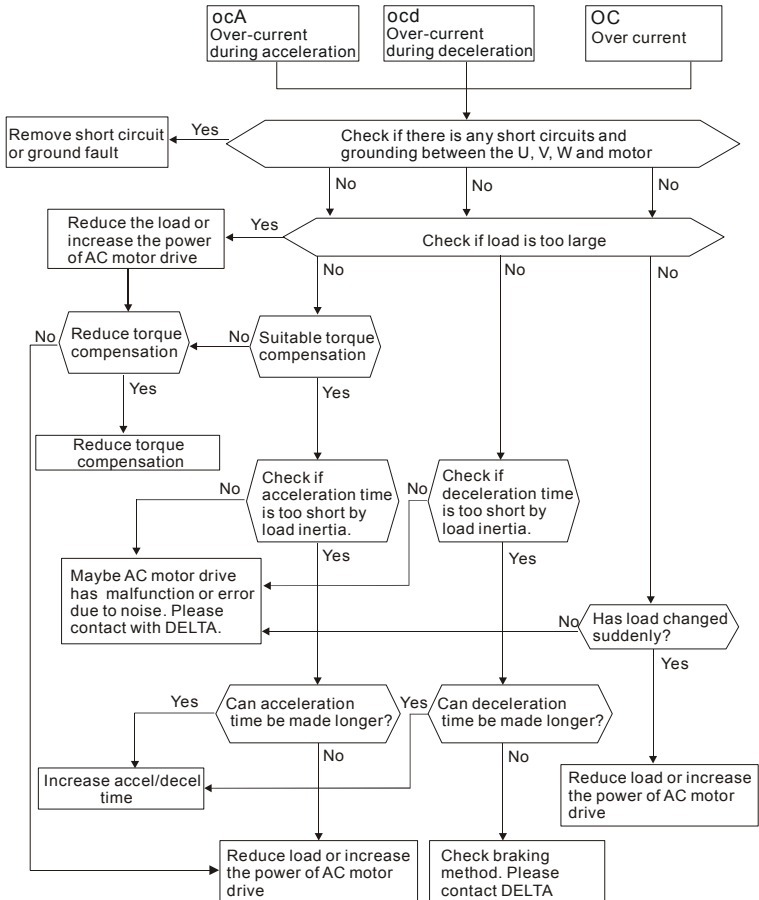

## 5.2 Ground Fault

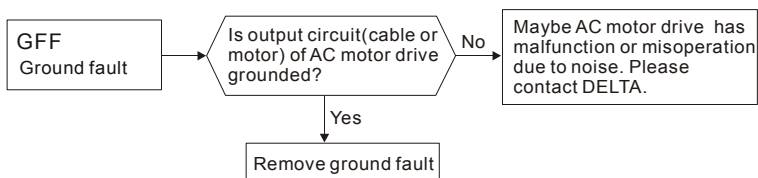

## 5.3 Over Voltage (OV)

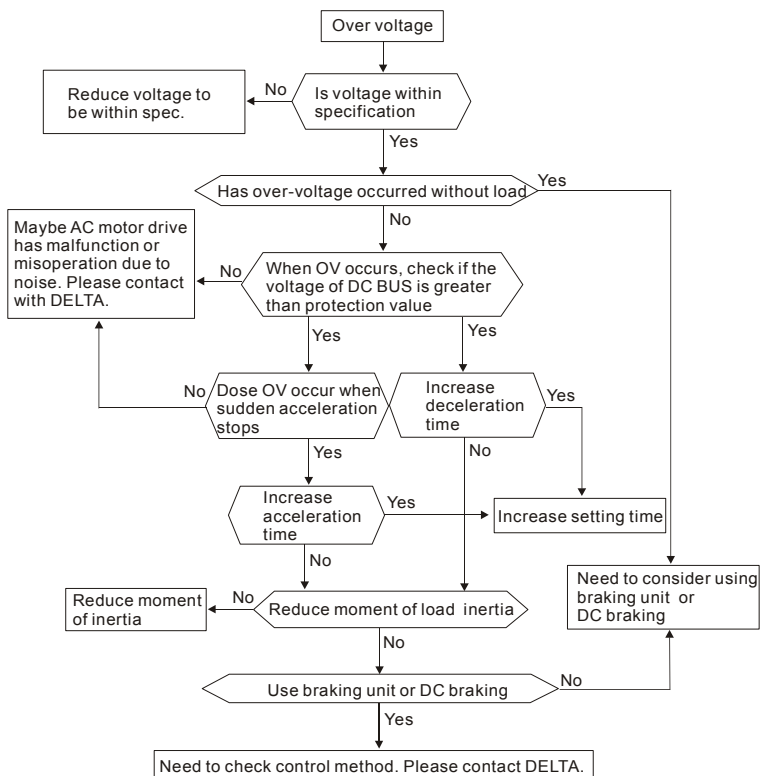

## 5.4 Low Voltage (Lv)

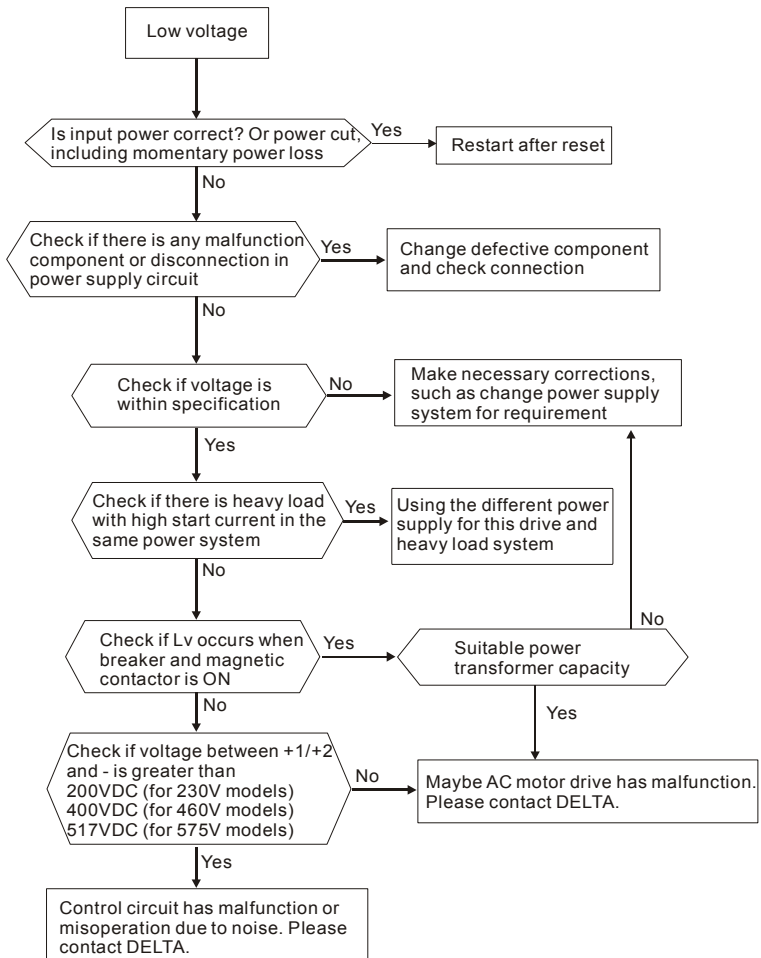

## 5.5 Over Heat (OH)

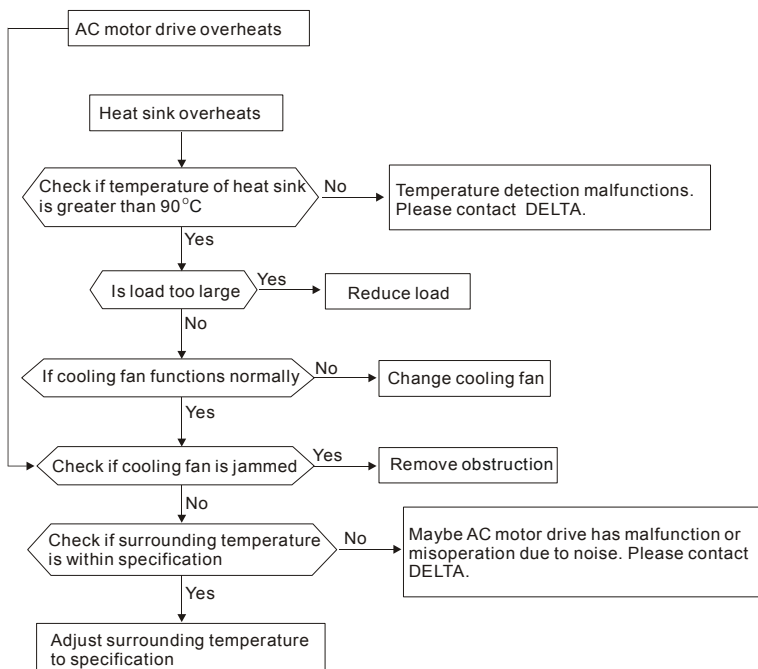

## 5.6 Overload

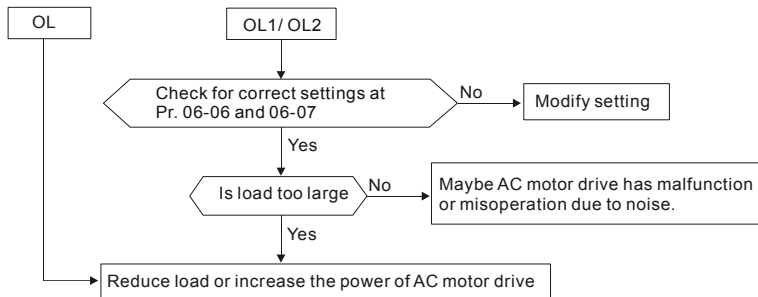

## 5.7 Display of LC-M2E is Abnormal

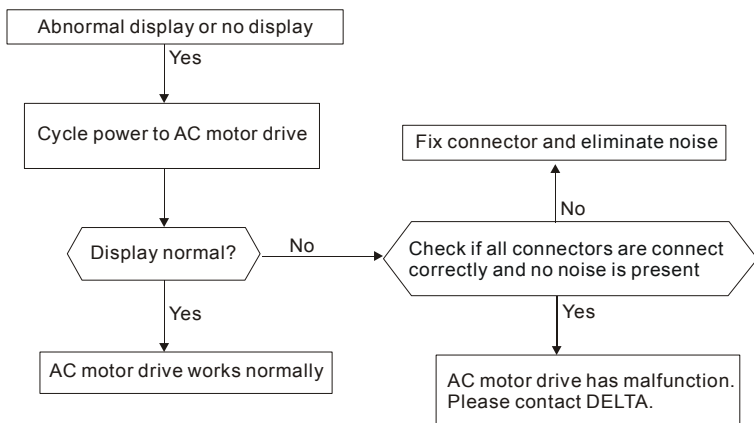

## 5.8 Phase Loss (PHL)

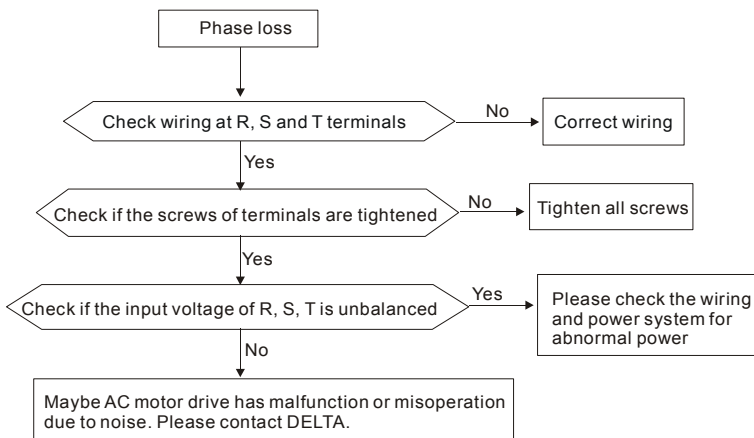

## 5.9 Motor cannot Run

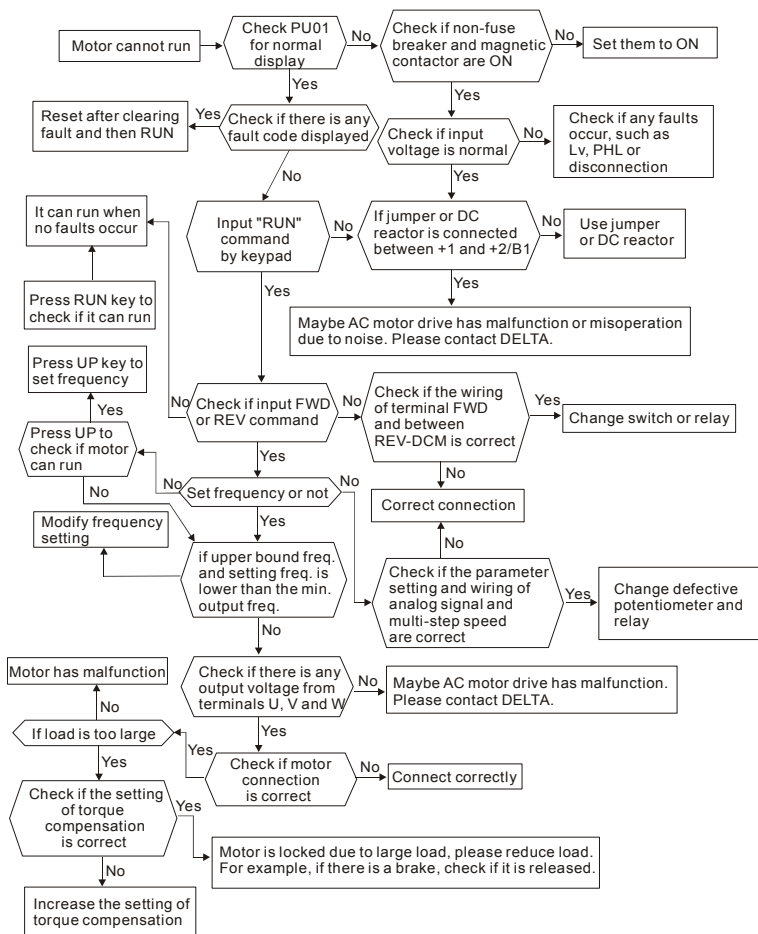

## 5.10 Motor Speed cannot be Changed

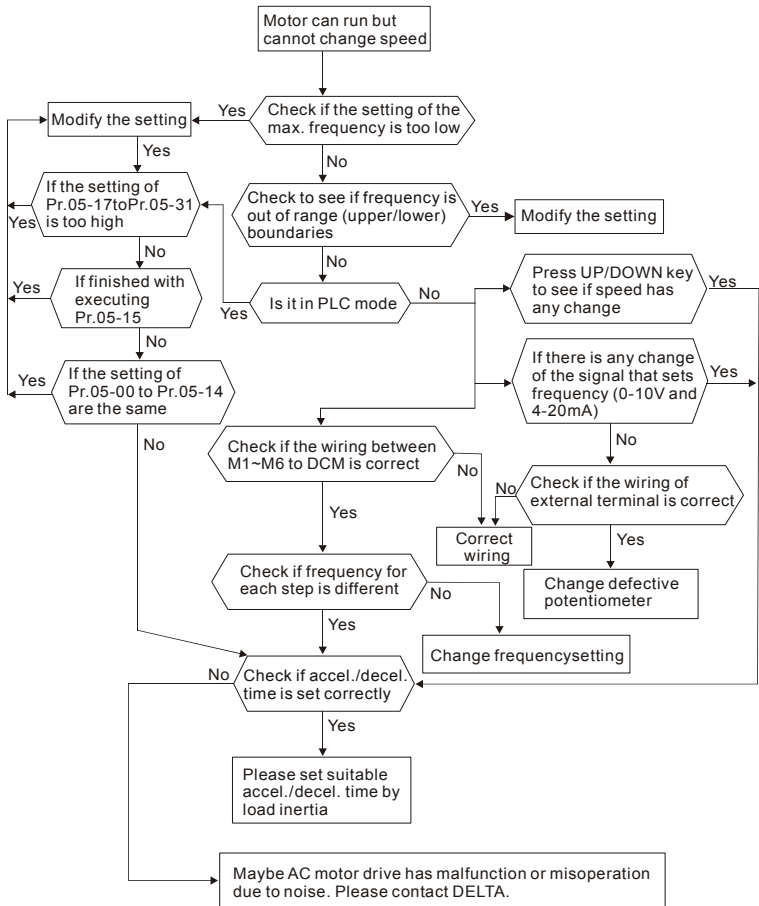



## 5.11 Motor Stalls during Acceleration

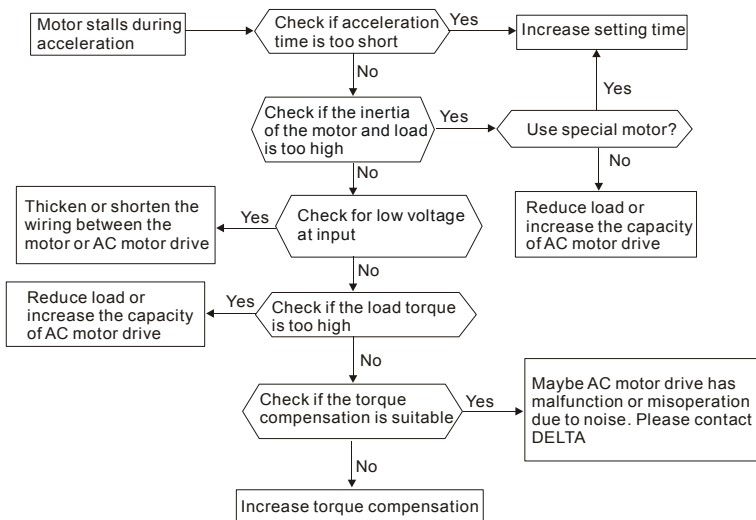

## 5.12 The Motor does not Run as Expected

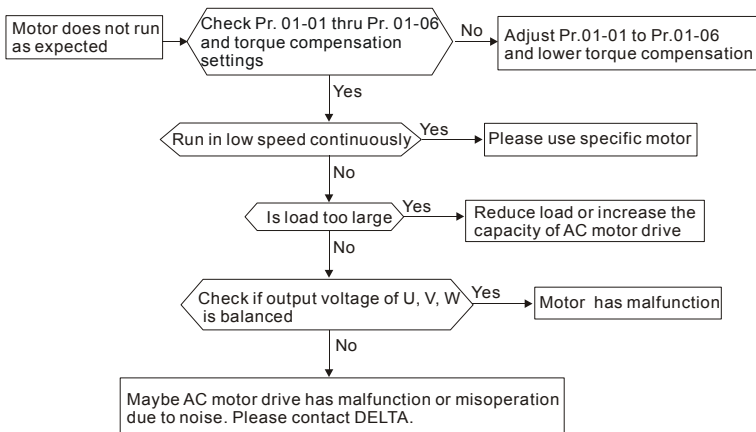

## 5.13 Electromagnetic/Induction Noise

There are many noises surround the AC motor drives and invade it by radiation or power circuit. It may cause the misoperation of control circuit and even damage the AC motor drive. Of course, that is a solution to increase the noise tolerance of AC motor drive. But it is not the best one due to the limit. Therefore, solve it from the outside as following will be the best.

1. Add surge suppressor on the relay or contact to suppress switching surge between ON/OFF.
2. Shorten the wiring length of the control circuit or serial circuit and separate from the main AC circuit wiring.
3. Comply with the wiring regulation for those shielded wire and use isolation amplifier for long wire length.
4. The grounding terminal should comply with the local regulation and ground independently, i.e. not to have common ground with electric welding machine and power equipment.
5. Connect a noise filter at the input terminal of the AC motor drive to prevent noise from power circuit.

In a word, three-level solutions for electromagnetic noise are “no product”, “no spread” and “no receive”.

## 5.14 Environmental Condition

Since the AC motor drive is an electronic device, you should comply with the environmental condition stated in the Chapter 1.2.1. Following are the remedial measures for necessary.

1. To prevent vibration, anti-vibration spacer is the last choice. The vibration tolerance must be within the specification. The vibration effect is equal to the mechanical stress and it cannot occur frequently, continuously or repeatedly to prevent damaging to the AC motor drive.
2. Store in a clean and dry location free from corrosive fumes/dust to prevent corrosion and poor contacts. It also may cause short by low insulation in a humid location. The solution is to use both paint and dust-proof. For particular occasion, use the enclosure with whole-seal structure.
3. The surrounding temperature should be within the specification. Too high or low temperature will affect the lifetime and reliability. For semiconductor components, damage will occur once any specification is out of range. Therefore, it is necessary to clean and periodical check for the air cleaner and cooling fan besides having cooler and sunshade. In additional, the microcomputer may not work in extreme low temperature and needs to have heater.
4. Store within a relative humidity range of 0% to 90% and non-condensing environment. Do not turn off the air conditioner and have exsiccator for it.

## 5.15 Affecting Other Machines

AC motor drive may affect the operation of other machine due to many reasons. The solutions are as follows.

### ■ High Harmonic at Power Side

If there is high harmonic at power side during running, the improved methods are:

1. Separate power system: use transformer for AC motor drive.
2. Use reactor at the power input terminal of AC motor drive or decrease high harmonic by multiple circuit.
3. If phase lead capacitors are used (never on the AC motor drive output!!), use serial reactors to prevent capacitors damage from high harmonics.

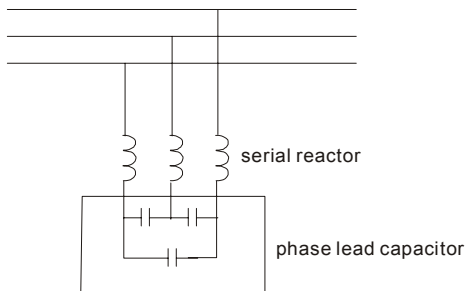

### ■ Motor Temperature Rises

When the motor is induction motor with ventilation-cooling-type used in variety speed operation, bad cooling will happen in the low speed. Therefore, it may overheat. Besides, high harmonic is in output waveform to increase copper loss and iron loss. Following measures should be used by load situation and operation range when necessary.

1. Use the motor with independent power ventilation or increase the horsepower.
2. Use inverter duty motor.
3. Do NOT run at low speeds for long time.

## Chapter 6 Fault Code Information and Maintenance

### 6.1 Fault Code Information

The AC motor drive has a comprehensive fault diagnostic system that includes several different alarms and fault messages. Once a fault is detected, the corresponding protective functions will be activated. The following faults are displayed as shown on the AC motor drive digital keypad display. The four most recent faults can be read from the digital keypad or communication.



#### NOTE

Wait 5 seconds after a fault has been cleared before performing reset via keypad or input terminal.

#### 6.1.1 Common Problems and Solutions

Fault Name	Fault Descriptions	Corrective Actions
OC	<p><b>Over current</b> Abnormal increase in current.</p>	<ol style="list-style-type: none"> <li>1. Check if motor power corresponds with the AC motor drive output power.</li> <li>2. Check the wiring connections to U, V, W for possible short circuits.</li> <li>3. Check the wiring connections between the AC motor drive and motor for possible short circuits, also to ground.</li> <li>4. Check for loose contacts between AC motor drive and motor.</li> <li>5. Increase the Acceleration Time.</li> <li>6. Check for possible excessive loading conditions at the motor.</li> <li>7. If there are still any abnormal conditions when operating the AC motor drive after a short-circuit is removed and the other points above are checked, it should be sent back to manufacturer.</li> </ol>
OV	<p><b>Over voltage</b> The DC bus voltage has exceeded its maximum allowable value.</p>	<ol style="list-style-type: none"> <li>1. Check if the input voltage falls within the rated AC motor drive input voltage range.</li> <li>2. Check for possible voltage transients.</li> <li>3. DC-bus over-voltage may also be caused by motor regeneration. Either increase the Decel. Time or add an optional brake resistor (and brake unit).</li> <li>4. Check whether the required brake power is within the specified limits.</li> </ol>

Fault Name	Fault Descriptions	Corrective Actions
OH	<b>Overheating</b> Heat sink temperature too high	<ol style="list-style-type: none"> <li>1. Ensure that the ambient temperature falls within the specified temperature range.</li> <li>2. Make sure that the ventilation holes are not obstructed.</li> <li>3. Remove any foreign objects from the heatsinks and check for possible dirty heat sink fins.</li> <li>4. Check the fan and clean it.</li> <li>5. Provide enough spacing for adequate ventilation. (See chapter 2)</li> </ol>
LU	<b>Low voltage</b> The AC motor drive detects that the DC bus voltage has fallen below its minimum value.	<ol style="list-style-type: none"> <li>1. Check whether the input voltage falls within the AC motor drive rated input voltage range.</li> <li>2. Check for abnormal load in motor.</li> <li>3. Check for correct wiring of input power to R-S-T (for 3-phase models) without phase loss.</li> </ol>
OL	<b>Overload</b> The AC motor drive detects excessive drive output current. <b>NOTE: The AC motor drive can withstand up to 150% of the rated current for a maximum of 60 seconds.</b>	<ol style="list-style-type: none"> <li>1. Check whether the motor is overloaded.</li> <li>2. Reduce torque compensation setting in Pr.2-03.</li> <li>3. Use the next higher power AC motor drive model.</li> </ol>
OL1	<b>Overload 1</b> Internal electronic overload trip	<ol style="list-style-type: none"> <li>1. Check for possible motor overload.</li> <li>2. Check electronic thermal overload setting.</li> <li>3. Use a higher power motor.</li> <li>4. Reduce the current level so that the drive output current does not exceed the value set by the Motor Rated Current Pr.2-01.</li> </ol>
OL2	<b>Overload 2</b> Motor overload.	<ol style="list-style-type: none"> <li>1. Reduce the motor load.</li> <li>2. Adjust the over-torque detection setting to an appropriate setting (Pr.7-05 to Pr.7-07).</li> </ol>
HPF.1	GFF hardware error	Return to the factory.
HPF.2	CC (current clamp)	
HPF.3	OC hardware error	
HPF.4	OV hardware error	
OCC	<b>Over-current during acceleration</b>	<ol style="list-style-type: none"> <li>1. Short-circuit at motor output: Check for possible poor insulation at the output lines.</li> <li>2. Torque boost too high: Decrease the torque compensation setting in Pr.2-01.</li> <li>3. Acceleration Time too short: Increase the Acceleration Time.</li> <li>4. AC motor drive output power is too small: Replace the AC motor drive with the next higher power model.</li> </ol>

Fault Name	Fault Descriptions	Corrective Actions
OCd	Over-current during deceleration	<ol style="list-style-type: none"> <li>Short-circuit at motor output: Check for possible poor insulation at the output line.</li> <li>Deceleration Time too short: Increase the Deceleration Time.</li> <li>AC motor drive output power is too small: Replace the AC motor drive with the next higher power model.</li> </ol>
OCn	Over-current during constant speed operation	<ol style="list-style-type: none"> <li>Short-circuit at motor output: Check for possible poor insulation at the output line.</li> <li>Sudden increase in motor loading: Check for possible motor stall.</li> <li>AC motor drive output power is too small: Replace the AC motor drive with the next higher power model.</li> </ol>
EF	External Fault	<ol style="list-style-type: none"> <li>Input EF (N.O.) on external terminal is closed to GND. Output U, V, W will be turned off.</li> <li>Give RESET command after fault has been cleared.</li> </ol>
CF1	Internal EEPROM can not be programmed.	Return to the factory.
CF2	Internal EEPROM can not be read.	Return to the factory.
CF33	U-phase error	Return to the factory.
CF34	V-phase error	
CF35	W-phase error	
CF36	OV or LV	
CF37	Current sensor error	
CF38	OH error	
GFF	Ground fault	<p>When (one of) the output terminal(s) is grounded, short circuit current is more than 50% of AC motor drive rated current, the AC motor drive power module may be damaged.</p> <p><b>NOTE: The short circuit protection is provided for AC motor drive protection, not for protection of the user.</b></p> <ol style="list-style-type: none"> <li>Check whether the IGBT power module is damaged.</li> <li>Check for possible poor insulation at the output line.</li> </ol>
cFR	Auto accel/decel failure	<ol style="list-style-type: none"> <li>Check if the motor is suitable for operation by AC motor drive.</li> <li>Check if the regenerative energy is too large.</li> <li>Load may have changed suddenly.</li> </ol>

Fault Name	Fault Descriptions	Corrective Actions
<i>cE--</i>	<b>Communication Error</b>	<ol style="list-style-type: none"> <li>1. Check the RS485 connection between the AC motor drive and RS485 master for loose wires and wiring to correct pins.</li> <li>2. Check if the communication protocol, address, transmission speed, etc. are properly set.</li> <li>3. Use the correct checksum calculation.</li> <li>4. Please refer to group 9 in the chapter 5 for detail information.</li> </ol>
<i>CEE</i>	<b>Software protection failure</b>	Return to the factory.
<i>PcEE</i>	<b>Password is locked.</b>	Keypad will be locked. Turn the power ON after power OFF to re-enter the correct password. See Pr.0-07 and 0-08.
<i>PGEr</i>	<b>PG feedback signal error</b>	<ol style="list-style-type: none"> <li>1. Check parameter settings and signal type of PG feedback (Pr.2-11 to Pr.2-20).</li> <li>2. Check if the wiring of PG is correct.</li> </ol>
<i>PSEr</i>	<b>Limit signal error</b>	<ol style="list-style-type: none"> <li>1. Check if the switch function is correct.</li> <li>2. Check if the wiring is correct.</li> </ol>
<i>doEr</i>	<b>Door open time-out</b>	<ol style="list-style-type: none"> <li>1. Increase "Door Open Time-out Setting" (Pr.3-14).</li> <li>2. Check if the switch function is correct.</li> </ol>
<i>AE</i>	<b>Auto Tuning Error</b>	<ol style="list-style-type: none"> <li>1. Check the cable between drive and motor</li> <li>2. Retry again</li> </ol>

### 6.1.2 Reset

There are three methods to reset the AC motor drive after solving the fault:

1. Press  key on LC-M2E.
2. Set external terminal to "RESET" (set one of Pr.5-00-Pr.5-10 to 15 or 16) and then set to be ON.
3. Send "RESET" command by communication.

#### NOTE

Make sure that RUN command or signal is OFF before executing RESET to prevent damage or personal injury due to immediate operation.

## 6.2 Maintenance and Inspections

Modern AC motor drives are based on solid state electronics technology. Preventive maintenance is required to operate this AC motor drive in its optimal condition, and to ensure a long life. It is recommended to have a check-up of the AC motor drive performed by a qualified technician.

### Daily Inspection:

Basic check-up items to detect if there were any abnormalities during operation are:

1. Whether the motors are operating as expected.
2. Whether the installation environment is abnormal.
3. Whether the cooling system is operating as expected.
4. Whether any irregular vibration or sound occurred during operation.
5. Whether the motors are overheating during operation.
6. Always check the input voltage of the AC drive with a Voltmeter.

### Periodic Inspection:

Before the check-up, always turn off the AC input power and remove the cover. Wait at least 10 minutes after all display lamps have gone out, and then confirm that the capacitors have fully discharged by measuring the voltage between P and N. The voltage between P and N should be less than 25VDC.



- 
1. Disconnect AC power before processing!
  2. Only qualified personnel can install, wire and maintain AC motor drives. Please take off any metal objects, such as watches and rings, before operation. And only insulated tools are allowed.
  3. Never reassemble internal components or wiring.
  4. Prevent electric shocks.



## Periodical Maintenance

## ■ Ambient environment

Check Items	Methods and Criterion	Maintenance Period		
		Daily	Half Year	One Year
Check the ambient temperature, humidity, vibration and see if there are any dust, gas, oil or water drops	Visual inspection and measurement with equipment with standard specification	○		
If there are any dangerous objects	Visual inspection	○		

## ■ Voltage

Check Items	Methods and Criterion	Maintenance Period		
		Daily	Half Year	One Year
Check if the voltage of main circuit and control circuit is correct	Measure with multimeter with standard specification	○		

## ■ Keypad

Check Items	Methods and Criterion	Maintenance Period		
		Daily	Half Year	One Year
Is the display clear for reading	Visual inspection	○		
Any missing characters	Visual inspection	○		

## ■ Mechanical parts

Check Items	Methods and Criterion	Maintenance Period		
		Daily	Half Year	One Year
If there is any abnormal sound or vibration	Visual and aural inspection		○	
If there are any loose screws	Tighten the screws		○	

Check Items	Methods and Criterion	Maintenance Period		
		Daily	Half Year	One Year
If any part is deformed or damaged	Visual inspection		○	
If there is any color change by overheating	Visual inspection		○	
If there is any dust or dirt	Visual inspection		○	

■ Main circuit

Check Items	Methods and Criterion	Maintenance Period		
		Daily	Half Year	One Year
If there are any loose or missing screws	Tighten or replace the screw		○	
If machine or insulator is deformed, cracked, damaged or with color change due to overheating or ageing	Visual inspection <b>NOTE: Please ignore the color change of copper plate</b>		○	
If there is any dust or dirt	Visual inspection		○	

■ Terminals and wiring of main circuit

Check Items	Methods and Criterion	Maintenance Period		
		Daily	Half Year	One Year
If the wiring is color change or deformation due to overheat	Visual inspection		○	
If the insulator of wiring is damaged or color change	Visual inspection		○	
If there is any damage	Visual inspection		○	

■ **DC capacity of main circuit**

Check Items	Methods and Criterion	Maintenance Period		
		Daily	Half Year	One Year
If there is any leak of liquid, color change, crack or deformation	Visual inspection	○		
Measure static capacity when required	Static capacity $\geq$ initial value X 0.85		○	

■ **Resistor of main circuit**

Check Items	Methods and Criterion	Maintenance Period		
		Daily	Half Year	One Year
If there is any peculiar smell or insulator cracks due to overheat	Visual inspection, smell		○	
If there is any disconnection	Visual inspection or measure with multimeter after removing wiring between P ~ N Resistor value should be within $\pm 10\%$		○	

■ **Transformer and reactor of main circuit**

Check Items	Methods and Criterion	Maintenance Period		
		Daily	Half Year	One Year
If there is any abnormal vibration or peculiar smell	Visual, aural inspection and smell		○	

■ **Magnetic contactor and relay of main circuit**

Check Items	Methods and Criterion	Maintenance Period		
		Daily	Half Year	One Year
If there are any loose screws	Visual and aural inspection	○		
If the contact works correctly	Visual inspection	○		

■ **Printed circuit board and connector of main circuit**

Check Items	Methods and Criterion	Maintenance Period		
		Daily	Half Year	One Year
If there are any loose screws and connectors	Tighten the screws and press the connectors firmly in place.		○	
If there is any peculiar smell and color change	Visual inspection		○	
If there is any crack, damage, deformation or corrosion	Visual inspection		○	
If there is any liquid is leaked or deformation in capacity	Visual inspection		○	

■ **Cooling fan of cooling system**

Check Items	Methods and Criterion	Maintenance Period		
		Daily	Half Year	One Year
If there is any abnormal sound or vibration	Visual, aural inspection and turn the fan with hand (turn off the power before operation) to see if it rotates smoothly			○
If there is any loose screw	Tighten the screw			○
If there is any color change due to overheat	Change fan			○

■ **Ventilation channel of cooling system**







Check Items	Methods and Criterion	Maintenance Period		
		Daily	Half Year	One Year
If there is any obstruction in the heat sink, air intake or air outlet	Visual inspection	○		

This page intentionally left blank.

## Appendix A Specifications

Voltage Class		230V Class
Model Number VFD-__ M __ -D		004
Max. Applicable Motor Output (kW)		0.4
Max. Applicable Motor Output (hp)		0.5
Output Rating	Rated Output Capacity (kVA)	1.0
	Rated Output Current (A)	2.5
	Maximum Output Voltage (V)	3-Phase Proportional to Input Voltage
	Output Frequency (Hz)	0.1~400 Hz
	Carrier Frequency (kHz)	1-15
Input Rating	Rated Input Current (A)	Single
		6.3
	Rated Voltage/Frequency	Single/3-phase 200-240 V, 50/60Hz
	Frequency Tolerance	± 5%(47~63 Hz)
Voltage Tolerance		± 10%(180~264 V)
Cooling Method		Fan Cooled
Weight (kg)		2.2
Control Characteristics	Control System	SPWM(Sinusoidal Pulse Width Modulation) control (V/f or sensorless vector control)
	Frequency Setting Resolution	0.01Hz
	Output Frequency Resolution	0.01Hz
	Torque Characteristics	Including the auto-torque, auto-slip compensation; starting torque can be 150% at 1.0Hz
	Overload Endurance	150% of rated current for 1 minute
	Skip Frequency	Three zones, settings range 0.1-400Hz
	Accel/Decel Time	0.1 to 3600 seconds (2 Step settings for Accel/Decel time)
	DC Brake	Operation frequency 0.1-400.0Hz, output 0-100% rated current Start time 0.0-99.9 seconds, stop time 0.0-99.9 seconds
	Regenerated Brake Torque	Approx. 20%(up to 125% possible with option brake resistor externally mounted)
	V/f Pattern	Adjustable V/f pattern

**Appendix A Specifications | VFD-M-D Series**

Voltage Class		230V Class		
Operating Characteristics	Frequency Setting	Keypad	Setting by  	
		External Signal	RS-485 interface; Multi-Function Inputs 1 to 5 (15 steps and Jog)	
	Operation Setting Signal	Keypad	Set by RUN and STOP	
		External Signal	2 wires (Fwd, Rev, RUN), JOG operation, RS-485 serial interface, demo mode	
	Multi-Function Input Signal		Multi-step selection 0 to 5, Jog, first to second accel/decel switches, driver reset, force stop, emergency stop, operation command source, parameter lock, demo mode, open/close limit signal, open allowance signal, force open signal, re-position, 1 <sup>st</sup> /2 <sup>nd</sup> step open/close curve selection	
	Multi-Function Output Indication		AC drive operating, frequency attained, fault indication, driver is ready, overheat alarm, emergency stop, over torque, over voltage, operation mode, alarm indication, demo mode indication, zero speed indication, position detection, limit signal, re-open/close indication, position finished	
Alarm Output Contact		Contact will be On when it malfunctions (1 Form C contact or 1 Form A contact or 2 open collector outputs)		
Operation Functions		AVR, fault records, reverse inhibition, DC brake, auto torque/slip compensation, auto tuning, adjustable carrier frequency, output frequency limits, parameter lock/reset, vector control, PG feedback control, MODBUS communication, abnormal reset, abnormal re-start, fan control, distance control mode 1&2, multi-step control mode 1&2&3, demo mode, door width auto-tuning		
Protection Functions		Over voltage, over current, under voltage, under current, external fault, overload, ground fault, overheating, electronic thermal, PG feedback error, limit signal error, open/close door time-out, re-open/re-close		
Display Keypads		6-key, 4-digit, 7-segment LED, 4 status LEDs, master frequency, output frequency, output current, custom units, parameter values for setup, review and faults, RUN, STOP, RESET, FWD/REV		
Environmental Conditions	Enclosure Rating		IP20	
	Pollution Degree		2	
	Installation Location		Altitude 1,000 m or lower, keep from corrosive gasses, liquid and dust	
	Ambient Temperature		-10°C to 40°C Non-Condensing and not frozen	
	Storage/ Transportation Temperature		-20 °C to 60 °C	
	Ambient Humidity		Below 90% RH (non-condensing)	
	Vibration		9.80665m/s <sup>2</sup> (1G) less than 20Hz, 5.88m/s <sup>2</sup> (0.6G) at 20 to 50Hz	
Approvals		   		



VFD004M21W-D has no approvals.

## Appendix B Accessories

### B.1 All Brake Resistors & Brake Units Used in AC Motor Drives

Note: Please only use DELTA resistors and recommended values. Other resistors and values will void Delta's warranty. Please contact your nearest Delta representative for use of special resistors.

Voltage	Applicable Motor		Full Load Torque Nm	Resistor value spec for each AC Motor Drive	Brake Unit Model VFDB No. of Units Used	Brake Resistors Model and No. of Units Used		Brake Torque 10%ED	Min. Equivalent Resistor Value for each AC Motor Drive
	hp	kW							
230V Series	0.5	0.4	0.216	80W 200Ω	--	BR080W200	1	220	200 Ω



#### NOTE

1. If damage to the drive or other equipment is due to the fact that the brake resistors and the brake modules in use are not provided by Delta, the warranty will be void.
2. Please read the wiring information in the user manual of the brake unit thoroughly prior to installation and operation.
3. Take into consideration the safety of the environment when installing the brake resistors.
4. When using more than 2 brake units, equivalent resistor value of parallel brake unit can't be less than the value in the column "Minimum Equivalent Resistor Value for Each AC Drive" (the right-most column in the table).
5. Please select the factory setting resistance value (Watt) and the duty-cycle value (ED%).
6. Please select the brake unit and/or brake resistor according to the table. "--" means no Delta product. Please use the brake unit according to the Equivalent Resistor Value.
7. If the minimum resistance value is to be utilized, consult local dealers for the calculation of the power in Watt.



8. For safety reasons, install a thermal overload relay between brake unit and brake resistor. Together with the magnetic contactor (MC) in the mains supply circuit to the drive it offers protection in case of any malfunctioning. The purpose of installing the thermal overload relay is to protect the brake resistor against damage due to frequent brake or in case the brake unit is continuously on due to unusual high input voltage. Under these circumstances the thermal overload relay switches off the power to the drive. Never let the thermal overload relay switch off only the brake resistor as this will cause serious damage to the AC Motor Drive.

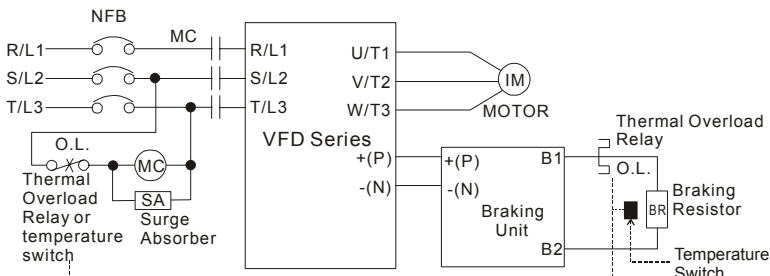

Note1: When using the AC drive with DC reactor, please refer to wiring diagram in the AC drive user manual for the wiring of terminal + (P) of Braking unit.

Note2: **Do NOT** wire terminal - (N) to the neutral point of power system.

## B.1.1 Dimensions and Weights for Brake Resistors

(Dimensions are in millimeter)

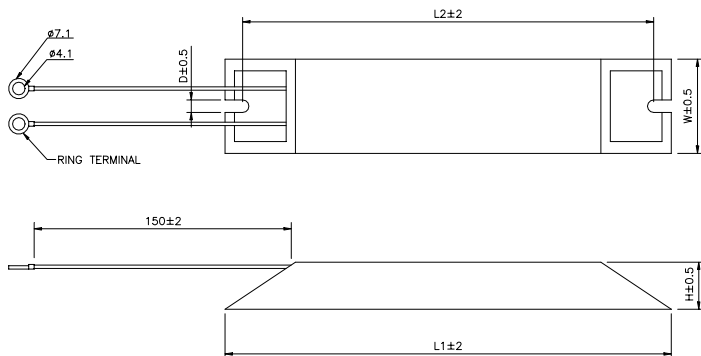

TYPE	L1	L2	H	D	W	MAX. WEIGHT(g)
BR080W200	140	125	20	5.3	60	160

## B.2 Non-fuse Circuit Breaker Chart

The fuse should comply with UL248 and the breaker should comply with UL489.

The current rating of the breaker shall be within 2~4 times maximum input current rating.

(Refer to Appendix A for rated input/output current)

1-phase	
Model	Recommended non-fuse breaker (A)
VFD004M21B-D	6.3
VFD004M21W-D	6.3

## B.3 Fuse Specification Chart

Smaller fuses than those shown in the table are permitted.

Model	I (A) Input	I (A) Output	Line Fuse	
			I (A)	Bussmann P/N
VFD004M21B-D	6.3	2.5	15	JJN-15
VFD004M21W-D	6.3	2.5	15	JJN-15

## B.4 Reactor

### B.4.1 AC Reactor

#### AC Input Reactor Recommended Value

230V, 50/60Hz, 1-Phase

kW	HP	Fundamental Amps	Max. continuous Amps	Inductance (mH)
				3~5% impedance
0.4	0.5	5	7.5	3

#### AC Output Reactor Recommended Value

230V, 50/60Hz, 3-Phase

kW	HP	Fundamental Amps	Max. continuous Amps	Inductance (mH)	
				3% impedance	5% impedance
0.4	0.5	4	6	6.5	9

### Applications for AC Reactor

#### Connected in input circuit

Application 1	Question
When more than one AC motor drive is connected to the same power, one of them is ON during operation.	When applying to one of the AC motor drive, the charge current of capacity may cause voltage ripple. The AC motor drive may damage when over current occurs during operation.

#### Correct wiring

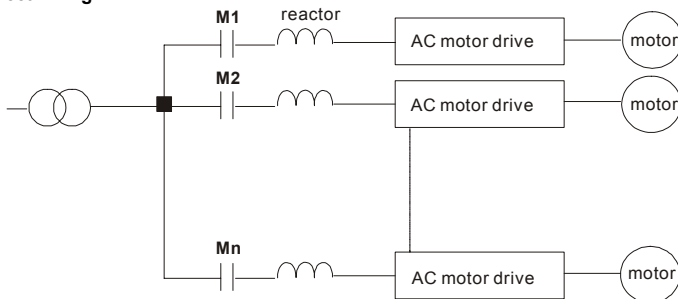

Application 2	Question
Silicon rectifier and AC motor drive is connected to the same power.	Surges will be generated at the instant of silicon rectifier switching on/off. These surges may damage the mains circuit.

**Correct wiring**

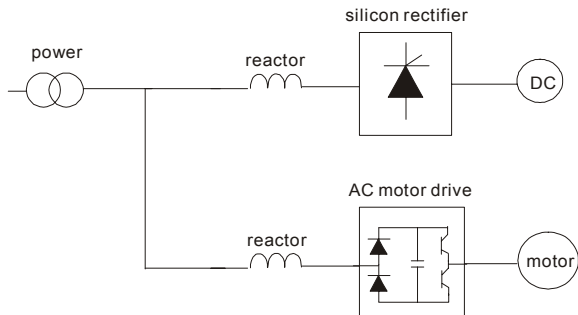

Application 3	Question
Used to improve the input power factor, to reduce harmonics and provide protection from AC line disturbances- (surges, switching spikes, short interruptions, etc.). AC line reactor should be installed when the power supply capacity is 500kVA or more and exceeds 6 times the inverter capacity, or the mains wiring distance $\leq 10m$ .	When power capacity is too large, line impedance will be small and the charge current will be too large. That may damage AC motor drive due to higher rectifier temperature.

**Correct wiring**

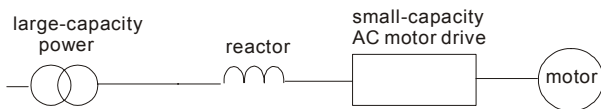

## B.4.2 Zero Phase Reactor (RF220X00A)

Dimensions are in millimeter and (inch)

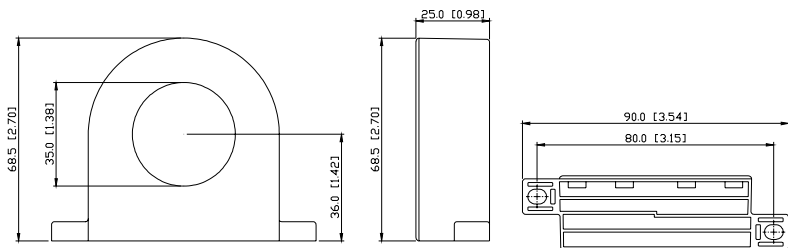

Cable type (Note)	Recommended Wire Size (mm <sup>2</sup> )			Qty.	Wiring Method
	AWG	mm <sup>2</sup>	Nominal (mm <sup>2</sup> )		
Single-core	≤ 10	≤ 5.3	≤ 5.5	1	Diagram A
	≤ 2	≤ 33.6	≤ 38	4	Diagram B
Three-core	≤ 12	≤ 3.3	≤ 3.5	1	Diagram A
	≤ 1	≤ 42.4	≤ 50	4	Diagram B

**Note:** 600V Insulated unshielded Cable.

### Diagram B

Please put all wires through 4 cores in series without winding.

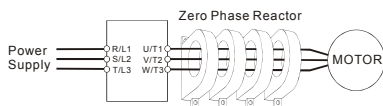

**Note 1:** The table above gives approximate wire size for the zero phase reactors but the selection is ultimately governed by the type and diameter of cable fitted i.e. the cable must fit through the center hole of zero phase reactors.

**Note 2:** Only the phase conductors should pass through, not the earth core or screen.

**Note 3:** When long motor output cables are used an output zero phase reactor may be required to reduce radiated emissions from the cable.

### Diagram A

Please wind each wire 4 times around the core. The reactor must be put at inverter output as close as possible.

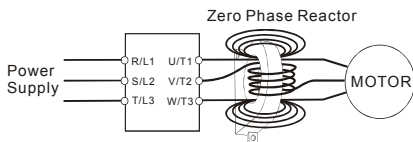





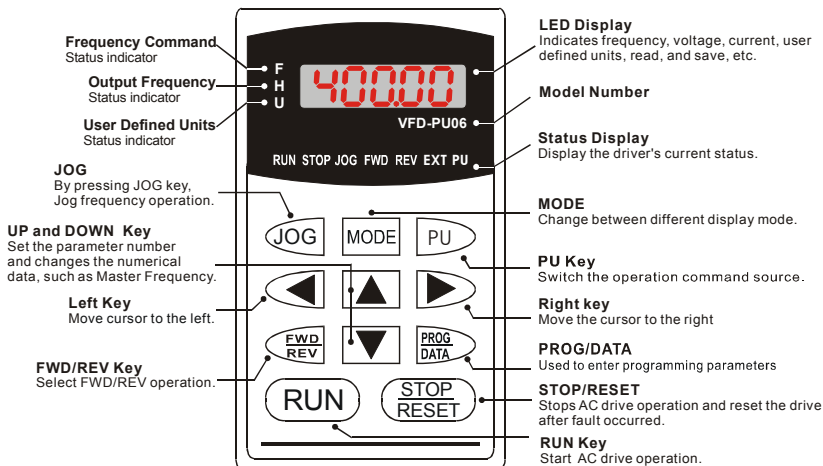



## B.5 VFD-PU06

### B.5.1 Description of the Digital keypad VFD-PU06



### B.5.2 Explanation of Display Message

Display Message	Descriptions
	The AC motor drive Master Frequency Command.
	The Actual Operation Frequency present at terminals U, V, and W.
	The custom unit (u)
	The output current present at terminals U, V, and W.
	Press  to change the mode to READ. Press PROG/DATA for about 2 sec or until it's flashing, read the parameters of AC drive to the digital keypad PU06. It can read 4 groups of parameters to PU06. (read 0 - read 3)
	Press  to change the mode to SAVE. Press PROG/DATA for about 2 sec or until it's flashing, then write the parameters from the digital keypad PU06 to AC drive. If it has saved, it will show the type of AC motor drive.

Display Message	Descriptions
	The specified parameter setting.
	The actual value stored in the specified parameter.
	External Fault
	"End" displays for approximately 1 second if the entered input data have been accepted. After a parameter value has been set, the new value is automatically stored in memory. To modify an entry, use the  or  keys.
	"Err" displays if the input is invalid.
	Communication Error. Please check the AC motor drive user manual (Chapter 5, Group 9 Communication Parameter) for more details.

### B.5.3 VFD-PU06 Operation Flow Chart

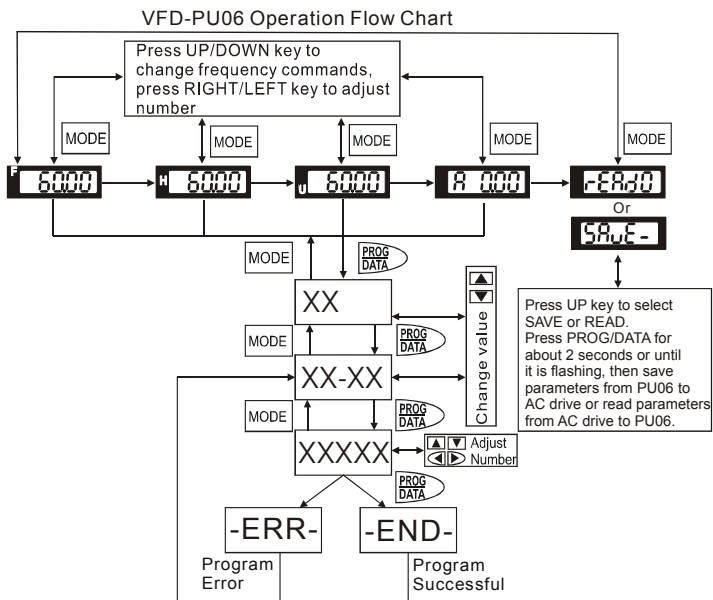

## B.6 AMD - EMI Filter Cross Reference

The EMI Filter for VFD004M21B-D, VFD004M21W-D is RF015M21AA.

### **Installation**

All electrical equipment, including AC motor drives, will generate high-frequency/low-frequency noise and will interfere with peripheral equipment by radiation or conduction when in operation. By using an EMI filter with correct installation, much interference can be eliminated. It is recommended to use DELTA EMI filter to have the best interference elimination performance.

We assure that it can comply with following rules when AC motor drive and EMI filter are installed and wired according to user manual:

- **EN61000-6-4**
- **EN61800-3: 1996 + A11: 2000**
- **EN55011 (1991) Class A Group 1 (1<sup>st</sup> Environment, restricted distribution)**

### **General precaution**

1. EMI filter and AC motor drive should be installed on the same metal plate.
2. Please install AC motor drive on footprint EMI filter or install EMI filter as close as possible to the AC motor drive.
3. Please wire as short as possible.
4. Metal plate should be grounded.
5. The cover of EMI filter and AC motor drive or grounding should be fixed on the metal plate and the contact area should be as large as possible.

### **Choose suitable motor cable and precautions**

Improper installation and choice of motor cable will affect the performance of EMI filter. Be sure to observe the following precautions when selecting motor cable.

1. Use the cable with shielding (double shielding is the best).
2. The shielding on both ends of the motor cable should be grounded with the minimum length and maximum contact area.
3. Remove any paint on metal saddle for good ground contact with the plate and shielding.



## Appendix B Accessories | VFD-M-D Series

Remove any paint on metal saddle for good ground contact with the plate and shielding.

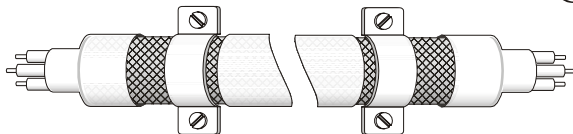
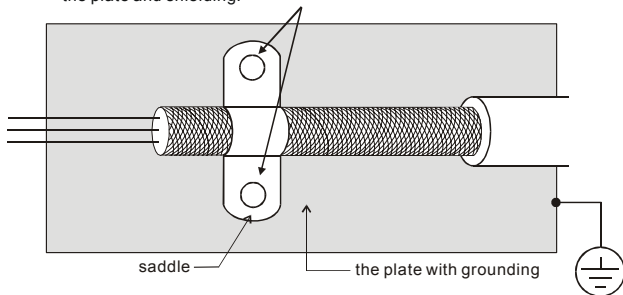

Saddle on both ends

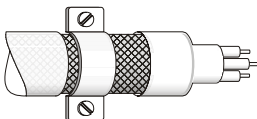

Saddle on one end

### **The length of motor cable**

When motor is driven by an AC motor drive of PWM type, the motor terminals will experience surge voltages easily due to components conversion of AC motor drive and cable capacitance. When the motor cable is very long (especially for the 460V series), surge voltages may reduce insulation quality. To prevent this situation, please follow the rules below:

- Use a motor with enhanced insulation.
- Connect an output reactor (optional) to the output terminals of the AC motor drive
- The length of the cable between AC motor drive and motor should be as short as possible (10 to 20 m or less)

- For models 5hp/3.7kW and less:

Insulation level of motor	1000V	1300V	1600V
460VAC input voltage	66 ft (20m)	165 ft (50m)	165 ft (50m)
230VAC input voltage	328 ft (100m)	328 ft (100m)	328 ft (100m)

**NOTE**

When a thermal O/L relay protected by motor is used between AC motor drive and motor, it may malfunction (especially for 460V series), even if the length of motor cable is only 165 ft (50m) or less. To prevent it, please use AC reactor and/or lower the carrier frequency (Pr. 02-03 PWM carrier frequency).

**NOTE**

Never connect phase lead capacitors or surge absorbers to the output terminals of the AC motor drive.

- If the length is too long, the stray capacitance between cables will increase and may cause leakage current. It will activate the protection of over current, increase leakage current or not insure the correction of current display. The worst case is that AC motor drive may damage.
- If more than one motor is connected to the AC motor drive, the total wiring length is the sum of the wiring length from AC motor drive to each motor.

## B.6.1 Dimensions

Dimensions are in millimeter and (inch)

Order P/N: RF015M21AA

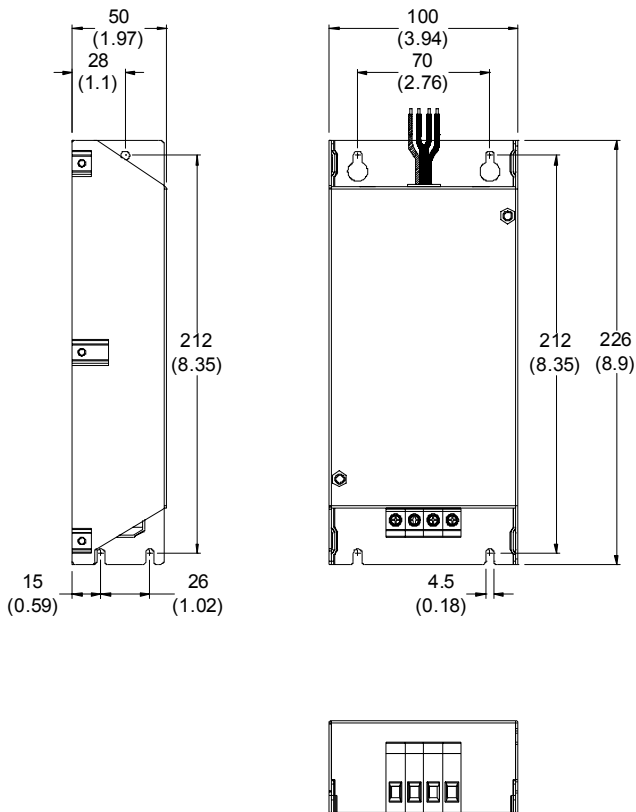

## Appendix C How to Select the Right AC Motor Drive

The choice of the right AC motor drive for the application is very important and has great influence on its lifetime. If the capacity of AC motor drive is too large, it cannot offer complete protection to the motor and motor maybe damaged. If the capacity of AC motor drive is too small, it cannot offer the required performance and the AC motor drive maybe damaged due to overloading.

But by simply selecting the AC motor drive of the same capacity as the motor, user application requirements cannot be met completely. Therefore, a designer should consider all the conditions, including load type, load speed, load characteristic, operation method, rated output, rated speed, power and the change of load capacity. The following table lists the factors you need to consider, depending on your requirements.

Item		Related Specification			
		Speed and torque characteristics	Time ratings	Overload capacity	Starting torque
Load type	Friction load and weight load Liquid (viscous) load Inertia load Load with power transmission	●			●
Load speed and torque characteristics	Constant torque Constant output Decreasing torque Decreasing output	●	●		
Load characteristics	Constant load Shock load Repetitive load High starting torque Low starting torque	●	●	●	●
Continuous operation, Short-time operation Long-time operation at medium/low speeds			●	●	
Maximum output current (instantaneous) Constant output current (continuous)		●		●	
Maximum frequency, Base frequency		●			
Power supply transformer capacity or percentage impedance Voltage fluctuations and unbalance Number of phases, single phase protection Frequency				●	●
Mechanical friction, losses in wiring				●	●
Duty cycle modification			●		

## C.1 Capacity Formulas

### 1. When one AC motor drive operates one motor

The starting capacity should be less than 1.5x rated capacity of AC motor drive

The starting capacity=

$$\frac{k \times N}{973 \times \eta \times \cos \varphi} \left( T_L + \frac{GD^2}{375} \times \frac{N}{t_A} \right) \leq 1.5 \times \text{the\_capacity\_of\_AC\_motor\_drive}(kVA)$$

### 2. When one AC motor drive operates more than one motor

2.1 The starting capacity should be less than the rated capacity of AC motor drive

- Acceleration time  $\leq 60$  seconds

The starting capacity=

$$\frac{k \times N}{\eta \times \cos \varphi} [n_r + n_s(k_s - 1)] = P_{Cl} \left[ 1 + \frac{n_s}{n_r} (k_s - 1) \right] \leq 1.5 \times \text{the\_capacity\_of\_AC\_motor\_drive}(kVA)$$

- Acceleration time  $\geq 60$  seconds

The starting capacity=

$$\frac{k \times N}{\eta \times \cos \varphi} [n_r + n_s(k_s - 1)] = P_{Cl} \left[ 1 + \frac{n_s}{n_r} (k_s - 1) \right] \leq \text{the\_capacity\_of\_AC\_motor\_drive}(kVA)$$

2.2 The current should be less than the rated current of AC motor drive(A)

- Acceleration time  $\leq 60$  seconds

$$n_r + I_M \left[ 1 + \frac{n_s}{n_r} (k_s - 1) \right] \leq 1.5 \times \text{the\_rated\_current\_of\_AC\_motor\_drive}(A)$$

- Acceleration time  $\geq 60$  seconds

$$n_r + I_M \left[ 1 + \frac{n_s}{n_r} (k_s - 1) \right] \leq \text{the\_rated\_current\_of\_AC\_motor\_drive}(A)$$

2.3 When it is running continuously

- The *requirement* of load capacity should be less than the capacity of AC motor drive(kVA)

The requirement of load capacity=

$$\frac{k \times P_M}{\eta \times \cos \varphi} \leq \text{the\_capacity\_of\_AC\_motor\_drive}(kVA)$$

- The motor capacity should be less than the capacity of AC motor drive

$$k \times \sqrt{3} \times V_M \times I_M \times 10^{-3} \leq \text{the\_capacity\_of\_AC\_motor\_drive}(kVA)$$

- The current should be less than the rated current of AC motor drive(A)

$$k \times I_M \leq \text{the\_rated\_current\_of\_AC\_motor\_drive}(A)$$

**Symbol explanation**

$P_M$  : Motor shaft output for load (kW)

$\eta$  : Motor efficiency (normally, approx. 0.85)

$\cos \varphi$  : Motor power factor (normally, approx. 0.75)

$V_M$  : Motor rated voltage(V)

$I_M$  : Motor rated current(A), for commercial power

$k$  : Correction factor calculated from current distortion factor (1.05 - 1.1, depending on PWM method)

$P_{C1}$  : Continuous motor capacity (kVA)

$k_S$  : Starting current/rated current of motor

$n_T$  : Number of motors in parallel

$n_S$  : Number of simultaneously started motors

$GD^2$  : Total inertia ( $GD^2$ ) calculated back to motor shaft (kg m<sup>2</sup>)

$T_L$  : Load torque

$t_A$  : Motor acceleration time

N : Motor speed

## C.2 General Precaution

### Selection Note

1. When the AC Motor Drive is connected directly to a large-capacity power transformer (600kVA or above) or when a phase lead capacitor is switched, excess peak currents may occur in the power input circuit and the converter section may be damaged. To avoid this, use an AC input reactor (optional) before AC Motor Drive mains input to reduce the current and improve the input power efficiency.
2. When a special motor is used or more than one motor is driven in parallel with a single AC Motor Drive, select the AC Motor Drive current  $\geq 1.25 \times$  (Sum of the motor rated currents).
3. The starting and accel./decel. characteristics of a motor are limited by the rated current and the overload protection of the AC Motor Drive. Compared to running the motor D.O.L. (Direct On-Line), a lower starting torque output with AC Motor Drive can be expected. If higher starting torque is required (such as for elevators, mixers, tooling machines, etc.) use an AC Motor Drive of higher capacity or increase the capacities for both the motor and the AC Motor Drive.
4. When an error occurs on the drive, a protective circuit will be activated and the AC Motor Drive output is turned off. Then the motor will coast to stop. For an emergency stop, an external mechanical brake is needed to quickly stop the motor.

### Parameter Settings Note

1. The AC Motor Drive can be driven at an output frequency up to 400Hz (less for some models) with the digital keypad. Setting errors may create a dangerous situation. For safety, the use of the upper limit frequency function is strongly recommended.
2. High DC brake operating voltages and long operation time (at low frequencies) may cause overheating of the motor. In that case, forced external motor cooling is recommended.
3. Motor accel./decel. time is determined by motor rated torque, load torque, and load inertia.

- If the stall prevention function is activated, the accel./decel. time is automatically extended to a length that the AC Motor Drive can handle. If the motor needs to decelerate within a certain time with high load inertia that can't be handled by the AC Motor Drive in the required time, either use an external brake resistor and/or brake unit, depending on the model, (to shorten deceleration time only) or increase the capacity for both the motor and the AC Motor Drive.

### C.3 How to Choose a Suitable Motor

#### Standard motor

When using the AC Motor Drive to operate a standard 3-phase induction motor, take the following precautions:

- The energy loss is greater than for an inverter duty motor.
- Avoid running motor at low speed for a long time. Under this condition, the motor temperature may rise above the motor rating due to limited airflow produced by the motor's fan. Consider external forced motor cooling.
- When the standard motor operates at low speed for long time, the output load must be decreased.
- The load tolerance of a standard motor is as follows:

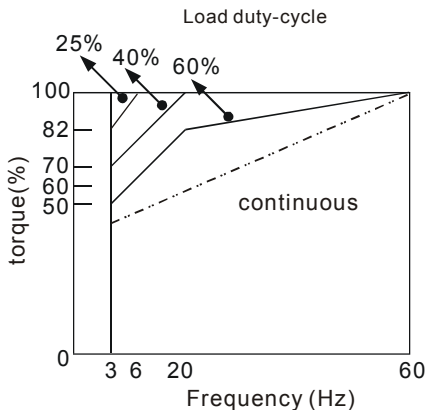



### **Appendix C How to Select the Right AC Motor Drive | VFD-M-D Series**

5. If 100% continuous torque is required at low speed, it may be necessary to use a special inverter duty motor.
6. Motor dynamic balance and rotor endurance should be considered once the operating speed exceeds the rated speed (60Hz) of a standard motor.
7. Motor torque characteristics vary when an AC Motor Drive instead of commercial power supply drives the motor. Check the load torque characteristics of the machine to be connected.
8. Because of the high carrier frequency PWM control of the VFD series, pay attention to the following motor vibration problems:
  - Resonant mechanical vibration: anti-vibration (damping) rubbers should be used to mount equipment that runs at varying speed.
  - Motor imbalance: special care is required for operation at 50 or 60 Hz and higher frequency.
  - To avoid resonances, use the Skip frequencies.
9. The motor fan will be very noisy when the motor speed exceeds 50 or 60Hz.

#### **Special motors:**

1. Pole-changing (Dahlander) motor:

The rated current is differs from that of a standard motor. Please check before operation and select the capacity of the AC motor drive carefully. When changing the pole number the motor needs to be stopped first. If over current occurs during operation or regenerative voltage is too high, please let the motor free run to stop (coast).
2. Submersible motor:

The rated current is higher than that of a standard motor. Please check before operation and choose the capacity of the AC motor drive carefully. With long motor cable between AC motor drive and motor, available motor torque is reduced.
3. Explosion-proof (Ex) motor:

Needs to be installed in a safe place and the wiring should comply with the (Ex) requirements. Delta AC Motor Drives are not suitable for (Ex) areas with special precautions.

4. Gear reduction motor:

The lubricating method of reduction gearbox and speed range for continuous operation will be different and depending on brand. The lubricating function for operating long time at low speed and for high-speed operation needs to be considered carefully.

5. Synchronous motor:

The rated current and starting current are higher than for standard motors. Please check before operation and choose the capacity of the AC motor drive carefully. When the AC motor drive operates more than one motor, please pay attention to starting and changing the motor.

**Power Transmission Mechanism**

Pay attention to reduced lubrication when operating gear reduction motors, gearboxes, belts and chains, etc. over longer periods at low speeds. At high speeds of 50/60Hz and above, lifetime reducing noises and vibrations may occur.

**Motor torque**

The torque characteristics of a motor operated by an AC motor drive and commercial mains power are different.

Below you'll find the torque-speed characteristics of a standard motor (4-pole, 15kW):

