



DELTA ELECTRONICS, INC.
www.delta.com.tw/industrialautomation

IABU Headquarters

Delta Electronics, Inc.

Taoyuan

31-1, Xingbang Road, Guishan Industrial Zone,
Taoyuan County 33370, Taiwan, R.O.C.
TEL: 886-3-362-6301 / FAX: 886-3-362-7267

Asia

Delta Electronics (Jiang Su) Ltd.

Wujiang Plant3

1688 Jiangxing East Road,
Wujiang Economy Development Zone,
Wujiang City, Jiang Su Province,
People's Republic of China (Post code: 215200)
TEL: 86-512-6340-3008 / FAX: 86-512-6340-7290

Delta Greentech (China) Co., Ltd.

238 Min-Xia Road, Cao-Lu Industry Zone, Pudong, Shanghai,
People's Republic of China
Post code : 201209
TEL: 021-58635678 / FAX: 021-58630003

Delta Electronics (Japan), Inc.

Tokyo Office

Delta Shibadaimon Building, 2-1-14
Shibadaimon, Minato-Ku, Tokyo, 105-0012,
Japan
TEL: 81-3-5733-1111 / FAX: 81-3-5733-1211

Delta Electronics (Korea), Inc.

234-9, Duck Soo Building 7F, Nonhyun-Dong,
Kangnam-Gu, Seoul, Korea 135-010
TEL: 82-2-515-5305 / FAX: 82-2-515-5302

Delta Electronics (Singapore) Pte. Ltd.

8 Kaki Bukit Road 2, #04-18 Ruby Warehouse Complex,
Singapore 417841
TEL: 65-6747-5155 / FAX: 65-6744-9228

Delta Power Solutions (India) Pte. Ltd.

Plot No. 28, Sector-34, EHTP
Gurgaon-122001 Haryana, India
TEL: 91-124-416-9040 / FAX: 91-124-403-6045

America

Delta Products Corporation (USA)

Raleigh Office

P.O. Box 12173, 5101 Davis Drive,
Research Triangle Park, NC 27709, U.S.A.
TEL: 1-919-767-3813 / FAX: 1-919-767-3969

Delta Greentech (Brasil) S/A

Sao Paulo Office

Rua Itapeva, N° 26, 3° andar, Bela vista
ZIP: 01332-000 - São Paulo - SP - Brasil
TEL : 55-11-3568-3875 / FAX : 55-11-3568-3865

Europe

Deltronics (The Netherlands) B.V.

Eindhoven Office

De Witbogt 15, 5652 AG Eindhoven, The Netherlands
TEL: 31-40-2592850 / FAX: 31-40-2592851

*We reserve the right to change the information in this catalogue without prior notice



VFD-VE

FOC+PG Control AC Motor Drivers



VFD-VE

FOC+PG Control AC Motor Drivers



Features

- V/F, FOC+PG, SVC, Torque+PG, Position control
- PG close-loop control, speed control range 1:1000
- Built-in PID feedback control
- Motor parameter and load inertia auto-tuning
- 4 independent S-curve/accel/decel time setting
- Mechanical braking release control function
- Deceleration energy braking function
- Motor Y-▲ switch control
- 10 communication address for block transfer
- I/O serial pulse position control
- Monitor card and software
- Auto energy saving at light load
- Motor overheat protection (PTC function)
- PI gain for zero/low/high speed and bandwidth setting
- Home search, Pulse command and 16 point position control

The Exterior and Characteristics of the Drive

Best with:

- Transmission devices
- Elevators
- Crane
- CNC machine center
- Extrusion molding
- Injection molding
- Auto storage system



The digital operation panel could be extended for 20 meters externally

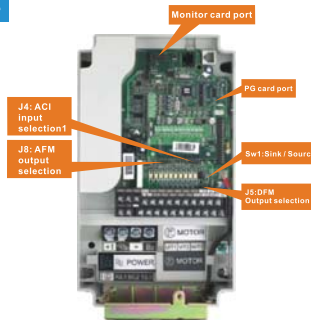

Could connect with PG to serve as the closed-circuit speed control

KPV-CE01 Digital Keypad Description

<p>Frequency Command Status Indicator</p> <p>Output Frequency Status Indicator</p> <p>User-Select Contents Status Indicator</p> <p>JOG Operation Key Press this key to execute the JOG frequency operation</p> <p>Left Key Could easily modify settings of greater values</p> <p>Value Modification Key Could be used to modify settings and parameters</p> <p>FWD/REV Direction Key</p> <p>RUN Key Enable the drive to start operating</p>		<p>LED Display Display frequency, current, voltage and error, etc.</p> <p>Serial Number</p> <p>Status Display Display the drive's current status</p> <p>Mode Selection Key Press this key repetitively to select the mode of the users' desire</p> <p>PU Key Could easily modify settings of smaller values</p> <p>Right Key</p> <p>PROG/DATA Key Could be used to read all the parameter settings that are utilized in modifying the drive</p> <p>STOP/RESET Key Enable the drive to stop and to reset</p>
---	--	---

Basic Wiring Diagram

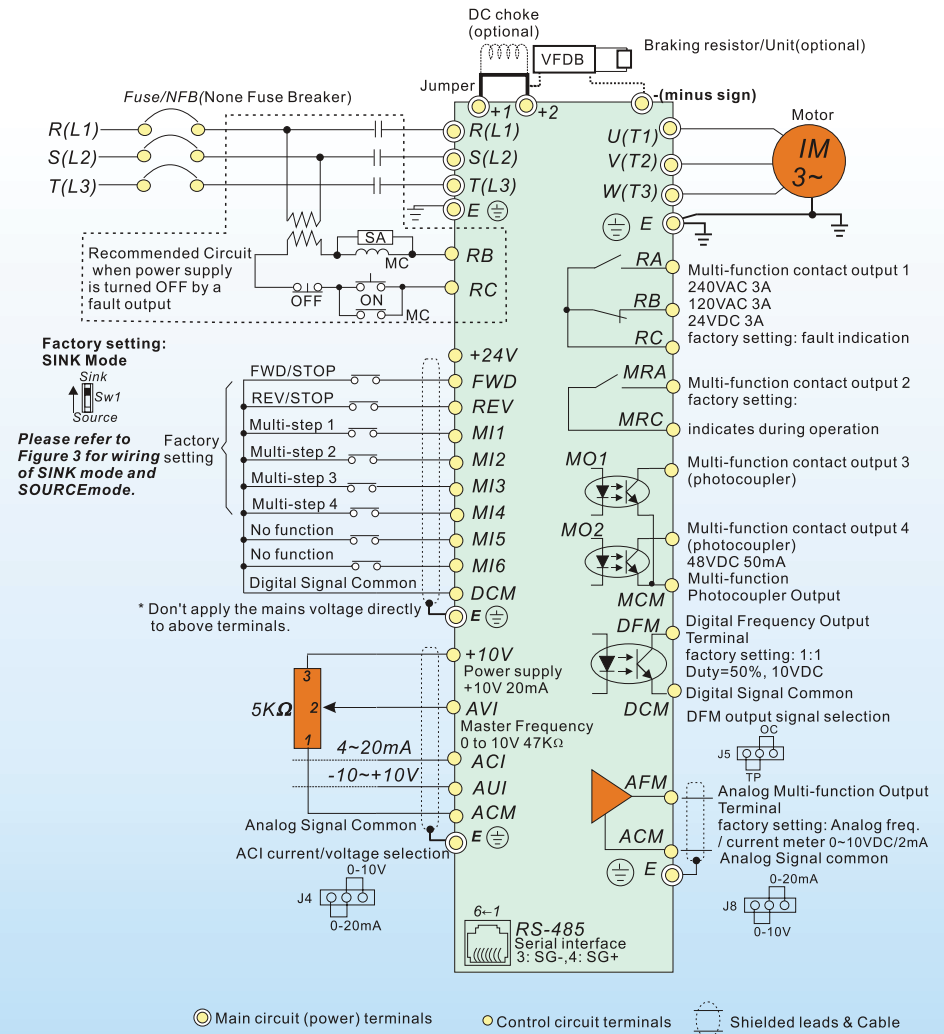

○ Main circuit (power) terminals ● Control circuit terminals ⊞ Shielded leads & Cable

FOC+PG Control AC Motor Drivers



Model Explanation

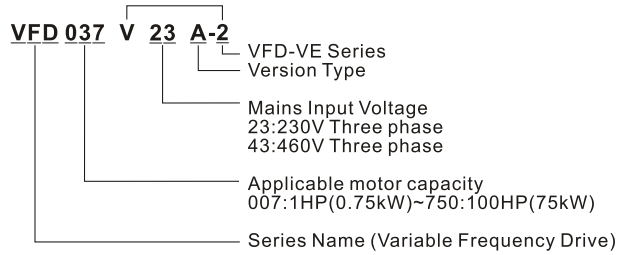

Specifications

230V Series

Voltage Class		230V Class											
Model Number VFD-XXXV		007	015	022	037	055	075	110	185	220	220	300	370
Output Rating	Rated Output Capacity (kVA)	1.9	2.7	4.2	6.5	9.5	13	19	29	34	34	46	55
	Rated Output Current for Constant Torque (A)	5.0	7.5	11	17	25	33	49	75	90	90	120	146
	Max. Applicable Motor Output (HP)	1.0	2.0	3.0	5.0	7.5	10	15	25	30	30	40	50
	Rated Output Current for Variable Torque (A)	6.25	9.4	13	21	31	41	61	93	112	112	150	182
	Max. Applicable Motor Output (HP)	1.5	2.5	4	7.5	10	15	20	30	40	40	50	60
Maximum Output Voltage (V)		3-Phase Proportional to Input Voltage											
Output Frequency (Hz)		0.00~600.00 Hz											
Input Rating	Rated Input Current (A)	6.4	9.9	15	21	25	33	52	63	68	79	106	126
	Rated Voltage/Frequency	3-phase, 200-240V, 50/60Hz											
	Voltage Tolerance	± 10%(180~264 V)											
	Frequency Tolerance	± 5%(47~63 Hz)											
Cooling Method		Fan Cooled											
Weight (kg)		2.7	3.2	4.5	6.8	8	10	13	13	13	13	36	36

460V Series

Voltage Class		460V Class														
Model Number VFD-XXXV		007	015	022	037	055	075	110	150	185	220	300	370	450	550	750
Output Rating	Rated Output Capacity (kVA)	2.3	3.2	4.2	6.3	9.9	14	18	24	29	34	46	56	69	80	100
	Rated Output Current for Constant Torque (A)	3.0	4.2	6.0	8.5	13	18	24	32	38	45	60	73	91	110	150
	Max. Applicable Motor Output (HP)	1.0	2.0	3.0	5.0	7.5	10	15	20	25	30	40	50	60	75	100
	Rated Output Current for Variable Torque (A)	3.8	5.3	7.5	10	16	22	30	40	47	56	75	91	113	138	188
	Max. Applicable Motor Output (HP)	1.5	2.5	4	7.5	10	15	20	25	30	40	50	60	75	100	125
Maximum Output Voltage (V)		3-phase Proportional to Input Voltage														
Output Frequency (Hz)		0.00~600.00 Hz														
Input Rating	Rated Input Current (A)	3-phase 380~480V														
	Rated Voltage	3-phase, 380 to 480V														
	Voltage Tolerance	± 10%(342~528V)														
	Frequency Tolerance	± 5%(47~63 Hz)														
Cooling Method		Fan Cooled														
Weight (kg)		2.7	3.2	4.5	6.8	8	10	13	13	13	13	36	36	36	50	50

General Specifications

Control Characteristics	Control Systems	SPWM(Sinusoidal Pulse Width Modulation) 1 V/f curve; 2 V/f+PG; 3 SVC; 4 FOC+PG; 5 TQR+PG	
	Torque Start-Up	Starting torque is 150% at 0.5Hz and 0 Hz (with FOC+PG Control mode)	
	Speed Control Range	1:100 (could reach 1:1000 when using with PG)	
	Speed Control Accuracy	± 0.5% (could reach 0.02% when using with PG)	
	Speed Respond Ability	5Hz (FOC+PG control reaching 40Hz)	
	Maximum Output Frequency (Hz)	0.00 to 600.00 Hz	
	Output Frequency Accuracy	Digital command: ± 0.005%, analog command: ± 0.5%	
	Frequency Setting Resolution	Digital command: 0.01Hz, analog command: 1/1000 (10bit) of the maximum output frequency	
	Torque Limit	200% torque current as the maximum	
	Torque Accuracy	± 8%	
	Accel/Decel Time	0.00~600.00/0.0~6000.0 second	
	V/f Curve	The 4-point desired V/f curve & the square curve	
	Protection Characteristics	Frequency Setting Signal	+10V, ±10V, 0~20mA/4~20mA, Keypad, RS-485 interface, Multi-function Inputs (15 steps, up/down)
Braking Torque		About 20%	
Motor Protection		Electronic thermal relay protection	
Over-current Protection		Current control: 220% over-current protection; 300% rated current	
Ground Leakage Current Protection		50% rated current	
Overload Ability		Constant/Variable Torque: 150% for 60 seconds; 200% for 2 seconds	
Voltage Protection		Over-voltage level: Vdc>400/800 V Low-voltage level: Vdc<200/400 V	
Input Power Over-Voltage Protection		Varistor (MOV)	
Overheat Protection		Built-in temperature sensor	
Momentary Power Loss Compensation		The setting could be as long as 5 seconds	
Environment		Protection Level	NEMA 1/IP20
		Operation Temperature	-10°C to 40°C for 15hp and above & -10°C to 50°C for 10hp and below
		Storage Temperature	-20°C~60°C
	Humidity	Below 90% RH (non-condensing)	
	Vibration	If it is below 20Hz, it is 1.0G; if between 20~60 Hz, it is then 0.6G	
	Cooling System	Forced cooling	
	Installation Location	If under 1,000m, be advised to stay from corrosive gases, liquid and dust	
Approvals			



Dimensions

unit:mm

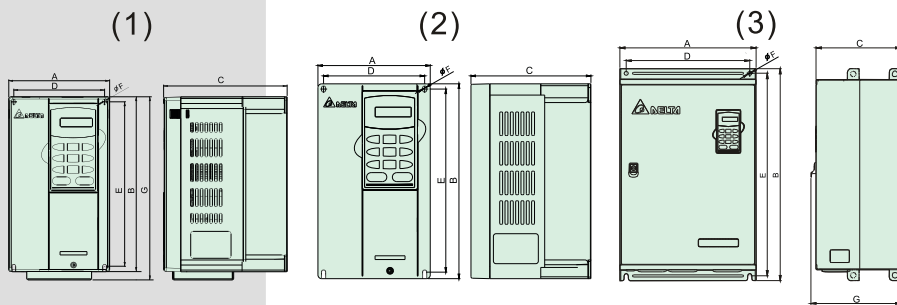

	Model Name	A	B	C	D	E	F	G
(1)	VFD037V23A/ 43A-2	150.0 [6.91]	260.0 [10.24]	183.7 [7.24]	135.0 [5.32]	244.3 [9.63]	6.5 [0.26]	272.1 [10.72]
(2)	007V23A/43A-2, 015V23A/43A-2, 022V23A/43A-2	150.0 [5.91]	260.0 [10.24]	160.2 [6.31]	135.0 [5.32]	244.3 [9.63]	6.5 [0.26]	
	055V23A/43A-2, 075V23A/43A-2, 110V43B-2	200.0 [7.88]	323.0 [12.72]	183.2 [7.22]	185.6 [7.31]	303.0 [11.93]	7.0 [0.28]	
(3)	110V23A/43A-2, 150V23A/43A-2, 185V23A/43A-2, 220V23A/43A-2	250.0 [9.84]	403.0 [15.9]	250.4 [8.08]	226.0 [8.90]	384.0 [15.12]	10.0 [0.39]	
	300V23A-2, 370V23A-2, 550V43C-2, 750V43C-2	370.0 [14.57]	595.0 [23.43]	260.0 [10.24]	335.0 [13.19]	560.0 [22.05]	13.0 [0.51]	-
	300V43A-2, 370V43A-2, 450V43A-2	370.0 [14.57]	589.0 [23.19]	260.0 [10.24]	335.0 [13.19]	560.0 [22.06]	13.0 [0.51]	-

*We reserve the right of this catalogue contained information change without prior notice.

VFD-VE with 100% sudden load

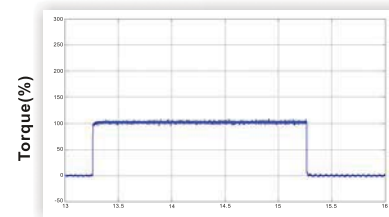
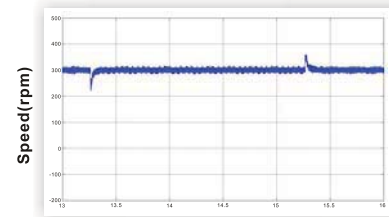

PDFF Function

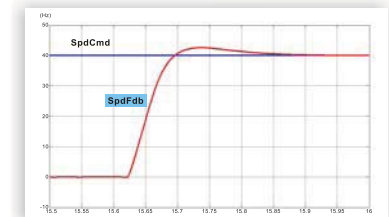

Without PDFF function

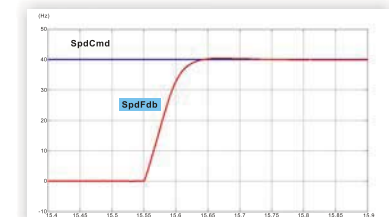

With PDFF function

Accessories (Optional)



VFDB Series Braking Unit



EMI FILTER



BR-Series Braking resistor



EMV-PG01X CARD



EMV-PG01O CARD



EMV-PG01L CARD

Voltage	Applicable Motor Output(kW)															
	007	015	022	037	055	075	110	150	185	220	300	370	450	550	750	
3-Phase 230V 180~265Vac	B Frame		C Frame		D Frame			E1 Frame								
	Braking transistor built-in				DC-Reactor built-in											
3-Phase 460V 340~510Vac	B Frame		C Frame		D Frame			E Frame		E1 Frame						
	Braking transistor built-in				DC-Reactor built-in											