

適用馬達尺寸 / COMPATIBLE MOTOR DIMENSIONS

A	B	C	D	E	F	H	L
≤24	95	≤51.8	≤9	115	8.1~10	90~110	≥C-10

※馬達出力軸小於24時,附襯套
 BUSHING WILL BE SUPPLIED WHEN THE MOTOR
 SHAFT DIAMETER IS SMALLER THAN 24

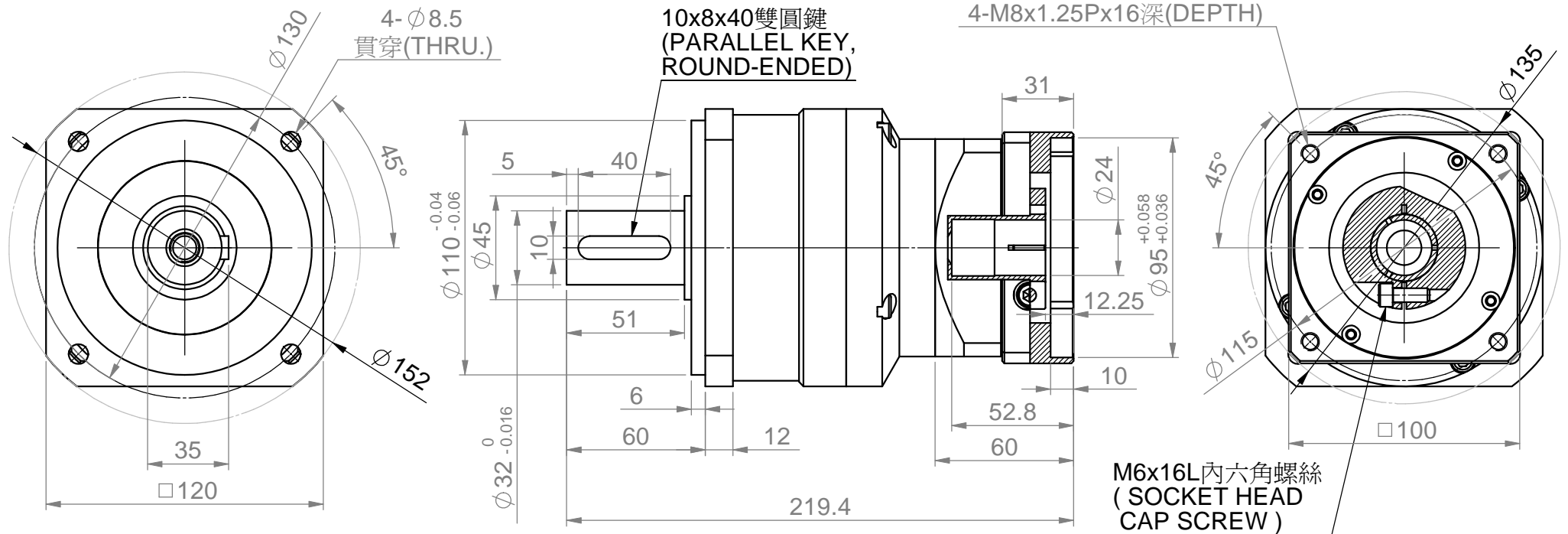

連接板品號
 ADAPTER PART NO.
 234B034316

規格尺寸如有變更,恕不另行通知
 SPECIFICATIONS ARE SUBJECT TO
 CHANGE WITHOUT PRIOR NOTICE

單位 Unit	mm	機型 Model Name	PGE/PEE120T 雙段 PGE/PEE120T 2 STAGE
投影法 Project		圖號 Drawing No.	3D4YT.095100.042



世協電機股份有限公司
 SESAME MOTOR CORP.