

適用馬達尺寸 / COMPATIBLE MOTOR DIMENSIONS

A	B	C	D	E	F	H	L
≤24	110	≤58.2	≤9	145	8.1~10	120~140	≥C-19

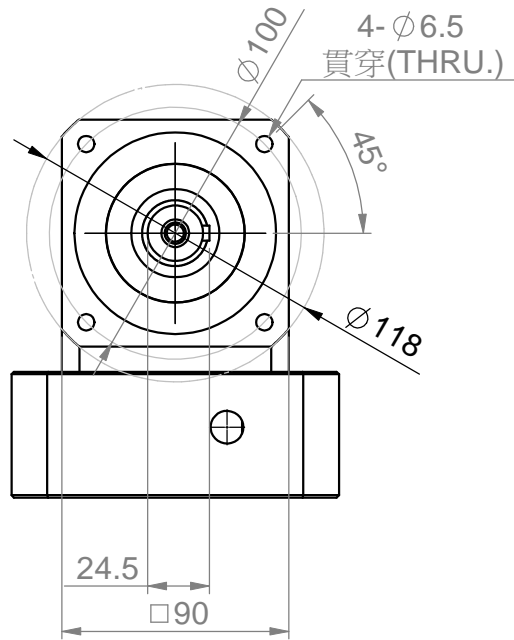

※馬達出力軸小於24時,附襯套  
BUSHING WILL BE SUPPLIED WHEN THE MOTOR  
SHAFT DIAMETER IS SMALLER THAN 19

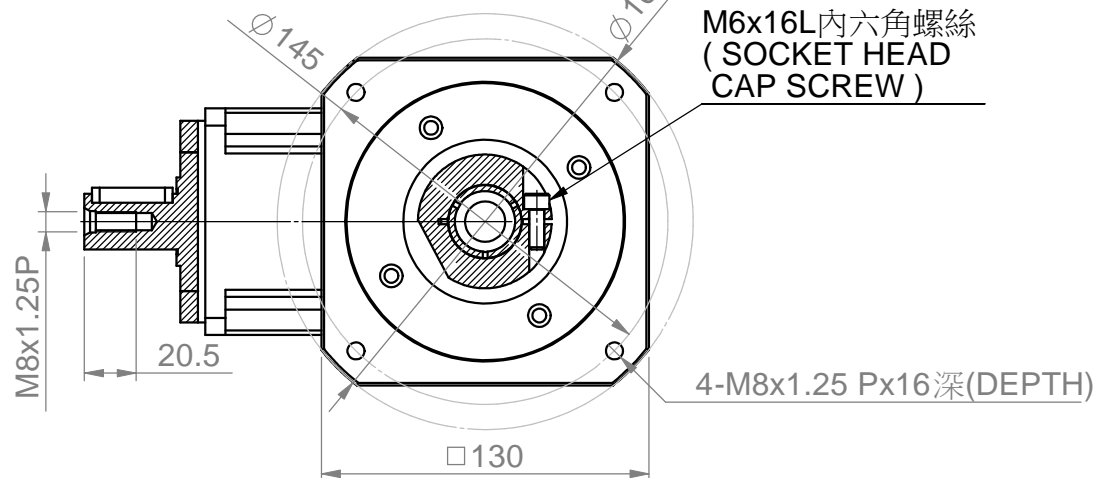
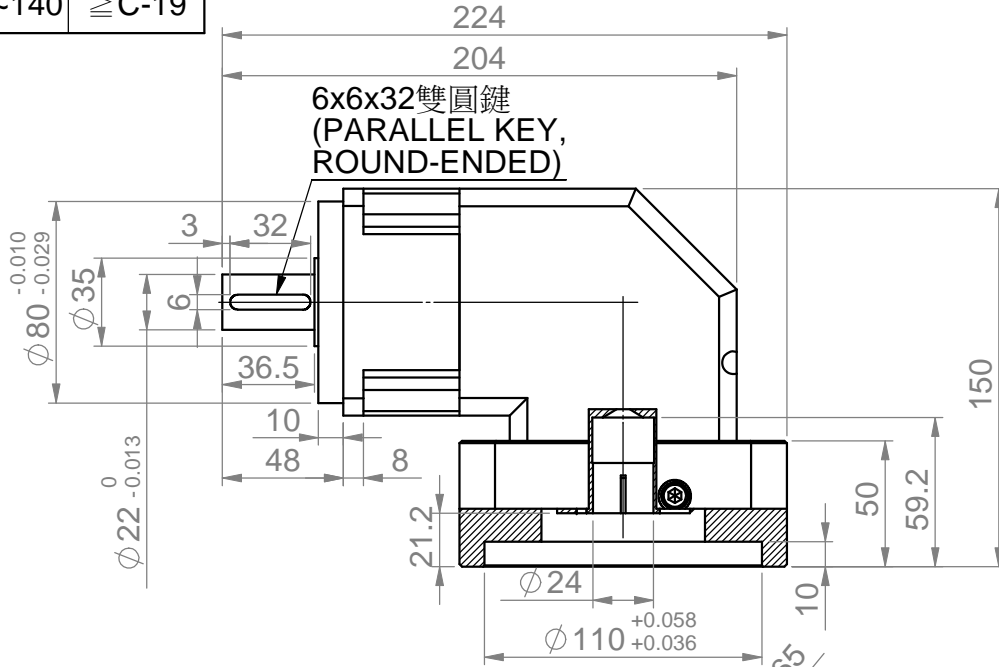

連接板品號  
ADAPTER PART NO.  
2341435501

規格尺寸如有變更,恕不另行通知  
SPECIFICATIONS ARE SUBJECT TO  
CHANGE WITHOUT PRIOR NOTICE

單位 Unit	mm	機型 Model Name	PGRH90 單段 PGRH90 1 STAGE
投影法 Project		圖號 Drawing No.	6A3YS.110130.144



世協電機股份有限公司  
SESAME MOTOR CORP.